

Relay modules

relais

Introduction to relay technology

Modular DIN rail mounted relays

Plug-in DIN rail mounted relays

Multiple chassis mounted relays

Timer relays

The relay modules offer features such as

- Overall width of 6,2 mm
- Screw or spring-clamp connection
- Separation into input or output relays
- Multipole relay modules
- 4 kV isolation at a creepage and clearance distance of 8 mm
- Timer relay with ON delay
- Multi function time relay
- Solid state relays

In general all Wieland components which are obliged to have the CE identification are provided with the CE mark

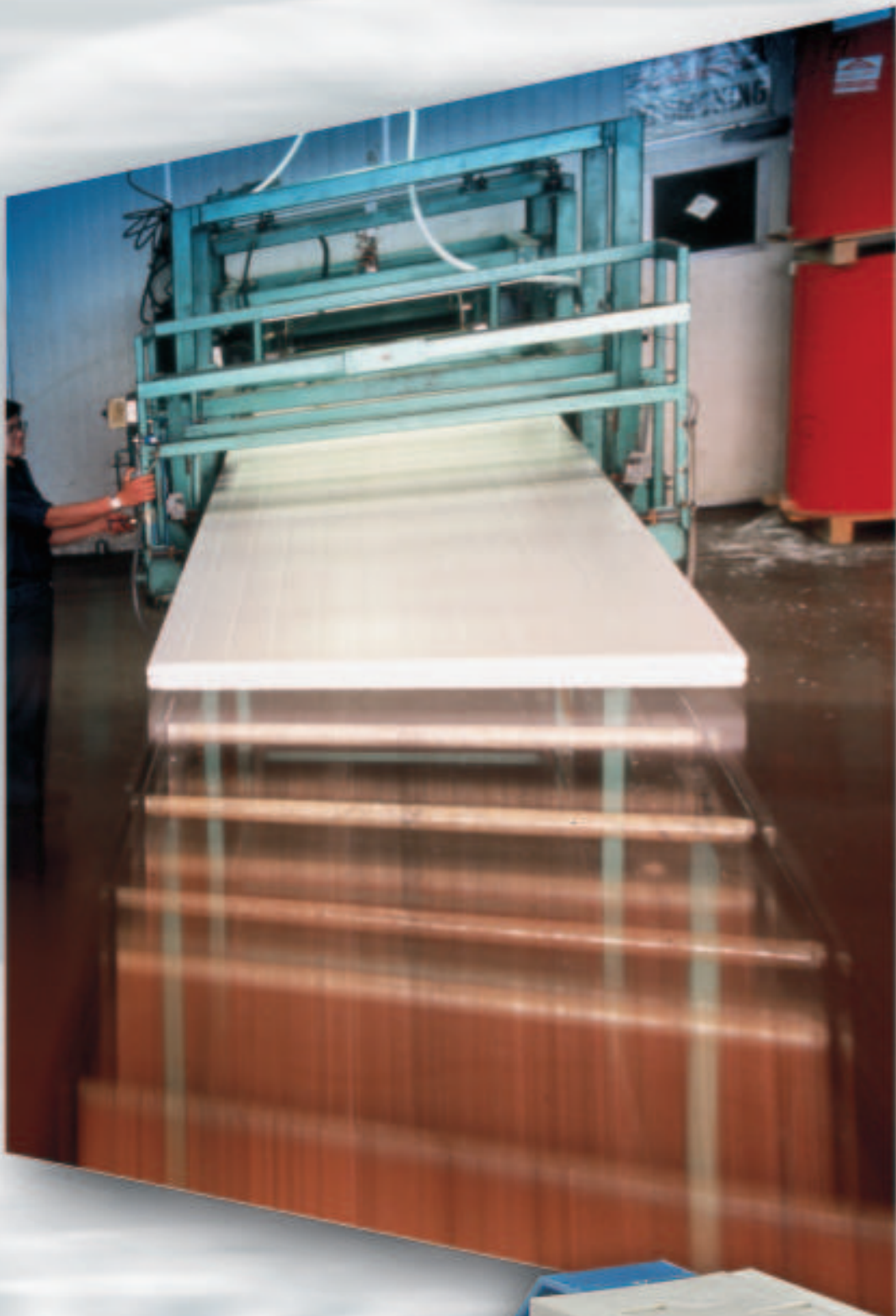

Electronic components

Relay modules



Relay modules

relais

Wieland relay modules – the reliable way to implement an application-related interface

In the microchip age, many believed that electromechanical relays would no longer play a role. This is however far from the truth. Switching relays have reliably carried out important tasks for many years, working in a “symbiotic relationship” with the electronics. Relays have demonstrated a high degree of flexibility over the years. The core characteristics have been maintained or even improved such as:

- ❑ Overload capability without costly protection measures
- ❑ Contact rating of μA up to $>10\text{ A}$
- ❑ Various types and number of the contacts
- ❑ High level of insensitivity to electrical interference
- ❑ Switching without dependence on the direction of current (AC/DC) up to the GHz range
- ❑ Low level of switching power loss
- ❑ Electrical isolation between all contacts and the coil

Wieland offers a complete range of relay modules with a combination of properties outlined above. Depending on the required applications, relay modules are available with various operating voltages, contact arrangements, contact materials and housing designs. Timer relays or HAND-0-AUTO relays can be supplied in addition to relays with pure monostable functionality.

Product range:

flare MOVE, Plug-in, process interface relay with an overall width of 6.2 mm

flare, Process interface relay / time relay with an overall width of 6.2 mm

WEG, Switching relay modules with an overall width up to 22.5 mm

WR, WRS, RAB, Multipole switching relay modules with mounting base

Overview of the technical data

Control side – operating voltage

Wieland relay modules can be controlled within a defined temperature range, given operating voltage and relevant tolerance band to a 100% duty cycle.

Control side – RC circuit

The relay modules can be controlled with direct or alternating voltage depending on the type. Direct voltage relays are equipped accordingly with a polarised diode and a free-wheeling diode in the input. These functions are taken over by a power rectifier in the case of AC or AC/DC modules. All relay modules have an LED for status display in the input circuit.

RC circuit of input for DC operation

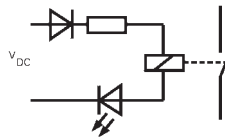

RC circuit of input for AC operation

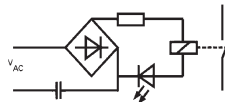

Control side – residual voltage

To ensure the safe operation of the relay the residual voltage in the coil circuits must not exceed 5% DC and 15% AC of the operating voltage in accordance with VDE 0435. Values above this will result in the relay remaining closed after switch off.

Residual voltages can occur from semiconductor devices in circuit, induced voltages from high current cabling or other inductive or capacitive interference factors.

Corrective measures may involve the re-routing of cables away from interference or the parallel connection of RC elements.

Load side – contact material

The contacts are used to route control signals in a power range of mW up to more than 1000 VA. The contact material that is used is largely determined by the load expected during operation (particularly with regard to current carrying capacity, switching frequency, operating speed as

well as any corrosive environmental influences). Wieland uses the universally accepted AgSnO contacts for power ranges up to 1500 VA. In the lower power range, the same material is used but with a gold-plated finish.

Modules with gold-flashed AgCu contacts, AgCdO or gold-plated AgNi contacts are also available. Table 1 gives an overview of other contact materials.

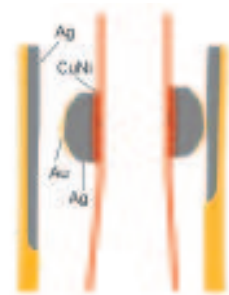

Cut-out of a 3-layer welded contact with a linear contact closure

relais

Contact material	Attacked by		Typical properties	Typical applications	Scope
	Sulphur	Oxidisation			
Gold silver AuAg10	no	no	Low and constant contact resistance at minimum switching capacity	Dry switching circuits, measuring circuits, unfiltered communication routes	mV...60 V mA...300 mA
Gold nickel AuNi5	no	slightly	Free of material transfer in broad loading ranges, small contact resistance, slight electric arcs occur at low switching capacities, higher number of operations and greater contact follow-through, interference possible due to friction oxides	Used in low and medium voltage and current ranges	100 mV...60 V 1 mA...300 mA
Fine grained silver AgNi0,15	yes	no	Higher mechanical strength, low welding tendency and higher arc resistance than Ag, relatively smaller contact resistance	Universal use in medium-sized loads at higher voltage than gold nickel	>12 V 1 mA...1 A
Hard silver AgCu3	yes	when switching	Higher mechanical strength, low welding tendency and higher arc resistance than fine silver but a greater contact resistance	Used in medium-sized loads	>12 V 10 mA...10 A
Silver nickel AgNi10	yes	no	Higher arc resistance, low welding tendency, greater contact resistance	Switching circuits for medium to high loads, d.c. circuit	>17 V >5 mA
Silver cadmium Oxid AgCdO10	yes	no	Low welding tendency, high arc resistance at greater switching capacities	Particularly suitable for switching inductive loads	>12 V >100 mA
Silver tin oxide AgSnO10	yes	no	Low welding tendency, very high arc resistance at high switching capacities, low rate of material transfer	Switching circuits with high loads during opening and closing, d.c. circuits	>17 V >5 mA
AgNi0,15+ 5 µ Au	no	yes	Good corrosion properties, good contact resistance	Small switching capacities for dry circuits	µV...30 V µA...200 mA
AuAg10 over AgNi+Au	no	yes	Behaves as 5 m gold contact but its resistance to wear is five times greater	Minimum switching capacities up to 100 W or 1 kVA	ab 100 mV ab 10 µA

Table 1: Overview of contact materials

Contact side – reduction of arcs

When the arc limit voltage (see diagram) which is dependent on the switching current and contact material is exceeded, discharge processes take place on the relay contact. Material transfer occurs which damages the contact. To achieve a long service life and a high level of reliability despite this type of contact loading, circuit elements are required for arc suppression. Several options are available.

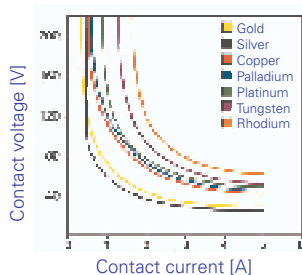

Arc limit of pure contact metals

D.C. circuits with a resistive load

An RC element which is connected in parallel to the contact can be used for arc suppression.

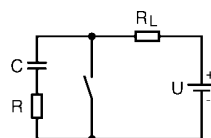

RC element parallel

At the point of disconnection, the voltage U_c at the contact jumps from zero to the value $U \times R / (R + R_L)$ and then rises according to the function $U_c = U (1 - e^{-t/\tau})$ whereby $\tau = (R + R_L) \times C$. The resistance R must be high enough so that the combined total of the condenser discharge current and the switching current at start-up is less than the maximum permitted starting current.

$$R > U / (I_{zul} U / R)$$

At a switching frequency $1/T$, the capacitor should have discharged its load again before the contact is reopened. This is essentially guaranteed if $C < T / 2R$ has been selected.

D.C. circuits with an inductive load

While the maximum switching voltage U is applied when a resistive load is present at the contact, voltage peaks that are approximately 10 times as high can occur in the case of an inductive load.

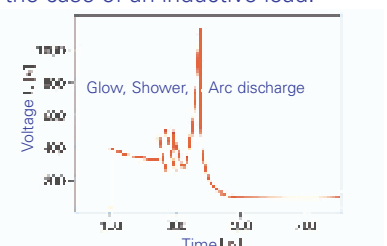

Voltage characteristics at the relay contact for inductive loads

Relay modules

relais

To avoid harmful discharge processes, it is necessary to prevent a sudden disruption in the flow of current and simultaneously ensure that the voltage rise at the contact, which is limited by the degradation of the magnetic field, takes place at a slower rate than the opening of the contact. This counteracts the occurrence of a discharge process and an air gap is therefore created as quickly as possible after the opening of the contact whose igniting voltage far exceeds the voltage building up at the contacts. An RC element which lies parallel to the contact can also be used for this purpose.

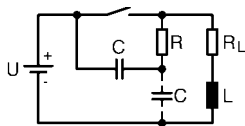

RC element for inductive load

When the contact opens, a charging current which is subsiding after an e function, flows into the capacitor. This slows down the absorption of the current that is flowing through the inductor and the peak value of the voltage at the contact is simultaneously reduced. The following serves as a practical, approximate value for the rating of the capacitor

$$C (\mu F) \cong I^2 / 10 (A)$$

where I represents the respective switching current. The resistance must be rated so that the combined total of the capacitor discharge current and the switching current is again less than the permitted starting current.

Another possibility is the parallel connection of an RC element to the load itself (see diagram above). This protective measure is equally effective. The disadvantage of both arrangements is the use of relatively large and therefore expensive capacitors.

RC circuit for a.c. load

A VDR resistor (Voltage Dependent Resistor) or varistor can be connected in parallel to the load in this application in order to protect the contact. The resistance of this component is low for high voltage levels and high for low voltage levels. Varistors are therefore extremely suitable for the suppression of arcs in a.c. circuits. Table 2 gives an overview of further possibilities for arc suppression.

Protective circuit for load	Additional dropout delay	Defined limit for induced voltage	Bipolar attenuation	Benefits / Disadvantages
Diode	long	yes (U_D)	no	Benefits: Simple implementation Cost effective Reliable Non-critical dimensioning Small induced voltage Disadvantages: Attenuation only via load resistance Long dropout delay
Series-connected diode / Zener diode	medium to short	yes (U_{ZD})	no	Benefit: Non-critical dimensioning Disadvantage: Attenuation only above U_{ZD}
Suppressor diode	medium to short	yes (U_{ZD})	yes	Benefits: Cost effective Non-critical dimensioning Suitable for AC voltage Limit of positive peaks Disadvantage: Attenuation only above U_{ZD}
Varistor	medium to short	yes (U_{VDR})	yes	Benefits: High absorption of energy Non-critical dimensioning Suitable for AC voltage Disadvantage: Attenuation only above U_{VDR}
RC Combination	medium to short	no	yes	Benefits: HF attenuation of stored energy Suitable for AC voltage Attenuation is not dependent on the level Disadvantages: Exact dimensioning required High inrush current Sensitive to harmonic waves

Table 2: Overview of protective measures on the switch output

Diode:

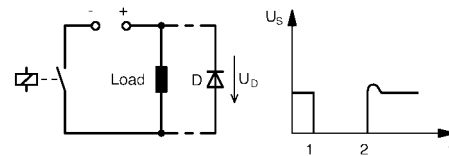

Benefit: Can be used for all capacities, low overvoltage, compact, cost-effective
Disadvantage: Very high resetting time

Varistor:

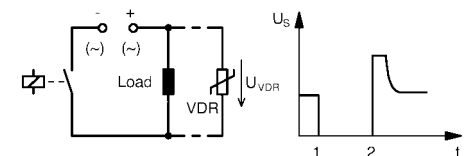

Benefit: Low resetting time, cost-effective
Disadvantage: Cannot be used for all operating voltages and capacities

Diode and Zener diode:

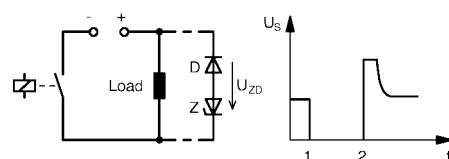

Benefit: Low overvoltage (defined by Zener diode), low resetting time

Disadvantage: Cannot be used for large capacities

RC combination:

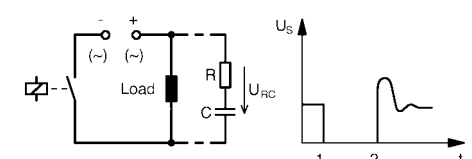

Benefit: Low overvoltage, low resetting time

Disadvantage: High current loading of the contacts at start-up, more costly and time-consuming with increased capacity

relais

Endurance

A distinction is made in relay modules between mechanical and electrical endurance. The mechanical endurance defines the maximum number of operating cycles without contact loading while the electrical endurance describes the switching frequency at a maximum switching capacity for resistive load. A low switching capacity increases these values considerably. The following diagram indicates the typical waveform between the switching current and endurance of a relay. Figures for each relay module is shown on the relevant catalogue data page.

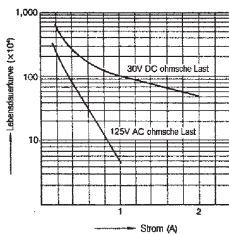

Typical endurance curve of a relay

Safety separation – VDE 0106

The safety separation of coupled switching circuits in the relay modules means that the isolating voltage between the control and load circuit is retained even in the event of a mechanical failure (bent soldered pin, broken coil winding or spring). When using solid-state relays or electronic relays, this requirement is met using double or reinforced insulation. The norms DIN 50178, VDE 0106 and 109 form the basis for safety separation. VDE 0884 also applies to solid-state relays.

All Wieland modules meet these requirements.

Timer relay modules

Wieland timer relays are electromechanical relays with an integrated time response. The time response is defined according to VDE 0435 section 201/5.83. The respective time range is either fixed or set via a DIP switch depending on the type. Fine-tuning within the time range can also be carried out via a potentiometer. An integrated LED indicates the switching state of the relay.

Definition of the time response

On delay

Operating voltage is applied; the relay switches to operating position after a set delay.

Off delay with control voltage

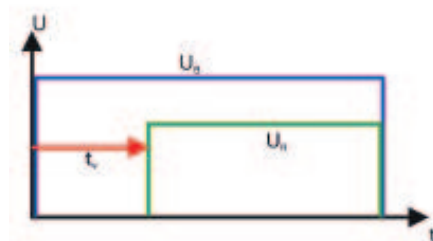

Operating voltage is applied; the relay remains in normal position

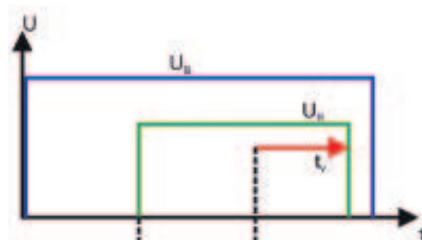

Control voltage is applied; the relay switches to operating position

Control voltage is interrupted; time delay is activated; the relay drops out after the period has elapsed.

Interval timer

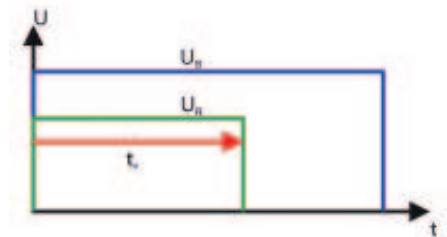

Operating voltage is applied; the relay switches to operating position and drops out after the set period

Flashing pulse start

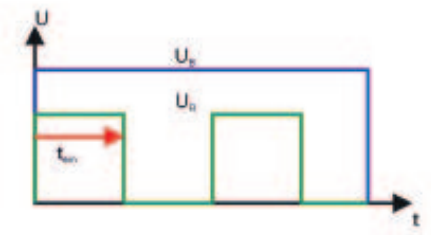

Operating voltage is applied; relay starts clock pulse operation over the set period; relationship between pulse and pause is 1:1

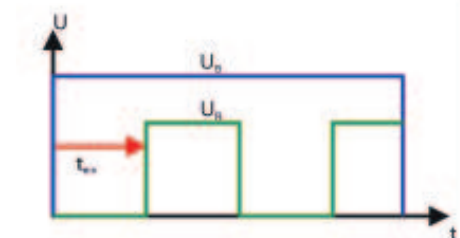

Flashing pause start

Operating voltage is applied; relay starts clock pause operation over the set period; relationship between pulse and pause is 1:1

Relay modules

flare



250 V AC / 300 V DC, 6 A 1 Changeover contact

Approvals: , CSA



48 V DC, 20 mA 1 Changeover contact

Approvals: , CSA

Overall width 6.2 mm
Screw or spring clamp terminal
can be selected
Dimensions (mm): W x H x D
6.2 x 89 x 70

Operating voltage	Screw terminal	Spring-clamp	Box Qty	Screw terminal	Spring-clamp	Box Qty
12 V DC		80.010.4106.0	10			
24 V DC	80.010.4000.0	80.010.4100.0	10			
12 V AC/DC						
24 V AC/DC				80.010.4005.0	80.010.4105.0	10
115 V AC		80.010.4131.0	10			
230 V AC		80.010.4141.0	10			
Wiring diagram, derating curve, limit curve	See pages 464-465			See pages 464-465		
Coil circuit						
Operating voltage	UB +25 %/-20 %			UB +25 %/-20 %		
Nominal input current	ca. 14 mA			ca. 14 mA		
Nominal input capacity	ca. 0.35 W			ca. 0.35 W		
Holding current at 20 °C	> 1,2 mA			> 1,2 mA		
Connectable via plug-in jumper	Up to 50 modules			Up to 50 modules		
Status display	LED Green			LED Green		
Switching characteristics						
Maximum switching voltage	250 V AC / 300 V DC			48 V DC		
Maximum switching current	6 A AC / 2 A DC			20 mA		
Maximum switching capacity	1500 VA / 48 W			1 W		
Maximum starting current	10 A; 4 sec.					
Pickup/dropout delay	8 ms / 10 ms			8 ms / 10 ms		
Chatter time	2 ms			2 ms		
Maximum switching frequency	20 Hz			20 Hz		
Contact material	AgSnO ₂			AgSnO ₂ + 3µ Au		
Minimum switchable voltage	12 V			5 V		
Minimum switchable current	5 mA			1 mA		
Mechanical endurance	2 x 10 ⁷			2 x 10 ⁷		
Electrical endurance 24 V DC / 2 A	6 x 10 ⁵			6 x 10 ⁵		
Electrical endurance 230 V AC / 6 A	8 x 10 ⁴			8 x 10 ⁴		
Rated voltage						
Isolation voltage of input/output	4 kV _{eff.}			4 kV _{eff.}		
Overvoltage category	III (according to HD 625.1S1)			III (according to HD 625.1S1)		
Degree of pollution	2 (according to HD 625.1S1)			2 (according to HD 625.1S1)		
Ambient temperature	0 °C...+50 °C			0 °C...+50 °C		
Storage temperature	-40 °C...+55 °C			-40 °C...+55 °C		
Protection type/mounting rail	IP 20 / TS35			IP 20 / TS35		
Norms/specifications	VDE 0160; VDE 0106 T101			VDE 0160; VDE 0106 T101		
Emitted interference/interference immunity	EN 61000-6-3; EN 61000-6-2			EN 61000-6-3; EN 61000-6-2		
Wire range of screw terminal/spring clamp terminal						
finely stranded	0.14 mm ² – 1.5 mm ²			0.14 mm ² – 1.5 mm ²		
single core	0.5 mm ² – 2.5 mm ²			0.5 mm ² – 2.5 mm ²		
CSA EX approval	Class I, Division 2, Groups A, B, C and D			Class I, Division 2, Groups A, B, C and D		
Accessories						
Plug-in jumper (U _{max} = 50 V, I _{max} = 2 A)	Z8.000.0200.8			Z8.000.0200.8		
8 digit marker tag, unmarked, 60 off	Z4.242.5153.0			Z4.242.5153.0		
Comb for potential distribution, red/blue	Z8.000.0202.3 / Z8.000.0202.4			Z8.000.0202.3 / Z8.000.0202.4		
End caps for comb red/blue	Z8.000.0202.1 / Z8.000.0202.2			Z8.000.0202.1 / Z8.000.0202.2		

flare



Overall width 12.4 mm
Spring clamp

Dimensions (mm): W x H x D
6.2 x 89 x 70

250 V AC / 300 V DC, 6 A
2 Changeover contacts

Approvals: , CSA

Operating voltage	Screw terminal	Spring-clamp	Box Qty
12 V DC			
24 V DC		80.010.4103.0	10
12 V AC/DC			
24 V AC/DC			
115 V AC			
230 V AC			
Wiring diagram, derating curve, limit curve	See pages 464-465		
Coil circuit			
Operating voltage	UB +25 %/-20 %		
Nominal input current	ca. 14 mA		
Nominal input capacity	ca. 0.35 W		
Holding current at 20 °C	> 1.2 mA		
Connectable via plug-in jumper	Up to 50 modules		
Status display	LED Green		
Switching characteristics			
Maximum switching voltage	250 V AC / 300 V DC		
Maximum switching current	6 A AC / 2 A DC		
Maximum switching capacity	1500 VA / 48 W		
Maximum starting current	10 A; 4 sec.		
Pickup/dropout delay	8 ms / 10 ms		
Chatter time	2 ms		
Maximum switching frequency	20 Hz		
Contact material	AgSnO ₂		
Minimum switchable voltage	24 V		
Minimum switchable current	5 mA		
Mechanical endurance	2 x 10 ⁷		
Electrical endurance 24 V DC / 2 A	6 x 10 ⁵		
Electrical endurance 230 V AC / 6 A	8 x 10 ⁴		
Rated voltage			
Isolation voltage of input/output	4 kV _{eff}		
overvoltage category	III (according to HD 625.1S1)		
Degree of pollution	2 (according to HD 625.1S1)		
Ambient temperature	0 °C...+50 °C		
Storage temperature	-40 °C...+55 °C		
Protection type/mounting rail	IP 20 / TS35		
Norms/specifications	VDE 0160; VDE 0106 T101		
Emitted interference/interference immunity	EN 61000-6-3; EN 61000-6-2		
Wire range of screw terminal/spring clamp terminal			
finely stranded	0.14 mm ² – 1.5 mm ²		
single core	0.5 mm ² – 2.5 mm ²		
Accessories			
Plug-in jumper (U _{max} = 50 V, I _{max} = 2 A)	Z8.000.0200.8		
8 digit marker tag, unmarked, 60 off	Z4.242.5153.0		
Comb for potential distribution, red/blue	Z8.000.0202.3 / Z8.000.0202.4		
End caps for comb red/blue	Z8.000.0202.1 / Z8.000.0202.2		

Relay modules

Plug-in relays

flare MOVE



Overall width: 6.2 mm
plug-in relay, screw clamp

Dimensions (mm): W x H x D
6.2 x 88 x 76

Coil voltage 12 V AC/DC
Output 250 V AC / 6 A
1 Changeover contact

Coil voltage 24 V AC/DC
Output 250 V AC / 6 A
1 Changeover contact

Operating voltage	AgSnO ₂	AgSnO ₂ + Au (5 μ)VPE	AgSnO ₂	AgSnO ₂ + Au (5 μ) VPE		
12 V DC relay	80.063.4031.0	80.063.4031.1 10				
24 V DC relay			80.063.4032.0	80.063.4032.1 10		
60 V DC relay						
Coil circuit (identical for both types of contact material)						
Nominal operating voltage	12 V DC	12 V AC/DC	24 V DC	24 V AC/DC		
Maximum operating voltage	16.8 V DC	16.8 V DC	33.6 V DC	33.6 V DC		
Minimum operating voltage	8.4 V DC	9.1 V DC	16.8 V DC	18.2 V DC		
Nominal input current	15.2 mA	15.2 mA	9.4 mA	9.4 mA		
Nominal input capacity AC/DC	0.2 W	0.25 VA	0.23 W	0.3 VA		
Operating range	(0.7...2.2) U _N	(0.85...1.1) U _N	(0.7...2.2) U _N	(0.85...1.1) U _N		
Connectable via plug-in jumper	Up to 20 modules		Up to 20 modules			
Status display	LED Green		LED Green			
Switching characteristics	AgSnO₂	AgSnO₂ + Au (5 μ)	AgSnO₂	AgSnO₂ + Au (5 μ)		
Maximum switching voltage	400 V AC		400 V AC			
Nominal switching voltage	250 V AC		250 V AC			
Maximum switching current	6 A AC/DC		6 A AC/DC			
Maximum switching capacity	1500 VA / 150 W		1500 VA / 150 W			
Maximum starting current	30 A (0.5 sec.)		30 A (0.5 sec.)			
Pickup/dropout delay (including chatter)	7 ms / 11 ms		7 ms / 11 ms			
Maximum switching frequency	20 Hz (without load); 0.1 Hz (at full load)		20 Hz (without load); 0.1 Hz (at full load)			
Contact material	AgSnO ₂	AgSnO ₂ + Au (5 μm)	AgSnO ₂	AgSnO ₂ + Au (5 μm)		
Minimum switchable voltage	12 V AC/DC	5 V AC/DC	12 V AC/DC	5 V AC/DC		
Minimum switchable current	10 mA AC/DC	2 mA AC/DC	10 mA AC/DC	2 mA AC/DC		
Minimum switching capacity	500 mW	50 mW	500 mW	50 mW		
Mechanical endurance	1 x 10 ⁷		1 x 10 ⁷			
Electrical endurance 230 V AC / 6 A	6 x 10 ⁴		6 x 10 ⁴			
Rated voltage	250 V		250 V			
Isolation voltage of input/output	4 kV _{eff.}		4 kV _{eff.}			
Overvoltage category	III (according to HD 625.1S1)		III (according to HD 625.1S1)			
Degree of pollution	2 (according to HD 625.1S1)		2 (according to HD 625.1S1)			
Ambient temperature	0 °C...+50 °C		0 °C...+50 °C			
Storage temperature	-40 °C...+55 °C		-40 °C...+55 °C			
Protection type/mounting rail	IP 20 / TS35		IP 20 / TS35			
Norms/specifications						
Wire range of screw terminal: finely stranded/single core	0.14 mm ² -1.5 mm ² / 0.5 mm ² -2.5 mm ²		0.14 mm ² -1.5 mm ² / 0.5 mm ² -2.5 mm ²			
Accessories	Relay type	Part No.	Box Qty	Relay-Type	Part No.	Box Qty
Relay base for operating voltage (6/12/24) V DC	12 or 24 V DC	80.063.4001.1	10	12 or 24 V DC	80.063.4001.1	10
Relay base for operating voltage (6/12/24) V AC/DC	12 or 24 V DC	80.063.4021.1	10	12 or 24 V DC	80.063.4021.1	10
Relay base for operating voltage (48/60) V AC/DC	60 V DC	80.063.4023.1	10	60 V DC	80.063.4023.1	10
Relay base for operating voltage (110...125) V AC/DC	60 V DC	80.063.4025.1	10	60 V DC	80.063.4025.1	10
Relay base for operating voltage (220...240) V AC/DC	60 V DC	80.063.4026.1	10	60 V DC	80.063.4026.1	10
Insulating plate	IP SF38	80.063.4009.1		IP SF38	80.063.4009.1	
Comb-shaped jumper, continuous current 36 A	KB SF38	80.063.4029.3		KB SF38	80.063.4029.3	
Marker tag (plastic, white)	BZ SF38	80.063.4029.3		BZ SF38	80.063.4029.3	
Labelling mat	BM SF38	80.063.4129.3		BM SF38	80.063.4129.3	

flare MOVE

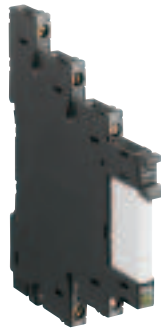

Overall width: 6.2 mm
plug-in relay, screw clamp

Dimensions (mm): W x H x D
6.2 x 88 x 76

Coil voltage 110 V AC/DC
Output 250 V AC / 6 A
1 Changeover contact

Coil voltage 230 V AC/DC
Output 250 V AC / 6 A
1 Changeover contact

Operating voltage	AgSnO ₂	AgSnO ₂ + Au (5 μ)	AgSnO ₂	AgSnO ₂ + Au (5 μ)		
12 V DC relay						
24 V DC relay						
60 V DC relay	80.063.4034.0	80.063.4034.1	80.063.4034.0	80.063.4034.1		
Coil circuit						
Nominal operating voltage	110 V AC/DC (50/60 Hz)		230 V AC/DC (50/60 Hz)			
Maximum operating voltage	132 V AC		255 V AC			
Minimum operating voltage	83.5 V AC		175 V AC			
Nominal input current	3.1 mA		3.1 mA			
Nominal input capacity AC/DC	0.6 VA		0.9 VA			
Operating range	(0.85...1.1) U _N		(0.85...1.1) U _N			
Connectable via a plug-in jumper	Up to 20 modules		Up to 20 modules			
Status display	LED Green		Green LED			
Switching characteristics						
	AgSnO₂	AgSnO₂ + Au (5 μ)	AgSnO₂	AgSnO₂ + Au (5 μ)		
Maximum switching voltage	400 V AC		400 V AC			
Nominal switching voltage	250 V AC		250 V AC			
Maximum switching current	6 A AC/DC		6 A AC/DC			
Maximum switching capacity	1500 VA / 150 W		1500 VA / 150 W			
Maximum starting current	30 A (0.5 sec.)		30 A (0.5 sec.)			
Pickup/dropout delay (including chatter)	7 ms / 11 ms		7 ms / 11 ms			
Maximum switching frequency	20 Hz (without load); 0.1 Hz (at full load)		20 Hz (without load); 0.1 Hz (at full load)			
Contact material	AgSnO ₂	AgSnO ₂ + Au (5 μ)	AgSnO ₂	AgSnO ₂ + Au (5 μ)		
Minimum switchable voltage	12 V AC/DC	5 V AC/DC	12 V AC/DC	5 V AC/DC		
Minimum switchable current	10 mA AC/DC	2 mA AC/DC	10 mA AC/DC	2 mA AC/DC		
Minimum switching capacity	500 mW	50 mW	500 mW	50 mW		
Mechanical endurance	1 x 10 ⁷		1 x 10 ⁷			
Electrical endurance 230 V AC / 6 A	6 x 10 ⁴		6 x 10 ⁴			
Rated voltage	250 V		250 V			
Isolation voltage of input/output	4 kV _{eff}		4 kV _{eff}			
Overvoltage category	III (according to HD 625.1S1)		III (according to HD 625.1S1)			
Degree of pollution	2 (according to HD 625.1S1)		2 (according to HD 625.1S1)			
Ambient temperature	0 °C...+50 °C		0 °C...+50 °C			
Storage temperature	-40 °C...+55 °C		-40 °C...+55 °C			
Protection type/mounting rail	IP 20 / TS35		IP 20 / TS35			
Norms/specifications						
Wire range of screw terminal: finely stranded/single core	0.14 mm ² – 1.5 mm ² / 0.5 mm ² – 2.5 mm ²		0.14 mm ² – 1.5 mm ² / 0.5 mm ² – 2.5 mm ²			
Accessories						
	Relay-Type	Part No.	Box Qty	Relay-Typ	Bestell-Nr.	VPE
Relay base for operating voltage (6/12/24) V DC	12 or 24 V DC	80.063.4001.1	10	12 or 24 V DC	80.063.4001.1	10
Relay base for operating voltage (6/12/24) V AC/DC	12 or 24 V DC	80.063.4021.1	10	12 or 24 V DC	80.063.4021.1	10
Relay base for operating voltage (48/60) V AC/DC	60 V DC	80.063.4023.1	10	60 V DC	80.063.4023.1	10
Relay base for operating voltage (110...125) V AC/DC	60 V DC	80.063.4025.1	10	60 V DC	80.063.4025.1	10
Relay base for operating voltage (220...240) V AC/DC	60 V DC	80.063.4026.1	10	60 V DC	80.063.4026.1	10
Insulating plate	IP SF38	80.063.4009.1		IP SF38	80.063.4009.1	
Comb-shaped jumper, continuous current 36 A	KB SF38	80.063.4029.3		KB SF38	80.063.4029.3	
Marker tag (plastic, white)	BZ SF38	80.063.4029.3		BZ SF38	80.063.4029.3	
Labelling mat	BM SF38	80.063.4129.3		BM SF38	80.063.4129.3	

Relay modules

flare



Overall width 6.2 mm
For input/output separation

Dimensions (mm): W x H x D
6.2 x 89 x 70

Knife-edge disconnect terminal relay

Approvals: , CSA

Hand-O-Auto relay

Approvals: , CSA

Operating voltage	Screw terminal	Spring-clamp	Box Qty	Screw terminal	Spring-clamp	Box Qty
12 V DC						
24 V DC						
12 V AC/DC						
24 V AC/DC		80.010.4120.0	10		80.010.4101.0	10
115 V AC						
230 V AC						
Wiring diagram, derating curve, limit curve	See pages 464-465			See pages 464-465		
Coil circuit						
Operating voltage	UB +25 %/-20 %			UB +25 %/-20 %		
Nominal input current	ca. 14 mA			ca. 14 mA		
Nominal input capacity	ca. 0.35 W			ca. 0.35 W		
Holding current at 20 °C	> 1.2 mA			> 1.2 mA		
Connectable via plug-in jumper	Up to 50 modules			Up to 50 modules		
Status display	LED Green			LED Green		
Switching characteristics						
Maximum switching voltage	250 V AC / 300 V DC			250 V AC / 300 V DC		
Maximum switching current	6 A AC / 2 A DC			6 A AC / 2 A DC		
Maximum switching capacity	1500 VA / 48 W			1500 VA / 48 W		
Maximum starting current	10 A; 4 sec.			10 A; 4 sec.		
Pickup/dropout delay	8 ms / 10 ms			8 ms / 10 ms		
Chatter time	2 ms			2 ms		
Maximum switching frequency	20 Hz			20 Hz		
Contact material	AgSnO ₂			AgSnO ₂		
Minimum switchable voltage	12 V			12 V		
Minimum switchable current	5 mA			5 mA		
Mechanical endurance	2 x 10 ⁷			2 x 10 ⁷		
Electrical endurance 24 V DC / 2 A	6 x 10 ⁵			6 x 10 ⁵		
Electrical endurance 230 V AC / 6 A	8 x 10 ⁴			8 x 10 ⁴		
Rated voltage						
Isolation voltage of input/output	4 kV _{eff.}			4 kV _{eff.}		
Overvoltage category	III (according to HD 625.1S1)			III (according to HD 625.1S1)		
Degree of pollution	2 (according to HD 625.1S1)			2 (according to HD 625.1S1)		
Ambient temperature	0 °C...+50 °C			0 °C...+50 °C		
Storage temperature	-40 °C...+55 °C			-40 °C...+55 °C		
Protection type/mounting rail	IP 20 / TS35			IP 20 / TS35		
Norms/specifications	VDE 0160; VDE 0106 T101			VDE 0160; VDE 0106 T101		
Emitted interference/interference immunity	EN 61000-6-3; EN 61000-6-2			EN 61000-6-3; EN 61000-6-2		
Wire range of screw terminal	-			-		
Wire range of spring clamp terminal						
finely stranded	0.14 mm ² – 1.5 mm ²			0.14 mm ² – 1.5 mm ²		
single core	0.5 mm ² – 2.5 mm ²			0.5 mm ² – 2.5 mm ²		
CSA EX approval in range	Class I, Division 2, Groups A, B, C and D			Class I, Division 2, Groups A, B, C and D		
Accessories						
Plug-in jumper (U _{max.} = 50 V, I _{max.} = 2 A)	Z8.000.0200.8			Z8.000.0200.8		
8 digit marker tag, unmarked, 60 off	Z4.242.5153.0			Z4.242.5153.0		
Comb for potential distribution, red/blue	Z8.000.0202.3 / Z8.000.0202.4			Z8.000.0202.3 / Z8.000.0202.4		
End caps for comb, red/blue	Z8.000.0202.1 / Z8.000.0202.2			Z8.000.0202.1 / Z8.000.0202.2		



Overall width 22.5mm
Screw clamp

250 V AC / 250 V DC 4 A 2 Changeover contact

Approvals:
22.5 x 58 x 90.5

Dimensions (mm): W x H x D

Operating voltage	Type	Part No.	Box Qty
24 V AC/DC	WEG-REL-2W-250V5A	57.800.7053.0	1
48 V AC/DC			
115 V AC/DC			
230 V AC			
Wiring diagram, derating curve, limit curve	See pages 466-467		
Coil circuit			
Operating voltage	22 V AC/DC		
Nominal input current	31 mA AC / 29 mA DC		
Nominal input capacity	0.75 VA / 0.7 W		
Holding current at 20 °C	4.7 mA AC / 3.6 mA DC		
Switching characteristics			
Maximum switching voltage	250 V AC / 250 V DC ¹⁾		
Maximum starting current	4 A AC/DC ¹⁾		
Maximum switching capacity	1100 VA / 140 W ¹⁾		
Maximum continuous current	15 A AC (200 ms)		
Pickup/dropout delay approx.	16 ms / 20 ms		
Chatter time	3 ms		
Maximum switching frequency			
Contact material	AgCu ₃ + 0,2 μ Au		
Minimum switchable voltage	12 V DC		
Minimum switchable current	10 mA		
Mechanical endurance	> 3 x 10 ⁷		
Electrical endurance at 24 V DC / 1 A	> 2 x 10 ⁶		
Electrical endurance at 230 V AC / 3 A	> 6 x 10 ⁵		
Rated voltage			
Isolation voltage of input/output	2 kV _{eff}		
Overvoltage category			
Degree of pollution			
Ambient temperature	-25 °C...Derating		
Storage temperature	-40 °C...+85 °C		
Protection type/mounting rail	IP 20/TS 32 or TS 35		
Norms/specifications			
Emitted interference/interference immunity			
Wire range, finely stranded/single core	0.14 mm ² – 4 mm ² / 0.14 mm ² – 6 mm ²		
Location of mounting rail	horizontal		
Accessories			
¹⁾ see limit curve on page 465			

Relay modules

for current signals – 4...20 mA – 0...20 mA

current relay



Overall width 22.5mm
Screw clamp

380 V AC / 125 V DC 7 A
1 Changeover contact

Approvals: , CSA
22.5 x 58 x 90.5

Dimensions (mm): W x H x D

Description	Type	Part No.	Box Qty
0-20mA Trip Amplifier Relay	SR 4...20 mA	57802.3053.0	1
1 set point			
Wiring diagram	See page 468		
Coil circuit			
Operating voltage with filtering	9,5 V...40 V		
Operating voltage without filtering	8 V...27 V		
Nominal input current at 40 V	with relay off ca. 7 mA with relay on ca. 35 mA		
Current input R, 100 Ω (max. 7 V)	4...20 mA		
Switching threshold (adjusted with potentiometer)	2...20 mA		
Residual ripple I_{max} at measured current 22 mA	5 mA _{SS} / 5 mA _{pp}		
Residual ripple I_{max} at measured current 2 mA	0.5 mA _{SS} / 0.5 mA _{pp}		
Switching hysteresis	ca. 0.4 mA		
Switching characteristics			
Maximum switching voltage	380 V AC / 125 V DC		
Maximum switching current	7 A		
Maximum switching capacity	1750 V A / 210 W		
Permitted minimum load	5 V DC / 10 mA		
Nominal current load	250 V AC, 7 A / 30 V DC, 7 A		
Isolation voltage of input/output	250 V _{eff}		
Isolation voltage of terminal TS	2 kV _{eff}		
Overvoltage category	III		
Degree of pollution	2		
Ambient temperature, connected in series without intervals	0 °C...50 °C		
Ambient temperature, connected in series with interval of 2 cm	0 °C...60 °C		
Storage temperature	-40 °C...+85 °C		
Protection type/mounting rail	IP 20/TS 35		
Norms/specifications	horizontal		
Location of mounting rail	horizontal		
Accessories			

Relay modules

RAB

Relay output modules

- 1 relay
- 4 relay
- 8 relay
- 16 relay



**250 V AC / 24 V DC 5 A
1 Changeover contact**

Approvals:
12.5 x 80 x 58.3

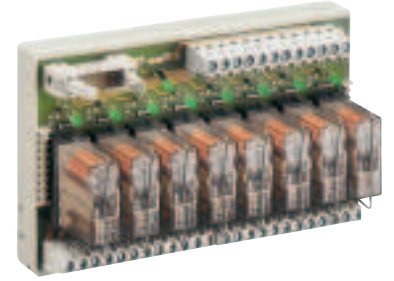

**250 V AC / 24 V DC 5 A
1 Changeover contact**

Approvals:
70/128/280 x 80 x 71

Dimensions (mm): W x H x D

Description	Type	Part No.	Box Qty	Type	Part No.	Box Qty
1 relay	R12-12V-1W-250V5A	87.220.7553.0	10			
4 relay positive switching				RAB-SS 4	87.220.1853.0	1
8 relay positive switching				RAB-FSS 8	87.220.1953.3	1
16 relay positive switching				RAB-FSS 16	87.220.2253.3	1
4 relay negative switching				RAB-SS 4 M	87.221.5553.0	1
Wiring diagram, derating curve, limit curve	See page 469			See page 469		
Coil circuit						
Operating voltage	12 V AC/DC ±10%			24 V DC +10%/−15%		
Nominal input current per input	34 mA			25 mA		
Nominal power consumption	0.4 W			0.6 W		
Holding current at 20 °C	> 3.5 mA			> 2 mA		
Status display	LED Green			LED Green		
Switching characteristics						
Maximum switching voltage	250 V AC / ¹⁾ 1V DC			250 V AC / ¹⁾ 1V DC		
Maximum switching current	8 A AC/ ¹⁾ A DC			8 A AC/ ¹⁾ A DC		
Maximum switching capacity	2000 VA / 120 W			2000 VA / 120 W		
Maximum continuous current	5 A AC/DC ¹⁾			5 A AC/DC ¹⁾		
Pickup/dropout delay approx	9 ms / 12 ms			9 ms / 12 ms		
Chatter time	4 ms			4 ms		
Maximum switching frequency	40 Hz			40 Hz		
Contact material	AgCdO			AgCdO		
Minimum switchable voltage	12 V			12 V		
Minimum switchable current	100 mA			100 mA		
Mechanical endurance	3 x 10 ⁷			3 x 10 ⁷		
Electrical endurance at 24 V DC / 5 A	6 x 10 ⁵			6 x 10 ⁵		
Electrical endurance at 230 V AC / 5 A	6 x 10 ⁵			6 x 10 ⁵		
Rated voltage						
Isolation voltage of input/output	4 kV _{eff}			4 kV _{eff}		
Oversvoltage category						
Degree of pollution						
Ambient temperature	−25 °C...Derating			−25 °C...Derating		
Storage temperature	−40 °C...+85 °C			−40 °C...+85 °C		
Mounting rail	TS 32 or TS 35			TS 32 or TS 35		
Norms/specifications						
Emitted interference/interference immunity						
Wire range, finely stranded/single core	0.5 mm ² – 2.5 mm ² / 0.5 mm ² – 4 mm ²			0.5 mm ² – 2.5 mm ² / 0.5 mm ² – 4 mm ²		
Location of mounting rail	horizontal			horizontal		
Accessories						
Replacement relay				Z8.000.0056.9 10		
¹⁾ See limit curve on page 465						

RAB

Relay output modules

- 1 relay
- 4 relay
- 8 relay
- 16 relay

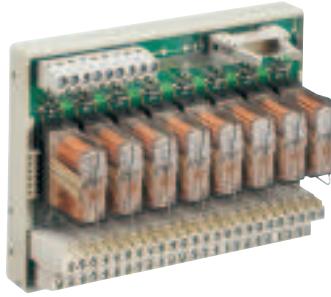

Important note for user:

In the case of multipole modules (1 changeover contact/2 changeover contacts), the outputs must be supplied from the same phase (e.g. L1)

250 V AC / 24 V DC, 5 A 2 Changeover contacts

Approvals:

70/128 x 80 x 71

Dimensions (mm): W x H x D

Description	Type	Part No.	Box Qty
1 relay			
4 relay positive switching	RAB-SS 4/2	87.220.4753.3	1
8 relay positive switching	RAB-SS 8/2	87.220.4853.3	1
6 relay positive switching			
4 relay negative switching			
Wiring diagram, derating curve, limit curve	See page 469		
Coil circuit			
Operating voltage	24 V DC + 10 %/- 15 %		
Nominal input current	25 mA		
Nominal power consumption	0.6 W		
Holding current at 20 °C	> 2 mA		
Status display	LED Green		
Switching characteristics			
Maximum switching voltage	250 V AC / ¹⁾ 1V DC		
Maximum switching current	8 A AC/ ¹⁾ 5 A DC		
Maximum switching capacity	2000 VA / 120 W		
Maximum continuous current	5 A AC/DC ¹⁾		
Pickup/dropout delay approx.	9 ms / 12 ms		
Chatter time	4 ms		
Maximum switching frequency	40 Hz		
Contact material	AgCdO		
Minimum switchable voltage	12 V		
Minimum switchable current	100 mA		
Mechanical endurance	3 x 10 ⁷		
Electrical endurance at 24 V DC / 5 A	6 x 10 ⁵		
Electrical endurance at 230 V AC / 5 A	6 x 10 ⁵		
Rated voltage			
Isolation voltage of input/output	4 kV _{eff}		
Overvoltage category			
Degree of pollution			
Ambient temperature	-25 °C...Derating		
Storage temperature	-40 °C...+85 °C		
Mounting rail	TS 32 or TS 35		
Norms/specifications			
Emitted interference/interference immunity			
Wire range, finely stranded/single-core	0.5 mm ² – 2.5 mm ² / 0.5 mm ² – 4 mm ²		
Location of mounting rail	horizontal		
Accessories			
Replacement relay		Z8.000.0035.5	10
¹⁾ See limit curve on page 465			

Relay modules



Relay modules input/output

- 1 relay
- 4 relay
- 8 relay



250 V AC / 24 V DC 4 A 1 Changeover contact

Approvals:
12.5 x 80 x 70

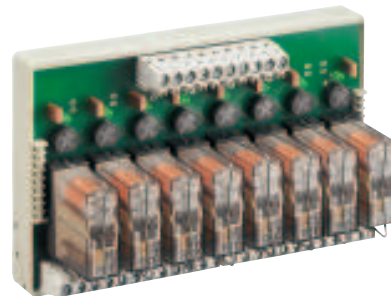

250 V AC / 24 V DC 4 A 1 Changeover contact

Approvals:
70/128 x 80 x 71

Dimensions (mm): W x H x D

Description	Type	Part No.	Box Qty	Type	Part No.	Box Qty
1 relay	WR1-230-1W-250V4A	80.010.0011.0	10			
4 relay				WR4-115-1W-250V4A	80.010.1102.0	1
8 relay				WR8-115-1W-250V4A	80.010.1110.0	1
Wiring diagram, derating curve, limit curve	See pages 470-471			See pages 470-471		
Coil circuit						
Operating voltage	230 V AC +6% / -10%			115 V AC +6% / -10%		
Nominal input current per input	ca. 4.5 mA AC			ca. 8.5 mA AC/DC		
Nominal power consumption	ca. 1.0 VA			ca. 0.95 VA/W		
Holding current at 20 °C	> 0.9 mA AC			> 1.3 mA AC / > 1.0 mA DC		
RC circuit for input	polarised diode, suppressor diode			polarised diode, suppressor diode		
Status display	LED Green			LED Green		
Switching characteristics						
Maximum switching voltage	250 V AC / ¹⁾ V DC			250 V AC / ¹⁾ V DC		
Maximum switching current	8 A AC/ ¹⁾ A DC			8 A AC/ ¹⁾ A DC		
Maximum switching capacity	2000 VA / 192 W			2000 VA / 192 W		
Maximum continuous current	4 A AC/DC			4 A AC/DC		
Pickup/dropout delay approx.	10 ms / 15 ms			12 ms / 13 ms		
Chatter time	4 ms			4,5 ms		
Maximum switching frequency	40 Hz			40 Hz		
Contact material	AgNi + 4...6 µ Au			AgNi 0.15 + 0.2 µ Au		
Minimum switchable voltage	µV			5 V		
Minimum switchable current	µA			10 mA		
Mechanical endurance	3 x 10 ⁷			3 x 10 ⁷		
Electrical endurance at 24 V DC / 4 A	3 x 10 ⁵			3 x 10 ⁵		
Electrical endurance at 230 V AC / 4 A	3 x 10 ⁵			3 x 10 ⁵		
Rated voltage						
Isolation voltage of input/output	4 kV _{eff.}			4 kV _{eff.}		
Oversvoltage category						
Degree of pollution						
Ambient temperature	-25 °C...Derating			-25 °C...+50 °C		
Storage temperature	-40 °C...+80 °C			-40 °C...+80 °C		
Mounting rail	TS 32 or TS 35			TS 32 or TS 35		
Norms/specifications						
Emitted interference/interference immunity						
Wire range, finely stranded/single-core	0.5 mm ² - 2.5 mm ² / 0.5 mm ² - 4 mm ²			0.5 mm ² - 2.5 mm ² / 0.5 mm ² - 4 mm ²		
Location of mounting rail	horizontal			horizontal		
Accessories						
Replacement relay					Z8.000.0181.0	10
¹⁾ See limit curve on page 465						

Relay module input/output

- 1 relay
- 4 relay
- 8 relay

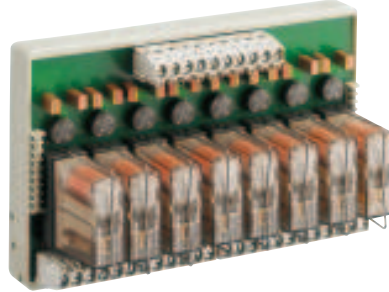

250 V AC / 24 V DC 4 A 1 Changeover contact

Approvals:
70/128 x 80 x71

Dimensions (mm): W x H x D

Description	Type	Part No.	Box Qty
1 relay			
4 relay	WR4-230-1W-250V4A	80.010.1106.0	1
8 relay	WR8-230-1W-250V4A	80.010.1114.0	1
Wiring diagram, derating curve, limit curve	See pages 470-471		
Coil circuit			
Operating voltage	230 V AC/DC +6%/-10%		
Nominal input current per input	approx. 4.5 mA AC/DC		
Nominal power consumption	approx. 1.0 VA/W		
Holding current at 20 °C	> 0.7 mA AC / > 0.5 mA DC		
RC circuit for input	polarised diode, suppressor diode		
Status display	LED Green		
Switching characteristics			
Maximum switching voltage	250 V AC / ¹⁾ V DC		
Maximum switching current	8 A AC / ¹⁾ A DC		
Maximum switching capacity	2000 VA / 192 W		
Maximum continuous current	4 A AC/DC		
Pickup/dropout delay approx.	12 ms / 13 ms		
Chatter time	4.5 ms		
Maximum switching frequency	40 Hz		
Contact material	AgNi 0.15 + 0.2 µ Au		
Minimum switchable voltage	5 V		
Minimum switchable current	10 mA		
Mechanical endurance	3 x 10 ⁷		
Electrical endurance at 24 V DC / 4 A	3 x 10 ⁶		
Electrical endurance at 230 V AC / 4 A	3 x 10 ⁵		
Rated voltage			
Isolation voltage of input/output	4 kV _{eff.}		
Overvoltage category			
Degree of pollution			
Ambient temperature	-25 °C...+50 °C		
Storage temperature	-40 °C...+80 °C		
Mounting rail	TS 32 or TS 35		
Norms/specifications			
Emitted interference/interference immunity			
Wire range, finely stranded/single-core	0,5 mm ² – 2,5 mm ² / 0,5 mm ² – 4 mm ²		
Location of mounting rail	horizontal		
Accessories			
Replacement relay		Z8.000.0181.0	10
¹⁾ See limit curve on page 465			

Relay modules



Relay modules input/output

- 1 relay
- 4 relay
- 8 relay



**250 V AC / 24 V DC 5 A
2 Changeover contacts**

Approvals of the relays:
22.5 x 80 x 68

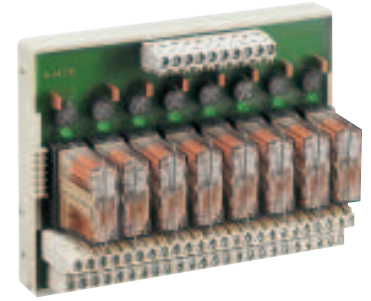

**250 V AC / 24 V DC 4 A
2 Changeover contacts**

Approvals of the relays:
70/128 x 80 x 71

Dimensions (mm): W x H x D

Description	Type	Part No.	Box Qty	Type	Part No.	Box Qty
1 relay	WR1-DUO-2W-250V5A	80.010.1100.0	5			
4 relay				WR4-115-2W-250V4A	80.010.1104.0	1
8 relay				WR8-115-2W-250V4A	80.010.1112.0	1
Wiring diagram, derating curve, limit curve	See pages 470-471			See pages 470-471		
Coil circuit						
Operating voltage	115/230 V AC/DC +6%/-10%			115 V AC/DC +6%/-10%		
Nominal input current per input	ca. 4.8 mA / 4.8 mA AC/DC			ca. 9.5 mA AC/DC		
Nominal power consumption	ca. 0.5 VA/W / 1.1 VA/W			ca. 1.0 VA/W		
Holding current at 20 °C	> 1.0 mA AC / > 0.8 mA DC			> 1.5 mA AC / > 1,0 mA DC		
RC circuit for input	polarised diode, suppressor diode			polarised diode, suppressor diode		
Status display	LED Green			LED Green		
Switching characteristics						
Maximum switching voltage	250 V AC / ¹⁾ V DC			250 V AC / ¹⁾ V DC		
Maximum continuous current	6 A AC/ ¹⁾ A DC			6 A AC/ ¹⁾ A DC		
Maximum switching capacity	1500 VA / 192 W			1500 VA / 192 W		
Maximum switching current	6 A AC/DC (Derating beachten)			4 A AC/DC (Derating beachten)		
Pickup/dropout delay approx.	10 ms / 14 ms			< 12 ms / < 15 ms		
Chatter time	< 3 ms			< 4,5 ms		
Maximum switching frequency						
Contact material	AgNi 0.15 + 0.2 µ Au			AgNi 0,15 + 0,2 µ Au		
Minimum switchable voltage	5 V			5 V		
Minimum switchable current	10 mA			10 mA		
Mechanical endurance	3 x 10 ⁷			3 x 10 ⁷		
Electrical endurance at 24 V DC / 5 A	1,5 x 10 ⁵			1,5 x 10 ⁵		
Electrical endurance at 230 V AC / 5 A	1,5 x 10 ⁵			1,5 x 10 ⁵		
Rated voltage						
Isolation voltage of input/output	4 kV _{eff.}			4 kV _{eff.}		
Overtoltage category						
Degree of pollution						
Ambient temperature	-25 °C...Derating			-25 °C...Derating		
Storage temperature	-40 °C...+85 °C			-40 °C...+80 °C		
Mounting rail	TS 32 or TS 35			TS 32 or TS 35		
Norms/specifications						
Emitted interference/interference immunity						
Wire range, finely stranded/single-core	0.5 mm ² - 2.5 mm ² / 0.5 mm ² - 4 mm ²			0.5 mm ² - 2.5 mm ² / 0.5 mm ² - 4 mm ²		
Location of mounting rail	horizontal			horizontal		
Accessories						
Replacement relay		Z8.000.0176.2	10		Z8.000.0176.2	10
¹⁾ See limit curve on page 465						

Relay modules input/output

- 1 relay
- 4 relay
- 8 relay

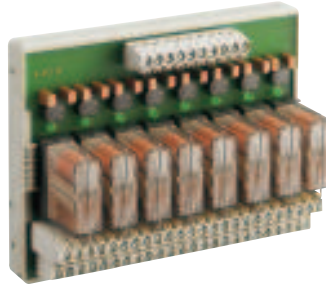

250 V AC / 24 V DC 4 A 2 Changeover contacts

Approvals of the relays:

70/128 x 80 x 71

Dimensions (mm): W x H x D

Description	Type	Part No.	Box Qty
1 relay			
4 relay	WR4-230-2W-250V4A	80.010.1108.0	1
8 relay	WR8-230-2W-250V4A	80.010.1116.0	1
Wiring diagram, derating curve, limit curve			
See pages 470-471			
Coil circuit			
Operating voltage	230 V AC/DC +6%/-10%		
Nominal input current per input	ca. 4.5 mA AC/DC		
Nominal input capacity	ca. 1.0 VA/W		
Holding current at 20 °C	> 0.7 mA AC / > 0.5 mA DC		
RC circuit for input	polarised diode, suppressor diode		
Status display	LED Green		
Switching characteristics			
Maximum switching voltage	0250 V AC / ¹⁾ V DC		
Maximum continuous current	6 A AC / ¹⁾ A DC		
Maximum switching capacity	1500 VA / 192 W		
Maximum switching current	4 A AC/DC (Derating beachten)		
Pickup/dropout delay approx.	< 13 ms / < 16 ms		
Chatter time	< 4,5 ms		
Maximum switching frequency			
Contact material	AgNi 0,15 + 0,2 µ Au		
Minimum switchable voltage	5 V		
Minimum switchable current	10 mA		
Mechanical endurance	3 x 10 ⁷		
Electrical endurance at 24 V DC / 5 A	1.5 x 10 ⁵		
Electrical endurance at 230 V AC / 5 A	1.5 x 10 ⁵		
Rated voltage			
Isolation voltage of input/output	4 kV _{eff}		
Overvoltage category			
Degree of pollution			
Ambient temperature	-25 °C...Derating		
Storage temperature	-40°C...+80 °C		
Mounting rail	TS 32 or TS 35		
Norms/specifications			
Emitted interference/interference immunity			
Wire range, finely stranded/single-core	0.5 mm ² – 2.5 mm ² / 0.5 mm ² – 4 mm ²		
Location of mounting rail	horizontal		
Accessories			
Replacement relay		Z8.000.0176.2	10
¹⁾ See limit curve on page 465			

WRS

- 24 V input signal
- 4 kV separation between I/O at a creepage and clearance distance of 8 mm

High current relay for 16 A



250 V AC/DC 5 A 48 V DC 20 mA
2 Changeover contact

Approvals: CSA,
22.5 x 80 x 60



250 V AC/DC 16 A
1 Changeover contact

Approvals: CSA
22.5 x 80 x 58.3

Dimensions (mm): W x H x D

Description	Type	Part No.	Box Qty	Type	Part No.	Box Qty
WRS Relay system	WRS-REL2W-250V5A	80.010.1003.0	5			
WRS Relay system	WRS-REL2W-48V20M	80.010.1002.0	5			
WRS high-current relay				WRS-REL1W-250V16	80.010.0010.0	5
Wiring diagram, derating curve, limit curve	See pages 472-473			See pages 472-473		
Coil circuit	Output	Input				
Operating voltage	24 V AC/DC +10%/-15%	24 V DC +10%/-15%		24 V AC/DC +10%/-15%		
Nominal input current		25 mA		25 mA		
Nominal power consumption		ca. 0.6 W/VA		ca. 0.6 W/VA		
Holding current at 20 °C		≥ 2 mA		≥ 2 mA		
Parallel connection of max.	20 Relays			20 Relays		
RC circuit of input	RC circuit			Polarised diode		
Status display	LED Green			LED Green		
Switching characteristics	Output	Input				
Maximum switching voltage	250 V AC/DC ²⁾	48 V DC		250 V AC / V DC ²⁾		
Maximum switching current	6 A AC/DC ²⁾	20 mA		16 A AC / V DC ²⁾		
Maximum switching capacity	1500 VA / 144 W	1,2 W		4000 VA / 400 W ²⁾		
Maximum continuous current	5 A AC/DC			16 A AC/DC ²⁾		
Pickup/dropout delay approx.	10 ms / 5 ms	10 ms / 10 ms		10 ms / 5 ms		
Chatter time	3 ms	3 ms		3 ms		
Contact material	AgCdO	AgNi 0.15 + 10 μ Au		AgCdO		
Minimum switchable voltage	12 V	μV		12 V		
Minimum switchable current	100 mA	μA		100 mA		
Mechanical endurance	3 x 10 ⁷	3 x 10 ⁷		3 x 10 ⁷		
Electrical endurance at 26 V DC / 15 mA		3 x 10 ⁵				
Electrical endurance at 24 V DC / continuous current	2,5 x 10 ⁵			1,8 x 10 ⁵		
Electrical endurance at 230 V AC / continuous current	2,5 x 10 ⁵			1,8 x 10 ⁵		
Rated voltage						
Isolation voltage of input/output	4 kV _{eff.}	4 kV _{eff.}		4 kV _{eff.}		
Overvoltage category						
Degree of pollution						
Ambient temperature	-25 °C...+50 °C	-25 °C...+50 °C		-25 °C...Derating		
Storage temperature	-40 °C...+85 °C	-40 °C...+85 °C		-40 °C...+85 °C		
Mounting rail	TS 32 or TS 35			TS 32 or TS 35		
Norms/specifications						
Emitted interference/interference immunity						
Wire range, finely stranded/single-core	0.5 mm ² - 2.5 mm ² / 0.5 mm ² - 4 mm ²			0.5 mm ² - 2.5 mm ² / 0.5 mm ² - 4 mm ²		
Location of mounting rail	horizontal			horizontal		
Accessories						
Plug-in jumper (I _{max} = 0.5 A AC/DC)		Z8.000.0103.4	10	Z8.000.0103.4	10	
²⁾ see d.c. limit curve and derating curve on page 471						

Relay modules

Timer relay

flare

Multifunction timer relay

- on delay
- interval timer
- flashing pause start
- flashing pulse start
- off delay
- timer range 0.1 sec – 300 sec

Timer relay on delay

- timer range 1 – 100 sec, 1 – 100 min

Dimensions (mm): W x H x D

6.2 x 89 x 70



Multifunction On delay/off delay, interval timer, flashing

Approvals: CSA

Timer on delay relay

Approvals: CSA

Time range	Screw terminal	Spring-clamp	Box Qty	Screw terminal	Spring-clamp	Box Qty
0.1 – 300 sec			10			
1 – 100 sec					81.020.4101.0	10
1 – 100 min					81.020.4102.0	10
Wiring diagram, derating curve, limit curve	See pages 474			See pages 474		
Coil circuit						
Operating voltage	24 V DC +10%/–15%			24 V DC +10%/–15%		
Control voltage	24 V DC +10%/–15%			24 V DC +10%/–15%		
Nominal current	ca. 10 mA			ca. 10 mA		
Time setting	At the front (behind the hinged identification plate holder)			At the front (behind the hinged identification plate holder)		
Setting of function	DIP switch S1–S5/potentiometer			Potentiometer		
Status display	LED Green			Green LED		
Repeat accuracy	± 1% of selected range			± 1% of selected range		
Switching characteristics						
Maximum switching voltage	250 V AC / 300 V DC			250 V AC / 300 V DC		
Maximum switching current	6 A AC / 2 A DC			6 A AC / 2 A DC		
Maximum switching capacity	1500 VA / 48 W			1500 VA / 48 W		
Maximum starting current	10 A; 4 sec.			10 A; 4 sec.		
Pickup/dropout delay	1 ms / 5 ms			1 ms / 5 ms		
Chatter time	2 ms			2 ms		
Maximum switching frequency	20 Hz			20 Hz		
Contact material	AgSnO ₂			AgSnO ₂		
Minimum switchable voltage	12 V			12 V		
Minimum switchable current	8 mA			8 mA		
Mechanical endurance	2 x 10 ⁷			2 x 10 ⁷		
Electrical endurance 24 V DC / 2 A	6 x 10 ⁵			6 x 10 ⁵		
Electrical endurance 230 V AC / 6 A	8 x 10 ⁴			8 x 10 ⁴		
Rated voltage						
Isolation voltage of input/output	4 kV _{eff.}			4 kV _{eff.}		
Overvoltage category	III (according to HD 625.1S1)			III (according to HD 625.1S1)		
Degree of pollution	2 (according to HD 625.1S1)			2 (according to HD 625.1S1)		
Ambient temperature	0 °C...+50 °C			0 °C...+50 °C		
Storage temperature	–40 °C...+80 °C			–40 °C...+80 °C		
Protection type/mounting rail	IP 20 / TS35			IP 20 / TS35		
Norms/specifications	VDE 0160; VDE 0106 T101			VDE 0160; VDE 0106 T101		
Emitted interference/interference immunity	EN 61000-6-3; EN 61000-6-2			EN 61000-6-3; EN 61000-6-2		
Wire range of screw terminals	–			–		
Wire range of spring clamp terminals						
finely stranded	0.14 mm ² – 1.5 mm ²			0.14 mm ² – 1,5 mm ²		
single core	0.5 mm ² – 2.5 mm ²			0.5 mm ² – 2.5 mm ²		
CSA EX approval in range	Class I, Division 2, Groups A, B, C and D			Class I, Division 2, Groups A, B, C and D		
Accessories						
Plug-in jumper (U _{max.} = 50 V, I _{max.} = 2 A)	Z8.000.0200.8			Z8.000.0200.8		
8 digit marker tag, unmarked, 60 off	Z4.242.5153.0			Z4.242.5153.0		
Comb for potential distribution, red/blue	Z8.000.0202.3 / Z8.000.0202.4			Z8.000.0202.3 / Z8.000.0202.4		
End caps for comb, red/blue	Z8.000.0202.1 / Z8.000.0202.2			Z8.000.0202.1 / Z8.000.0202.2		

WRS

Multifunction time relay

- on delay
- interval timer
- flashing
- off delay
- timer range 0.1 sec – 255 sec



WRS Multifunction timer relay

Approvals: CSA,

Dimensions (mm): W x H x D
38.7 x 80 x 60

Multi function	Screw terminal	Spring-clamp	Box Qty
0.10 – 255.0 sec	WRS-TIMER-250V5A	81.020.3000.0	10
Wiring diagram, derating curve, limit curve			
See pages 474			
Coil circuit			
Operating voltage	24 V DC +10%/-15%		
Nominal input current	8.2/29 mA inactive/active		
RC circuit of input	Polarised diode		
Status display	Input	LED Green	
	Output	LED red	
Time setting	Potentiometer		
Parallel connection of max	20 Relays		
Switching characteristics			
Maximum switching voltage	250 V AC / V DC ¹⁾		
Maximum switching current	6 A AC / V DC ¹⁾		
Maximum switching capacity	1500 VA / 192 W ¹⁾		
Maximum continuous current	5 A AC / DC ¹⁾		
Pickup/dropout delay approx.	10 ms / 5 ms		
Chatter time	3 ms		
Contact material	AgNi 0.15 + 0.2 µ Au		
Minimum switchable voltage	5 V		
Minimum switchable current	10 mA		
Mechanical endurance	3 x 10 ⁷		
Electrical endurance at 24 V DC / continuous current	1.5 x 10 ⁵		
Electrical endurance at 230 V AC / continuous current	1.5 x 10 ⁵		
Insulation voltage of input/output	4 kV _{eff}		
Ambient temperature	-25 °C...+50 °C		
Storage temperature	-40 °C...+85 °C		
Wire range			
finely stranded	0.5 mm ² – 2.5 mm ²		
single core	0.5 mm ² – 4 mm ²		
Mounting rail	TS 32 or TS 35		
Location of mounting rail	horizontal		
Accessories			
Plug-in jumper (I _{max} = 0.5 A AC/DC)	Z8.000.0103.4		10
¹⁾ See limit curve on page 471			

Wiring diagrams: *flare* – Mechanical relay modules

12-V-/24-V-Relay 1 Changeover contact

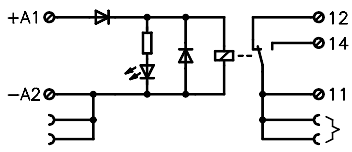

110-V-/230-V-Relay 1 Changeover contact

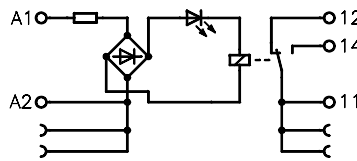

24-V-Relay 2 Changeover contact

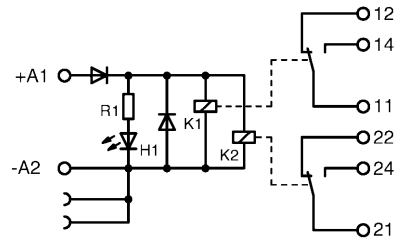

Knife-edge disconnect terminal relay

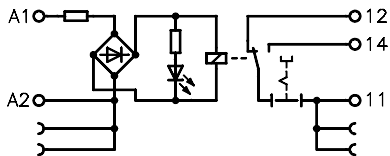

Hand-0-Auto-Relay

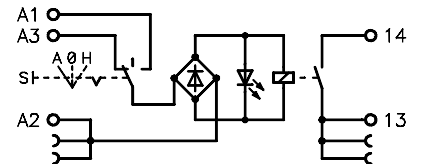

Housing with spring clamp terminals

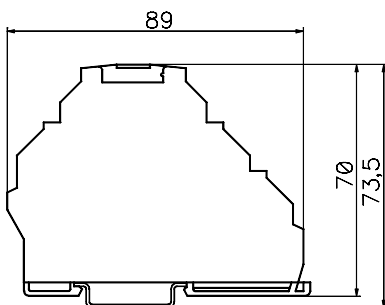

Housing with screw terminals

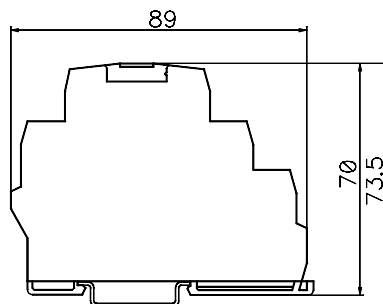

Connection of Knife-edge disconnect terminal relay

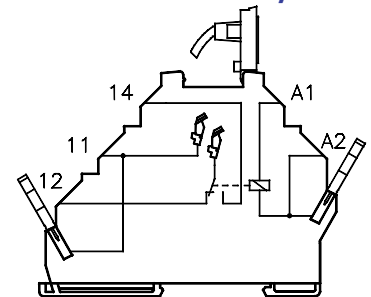

Derating: *flare* – Mechanical relay modules

24-V-Relay 1/2 Changeover contact
 12-V-Relay 1 Changeover contact
 Knife-edge disconnect terminal relay
 HAND-0-AUTO-Relay
 Time relay

110-V-Relay 1 Changeover contact

230 V-Relay 1 Changeover contact

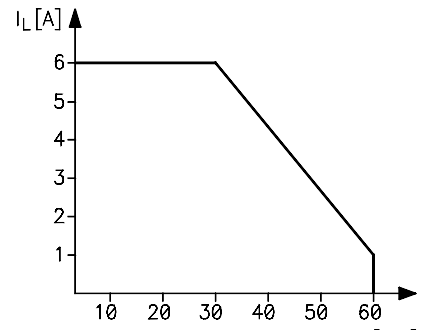
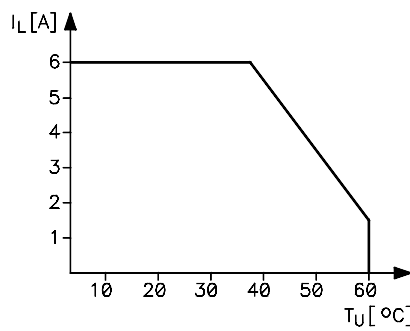
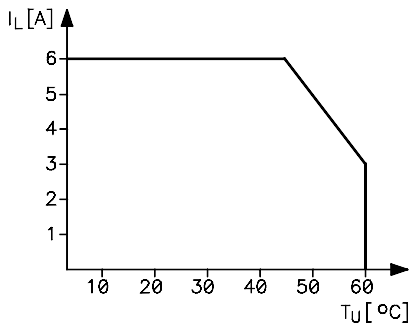

Derating curve for d.c. loads

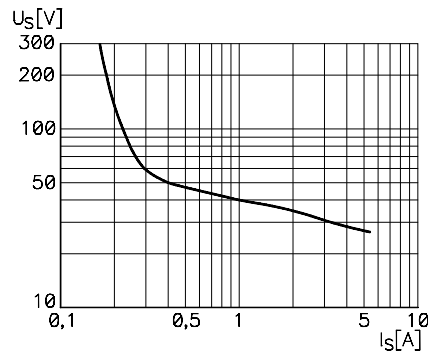

Switching capacity according to 60947-5.1

	AC 12	AC 15	DC 13
V	A	A	A
24	6	3	1
110	6	3	0.2
230	6	3	0.1

Relay modules



Wiring diagrams

Derating

WEG-REL-1S 250 V 3 A

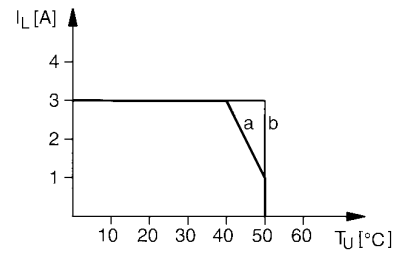
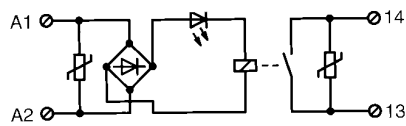

WEG-REL-1W 250 V 5 A

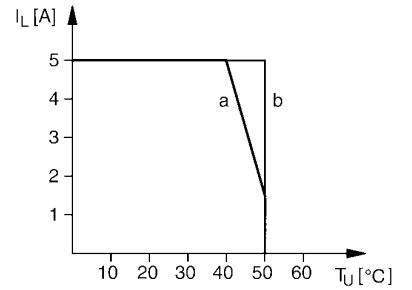
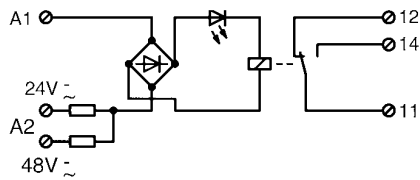

WEG-REL-2W 250 V 4 A

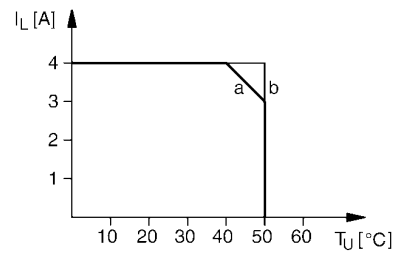
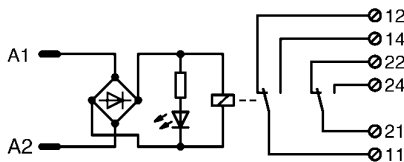

a = side by side without spacing
 b = side by side with spacing > 20 mm

Wiring diagrams

Derating

WEG-230-1S 250 V 1 A

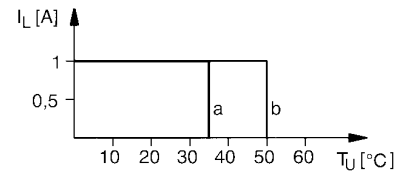
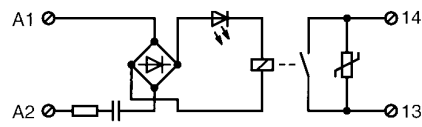

a = side by side without spacing
b = side by side with spacing > 20 mm

WEG-DUO-1W 250 V 3 A

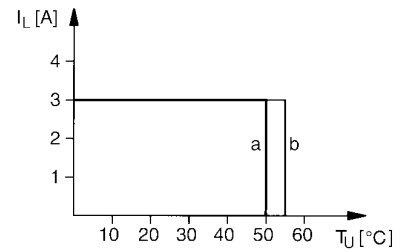
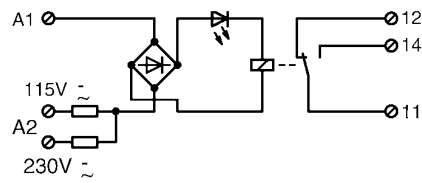

Limit curve (for resistive load)

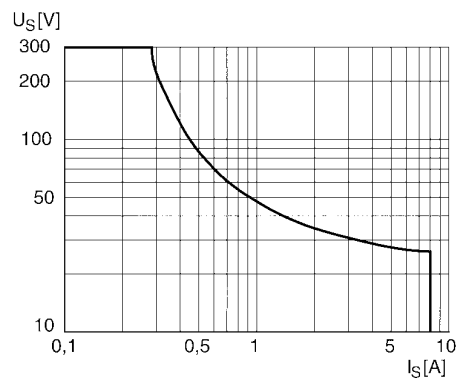

Relay modules



Dimensions

WEG-REL-1S 250 V 3 A

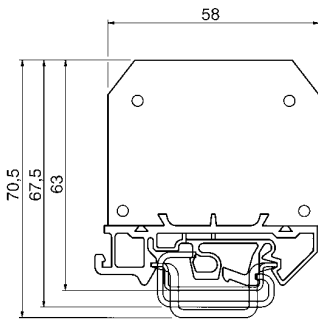

**WEG-REL-1W 250 V 5 A und
WEG-REL-2W 250 V 4 A**

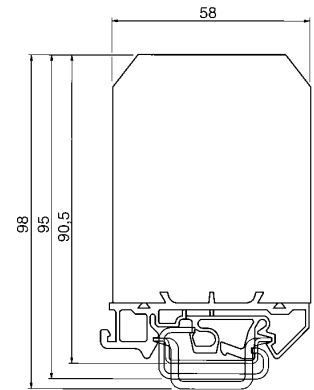

WEG-230-1S 250 V 1 A

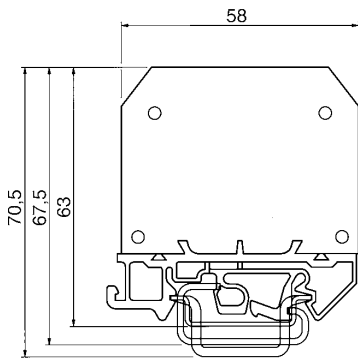

**WEG-DUO-1W 250 V 3 A
Current relay SR 4...20mA**

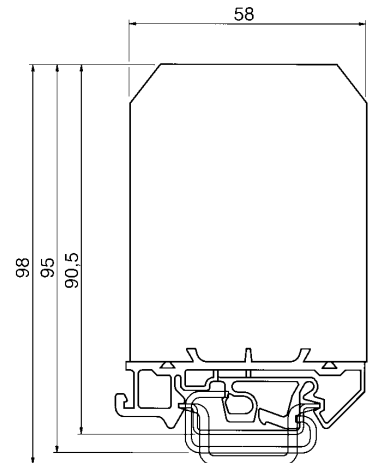

**Wiring diagram
Current relay
SR 4...20 mA**

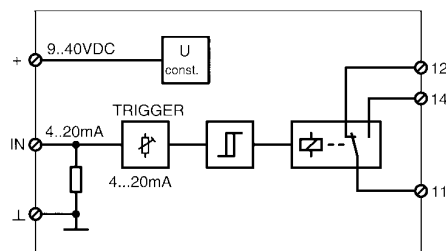

Wiring diagrams

R12-12V-1W 250 V 5 A

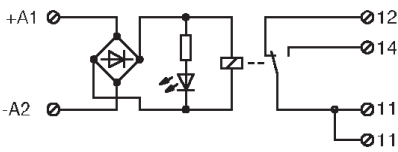

RAB – 1 Changeover contact

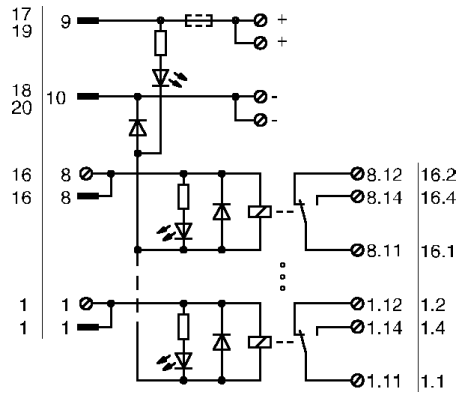

RAB – 2 Changeover contact

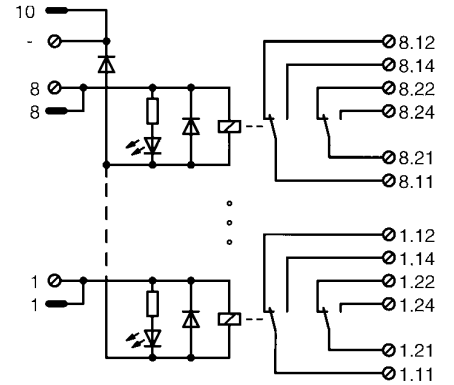

Derating

R12-12V-1W 250 V 5 A

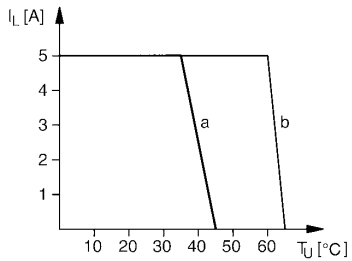

a = continuous operation
b = switching operation 50% duty cycle

RAB-FSS and RAB-SS

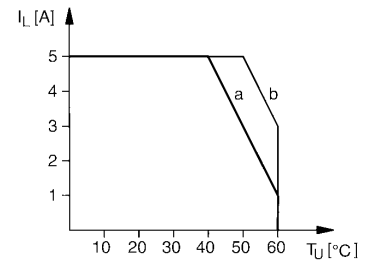

Dimensions

R12-12V-1W 250 V 5 A

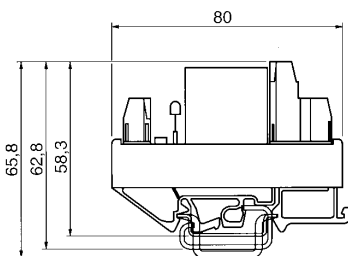

RAB – 1 Changeover contact

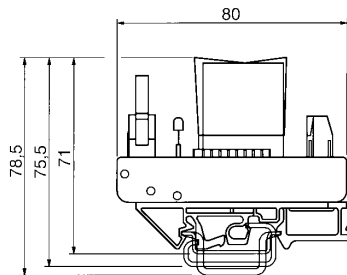

RAB – 2 Changeover contact

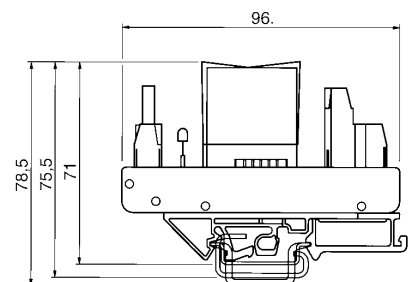

Relay modules



Wiring diagrams

WR1-230-1W 250 V 4 A

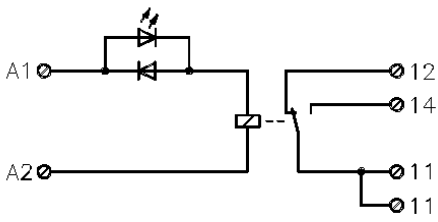

WR4/8-115-1W 250 V 4 A

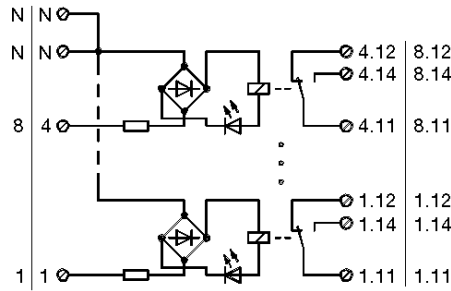

WR4/8-230-1W 250 V 4 A

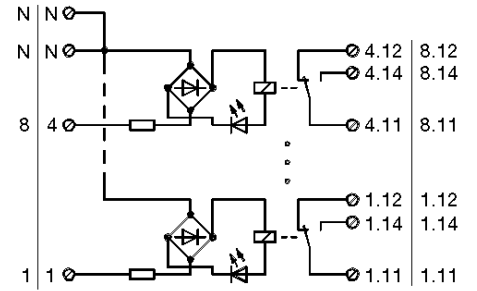

WR1-DUO-2W 250 V 5 A

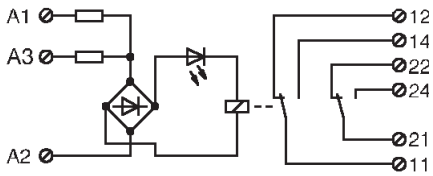

WR4/8-115-2W 250 V 4 A

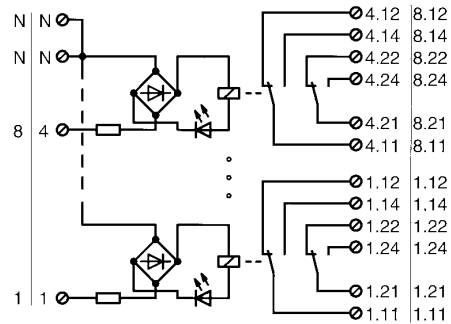

WR4/8-230-2W 250 V 4 A

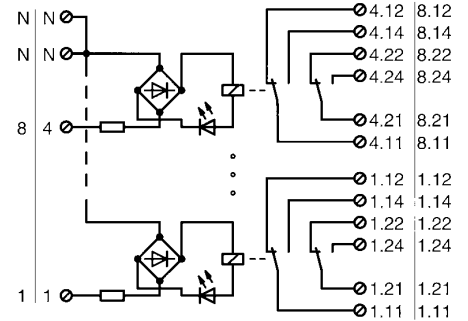

Derating

WR1 – 1 Changeover contact

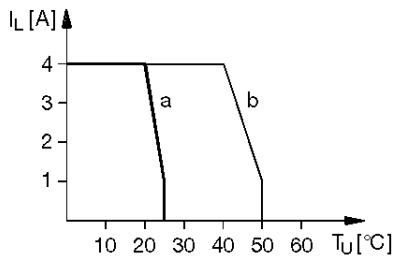

a = side by side without spacing
b = side by side with spacing of 5 mm

WR1 – DUO

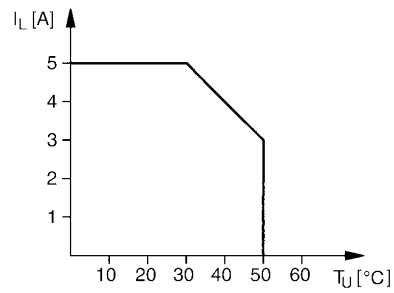

WR4/WR8 – 2 Changeover contact

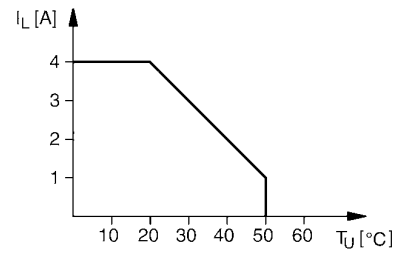

Dimensions

WR1 – 1 Changeover contact

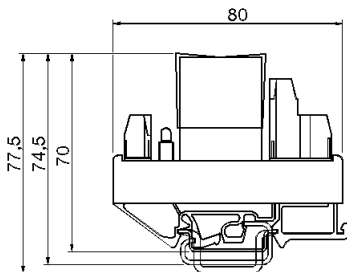

WR4/WR8 – 1 Changeover contact

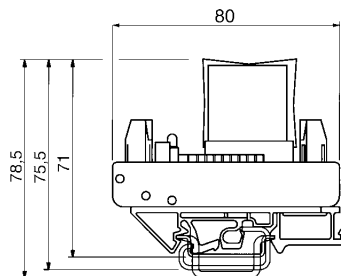

WR1 – DUO

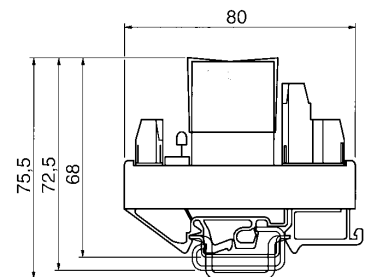

WR4/WR8 – 2 Changeover contact

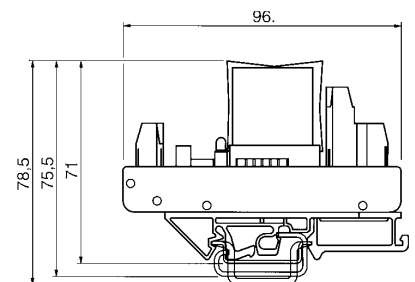

Relay modules



Wiring diagrams of relay couplers

WRS-REL-1S 250 V 5 A

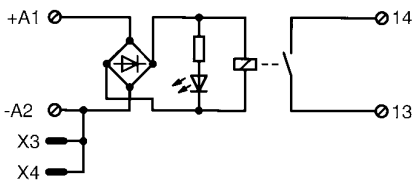

WRS-REL-1W 250 V 5 A

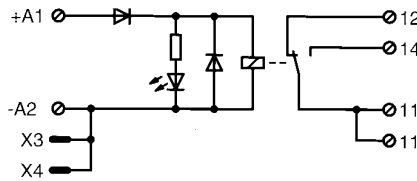

WRS-REL-2W 250 V 5 A

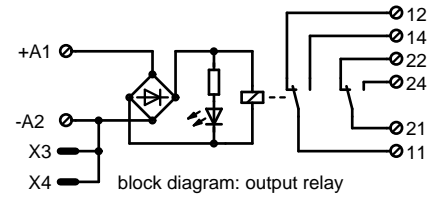

WRS-REL-1W 250 V 16 A

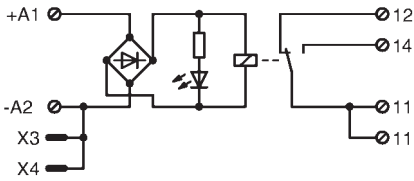

Dimensions

**WRS-REL-1S 250 V 5 A
WRS-REL-1W 250 V 16 A**

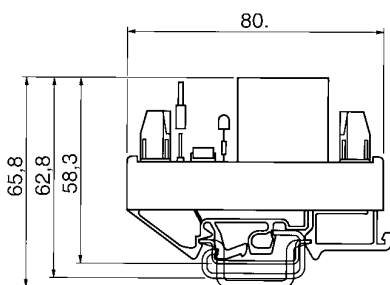

**WRS-REL-1W 250 V 5 A
WRS-REL-2W 250 V 5 A**

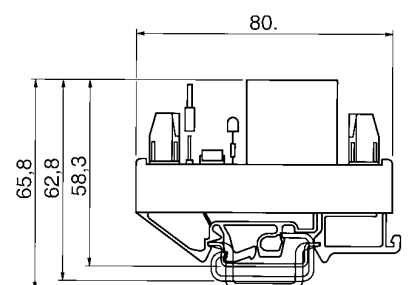

Derating

WRS-REL-1S 250 V 5 A
WRS-REL-1W 250 V 5 A

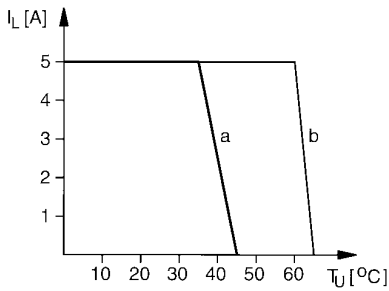

a = side by side without spacing
 b = side by side with spacing > 20 mm

Contact loading:
WRS-REL-1S 250 V 5 A
WRS-REL-1W 250 V 5 A
WRS-REL-2W 250 V 5 A

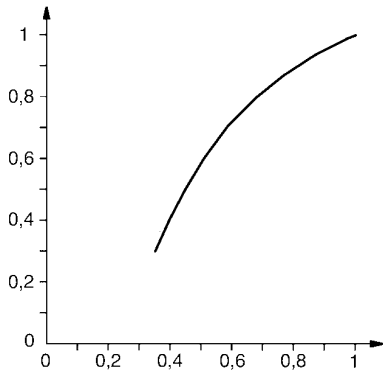

Limit curve:
WRS-REL-1S 250 V 5 A
WRS-REL-1W 250 V 5 A
WRS-REL-2W 250 V 5 A

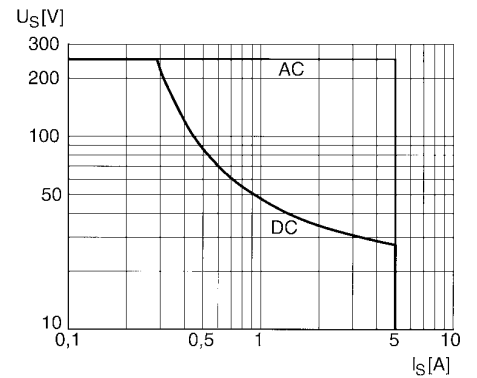

D.C. limit curve and derating curve:
WRS-REL-1W 250 V 16 A

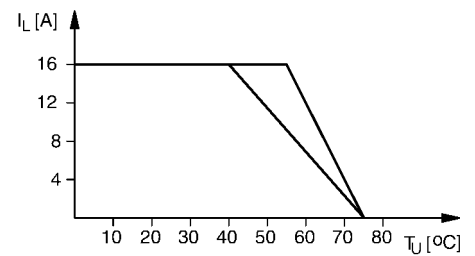
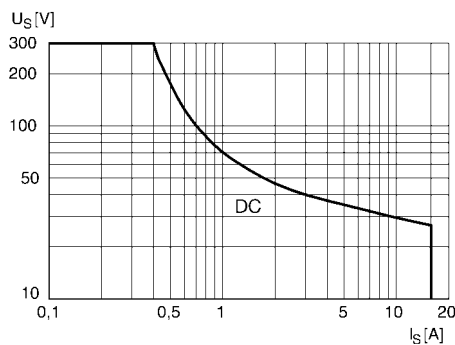

a = side by side without spacing
 b = side by side with spacing of 5 mm

Block diagrams of *flare* timer relays

Multifunction

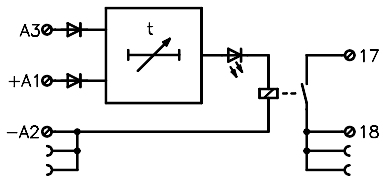

with pickup delay

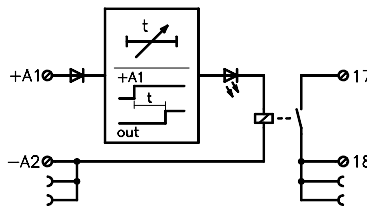

Derating: Timer relays

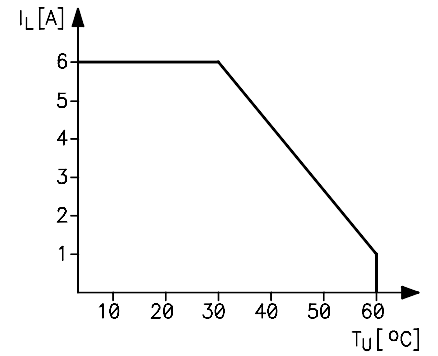

Setting the type of function

Function	DIP-Switch		
	1	2	3
on delay	on	on	on
interval timer	on	off	on
flashing pause start	on	on	off
flashing pulse start	on	off	off
off delay	off	off	off

Setting the time ranges

timer range $\pm 20\%$		DIP-Switch	
t min	t max	4	5
0.1	1.2 sec	off	on
0.4	5 sec	on	off
3.5	40 sec	on	on
30	300 sec	off	off

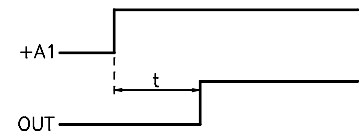

on delay

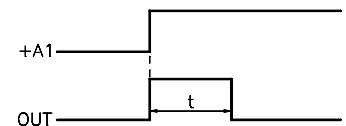

interval timer

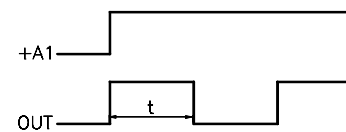

flashing pulse start

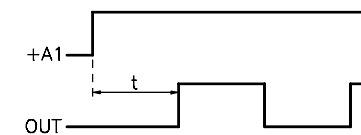

flashing pause start

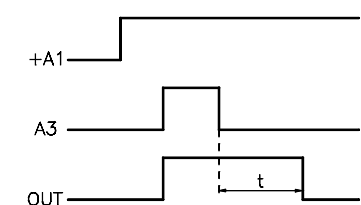

off delay

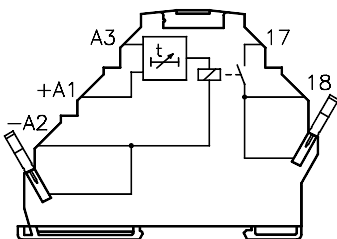

Terminal assignment: Timer relay

Block diagram of multi function WRS timer relays

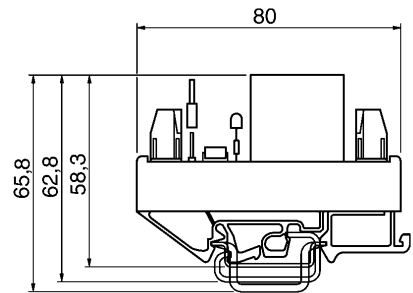
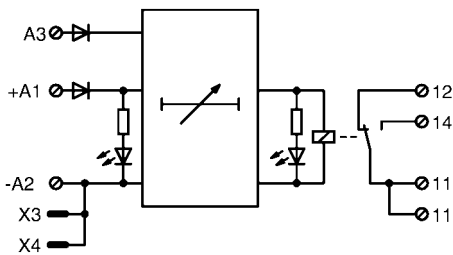

Setting the type of function

Function	DIP-switch		
	1	2	3
on delay	on	on	on
interval timer	on	off	on
flashing pulse start	on	on	off
flashing pause start	on	off	off
off delay	off	off	off

Setting the time ranges

timer range $\pm 20\%$		DIP-switch	
t min	t max	4	5
0.1	1.2 sec	off	on
0.4	5 sec	on	off
3.5	40 sec	on	on
30	300 sec	off	off

