



Ultra High Performance BGA Cooling Solutions w/ maxiGRIP™ Attachment

ATS PART # ATS-50350B-C2-R0

Features & Benefits

- » maxiFLOW™ design features a low profile, spread fin array that maximizes surface area for more effective convection (air) cooling
- » maxiGRIP™ attachment applies steady, even pressure to the component and does not require holes in the PCB
- » Meets Telcordia GR-63-Core Office Vibration; ETSI 300 019 Transportation Vibration; and MIL-STD-810 Shock and Unpackaged Drop Testing standards
- » Comes preassembled with high performance, phase changing, thermal interface material
- » Designed for standard height components from 3 to 4.5mm

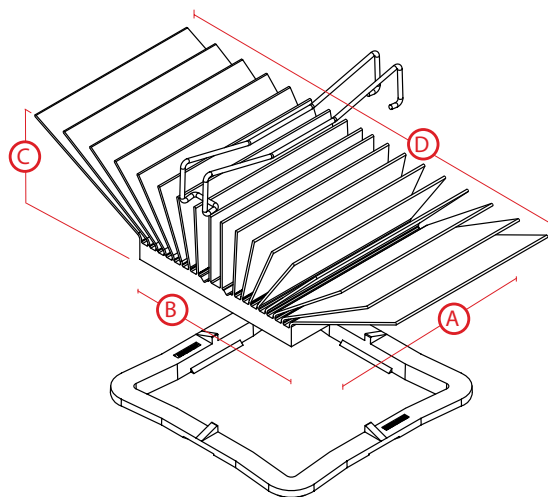

*Image above is for illustration purposes only.

Thermal Performance

AIR VELOCITY

THERMAL RESISTANCE

FT/MIN	M/S	°C/W (UNDUCTED FLOW)	°C/W (DUCTED FLOW)
200	1.0	5.3	3.4
300	1.5	3.9	
400	2.0	3.2	
500	2.5	2.9	
600	3.0	2.6	
700	3.5	2.4	
800	4.0	2.2	

Product Details

DIMENSION A	DIMENSION B	DIMENSION C	DIMENSION D	INTERFACE MATERIAL	FINISH
35 mm	35 mm	7.5 mm	44.9 mm	SAINT-GOBAIN C1100F	BLUE-ANODIZED

NOTES:

- 1) Dimension C = heat sink height from bottom of the base to the top of the fin field.
- 2) ATS-50350B-C1-R0 is a substitute item available utilizing an equivalent phase change material (Chomerics T766).
- 3) Thermal performance data are provided for reference only. Actual performance may vary by application.
- 4) ATS reserves the right to update or change its products without notice to improve the design or performance.
- 5) Optional maxiGRIP™ Installation/Removal Tool Set P/N: MGT350
- 6) Contact ATS to learn about custom options available.



ATS ADVANCED
THERMAL
SOLUTIONS, INC.
Innovations in Thermal Management®

For more information, to find a distributor or to place an order, visit www.qats.com or call: 781.769.2800 (North America); +31 (0) 3569 84715 (Europe).