



plugs
and sockets

plugs
and sockets

Global are the designers and manufacturers of temperature measurement solutions; connectors are just one of many products. If you have a special requirement for connectors, cable, sensing devices, calibration blocks or instrumentation, please phone or email our sales desk for advice, we are sure we will be able to help.



Global

Measurement and Control

Global Measurement and Control Limited

Unit 17, Ford Lane Business Park, Ford Lane, Nr Arundel, West Sussex BN18 0UZ

Telephone: 01243 555277 • Fax: 01243 555177

e-mail: enquiries@globaltd.co.uk • website: www.globaltd.co.uk

A member of the Concord Group



Global
Measurement and Control

plugs and sockets

Global are a company specialising in temperature measurement solutions, one being the manufacture of miniature and standard thermocouple connectors.

Our range of miniature and standard connectors are uniquely shaped allowing ease of use, manufactured as a one pressed body giving superior strength and quality, and are available in most common thermocouple combinations, using thermocouple grade alloys for error free connections.

Our connector range is available with maximum temperature ratings of 220°C and 560°C. The 220°C connectors are colour coded to international colour standard IEC584.3 :1989 (other colour standards available upon request). The 560°C ceramic connectors are supplied in white and are marked with identifying international colour code.

Pins are polarised by size and are marked for negative and positive polarity. All connectors are compatible with other miniature and standard connectors. To order, please use the part code shown against the product and type.

A range of accessories and fascia mounting systems are also available.

All miniature in-line connectors have a 3mm cable entry, and all standard in-line connectors have a 6mm cable entry.

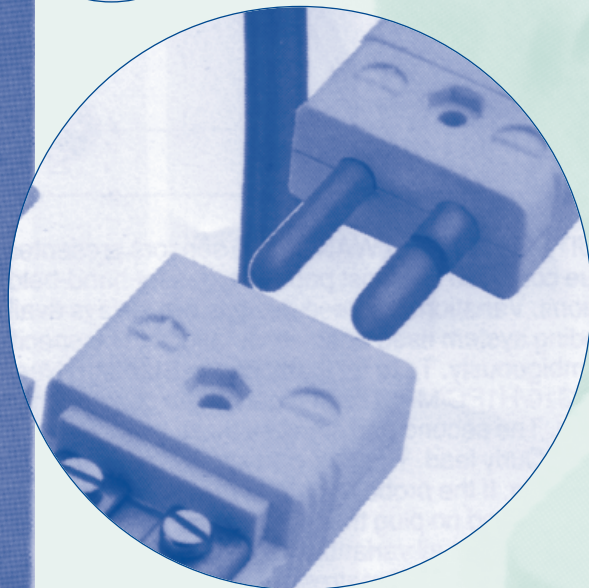
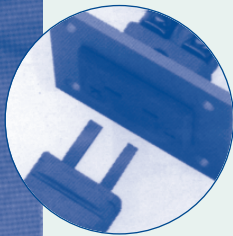

Miniature connectors

Mini Plug - In line. Rated 220°C

PART NO.	TYPE
04-3510-00	J
04-1510-00	K
04-6510-00	N
04-2510-00	T
04-8510-00	Copper

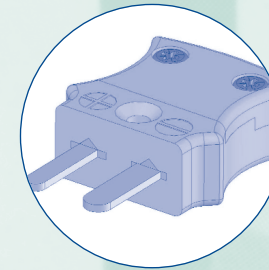

Ceramic Mini Plug - In line. Rated 560°C

PART NO.	TYPE
04-3710-00	J
04-1710-00	K
04-6710-00	N
04-2710-00	T
04-8710-00	Copper

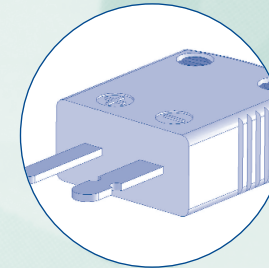

Mini Socket - In line. Rated 220°C

PART NO.	TYPE
04-3560-00	J
04-1560-00	K
04-6560-00	N
04-2560-00	T
04-8560-00	Copper

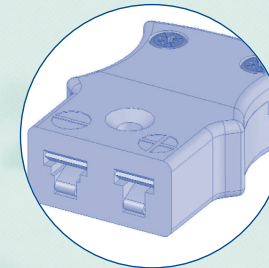

Ceramic Mini Socket - In line. Rated 560°C

PART NO.	TYPE
04-3760-00	J
04-1760-00	K
04-6760-00	N
04-2760-00	T
04-8760-00	Copper

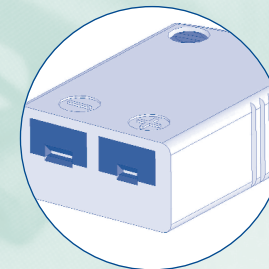

Mini Fascia Socket - Rated 220°C

PART NO.	TYPE
04-3560-01	J
04-1560-01	K
04-6560-01	N
04-2560-01	T
04-8560-01	Copper

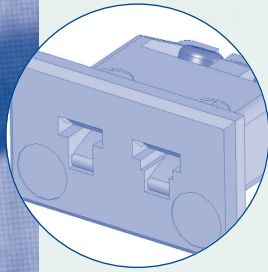

Mini Socket Panel- With S/S Bracket. Rated 220°C

PART NO.	TYPE
04-3560-06	J
04-1560-06	K
04-6560-06	N
04-2560-06	T
04-8560-06	Copper

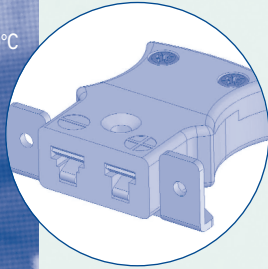

Mini Quickwire Socket - Rated 220°C

PART NO.	TYPE
04-3560-04	J
04-1560-04	K
04-6560-04	N
04-2560-04	T
04-8560-04	Copper

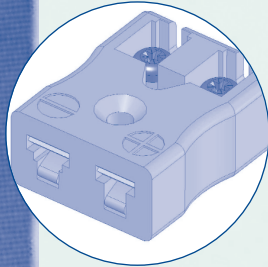

Mini PCB Socket - Rated 220°C

PART NO.	TYPE
04-3760-02	J
04-1760-02	K
04-6760-02	N
04-2760-02	T
04-8760-02	Copper

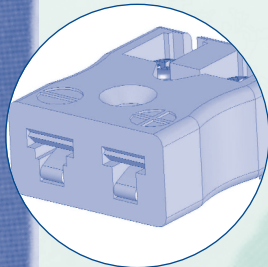

Cable Caddie - Mini plug with wire carrier

PART NO.	TYPE
??-??-??	?

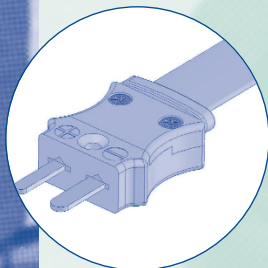

Standard connectors

Using solid pin construction.

Standard Plug - In line. Rated 220°C

PART NO.	TYPE
04-3010-00	J
04-1010-00	K
04-6010-00	N
04-2010-00	T
04-8010-00	Copper

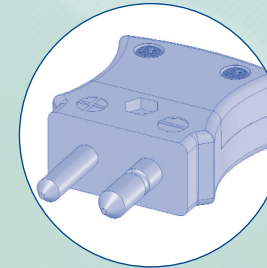

Standard Socket - In line. Rated 220°C

PART NO.	TYPE
04-3060-00	J
04-1060-00	K
04-6060-00	N
04-2060-00	T
04-8060-00	Copper

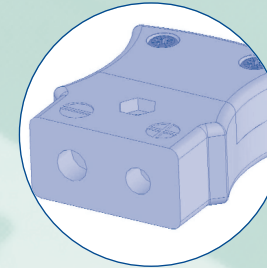

Standard Fascia - Rated 220°C

PART NO.	TYPE
04-3060-01	J
04-1060-01	K
04-6060-01	N
04-2060-01	T
04-8060-01	Copper

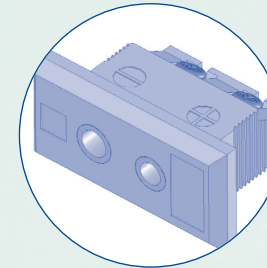

Ceramic Standard Plug - In line. Rated 560°C

PART NO.	TYPE
04-3310-00	J
04-1310-00	K
04-6310-00	N
04-2310-00	T
04-8310-00	Copper

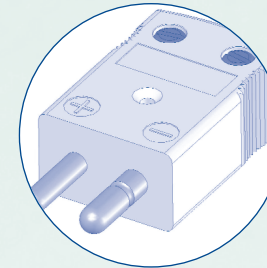

Other thermocouple calibrations are available on request

Ceramic Standard Socket - In line. Rated 560°C

PART NO.	TYPE
04-3360-00	J
04-1360-00	K
04-6360-00	N
04-2360-00	T
04-8360-00	Copper

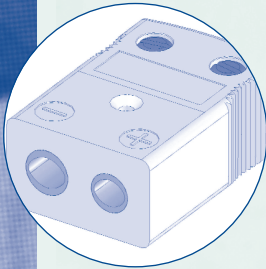

Standard Socket - With S/S Bracket. Rated 220°C

PART NO.	TYPE
04-3060-00	J
04-1060-00	K
04-6060-00	N
04-2060-00	T
04-8060-00	Copper

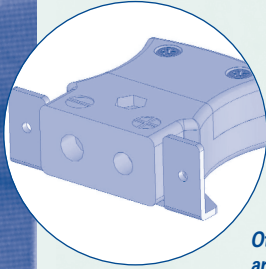

Other thermocouple calibrations are available on request

Accessories

for miniature connectors

Cable Clamp - Miniature and Standard

PART NO.	TYPE
??-????-??	Miniature
??-????-??	Standard

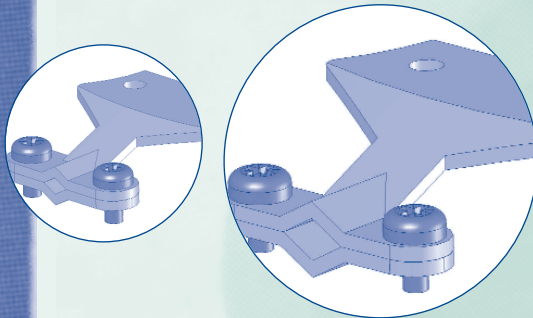

Neoprene Grommet - Miniature and Standard

PART NO.	TYPE
??-????-??	Miniature
??-????-??	Standard

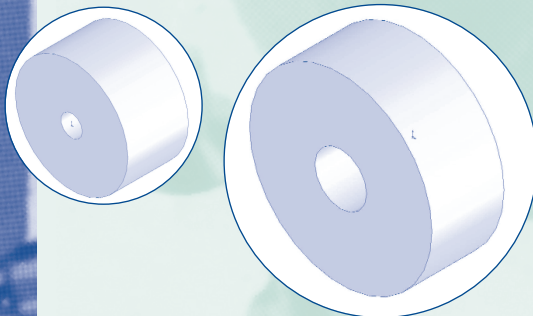

Standard Crimp Inserts - Standard inserts can be drilled out to the following sizes

PART NO.	SIZE
??-????-??	0.5mm, 1.0mm or 1.5mm
??-????-??	1.5mm, 3.0mm or 4.5mm

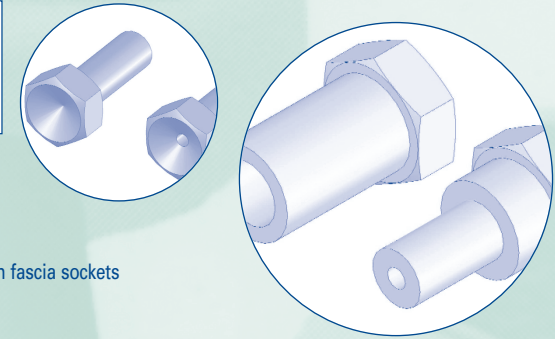

Standard and Mini Panels - Aluminium panel for use with fascia sockets

Mini Panel

PART NO.	WAYS	SIZE
??-????-??	2 Way	L-40mm
??-????-??	4 Way	L-72mm
??-????-??	6 Way	L-104mm
??-????-??	8 Way	L-136mm
??-????-??	10 Way	L-168mm
??-????-??	12 Way	L-200mm

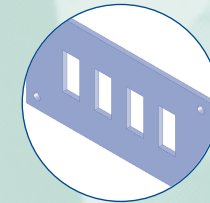

Standard Panel

PART NO.	WAYS	SIZE
??-????-??	2 Way	L-62mm
??-????-??	4 Way	L-112mm
??-????-??	6 Way	L-162mm
??-????-??	8 Way	L-212mm
??-????-??	10 Way	L-262mm
??-????-??	12 Way	L-312mm

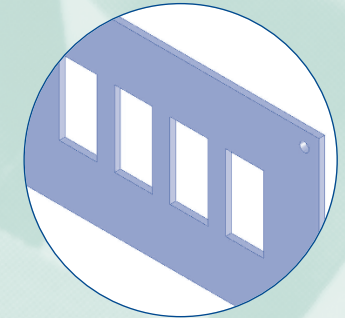

Panels - Miniature and Standard

PART NO.	TYPE
??-????-??	Miniature
??-????-??	Standard

