

MINIATURE, 1W, 3kV ISOLATED UNREGULATED DC/DC CONVERTERS

FEATURES

- Up To 78% Efficiency
- 3kVDC Isolation
- UL60950 Certified Product
- Industry Standard Footprint
- JEDEC SIP-7 Package

APPLICATIONS

- Point-of-Use Power Conversion
- Ground Loop Elimination
- Data Acquisition
- Industrial Control and Instrumentation
- Test Equipment

DESCRIPTION

The DCH01 series is a family of miniature, 1W, 3kV isolated DC/DC converters. Featured in an industry standard SIP-7 footprint, the DCH01 series requires minimal external components, reducing board space. The DCH01 series provides both single and dual split-supply outputs.

The use of a highly integrated package design results in highly reliable products with high power densities. High performance and small size makes the DCH01 suitable for a wide range of applications including signal chain applications and ground loop elimination.

Single Output Block Diagram

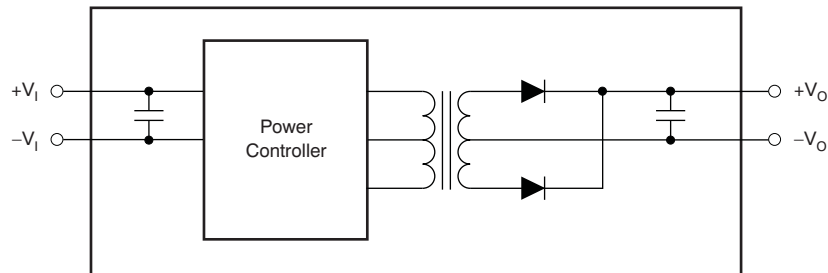

Dual Output Block Diagram

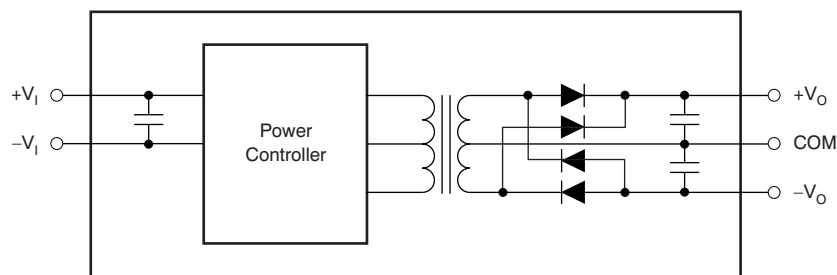

Please be aware that an important notice concerning availability, standard warranty, and use in critical applications of Texas Instruments semiconductor products and disclaimers thereto appears at the end of this data sheet.

All trademarks are the property of their respective owners.



This integrated circuit can be damaged by ESD. Texas Instruments recommends that all integrated circuits be handled with appropriate precautions. Failure to observe proper handling and installation procedures can cause damage.

ESD damage can range from subtle performance degradation to complete device failure. Precision integrated circuits may be more susceptible to damage because very small parametric changes could cause the device not to meet its published specifications.

ORDERING INFORMATION

For the most current package and ordering information, see the Package Option Addendum at the end of this data sheet, or see the TI website at www.ti.com.

Part Numbering Scheme

PRODUCT LINE	POWER	INPUT VOLTAGE	OUTPUT VOLTAGE	SINGLE/DUAL	PACKAGE	PIN CONFIG	TRANSPORT MEDIA
DCH	01	05	05	S	N	7	
H = 3kV, unregulated output	01 = 1W	05 = 5V	05 = 5V 12 = 12V 15 = 15V	S = Single D = Dual	N = SIP Thru-hole	7 = SIP-7	Blank = Tray T = Tape & Reel

DCH01 Products

MODEL	INPUT VOLTAGE (V)	OUTPUT VOLTAGE (V)	OUTPUT CURRENT (mA)	OUTPUT POWER (W)	ISOLATION VOLTAGE (kVDC)	PACKAGE-LEAD
DCH010505S	5 ± 10%	5	200	1	3	SIP-7
DCH010512S	5 ± 10%	12	83	1	3	SIP-7
DCH010515S	5 ± 10%	15	67	1	3	SIP-7
DCH010505D	5 ± 10%	±5	±100	1	3	SIP-7
DCH010512D	5 ± 10%	±12	±42	1	3	SIP-7
DCH010515D	5 ± 10%	±15	±33	1	3	SIP-7

ABSOLUTE MAXIMUM RATINGS

over operating free-air temperature range (unless otherwise noted) ⁽¹⁾

		DCH01 SERIES	UNIT
Input Voltage	5V input models	7	V
Wave soldering temperature	Surface temperature of module body or pins for 5 seconds maximum	260	°C
Storage temperature range		-40 to +125	°C

(1) Stresses beyond those listed under *Absolute Maximum Ratings* may cause permanent damage to the device. These are stress ratings only, and functional operation of the device at these or any other conditions beyond those indicated is not implied. Exposure to absolute maximum rated conditions for extended periods may affect device reliability.

ELECTRICAL CHARACTERISTICS

 At $T_A = +25^\circ\text{C}$, $V_I = 5\text{V}$ unless otherwise noted.

PARAMETER	TEST CONDITIONS	MIN	TYP	MAX	UNIT
OUTPUT					
Power	100% full load			1 ⁽¹⁾	W
	Over current duration ⁽¹⁾			1	sec
INPUT					
Voltage range on V_I		-10		10	%
ISOLATION					
Voltage	60s test, UL60950 ⁽²⁾	3			kVDC
	100% tested for 1s	3.5			kVDC
LINE					
Regulation	1% change in V_I		1		%
SWITCHING					
Switching frequency (f_{sw})			70		kHz
RELIABILITY					
Calculated	Per Telcordia SR-332; 50% stress; $T_A = +40\text{C}$	Single Output	18		FITS
		Dual Output	22		
TEMPERATURE RANGE					
Operating		-40		+85	$^\circ\text{C}$

(1) This converter does not have continuous over-current protection.

(2) During UL60950 recognition tests only.

ELECTRICAL CHARACTERISTICS PER DEVICE

 At $T_A = +25^\circ\text{C}$, $V_I = 5\text{V}$ unless otherwise noted.

PRODUCT	INPUT VOLTAGE (V)	OUTPUT VOLTAGE (V)	LOAD REGULATION (%)	OUTPUT RIPPLE ⁽¹⁾ (mV _{PP})	NO LOAD INPUT CURRENT (mA)	EFFICIENCY (%)	BARRIER CAPACITANCE (pF)
	V_I	V_{NOM}			I_q		C_{iso}
	NOMINAL	100% LOAD ⁽²⁾	10% TO 100% LOAD ⁽³⁾	100% LOAD ⁽²⁾	0% LOAD	100% LOAD ⁽²⁾	
	TYP	TYP	TYP	TYP	TYP	TYP	TYP
DCH010505S	5	5.1	10	35	60	72	3
DCH010505D	5	±5.2	9	20	60	72	3
DCH010512S	5	12.4	6	18	65	74	4
DCH010512D	5	±12.5	5	19	65	75	4
DCH010515S	5	15.2	6	31	65	75	3
DCH010515D	5	±15.3	5	22	65	76	3

(1) 20MHz bandwidth.

 (2) 100% load current = $1\text{W}/V_{NOM}$ typ.

 (3) Load Regulation = $(V_O \text{ at } 10\% \text{ load} - V_O \text{ at } 100\% \text{ load}) / V_O \text{ at } 100\% \text{ load}$.

DEVICE INFORMATION

EDJ PACKAGE
SIP-7 (Single)
(Top View)

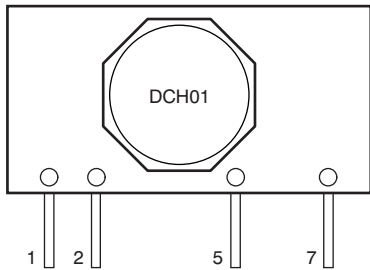

Pin Description (Single)

TERMINAL		DESCRIPTION
NAME	NO.	
+V _I	1	Voltage input
-V _I	2	Input side common
-V _O	5	-Voltage out
+V _O	7	+Voltage out

EDJ PACKAGE
SIP-7 (Dual)
(Top View)

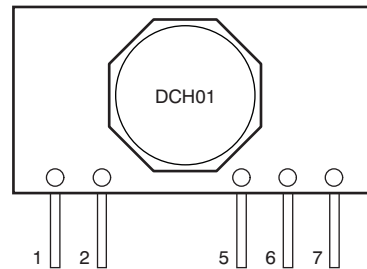

Pin Descriptions (Dual)

TERMINAL		DESCRIPTION
NAME	NO.	
+V _I	1	Voltage input
-V _I	2	Input side common
-V _O	5	-Voltage out
COM	6	Output side common
+V _O	7	+Voltage out

TYPICAL CHARACTERISTICS

At $T_A = +25^\circ\text{C}$, and $V_{IN} = 5\text{V}$ unless otherwise noted.

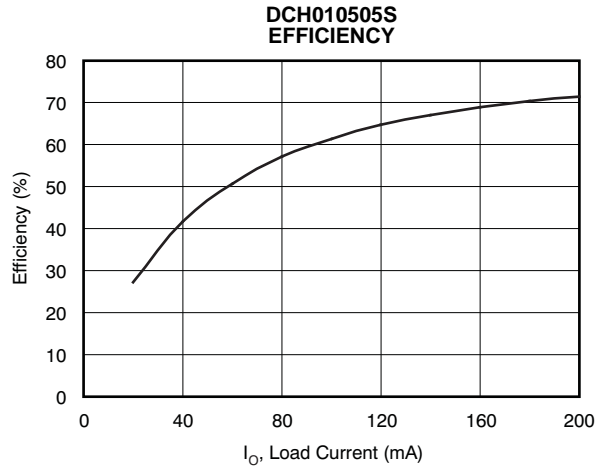

Figure 1.

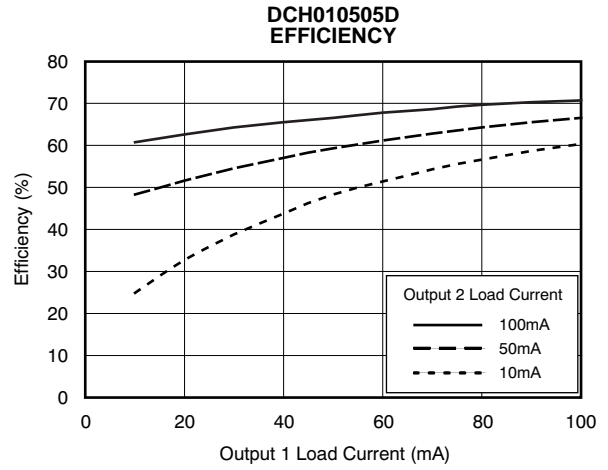

Figure 2.

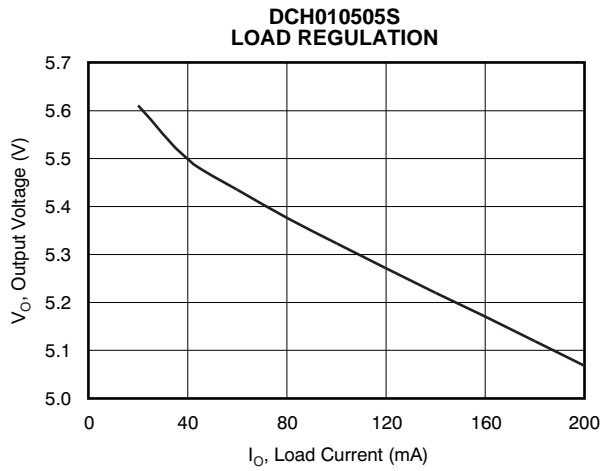

Figure 3.

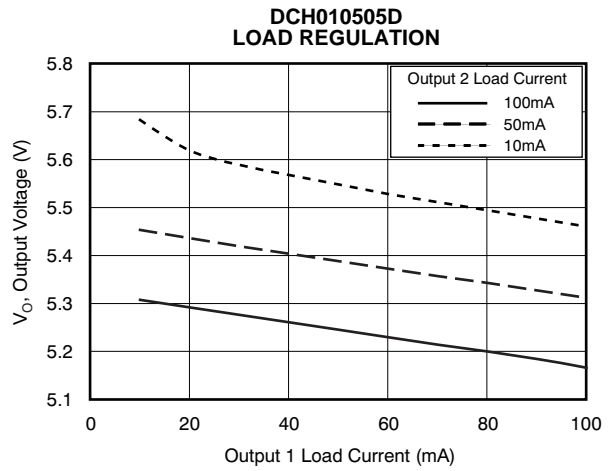

Figure 4.

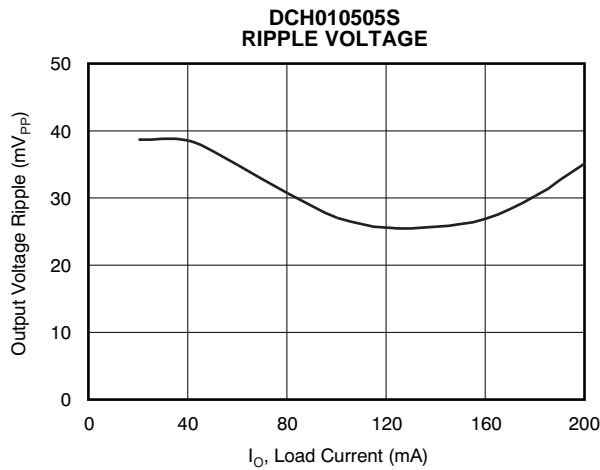

Figure 5.

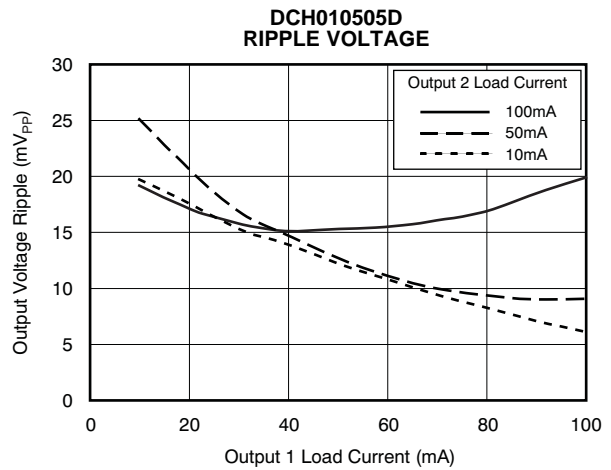

Figure 6.

TYPICAL CHARACTERISTICS (continued)

At $T_A = +25^\circ\text{C}$, and $V_{IN} = 5\text{V}$ unless otherwise noted.

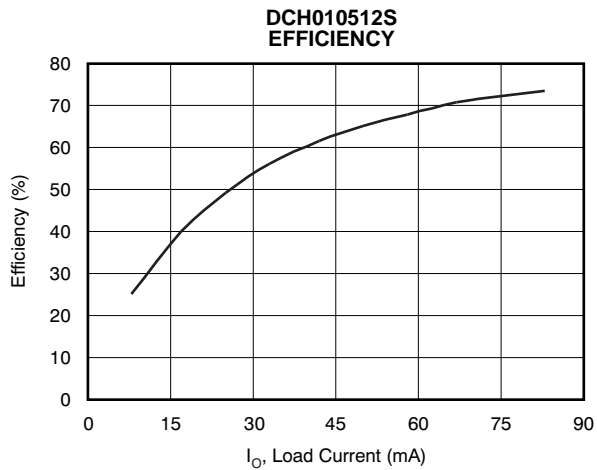

Figure 7.

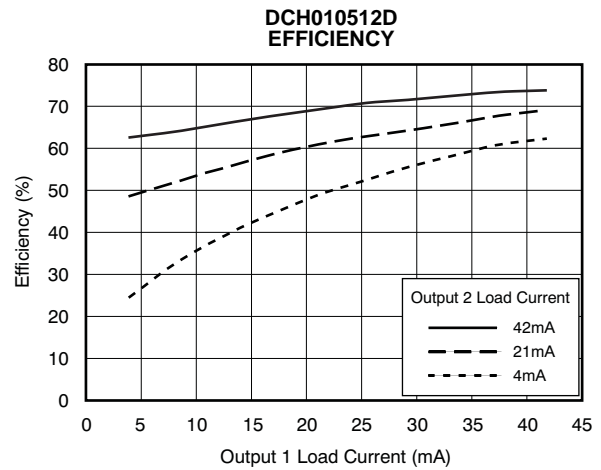

Figure 8.

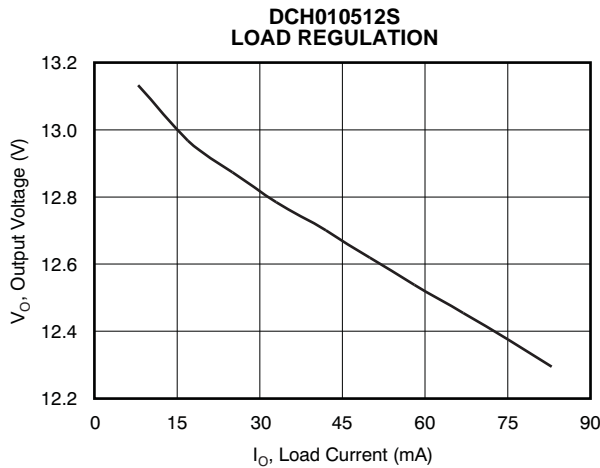

Figure 9.

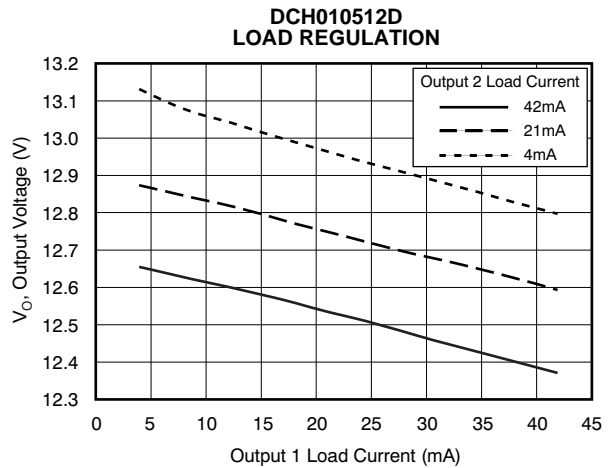

Figure 10.

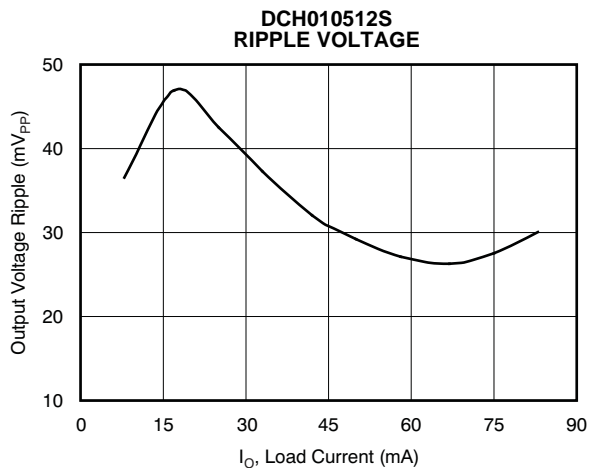

Figure 11.

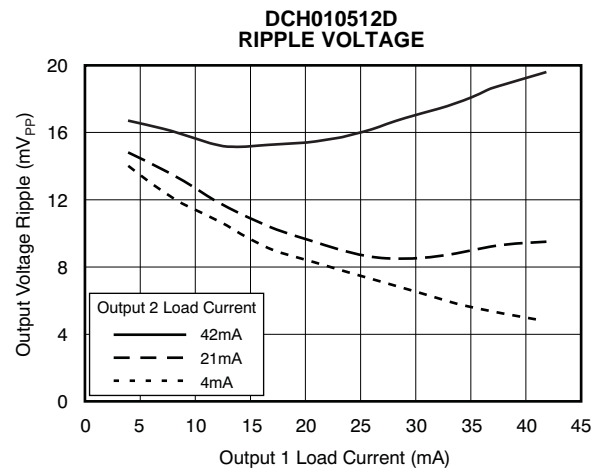

Figure 12.

TYPICAL CHARACTERISTICS (continued)

At $T_A = +25^\circ\text{C}$, and $V_{IN} = 5\text{V}$ unless otherwise noted.

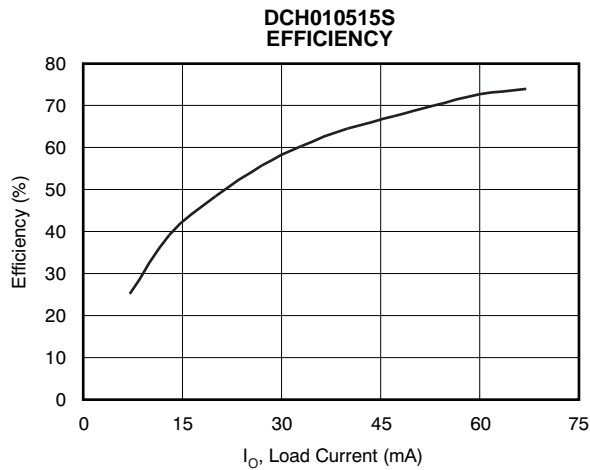

Figure 13.

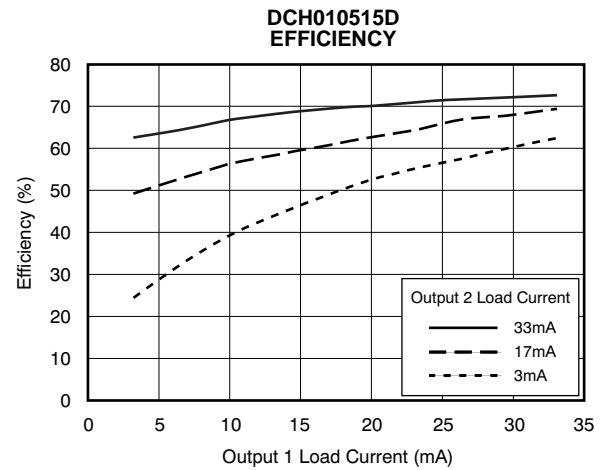

Figure 14.

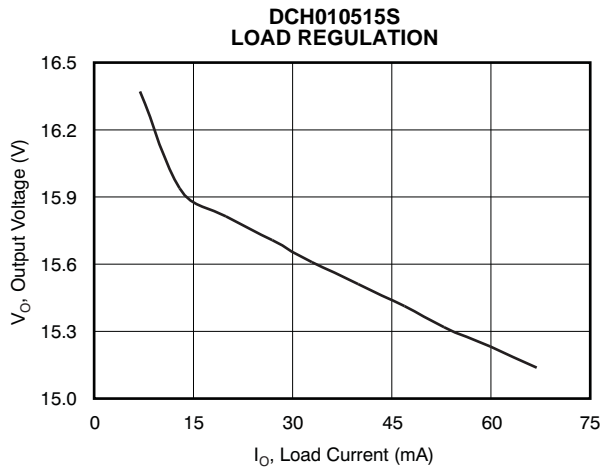

Figure 15.

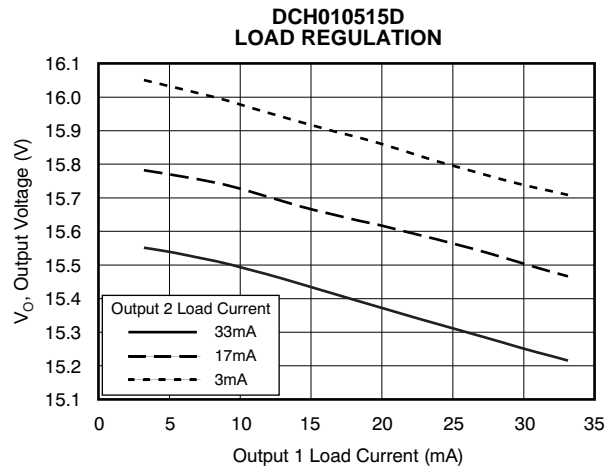

Figure 16.

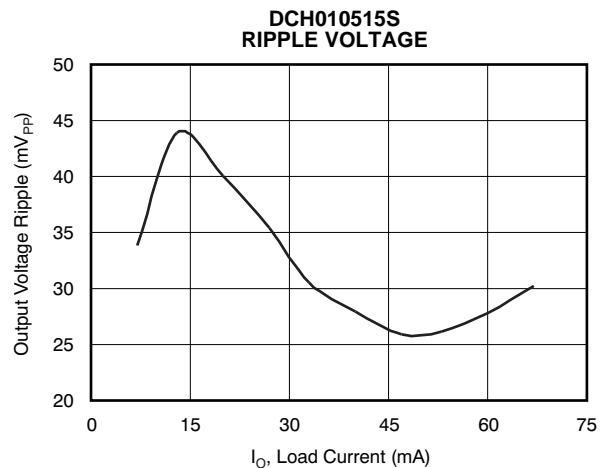

Figure 17.

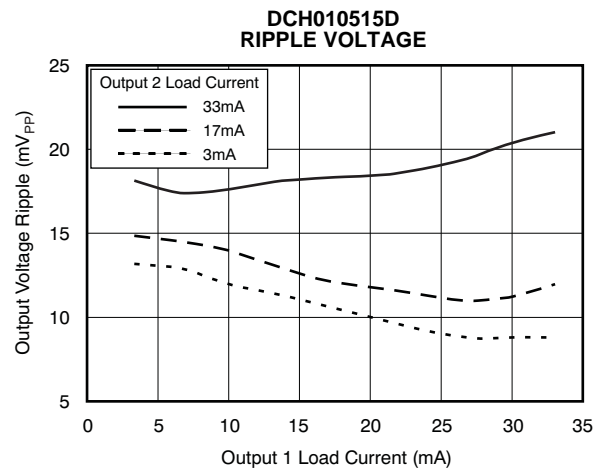

Figure 18.

TYPICAL CHARACTERISTICS (continued)

At $T_A = +25^\circ\text{C}$, and $V_{IN} = 5\text{V}$ unless otherwise noted.

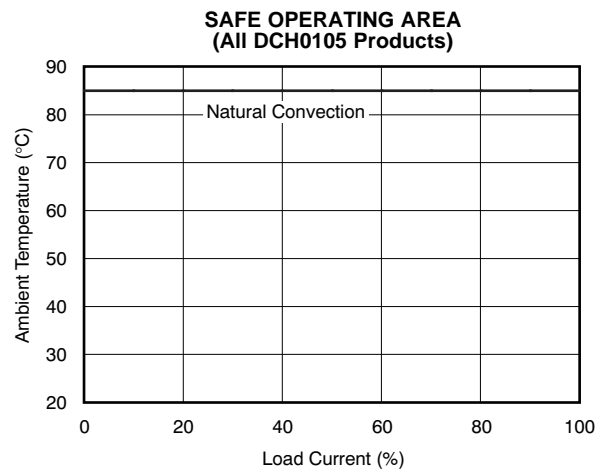

Figure 19.

FUNCTIONAL DESCRIPTION

ISOLATION VOLTAGE

The DCH01 series of DC/DC converters are 100% production tested at 3.5kVDC for 1 second. The isolation test voltage represents an operational isolation to transient voltages and should not be relied upon for safety isolation.

The continuous voltage that can be applied across the DCH01 during normal operation must be < 60VDC, within SELV limits.

Repeated High-Voltage Isolation Testing

Repeated high-voltage isolation testing can degrade the isolation capability of the DCH01.

APPLICATION INFORMATION

OPTIONAL INPUT/OUTPUT FILTERS

DCH01 power modules include internal input and output ceramic capacitors in all their designs. However, some applications require much lower levels of either input reflected or output ripple/noise. This application note describes various filters and design techniques found to be successful in reducing both input and output ripple/noise.

INPUT/OUTPUT CAPACITORS

The easiest way to reduce output ripple and noise is to add one or more 1 μ F ceramic capacitors, such as C4 shown in xxx. Ceramic capacitors should be placed close to the output power terminals. A single 1 μ F capacitor reduces the output ripple/noise by 10% to 30%.

Switching regulators draw current from the input line in pulses at their operating frequency. The amount of reflected (input) ripple/noise generated is directly proportional to the equivalent source impedance of the power source including the impedance of any input lines. The addition of a 1 μ F ceramic capacitor, near the input power pins, reduces reflected conducted ripple/noise by 30% to 50%.

The maximum capacitive load on the output of the DCH01 is 330 μ F.

π FILTERS

If a further reduction in ripple/noise level is required for an application, higher order filters must be used. A π (pi) filter, employing a ferrite bead inductor in series with the input or output terminals of the regulator reduces the ripple/noise by at least 20 db (see xxx). In order for the inductor to be effective in reduction of ripple and noise ceramic capacitors are required.

These inductors plus ceramic capacitors form an excellent filter because of the rejection at the switching frequency (650 kHz - 1 MHz). The placement of this filter is critical. It must be located as close as possible to the input or output pins to be effective. The ferrite bead is small (12,5 mm x 3 mm), easy to use, low cost, and has low dc resistance. Fair-Rite manufactures a surface-mount bead (part number 2773021447) or through hole (part number 2673000701) rated to 5 A. Inductors in the range of 1 μ H to 5 μ H can be used in place of the ferrite bead inductor.

DCH01 START-UP

Start-up waveforms

CONNECTING THE DCH01 IN PARALLEL

It is possible to connect the outputs of multiple DCH01s in series to provide non-standard voltage rails. The outputs of dual output DCH01 versions can also be connected in series to provide 2 x the magnitude of V_O , as shown in Figure 20. For example, a dual 5V DCH01 could be connected to provide a 10V rail.

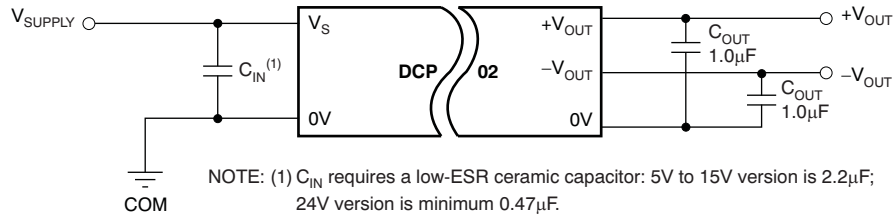

Figure 20. Connecting Dual Outputs in Series

CONNECTING THE DCH01 IN PARALLEL

If the output power from one DCH01 is not sufficient, it is possible to parallel the outputs of multiple DCH01s, as shown in Figure 21.

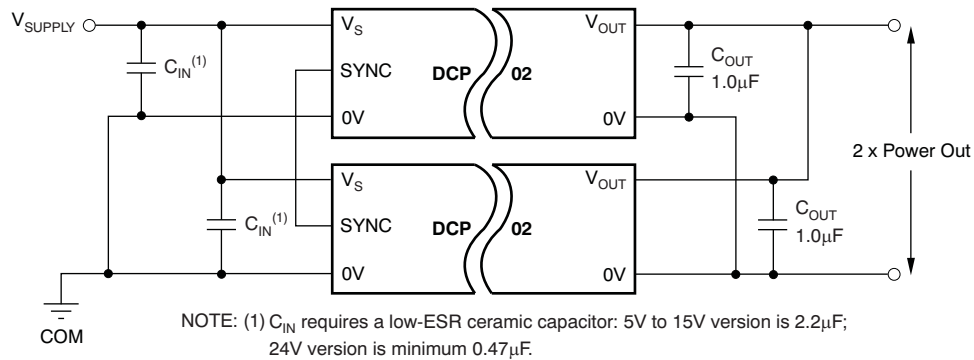

Figure 21. Connecting Multiple DCH01s in Parallel

PACKAGING INFORMATION

Orderable Device	Status ⁽¹⁾	Package Type	Package Drawing	Pins	Package Qty	Eco Plan ⁽²⁾	Lead/Ball Finish	MSL Peak Temp ⁽³⁾
DCH010505DN7	ACTIVE	SIP MOD ULE	EDJ	5	70	Pb-Free (RoHS)	Call TI	N / A for Pkg Type
DCH010505SN7	ACTIVE	SIP MOD ULE	EDJ	4	70	Pb-Free (RoHS)	Call TI	N / A for Pkg Type
DCH010512DN7	ACTIVE	SIP MOD ULE	EDJ	5	70	Pb-Free (RoHS)	Call TI	N / A for Pkg Type
DCH010512SN7	ACTIVE	SIP MOD ULE	EDJ	4	70	Pb-Free (RoHS)	Call TI	N / A for Pkg Type
DCH010515DN7	ACTIVE	SIP MOD ULE	EDJ	5	70	Pb-Free (RoHS)	Call TI	N / A for Pkg Type
DCH010515SN7	ACTIVE	SIP MOD ULE	EDJ	4	70	Pb-Free (RoHS)	Call TI	N / A for Pkg Type

⁽¹⁾ The marketing status values are defined as follows:

ACTIVE: Product device recommended for new designs.

LIFEBUY: TI has announced that the device will be discontinued, and a lifetime-buy period is in effect.

NRND: Not recommended for new designs. Device is in production to support existing customers, but TI does not recommend using this part in a new design.

PREVIEW: Device has been announced but is not in production. Samples may or may not be available.

OBSELETE: TI has discontinued the production of the device.

⁽²⁾ Eco Plan - The planned eco-friendly classification: Pb-Free (RoHS), Pb-Free (RoHS Exempt), or Green (RoHS & no Sb/Br) - please check <http://www.ti.com/productcontent> for the latest availability information and additional product content details.

TBD: The Pb-Free/Green conversion plan has not been defined.

Pb-Free (RoHS): TI's terms "Lead-Free" or "Pb-Free" mean semiconductor products that are compatible with the current RoHS requirements for all 6 substances, including the requirement that lead not exceed 0.1% by weight in homogeneous materials. Where designed to be soldered at high temperatures, TI Pb-Free products are suitable for use in specified lead-free processes.

Pb-Free (RoHS Exempt): This component has a RoHS exemption for either 1) lead-based flip-chip solder bumps used between the die and package, or 2) lead-based die adhesive used between the die and leadframe. The component is otherwise considered Pb-Free (RoHS compatible) as defined above.

Green (RoHS & no Sb/Br): TI defines "Green" to mean Pb-Free (RoHS compatible), and free of Bromine (Br) and Antimony (Sb) based flame retardants (Br or Sb do not exceed 0.1% by weight in homogeneous material)

⁽³⁾ MSL, Peak Temp. -- The Moisture Sensitivity Level rating according to the JEDEC industry standard classifications, and peak solder temperature.

Important Information and Disclaimer:The information provided on this page represents TI's knowledge and belief as of the date that it is provided. TI bases its knowledge and belief on information provided by third parties, and makes no representation or warranty as to the accuracy of such information. Efforts are underway to better integrate information from third parties. TI has taken and continues to take reasonable steps to provide representative and accurate information but may not have conducted destructive testing or chemical analysis on incoming materials and chemicals. TI and TI suppliers consider certain information to be proprietary, and thus CAS numbers and other limited information may not be available for release.

In no event shall TI's liability arising out of such information exceed the total purchase price of the TI part(s) at issue in this document sold by TI to Customer on an annual basis.

EDJ (R-PDSS-T4)

DOUBLE SIDED MODULE

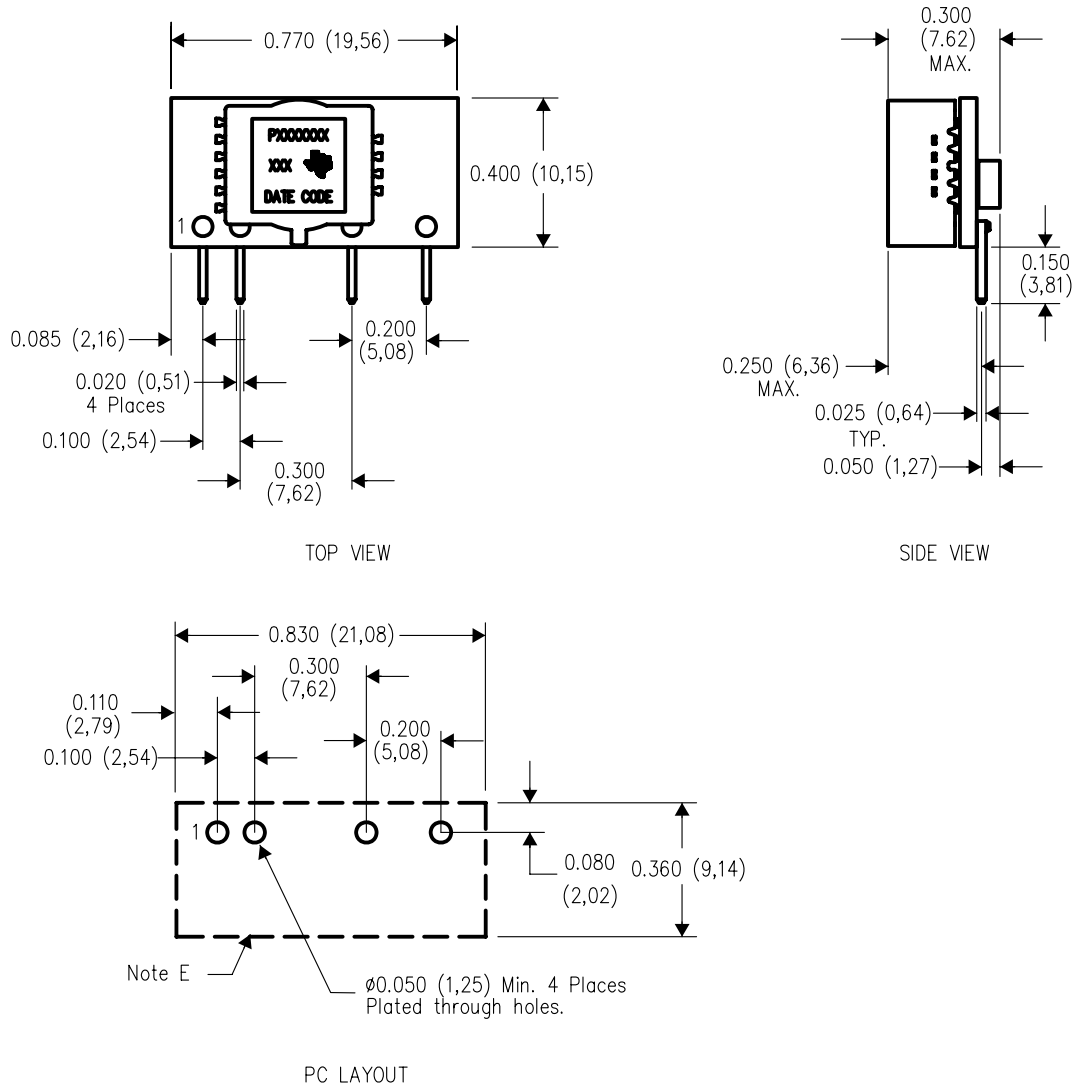

4207975-2/C 08/07

- NOTES:
- A. All linear dimensions are in inches (mm).
 - B. This drawing is subject to change without notice.
 - C. 2 place decimals are ± 0.030 ($\pm 0,76$ mm).
 - D. 3 place decimals are ± 0.010 ($\pm 0,25$ mm).
 - E. Recommended keep out area for user components.
 - F. Pins are 0.020" (0,51) x 0.025" (0,64).
 - G. All pins: Material - Copper Alloy
Finish - Tin (100%) over Nickel plate

EDJ (R-PDSS-T5)

DOUBLE SIDED MODULE

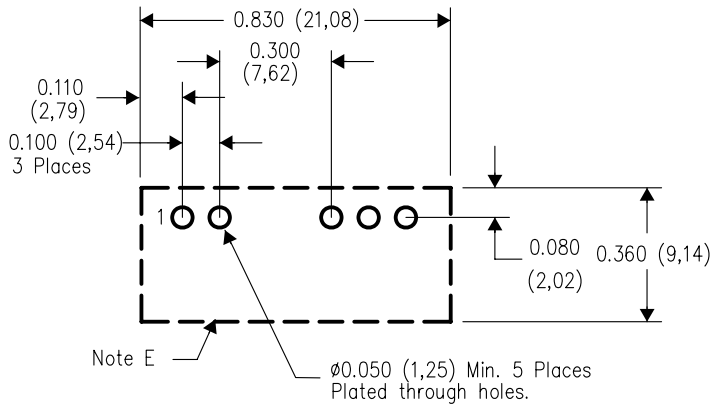
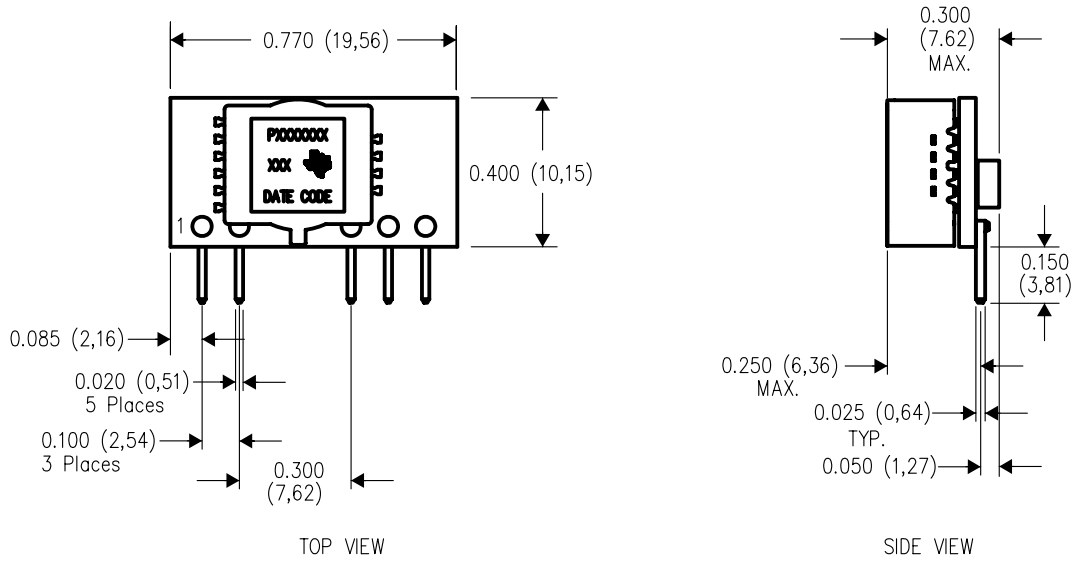

PC LAYOUT

4207975-3/C 08/07

- NOTES:
- A. All linear dimensions are in inches (mm).
 - B. This drawing is subject to change without notice.
 - C. 2 place decimals are ± 0.030 ($\pm 0,76$ mm).
 - D. 3 place decimals are ± 0.010 ($\pm 0,25$ mm).
 - E. Recommended keep out area for user components.
 - F. Pins are 0.020" (0,51) x 0.025" (0,64).
 - G. All pins: Material - Copper Alloy
Finish - Tin (100%) over Nickel plate

IMPORTANT NOTICE

Texas Instruments Incorporated and its subsidiaries (TI) reserve the right to make corrections, modifications, enhancements, improvements, and other changes to its products and services at any time and to discontinue any product or service without notice. Customers should obtain the latest relevant information before placing orders and should verify that such information is current and complete. All products are sold subject to TI's terms and conditions of sale supplied at the time of order acknowledgment.

TI warrants performance of its hardware products to the specifications applicable at the time of sale in accordance with TI's standard warranty. Testing and other quality control techniques are used to the extent TI deems necessary to support this warranty. Except where mandated by government requirements, testing of all parameters of each product is not necessarily performed.

TI assumes no liability for applications assistance or customer product design. Customers are responsible for their products and applications using TI components. To minimize the risks associated with customer products and applications, customers should provide adequate design and operating safeguards.

TI does not warrant or represent that any license, either express or implied, is granted under any TI patent right, copyright, mask work right, or other TI intellectual property right relating to any combination, machine, or process in which TI products or services are used. Information published by TI regarding third-party products or services does not constitute a license from TI to use such products or services or a warranty or endorsement thereof. Use of such information may require a license from a third party under the patents or other intellectual property of the third party, or a license from TI under the patents or other intellectual property of TI.

Reproduction of TI information in TI data books or data sheets is permissible only if reproduction is without alteration and is accompanied by all associated warranties, conditions, limitations, and notices. Reproduction of this information with alteration is an unfair and deceptive business practice. TI is not responsible or liable for such altered documentation. Information of third parties may be subject to additional restrictions.

Resale of TI products or services with statements different from or beyond the parameters stated by TI for that product or service voids all express and any implied warranties for the associated TI product or service and is an unfair and deceptive business practice. TI is not responsible or liable for any such statements.

TI products are not authorized for use in safety-critical applications (such as life support) where a failure of the TI product would reasonably be expected to cause severe personal injury or death, unless officers of the parties have executed an agreement specifically governing such use. Buyers represent that they have all necessary expertise in the safety and regulatory ramifications of their applications, and acknowledge and agree that they are solely responsible for all legal, regulatory and safety-related requirements concerning their products and any use of TI products in such safety-critical applications, notwithstanding any applications-related information or support that may be provided by TI. Further, Buyers must fully indemnify TI and its representatives against any damages arising out of the use of TI products in such safety-critical applications.

TI products are neither designed nor intended for use in military/aerospace applications or environments unless the TI products are specifically designated by TI as military-grade or "enhanced plastic." Only products designated by TI as military-grade meet military specifications. Buyers acknowledge and agree that any such use of TI products which TI has not designated as military-grade is solely at the Buyer's risk, and that they are solely responsible for compliance with all legal and regulatory requirements in connection with such use.

TI products are neither designed nor intended for use in automotive applications or environments unless the specific TI products are designated by TI as compliant with ISO/TS 16949 requirements. Buyers acknowledge and agree that, if they use any non-designated products in automotive applications, TI will not be responsible for any failure to meet such requirements.

Following are URLs where you can obtain information on other Texas Instruments products and application solutions:

Products

Amplifiers	amplifier.ti.com
Data Converters	dataconverter.ti.com
DSP	dsp.ti.com
Clocks and Timers	www.ti.com/clocks
Interface	interface.ti.com
Logic	logic.ti.com
Power Mgmt	power.ti.com
Microcontrollers	microcontroller.ti.com
RFID	www.ti-rfid.com
RF/IF and ZigBee® Solutions	www.ti.com/lprf

Applications

Audio	www.ti.com/audio
Automotive	www.ti.com/automotive
Broadband	www.ti.com/broadband
Digital Control	www.ti.com/digitalcontrol
Medical	www.ti.com/medical
Military	www.ti.com/military
Optical Networking	www.ti.com/opticalnetwork
Security	www.ti.com/security
Telephony	www.ti.com/telephony
Video & Imaging	www.ti.com/video
Wireless	www.ti.com/wireless

Mailing Address: Texas Instruments, Post Office Box 655303, Dallas, Texas 75265
Copyright © 2008, Texas Instruments Incorporated