User's Manual for

DATAMAN-448PRO2

Super fast universal 4x 48-pindrive concurrent multiprogramming system with ISP capability

DATAMAN-448PRO+

Universal 4x 48-pindrive concurrent multiprogramming system with ISP capability

DATAMAN-48PRO2

Super fast universal 48-pindrive Programmer with USB/LPT interface and ISP capability

DATAMAN-48PRO+

Universal 48-pindrive Programmer with USB/LPT interface and ISP capability

DATAMAN-40PRO

Universal 40-pindrive Programmer with USB interface and ISP capability

DATAMAN-MEMPRO

Universal memory Programmer

DATAMAN-T51PRO

MCS51 Series and Atmel AVR Microcontrollers Programmer with ISP capability

DATAMAN-PIKPRO

Microchip PICmicro Programmer with ISP capability

December 2011



COPYRIGHT © 2011 Dataman Programmers Ltd

This document is copyrighted by Dataman Programmers Ltd, United Kingdom. All rights reserved. This document or any part of it may not be copied, reproduced or translated in any form or in any way without the prior written permission of Dataman Programmers Ltd.

The control program is copyrighted by Dataman Programmers Ltd. The control program or any part of it may not be analyzed, disassembled or modified in any form, on any medium, for any purpose.

Information provided in this manual is intended to be accurate at the moment of release, but we continuously improve all our products. Please check for an updated manual on our website at www.dataman.com.

Dataman Programmers Ltd assumes no responsibility for misuse of this manual.

Dataman Programmers Ltd reserves the right to make changes or improvements to the product described in this manual at any time without notice. This manual contains names of companies, software products, etc., which may be trademarks of their respective owners. Dataman Programmers Ltd respects those trademarks.

ZLI-0305B

How to use this manual

This manual explains how to install the control program and how to use your programmer. It is assumed that the user has some experience with PCs and installation of software. Once you have installed the control program we recommend you consult the context sensitive HELP within the control program rather than the printed User's Manual. Revisions are implemented in the context sensitive help before the printed User's Manual.

We continuously update our manual. You may find the latest version from our website (www.dataman.com).

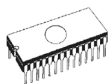

Table of contents

How to use this manual.....	3
Introduction.....	7
Products configuration	9
PC requirements	10
Free additional services:.....	11
Quick Start	12
Detailed description	15
DATAMAN-448PRO2 / DATAMAN-448PRO+	16
Introduction	17
DATAMAN-448PRO2 / DATAMAN-448PRO+ elements	20
Manipulation with the programmed device	21
In-system serial programming by DATAMAN-448PRO2 / DATAMAN-448PRO+	21
Selftest	23
Technical specification	24
DATAMAN-48PRO2 / DATAMAN-48PRO+	29
Introduction	30
DATAMAN-48PRO2 / DATAMAN-48PRO+ elements	33
Connecting DATAMAN-48PRO2 / DATAMAN-48PRO+ to the PC	34
Manipulation with the programmed device	35
In-system serial programming by DATAMAN-48PRO2 / DATAMAN-48PRO+	35
Multiprogramming by DATAMAN-48PRO2 / DATAMAN-48PRO+	37
Selftest	37
Technical specification	38
DATAMAN-40PRO	43
Introduction	44
DATAMAN-40PRO elements	45
Connecting DATAMAN-40PRO to PC	46
Manipulation with the programmed device	46
In-system serial programming by DATAMAN-40PRO	46
Selftest	48
Technical specification	48
DATAMAN-MEMPRO	52
Introduction	53
DATAMAN-MEMPRO elements	54
Connecting DATAMAN-MEMPRO to PC	55
Manipulation with the programmed device	55
Selftest	55
Technical specification	56
DATAMAN-T51PRO	59
Introduction	60
DATAMAN-T51PRO elements	61
Connecting DATAMAN-T51PRO to PC	62
Manipulation with the programmed device	62
In-System serial programming by DATAMAN-T51PRO	62
Selftest	63
Technical specification	64
DATAMAN-PIKPRO	66
Introduction	67
DATAMAN-PIKPRO elements	68

Connecting DATAMAN-PIKPRO programmer to PC	69
Manipulation with the programmed device	69
In-System serial programming by DATAMAN-PIKPRO	69
Selftest.....	70
Technical specification	71
Setup	74
Software setup.....	75
Hardware setup	81
Pg4uw	85
Pg4uw-the programmer software	86
File.....	89
Buffer.....	95
Device.....	101
Programmer.....	128
Options	132
Help	143
Pg4uwMC.....	146
Common notes	156
Maintenance	157
Software	158
Hardware	164
ISP (In-System Programming).....	164
Other.....	166
Troubleshooting and warranty	168
Troubleshooting.....	169
If you have an unsupported target device	169
Warranty terms	170



Conventions used in the manual

References to the control program functions are in bold, e.g. **Load**, **File**, **Device**, etc. References to control keys are written in brackets <>, e.g. <F1>.

Terminology used in the manual:

<i>Device</i>	any kind of programmable integrated circuits or programmable devices
<i>ZIF socket</i>	Zero Insertion Force socket used for insertion of target device
<i>Buffer</i>	part of memory or disk, used for temporary data storage
<i>Printer port</i>	type of PC port (parallel), which is primarily dedicated for printer connection.
<i>USB port</i>	type of PC port (serial), which is dedicated for connecting portable and peripheral devices.
<i>HEX data format</i>	format of data file, which may be read with standard text viewers; e.g. byte 5AH is stored as characters '5' and 'A', which mean bytes 35H and 41H. One line of this HEX file (one record) contains start address and data bytes. All records are secured with checksum.

Introduction



This user's manual covers the following programmers: **DATAMAN-448PRO2**, **DATAMAN-448PRO+**, **DATAMAN-48PRO2**, **DATAMAN-48PRO+**, **DATAMAN-40PRO**, **DATAMAN-MEMPRO**, **DATAMAN-T51PRO** and **DATAMAN-PIKPRO**.

DATAMAN-448PRO2 is a super fast universal 4x 48-pin drive **concurrent multiprogramming system** designed for high volume production programming with minimal operator effort. The chips are programmed at near theoretical maximum programming speed. Using build-in in-circuit serial programming (ISP) connectors the programmer is able to program ISP capable chips in-circuit.

DATAMAN-448PRO+ is extremely fast universal 4x 48-pin drive **concurrent multiprogramming system** designed for high volume production programming with minimal operator effort. The chips are programmed at near theoretical maximum programming speed. Using build-in in-circuit serial programming (ISP) connectors the programmer is able to program ISP capable chips in-circuit.

DATAMAN-48PRO2 is a super fast universal USB/LPT interfaced universal programmer and logic IC tester with 48 powerful pindrivers. Using build-in ISP connector the programmer is able to program ISP capable chips in-circuit. This design allows easily add new devices to the device list. **DATAMAN-48PRO2** is a true universal and a true low cost programmer, providing one of the best "value for money" in today's market.

DATAMAN-48PRO+ is a fast universal USB/LPT interfaced universal programmer and logic IC tester with 48 powerful pindrivers. Using build-in in-circuit serial programming (ISP) connector the programmer is able to program ISP capable chips in-circuit. This design allows easily add new devices to the device list.

DATAMAN-40PRO is a small, fast and powerful USB interfaced programmer of all kinds of programmable devices. Using build-in in-circuit serial programming (ISP) connector the programmer is able to program ISP capable chips in-circuit. It has design, which allows easily add new devices to the device list.

DATAMAN-MEMPRO is a small, fast and powerful USB interfaced programmer for EPROM, EEPROM, Flash EPROM, NVRAM, serial EEPROM and static RAM tester. **DATAMAN-MEMPRO** can be upgraded to **DATAMAN-40PRO**.

DATAMAN-T51PRO is a small, fast and powerful USB interfaced programmer for MCS51 series and Atmel AVR microcontrollers with ISP capability. **DATAMAN-T51PRO** enables also programming serial EEPROM with interface types IIC (24Cxx), Microwire (93Cxx) and SPI (25Cxx). **DATAMAN-T51PRO** can be upgraded to **DATAMAN-40PRO**.

DATAMAN-PIKPRO is a small, fast and powerful USB interfaced programmer for PICmicro® family microcontrollers and serial EEPROM with IIC (24Cxx), Microwire (93Cxx) and SPI (25Cxx) interface types. Using build-in in-circuit serial programming (ISP) connector programmer is able to program PICmicro® family microcontrollers using serial algorithms. **DATAMAN-PIKPRO** can be upgraded to **DATAMAN-40PRO**.

All our programmers work with almost any IBM PC Pentium compatible or higher, portable or desktop personal computers. Programmers use the USB port or parallel (printer) port of PC.

All programmers function flawlessly on Windows operating system (see section PC requirement).

All programmers are driven by an **easy-to-use, control program** with pull-down menus, hot keys and online help. Control program is common for all the above mentioned programmers.

Advanced design, including protection circuits, original brand components and careful manufacturing allows us to provide a **three year warranty** for DATAMAN-448PRO2, DATAMAN-448PRO+, DATAMAN-48PRO2, DATAMAN-48PRO+ and DATAMAN-40PRO and **one year warranty** for DATAMAN-MEMPRO, DATAMAN-T51PRO and DATAMAN-PIKPRO on parts and labour for the programmers (limited 25,000 cycle warranty on ZIF socket). This warranty terms are valid for customers, who purchase a programmer directly from Dataman company. The warranty conditions of Dataman distributors may be different and depending the law system or reseller's warranty policy.

Products configuration

Before installing and using your programmer, please carefully check that your package includes all next mentioned parts. If you find any discrepancy with respective parts list and/or if any of these items are damaged, please contact your distributor immediately.

	DATAMAN-448PRO2 DATAMAN-448PRO+	DATAMAN-48PRO2 DATAMAN-48PRO+	DATAMAN-40PRO	DATAMAN-MEMPRO	DATAMAN-T51PRO	DATAMAN-PIKPRO
programmer	•	•	•	•	•	•
USB cable	•	•	•	•	•	•
LPT cable	-	*	-	-	-	-
internal power supply	•	•	-	-	-	-
external power supply	-	-	•	•	•	•
diagnostic POD	1x	•	•	•	•	•
ISP diagnostic POD	1x	•	-	-	-	-
ISP cable	4x	•	•	•	•	•
ZIF anti-dust cover	4x	•	•	•	•	•
software CD	•	•	•	•	•	•
User's manual	•	•	•	•	•	•
registration card	•	•	•	•	•	•
shipping case	•	•	•	•	•	•

* optional accessories

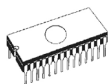

PC requirements

Minimal PC requirements

	2x DATAMAN-448PRO2 2x DATAMAN-448PRO+	DATAMAN-448PRO2 DATAMAN-448PRO+	DATAMAN-48PRO2 DATAMAN-48PRO+	DATAMAN-40PRO	DATAMAN-MEMPRO	DATAMAN-T51PRO	DATAMAN-PIKPRO
OS - Windows	XP	2000	2000	2000	2000	2000	2000
CPU	C2D 2.6GHz	P4	P4	P4	P4	P4	P4
RAM [MB]	1000	512	256	256	256	256	256
free disk space [MB]	400	200	200	200	200	200	200
USB 2.0 high speed	•	•	-	-	-	-	-
USB 1.1	-	-	•	•	•	•	•
LPT	-	-	•	-	-	-	-
CDROM	•	•	•	•	•	•	•

Recommended PC requirements

	2x DATAMAN-448PRO2 2x DATAMAN-448PRO+	DATAMAN-448PRO2 DATAMAN-448PRO+	DATAMAN-48PRO2 DATAMAN-48PRO+	DATAMAN-40PRO	DATAMAN-MEMPRO	DATAMAN-T51PRO	DATAMAN-PIKPRO
OS - Windows	Win 7	Win 7	Win 7	Win 7	Win 7	Win 7	Win 7
CPU	C2Quad	C2D	C2D	C2D	C2D	C2D	C2D
RAM [MB]	2000	1000	1000	512	512	512	512
free disk space [MB]	2000	1000	1000	1000	1000	1000	1000
USB 2.0 high speed	•	•	•	•	•	•	•
LPT IEEE1284	-	-	•	-	-	-	-
CDROM	•	•	•	•	•	•	•

These PC requirements are valid for 2.84/11.2011 version of control program for programmers. For other version see **Help / About control program**.

Free disk space requirement depends also on used IC device size and number of attached programming sites. For large devices the required free space on disk will be approximately $1000MB + 2x \text{ Device size} \times \text{number of programming sites}$ attached to this PC.

Very easy indication, if your PC in hardware/software configuration is good enough for the current software version and current situation with PG4UW/PG4UWMC, is to run Windows task manager (Ctrl+Alt+Del) and see the performance folder. It have to be max. 80% of CPU usage at full run of programming system.

Note:

For convenience, we suggest that you use a supplementary multi I/O card to provide an additional printer port (LPT2 for example), in order to avoid sharing the same LPT port between printer and programmer.

Free additional services:

- free technical support (phone/fax/e-mail).
- free lifetime software update via Web site.

Free software updates are available from our website www.dataman.com.

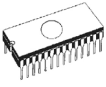

Quick Start

Installing programmer hardware

- connect the USB (or LPT) port of programmer to a USB (or printer) port of PC using supplied cable
- connect the connector of the power supply adapter to the programmer or turn on programmer by switch

Installing the programmer software

Run the installation program from the CD (Setup.exe) and follow the on-screen instructions. For the latest information about the programmer hardware and software release, please visit our website www.dataman.com.

Run the control program



Double click on

After start, control program Pg4uw automatically scans all existing ports and searches for any connected DATAMAN programmer. Program Pg4uw is common for some the DATAMAN's programmers, hence Pg4uw will try to find all supported programmers.

Menu **File** is used for source files manipulation, settings and viewing directory, changes drives, changes start and finish address of buffer for loading and saving files and loading and saving projects.

Menu **Buffer** is used for buffer manipulation, block operation, filling a part of buffer with string, erasing, checksum and of course editing and viewing with other items (find and replace string, printing...).





Menu **Device** is used for a work with selected programmable device: select, read, blank check, program, verify, erase and setting of programming process, serialization and associated file control.

Menu **Programmer** is used for work with programmer.

Menu **Options** is used to view and change various default settings.

Menu **Help** is used for view supported devices and programmers and information about program version.

Programming a device

1. select device: click on 
2. load data into buffer:
 - a) from file: click on 
 - b) from device: insert device to ZIF and click 
3. insert target device to ZIF 



4. check, if the device is blank: click on



5. program device: click on



6. additional verify of device: click on



Detailed description



DATAMAN-448PRO2 / DATAMAN-448PRO+

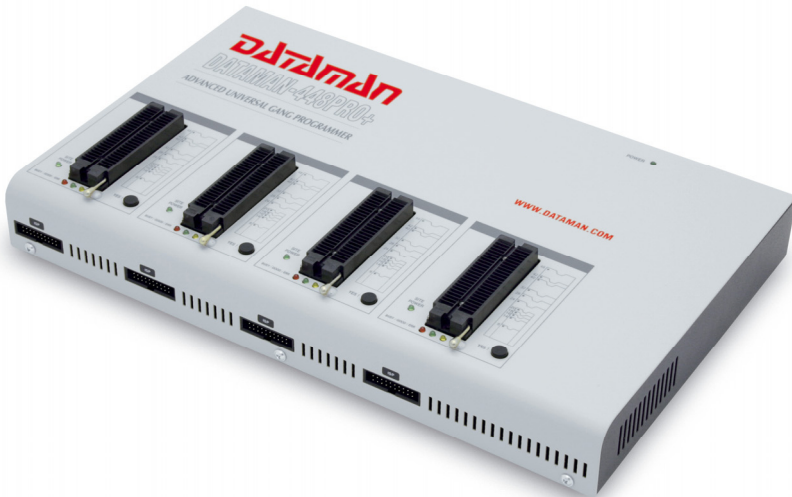

Introduction

DATAMAN-448PRO2 is super fast universal 4x 48-pindrive **concurrent multiprogramming system** designed for high volume production programming with minimal operator effort. The chips are programmed at near theoretical maximum programming speed.

DATAMAN-448PRO+ is extremely fast universal 4x 48-pindrive **concurrent multiprogramming system** designed for high volume production programming with minimal operator effort. The chips are programmed at near theoretical maximum programming speed.

DATAMAN-448PRO2 / DATAMAN-448PRO+ consists of four independent isolated universal programming modules, based on the DATAMAN-48PRO2 / DATAMAN-48PRO+ programmer hardware. Therefore the sockets can run asynchronously (concurrent programming mode). Each programming module starts programming at the moment the chip is detected to be inserted in the socket properly - independently on the status of other programming modules. It result three programming modules works while you replace the programmed chip at the fourth.

Modular construction of hardware - the programming modules works independently - allows for continuing operation when a part of the circuit becomes inoperable. It also makes service quick and easy.

Hands-free operation: asynchronous and concurrent operation allows a chip to begin programming immediately upon insertion of a chip. The operator merely removes the finished chip and inserts a new chip. Operator training is therefore minimized..

DATAMAN-448PRO2 / DATAMAN-448PRO+ supports all kinds of types and silicon technologies of today and tomorrow programmable devices without family-specific module. You can be sure the next devices support require the software update and (if necessary) simple package converter (programming adapter), therefore the ownership cost are minimized.

Using built-in in-circuit serial programming (**ISP**) connector, the programmer is able to program ISP capable chips in circuit.

DATAMAN-448PRO2 / DATAMAN-448PRO+ provides very fast programming due to high-speed FPGA driven hardware and execution of time-critical routines inside of the programmer. It is least fast than competitors in this category, for many chips much faster than most competitors. As a result, when used in production this programmer waits for an operator, and not the other way round.

DATAMAN-448PRO2 / DATAMAN-448PRO+ interfaces with the IBM PC/compatible, portable or desktop personal computers through **USB (2.0)** port.

DATAMAN-448PRO2 / DATAMAN-448PRO+ provides a banana jack for ESD wrist straps connection to easy-to-implement the ESD protection control and also other banana jack for earth wire.

FPGA based totally reconfigurable 48 powerful TTL pindrivers provide H/L/pull_up/pull_down and read capability for each pin of socket. Advanced pindrivers incorporate high-quality high-



speed circuitry to deliver signals without overshoot or ground bounce for all supported devices. Pin drivers operate down to 1.8V so you'll be ready to program the full range of today's advanced low-voltage devices.

DATAMAN-448PRO2 / DATAMAN-448PRO+ performs on each programming module device **insertion test** (wrong or backward position) and **contact check** (poor contact pin-to-socket) before it programs each device. These capabilities, supported by **overcurrent protection** and **signature-byte check** help prevent chip damage due to operator error.

DATAMAN-448PRO2 / DATAMAN-448PRO+ has the selftest capability, which allows run diagnostic part of software to thoroughly check the health of the each programming module.

DATAMAN-448PRO2 / DATAMAN-448PRO+ has a built-in protection circuits for eliminate damage of programmer and/or programmed device due to environment or operator failure. All ZIF socket pins of **DATAMAN-448PRO2 / DATAMAN-448PRO+** programmer are **protected against ESD** up to 15kV.

DATAMAN-448PRO2 / DATAMAN-448PRO+ performs programming verification at the marginal level of supply voltage, which, obviously, improves programming yield, and guarantees long data retention.

Various **socket converters** are available to handle device in PLCC, SOIC, PSOP, SSOP, TSOP, TSSOP, TQFP, QFN (MLF), SDIP, BGA and other packages.

DATAMAN-448PRO2 / DATAMAN-448PRO+ programmer is driven by an **easy-to-use** control program with pull-down menu, hot keys and on-line help. Selecting of device is performed by its class, by manufacturer or simply by typing a fragment of vendor name and/or part number.

Standard device-related commands (read, blank check, program, verify, erase) are boosted by some **test functions** (insertion test, signature-byte check), and some **special functions** (autoincrement, production mode - start immediately after insertion of chip into socket).

All known data formats are supported. Automatic file format detection and conversion during load of file.

The rich-featured **autoincrement function** enables to assign individual serial numbers to each programmed device - or simply increments a serial number, or the function enables to read serial numbers or any programmed device identification signatures from a file.

The software also provides a lot of informations about programmed device. As a special, the **drawings of all available packages**, explanation of **chip labeling** (the meaning of prefixes and suffixes at the chips) for each supported chip are provided.

The software provides full information for ISP implementation: Description of ISP connector pins for currently selected chip, recommended target design around in-circuit programmed chip and other necessary information.

The **remote control** feature allows, that Pg4uw software is flow controlled by other application – either using .BAT file commands or using DLL file. For **DATAMAN-448PRO2 / DATAMAN-448PRO+** is remote control limited for ISP programming only. Please use **DATAMAN-448PRO2AP** for automated off line programming.

Jam files of JEDEC standard JESD-71 are interpreted by **Jam Player**. Jam files are generated by design software which is provided by manufacturer of respective programmable device. Chips are programmer in-ZIF or through ISP connector (IEEE 1149.1 Joint Test Action Group (JTAG) interface).

VME files are interpreted by VME Player. VME file is a compressed binary variation of SVF file and contains high-level IEEE 1149.1 bus operations. VME files are generated by design software which is provided by manufacturer of respective programmable device. Chips are programmer in-ZIF or through ISP connector (IEEE 1149.1 Joint Test Action Group (JTAG) interface).

Multiple devices are possible to program and test via JTAG chain: JTAG chain (ISP-Jam) or JTAG chain (ISP-VME).

It is important to remember that in most cases new devices require **only a software update** due to the DATAMAN-448PRO2 / DATAMAN-448PRO+ is truly universal programmer. With our prompt service you can have new devices can be added to the current list within days!

Advanced design including protection circuits, original brand components and careful manufacturing and burning allows us to provide a **three year warranty** on parts and labour for the DATAMAN-448PRO2 / DATAMAN-448PRO+ (limited 25,000-cycle warranty on ZIF socket).



DATAMAN-448PRO2 / DATAMAN-448PRO+ elements

- 1) 48 pin ZIF socket
- 2) work result LEDs
- 3) power/sleep LED of site
- 4) YES! Button
- 5) ISP connector
- 6) LED indicator power

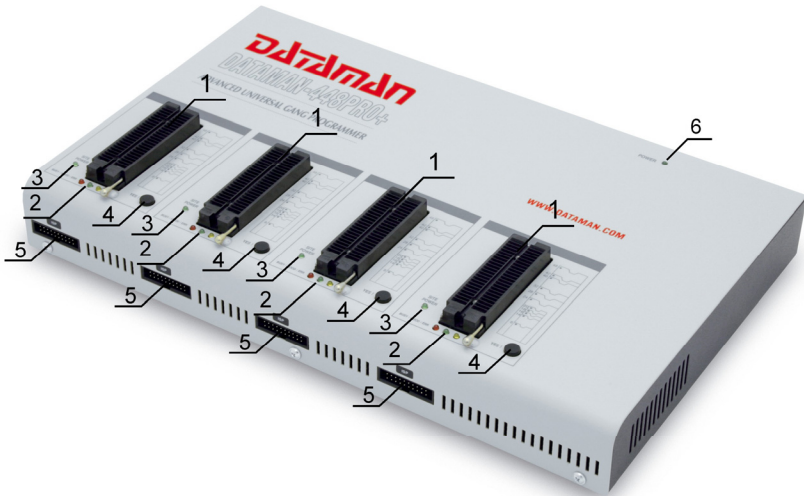

- 7) power supply connector
- 8) power switch
- 9) "GND" connector can be used for grounding of the programmer
"ESD wrist strap" connector is place for attaching of ESD wrist strap
- 10) temperature controlled fans
- 11) type B USB connector for PC ↔ DATAMAN-448PRO2 / DATAMAN-448PRO+
communication cable

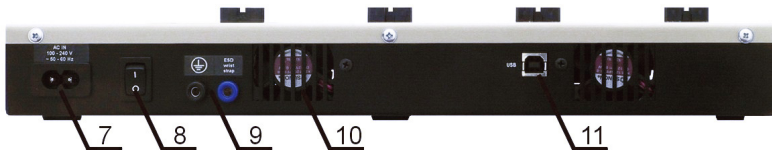

Manipulation with the programmed device

After selection of desired device for your work, you can insert it into the open ZIF socket (the lever is up) and close socket (the lever is down). The correct orientation of the programmed device in ZIF socket is shown on the picture near ZIF socket on the programmer's cover. The programmed device is necessary to insert into the socket also to remove from the socket when LED BUSY light off.

Note: *Programmer's protection electronics protect the target device and the programmer itself against either short or long-term power failures and, partly, also against a PC failure. However, it is not possible to grant the integrity of the target device due to incorrect, user-selected programming parameters. Target device may be not destroyed by forced interruption of the control program (reset or switch-off PC), by removing the physical connection to the programmer, but the content of actually programmed cell may remains undefined. Don't unplug the target device from the ZIF socket during work with devices (LED BUSY shine).*

In-system serial programming by DATAMAN-448PRO2 / DATAMAN-448PRO+

Optimized advanced pindriver deliver programming performance without overshoot or ground bounce for all device technologies. Pin drivers operate down to 1.8V so you'll be ready to program the full range of today's advanced low- voltage devices.

The ISP programming solution performs programming verification at the marginal level of supply voltage, which, obviously, improves programming yield, and guarantees long data retention.

The ISP programming solution provides also the power supply for the target system.

The software provide full information for ISP implementation: Description of ISP connector pins for currently selected chip, recommended target design around in-circuit programmed chip and other necessary information.

For general definition, recommendation and direction about ISP see section **Common notes / ISP** please.

Description of ISP connector

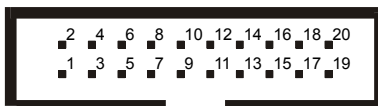

Front view at ISP connector.

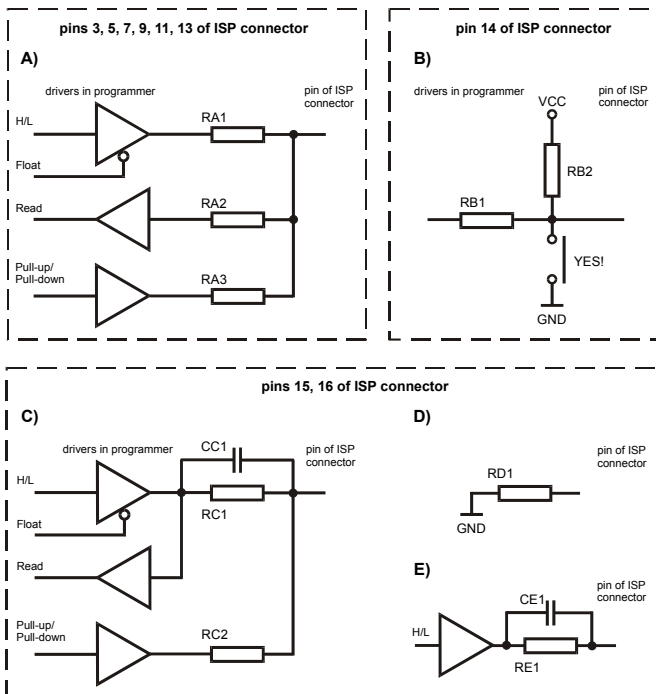
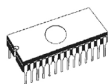

RA1 180R, RA2 1k3, RA3 22k,
 RB1 10k, RB2 10k,
 CC1 1n, RC1 1k3, RC2 22k,
 RD1 22k, CE1 1n, RE1 1k3,

C) Connection of pins 15 and 16 when are configured as logical signal needed for ISP programming

D) E) When pins 15 and 16 are configured as status of LED OK and LED ERROR

D) before first action with desired ISP device

E) after first action with desired ISP device

Notes: When LED OK or LED ERROR ON (shine), this status is presented as logical H, level of H is 1,8V - 5V depend on H level of desired ISP device.

When LED OK or LED ERROR OFF (not shine), this status is presented as logical L, level of L is 0V - 0,4V.

The above mentioned values are provided to understand (and also to exactly calculate) the value of resistors, which isolate (separate) the programmed chip and target system.

Specification of ISP connector pins depends on the device, which you want to program. You can find it in the control SW for programmer (Pg4uw), menu **Device / Device Info (Ctrl+F1)**. Be aware, the ISP programming way of respective device must be selected. It is indicated by (ISP) suffix after name of selected device.

These specifications correspond with application notes published of device manufacturers.

Note: Pin no. 1 is signed by triangle scratch on ISP cable connectors.

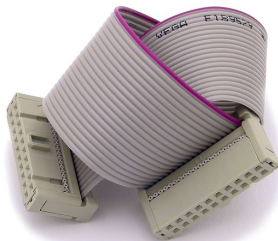

DATAMAN-448PRO2 / DATAMAN-448PRO+ ISP cable

Warnings:

- Use only **attached ISP cable**. When you use other ISP cable (other material, length...), programming may occur unreliable.
- **DATAMAN-448PRO2 / DATAMAN-448PRO+ can supply programmed device** (pin 1 of ISP connector) and target system (pins 19 and 20 of ISP connector) with limitation (see Technical specification / ISP connector).
- **DATAMAN-448PRO2 / DATAMAN-448PRO+ apply programming voltage to target device and checks his value** (target system can modify programming voltage). If the programming voltage is different as expected, no action with target device will be executed.

Selftest

If you feel that your programmer does not react according to your expectation, please run the programmer (ISP connector) selftest using Diagnostic POD (Diagnostic POD for ISP connectors #2), enclosed with the standard delivery package.

Selftest of programmer

- Insert **48 pins diagnostic POD - type I** into ZIF socket of the programmer. **48 pins diagnostic POD - type I** must be inserted as 48 pins device.
- Run selftest of programmer in PG4UW (Programmer / Selftest plus).

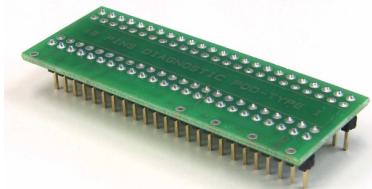

Selftest of ISP connector

- Insert **Diagnostic POD for ISP connectors #2** into ZIF socket of the programmer. **Diagnostic POD for ISP connectors #2** must be inserted as 48 pins device.
- Interconnect 20 pins connector of **Diagnostic POD for ISP connectors #2** with an ISP connector of the programmer with an ISP cable, included in delivery programmer package. Be sure that pins are interconnected properly (i.e. 1-1, 2-2, ..., 20-20).
- Run selftest of ISP connector in PG4UW (Programmer / Selftest ISP connector...).

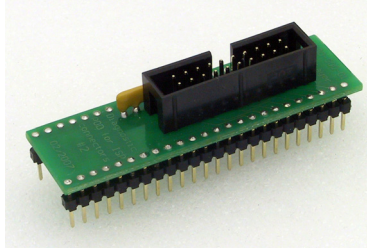

Technical specification

Specification (DATAMAN-448PRO2 / DATAMAN-448PRO+ multiprogramming system)

- 4x universal programming module (4x 48-pin DIL ZIF sockets)
- operation result LEDs, LED power
- USB 2.0 high-speed compatible port
- line power input 100-240VAC/60W max.
- banana jack for ESD wrist straps connection
- banana jack for connection to ground

Specification (valid for each programming module)

HARDWARE

Base unit, DACs

- USB 2.0 high-speed compatible port, up to 480 Mbit/s transfer rate
- on-board intelligence: powerful microprocessor and FPGA based state machine
- three D/A converters for VCCP, VPP1, and VPP2, controllable rise and fall time
- VCCP range 0..8V/1A
- VPP1, VPP2 range 0..26V/1A
- selftest capability

ZIF sockets, pindriver

- 48-pin DIL ZIF (Zero Insertion Force) socket accepts both 300/600 mil devices up to 48-pin
- pindrivers: 48 universal
- VCCP/VPP1/VPP2 can be connected to each pin
- perfect ground for each pin
- FPGA based TTL driver provides H, L, CLK, pull-up, pull-down on all pindriver pins
- analog pindriver output level selectable from 1.8 V up to 26V
- current limitation, overcurrent shutdown, power failure shutdown
- ESD protection on each pin of socket (IEC1000-4-2: 15kV air, 8kV contact)
- continuity test: each pin is tested before every programming operation

ISP connector

- 20-pin male type with miss insertion lock
- 6 TTL pindrivers, provides H, L, CLK, pull-up, pull-down; level H selectable from 1.8V up to 5V to handle all (low-voltage including) devices.
- 1x VCCP voltage (range 2V..7V/100mA)
- programmed chip voltage (VCCP) with both source/sink capability and voltage sense
- 1x VPP voltage (range 2V..25V/50mA)
- target system supply voltage (range 2V..6V/250mA)
- ESD protection on each pin of ISP connector (IEC1000-4-2: 15kV air, 8kV contact)
- two output signals, which indicate state of work result = LED OK and LED Error (active level: min 1.8V)
- input signal, switch YES! equivalent (active level: max 0.8V)

DEVICE SUPPORT

Programmer, in ZIF socket

- EPROM: NMOS/CMOS, 27xxx and 27Cxxx series, with 8/16 bit data width, full support for LV series
- EEPROM: NMOS/CMOS, 28xxx, 28Cxxx, 27EExxx series, with 8/16 bit data width
- Flash EPROM: 28Fxxx, 29Cxxx, 29Fxxx, 29BVxxx, 29LVxxx, 29Wxxx, 49Fxxx series, from 256Kbit to 1Gbit, with 8/16 bit data width, full support for LV series
- Serial E(E)PROM: 24Cxxx, 24Fxxx, 25Cxxx, 45Dxxx, 59Cxxx, 25Fxxx, 25Pxxx, 85xxx, 93Cxxx, NVM3060, MDAXxx series, full support for LV series
- Configuration (EE)PROM: XCFxxx, XC17xxxx, XC18Vxxx, EPCxxx, AT17xxx, 37LVxx
- 1-Wire E(E)PROM: DS1xxx, DS2xxx
- PROM: AMD, Harris, National, Philips/Signetics, Tesla, TI
- NV RAM: Dallas DSxxx, SGS/Inmos MKxxx, SIMTEK STKxxx, XICOR 2xxx, ZMD U63x series
- PLD: Altera: MAX 3000A, MAX 7000A, MAX 7000B, MAX 7000S, MAX7000AE, MAX II
- PLD: Lattice: ispGAL22V10x, ispLS11xxx, ispLS11xxxEA, ispLSI2xxx, ispLSI2xxxA, ispLSI2xxxE, ispLSI2xxxV, ispLSI2xxxVE, ispLSI2xxxVL, LC4xxxB/C/V/ZC, M4-xx/xx, M4A3-xx/xx, M4A5-xx/xx, M4LV-xx/xx
- PLD: Xilinx: XC9500, XC9500XL, XC9500XV, CoolRunner XPLA3, CoolRunner-II
- other PLD: SPLD/CPLD series: AMI, Atmel, AMD-Vantis, Gould, Cypress, ICT, Lattice, NS, Philips, STM, VLSI, TI
- Microcontrollers 48 series: 87x41, 87x42, 87x48, 87x49, 87x50 series
- Microcontrollers 51 series: 87xx, 87Cxxx, 87LVxx, 89Cxxx, 89Sxxx, 89LVxxx, all manufacturers, Philips LPC series
- Microcontrollers Intel 196 series: 87C196 KB/KC/KD/KT/KR/...
- Microcontrollers Atmel AVR: AT90Sxxxx, ATtiny, ATmega series
- Microcontrollers Cypress: CY7Cxxxxx, CY8Cxxxxx
- Microcontrollers ELAN: EM78Pxxx
- Microcontrollers MDT 1xxx and 2xxx series
- Microcontrollers Microchip PICmicro: PIC10xxx, PIC12xxx, PIC16xxx, PIC17Cxxx, PIC18xxx, PIC24xxx, dsPIC series
- Microcontrollers Motorola (Freescale): 68HC05, 68HC08, 68HC11, HCS08, HCS12 series
- Microcontrollers Myson MTV2xx, 3xx, 4xx and 5xx series
- Microcontrollers National: COP8xxx series
- Microcontrollers NEC: uPD78Fxxx series



- Microcontrollers Novatek: NT68xxx series
- Microcontrollers Scenix (Ubicom): SXxxx series
- Microcontrollers SGS-Thomson: ST6xx, ST7xx, ST10xx, STR7xx series
- Microcontrollers TI: MSP430 and MSC121x series
- Microcontrollers ZILOG: Z86/Z89xxx and Z8xxx series
- Microcontrollers other: EM Microelectronic, Fujitsu, Goal Semiconductor, Hitachi, Holtek, Princeton, Macronix, Winbond, Infineon(Siemens), Samsung, Toshiba, ...

I.C. Tester

- TTL type: 54,74 S/LS/ALS/H/HC/HCT series
- CMOS type: 4000, 4500 series
- static RAM: 6116.. 624000
- user definable test pattern generation

Programmer, through ISP connector

- Serial E(E)PROM: IIC series, MW series, SPI series, KEELOQ series, serial data Flash, PLD configuration memories
- Microcontrollers Atmel: AT89Sxxx, AT90Sxxxx, ATtiny, ATmega series
- Microcontrollers Cypress: CY8C2xxxx
- Microcontrollers Elan: EM78Pxxx, EM6xxx series
- Microcontrollers EM Microelectronic: 4 and 8 bit series
- Microcontrollers Microchip PICmicro: PIC10xxx, PIC12xxx, PIC16xxx, PIC17xxx, PIC18xxx, PIC24xxx, dsPIC series
- Microcontrollers Motorola/Freescale: HC11 series, HC908 series (both 5-wire, All-wire), HCS08, HCS12
- Microcontrollers NEC: uPD7xxx series
- Microcontrollers Philips: LPC2xxx series, LPC series, 89xxx series
- Microcontrollers Scenix (Ubicom): SXxxx series
- Microcontrollers TI: MSP430 (both JTAG and BSL series), MSC12xxx series
- PLD: Lattice: ispGAL22xV10x, ispLSI1xxxEA, ispLSI2xxxE, ispLSI2xxxV, ispLSI2xxxVE, ispLSI2xxxVL, M4-xx/xx, M4LV-xx/xx, M4A3-xx/xx, M4A5-xx/xx, LC4xxxB/C/V/ZC
- Various PLD (also by JAM player/JTAG support):
- Altera: MAX 3000A, MAX 7000A, MAX 7000B, MAX 7000S, MAX 9000, MAX II
- Xilinx: XC9500, XC9500XL, XC9500XV, CoolRunner XPLA3, CoolRunner-II

Note: For a full list of supported devices, please visit our website www.dataman.com.

Package support

- support all devices in DIP with default socket
- package support includes DIP, SDIP, PLCC, JLCC, SOIC, SOP, PSOP, SSOP, TSOP, TSOPII, TSSOP, QFP, PQFP, TQFP, VQFP, QFN (MLF), SON, BGA, EBGA, FBGA, VFBGA, UBGA, FTBGA, LAP, CSP, SCSP etc.
- support devices in non-DIP packages up to 48 pins with universal adapters
- programmer is compatible with third-party adapters for non-DIP support

Programming speed

DATAMAN-448PRO2

Device	Size [bits]	Operation	Time
Am29DL640G (parallel NOR Flash)	400080Hx16 (64 Mega)	programming and verify	24 sec
K8P6415UQB (parallel NOR Flash)	400100Hx16 (64 Mega)	programming and verify	13 sec
K9F1G08U0M (parallel NAND Flash)	8400000Hx8 (1 Giga)	programming and verify	122.7 sec
QB25F640S33 (serial Flash)	800200Hx8 (64 Mega)	programming and verify	30.7 sec
AT89C51RD2 (microcontroller)	10000Hx8	programming and verify	14.4 sec
PIC32MX360F512L (microcontroller)	80000Hx8	programming and verify	16.2 sec

Conditions: P4, 2,4GHz, 512 MB RAM, USB 2.0 HS, Windows XP

DATAMAN-448PRO+

Device	Size [bits]	Operation	Time
M50FV080 (parallel Flash)	100000Hx8 (8 Mega)	programming and verify	22 sec
MX28F640C3BT (parallel Flash)	400000Hx16 (64 Mega)	programming and verify	57 sec
K9F1G08U0M (parallel NAND Flash)	8400000Hx8 (1 Giga)	programming and verify	239 sec
AT45D081 (serial Flash)	108000Hx8 (16 Mega)	programming and verify	36 sec
AT89C51RD2 (microcontroller)	10000Hx8	programming and verify	15 sec
PIC18LF452 (microcontroller)	4000Hx16	programming and verify	4 sec

Conditions: P4, 2,4GHz, 512 MB RAM, USB 2.0 HS, Windows XP

SOFTWARE

- **Algorithms:** only manufacturer approved or certified algorithms are used.
- **Algorithm updates:** software updates are available regularly, approx. every 4 weeks, free of charge (Internet download).
- **Main features:** revision history, session logging, on-line help, device and algorithm information

Device operations

- **standard:**
 - intelligent device selection by device type, manufacturer or typed fragment of part name
 - automatic ID-based selection of EPROM/Flash EPROM
 - blank check, read, verify
 - program
 - erase
 - configuration and security bit program
 - illegal bit test
 - checksum
 - interpret the Jam Standard Test and Programming Language (STAPL), JEDEC standard JESD-71
 - interpret the VME files compressed binary variation of SVF files
- **security**
 - insertion test, reverse insertion check
 - contact check
 - ID byte check
- **special**
 - production mode (automatic start immediately after device insertion)



-
- lot of serialization modes (more type of incremental modes, from-file mode, custom generator mode)
 - statistic
 - count-down mode

Buffer operations

- view/edit, find/replace
- fill/copy, move, byte swap, word/dword split
- checksum (byte, word)
- print

File load/save

- no download time because programmer is PC controlled
- automatic file type identification/recognition

Supported file formats

- unformatted (raw) binary
- HEX: Intel, Intel EXT, Motorola S-record, MOS, Exormax, Tektronix, ASCII-SPACE-HEX, ASCII HEX
- Altera POF, JEDEC (ver. 3.0.A), e.g. from ABEL, CUPL, PALASM, TANGO PLD, OrCAD PLD, PLD Designer ISDATA, etc.
- JAM (JEDEC STAPL Format), JBC (Jam STAPL Byte Code), STAPL (STAPL File) JEDEC standard JESD-71
- VME (ispVME file VME2.0/VME3.0)

GENERAL

- supply voltage AC 100-240V, max. 1.2A, 50-60Hz
- power consumption max. 60W active
- dimensions 361x234x56 mm (14.2x9.2x2.2 inch)
- weight (programmer) 3.5kg (7.7 lb)
- operating temperature 5°C ÷ 40°C (41°F ÷ 104°F)
- operating humidity 20%..80%, non condensing

DATAMAN-48PRO2 / DATAMAN-48PRO+





Introduction

DATAMAN-48PRO2 is a super fast universal USB/LPT interfaced universal programmer built to meet the strong demand of the small manufacturing and developer's community for the fast and reliable universal programmer.

DATAMAN-48PRO+ is a fast universal USB/LPT interfaced universal programmer built to meet the strong demand of the small manufacturing and developer's community for the fast and reliable universal programmer.

DATAMAN-48PRO2 / DATAMAN-48PRO+ supports all kinds of types and silicon technologies of today and tomorrow programmable devices without family-specific module. You have freedom to choose the optimal device for your design. Using built-in in-circuit serial programming (**ISP**) connector, the programmer is able to program ISP capable chips in circuit.

DATAMAN-48PRO2 / DATAMAN-48PRO+ isn't only programmer, but also **tester** of TTL/CMOS logic ICs and memories. Furthermore, it allows generating user-definable test pattern sequences.

DATAMAN-48PRO2 / DATAMAN-48PRO+ provides **very fast programming** due to high-speed FPGA driven hardware and execution of time-critical routines inside of the programmer. It is least fast than competitors in this category, for many chips much faster than most competitors. As a result, when used in production this one-socket-programmer waits for an operator, and not the other way round.

DATAMAN-48PRO2 / DATAMAN-48PRO+ interfaces with the IBM PC Pentium compatible or higher, portable or desktop personal computers through USB (2.0/1.1) port or any standard parallel (printer) port. Programmer can utilize power of both USB high-speed port and IEEE1284 (ECP/EPP) high-speed parallel port. Support of both USB/LPT port connections gives you the choice to connect the DATAMAN-48PRO2 / DATAMAN-48PRO+ programmer to any PC, from latest notebook to older desktop without USB port.

DATAMAN-48PRO2 / DATAMAN-48PRO+ provides a banana jack for ESD wrist straps connection to easy-to-implement the ESD protection control and also other banana jack for earth wire.

DATAMAN-48PRO2 / DATAMAN-48PRO+ has a FPGA based totally reconfigurable 48 powerful TTL pindrivers, where provide H/L/pull_up/pull_down and read capability for each pin of socket. Advanced pindrivers incorporate **high-quality high-speed** circuitry to deliver signals without overshoot or ground bounce for all supported devices. Improved pindrivers operate down to 1.8V so you'll be ready to program the full range of today's advanced low-voltage devices.

DATAMAN-48PRO2 / DATAMAN-48PRO+ performs device **insertion test** (wrong or backward position) and **contact check** (poor contact pin-to-socket) before it programs each device. These capabilities, supported by **overcurrent protection** and **signature-byte check** help prevent chip damage due to operator error.

The selftest capability allows running diagnostic part of software to thoroughly check the health of the programmer.

Built-in **protection circuits** eliminate damage of programmer and/or programmed device due environment or operator failure. All the inputs of the DATAMAN-48PRO2 / DATAMAN-48PRO+ programmer, including the ZIF socket, ISP connector, connection to PC and power supply input, are **protected against ESD** up to 15kV.

DATAMAN-48PRO2 / DATAMAN-48PRO+ programmer performs programming **verification** at the **marginal level** of supply voltage, which, obviously, improves programming yield, and guarantees long data retention.

Various **socket converters** are available to handle device in PLCC, SOIC, PSOP, SSOP, TSOP, TSSOP, TQFP, QFN (MLF), SDIP, BGA and other packages.

DATAMAN-48PRO2 / DATAMAN-48PRO+ programmer is driven by an **easy-to-use** control program with pull-down menu, hot keys and on-line help. Selecting of device is performed by its class, by manufacturer or simply by typing a fragment of vendor name and/or part number.

Standard device-related commands (read, blank check, program, verify, erase) are boosted by some **test functions** (insertion test, signature-byte check), and some **special functions** (autoincrement, production mode - start immediately after insertion of chip into socket).

All known data formats are supported. Automatic file format detection and conversion during load of file.

The rich-featured **autoincrement function** enables to assign individual serial numbers to each programmed device - or simply increments a serial number, or the function enables to read serial numbers or any programmed device identification signatures from a file.

The software also provides a lot of informations about programmed device. As a special, the **drawings of all available packages**, explanation of **chip labeling** (the meaning of prefixes and suffixes at the chips) for each supported chip are provided.

The software provides full information for ISP implementation: Description of ISP connector pins for currently selected chip, recommended target design around in-circuit programmed chip and other necessary information.

The **remote control** feature allows being Pg4uw software flow controlled by other application – either using .BAT file commands or using DLL file. DLL file, examples (C/PAS/VBASIC/.NET) and manual are part of standard software delivery.

Jam files of JEDEC standard JESD-71 are interpreted by **Jam Player**. Jam files are generated by design software which is provided by manufacturer of respective programmable device. Chips are programmer in-ZIF or through ISP connector (IEEE 1149.1 Joint Test Action Group (JTAG) interface).

VME files are interpreted by VME Player. VME file is a compressed binary variation of SVF file and contains high-level IEEE 1149.1 bus operations. VME files are generated by design software which is provided by manufacturer of respective programmable device. Chips are programmer in-ZIF or through ISP connector (IEEE 1149.1 Joint Test Action Group (JTAG) interface).



Multiple devices are possible to program and test via JTAG chain: JTAG chain (ISP-Jam) or JTAG chain (ISP-VME).

Attaching of more DATAMAN-48PRO2 / DATAMAN-48PRO+ programmers to the same PC (through USB port) is achieved a **powerful multiprogramming system**, which **support as many chips, as are supported by DATAMAN-48PRO2 / DATAMAN-48PRO+ programmer** and without obvious decreasing of **programming speed**. It is important to know, there is a concurrent multiprogramming - each programmer works independently and each programmer can program different chip, if necessary.

It is important to remember that in most cases new devices require **only a software update** due to the DATAMAN-48PRO2 / DATAMAN-48PRO+ is truly universal programmer. With our prompt service you can have new devices can be added to the current list within days!

Advanced design including protection circuits, original brand components and careful manufacturing and burning allows us to provide a **three year warranty** on parts and labour for the DATAMAN-48PRO2 / DATAMAN-48PRO+ (limited 25,000-cycle warranty on ZIF socket).

DATAMAN-48PRO2 / DATAMAN-48PRO+ elements

- 1) 48 pin ZIF socket
- 2) work result LEDs
- 3) power/sleep LED
- 4) YES! Button
- 5) ISP connector
- 6) power switch
- 7) "GND" connector can be used for grounding of the programmer
"ESD wrist strap" connector is place for attaching of ESD wrist strap



- 8) Power supply connector
- 9) LPT connector for PC ↔ DATAMAN-48PRO2 / DATAMAN-48PRO+ communication cable
- 10) USB connector for PC ↔ DATAMAN-48PRO2 / DATAMAN-48PRO+ communication cable

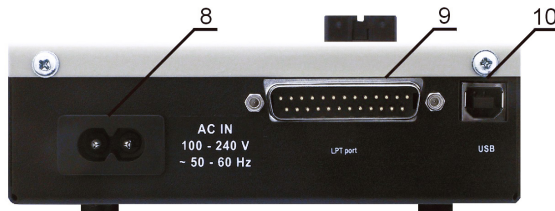

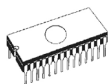

Connecting DATAMAN-48PRO2 / DATAMAN-48PRO+ to the PC

Using USB port

In this case, order of connecting USB cable and power supply to programmer is irrelevant.

Using LPT port

Switch off PC and programmer. Insert the communication cable included with your DATAMAN-48PRO2 / DATAMAN-48PRO+ programmer package to a free printer port on your PC. If your computer is equipped with only one printer port, substitute the programmer cable for the printer cable. Connect the opposite cable end to the programmer. Screw on both connectors to counter-connectors. This is very important. It may be uncomfortable to switch between printer cable and programmer cable, though it is not recommended to operate the DATAMAN-48PRO2 / DATAMAN-48PRO+ programmer through a mechanical printer switch. Use of an electronic printer switch is impossible. But you can install a second multi-I/O in your computer, thus obtaining a supplementary printer port, says LPT2. So your printer may remain on LPT1 while the programmer on LPT2.

Switch on the PC.

Connect the connector "8" to a mains plug using attached cable. At this time all 'work result' LEDs (and 'POWER' LED) light up successive and then switch off. Once the POWER LED lights with low brightness then the DATAMAN-48PRO2 / DATAMAN-48PRO+ programmer is ready to run.

Next run the control program for DATAMAN-48PRO2 / DATAMAN-48PRO+.

Caution! *If you don't want to switch off your PC when connecting the DATAMAN-48PRO2 / DATAMAN-48PRO+, proceed as follows:*

- **When connecting** the programmer to the PC: **FIRST** insert the **communications cable** and **THEN** the **power-supply connector**.
- **When disconnecting** the programmer from the PC: **FIRST** disconnect the **power-supply connector** and **THEN** the **communication cable**.

From DATAMAN-48PRO2 / DATAMAN-48PRO+'s point of view the connecting and disconnecting sequence is irrelevant. Protection circuits on all programmer inputs keep it safe. **But think of your PC please.**

Problems related to the DATAMAN-48PRO2 / DATAMAN-48PRO+ ⇔ PC interconnection, and their removing

If you have any problems with DATAMAN-48PRO2 / DATAMAN-48PRO+ ⇔ PC interconnection, see section **Common notes** please.

Manipulation with the programmed device

After selection of desired device for your work, you can insert into the open ZIF socket (the lever is up) and close socket (the lever is down). The correct orientation of the programmed device in ZIF socket is shown on the picture near ZIF socket on the programmer's cover. The programmed device is necessary to insert into the socket also to remove from the socket when LED BUSY light off.

Note: *Programmer's protection electronics protect the target device and the programmer itself against either short or long-term power failures and, partly, also against a PC failure. However, it is not possible to grant the integrity of the target device due to incorrect, user-selected programming parameters. Target device may be not destroyed by forced interruption of the control program (reset or switch-off PC), by removing the physical connection to the programmer, but the content of actually programmed cell may remains undefined. Don't unplug the target device from the ZIF socket during work with device (LED BUSY shine).*

In-system serial programming by DATAMAN-48PRO2 / DATAMAN-48PRO+

For general definition, recommendation and direction about ISP see section **Common notes / ISP** please.

Description of DATAMAN-48PRO2 / DATAMAN-48PRO+ ISP connector

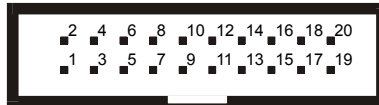

Front view at ISP connector of programmer.



H/L/read driver

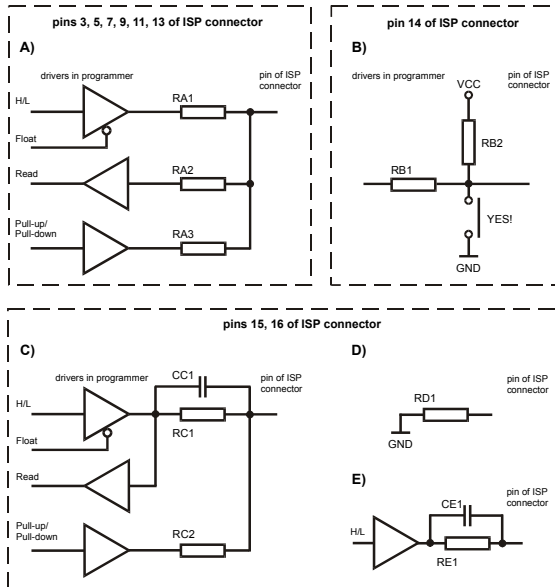

RA1 180R, RA2 1k3, RA3 22k,
 RB1 10k, RB2 10k,
 CC1 1n, RC1 1k3, RC2 22k,
 RD1 22k, CE1 1n, RE1 1k3,

C) Connection of pins 15 and 16 when are configured as logical signal needed for ISP programming

D) E) When pins 15 and 16 are configured as status of LED OK and LED ERROR

D) before first action with desired ISP device

E) after first action with desired ISP device

Notes: When LED OK or LED ERROR ON (shine), this status is presented as logical H, level of H is 1,8V - 5V depend on H level of desired ISP device.

When LED OK or LED ERROR OFF (not shine), this status is presented as logical L, level of L is 0V - 0,4V.

The above mentioned values are provided to understand (and also to exactly calculate) the value of resistors, which isolate (separate) the programmed chip and target system.

Specification of ISP connector pins depends on the device, which you want to program. You can find it in the control SW for programmer (Pg4uw), menu **Device / Device Info (Ctrl+F1)**. Be aware, the ISP programming way of respective device must be selected. It is indicated by (ISP) suffix after name of selected device.

These specifications correspond with application notes published of device manufacturers.

Note: Pin no. 1 is signed by triangle scratch on ISP cable connectors.

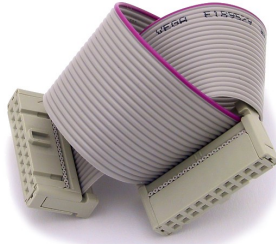

DATAMAN-48PRO2 / DATAMAN-48PRO+ ISP cable

Warnings:

- **When you use DATAMAN-48PRO2 / DATAMAN-48PRO+ as ISP programmer, don't insert device to ZIF socket.**
- **When you program devices in ZIF socket, don't insert ISP cable to ISP connector.**
- **Use only attached ISP cable.** When you use other ISP cable (other material, length...), programming may occur unreliable.
- **DATAMAN-48PRO2 / DATAMAN-48PRO+ can supply programmed device (pin 1 of ISP connector) and target system (pins 19 and 20 of ISP connector) with limitation (see Technical specification / ISP connector).**
- **DATAMAN-48PRO2 / DATAMAN-48PRO+ apply programming voltage to target device and checks his value (target system can modify programming voltage).** If the programming voltage is different as expected, no action with target device will be executed.

Multiprogramming by DATAMAN-48PRO2 / DATAMAN-48PRO+

During installation of Pg4uw at Select Additional Tasks window you check, if is allowed install DATAMAN-48PRO2 / DATAMAN-48PRO+ multiprogramming control support.

For start of DATAMAN-48PRO2 / DATAMAN-48PRO+ multiprogramming is necessary run special control program **Pg4uwMC.exe**. At this program user assign DATAMAN-48PRO2 / DATAMAN-48PRO+ to control programs, may load projects for all DATAMAN-48PRO2 / DATAMAN-48PRO+ and run Pg4uw for every connected and assigned DATAMAN-48PRO2 / DATAMAN-48PRO+.

Selftest

If you feel that your programmer does not react according to your expectation, please run the programmer (ISP connector) selftest using Diagnostic POD (Diagnostic POD for ISP connectors #2), enclosed with the standard delivery package.

Selftest of programmer

- Insert **48 pins diagnostic POD - type I** into ZIF socket of the programmer. **48 pins diagnostic POD - type I** must be inserted as 48 pins device.
- Run selftest of programmer in PG4UW (Programmer / Selftest plus).

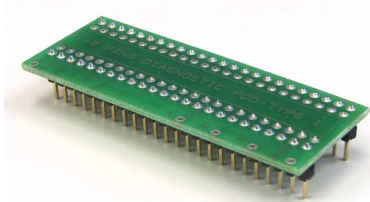

Selftest of ISP connector

- Insert **Diagnostic POD for ISP connectors #2** into ZIF socket of the programmer. **Diagnostic POD for ISP connectors #2** must be inserted as 48 pins device.
- Interconnect 20 pins connector of **Diagnostic POD for ISP connectors #2** with an ISP connector of the programmer with an ISP cable, included in delivery programmer package. Be sure that pins are interconnected properly (i.e. 1-1, 2-2, ..., 20-20).
- Run selftest of ISP connector in PG4UW (Programmer / Selftest ISP connector...).

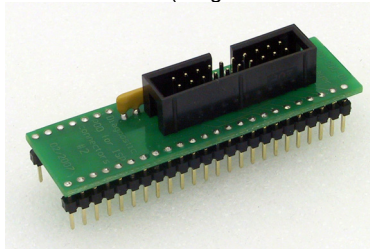

Technical specification

HARDWARE

Base unit, DACs

- USB 2.0 high-speed compatible port, up to 480 Mbit/s transfer rate
- FPGA based IEEE 1284 slave printer port, up to 1MB/s transfer rate
- on-board intelligence: powerful microprocessor and FPGA based state machine
- three D/A converters for VCCP, VPP1, and VPP2, controllable rise and fall time
- VCCP range 0..8V/1A
- VPP1, VPP2 range 0..26V/1A
- selftest capability
- protection against surge and ESD on power supply input, parallel port connection
- banana jack for ESD wrist straps connection
- banana jack for connection to ground

Socket, pindriver

- 48-pin DIL ZIF (Zero Insertion Force) socket accepts both 300/600 mil devices up to 48-pin
- pindrivers: 48 universal

- VCCP / VPP1 / VPP2 can be connected to each pin
- perfect ground for each pin
- FPGA based TTL driver provides H, L, CLK, pull-up, pull-down on all pindriver pins
- analog pindriver output level selectable from 1.8 V up to 26V
- current limitation, overcurrent shutdown, power failure shutdown
- ESD protection on each pin of socket (IEC1000-4-2: 15kV air, 8kV contact)
- continuity test: each pin is tested before every programming operation

ISP connector

- 20-pin male type with miss insertion lock
- 6 TTL pindrivers, provides H, L, CLK, pull-up, pull-down; level H selectable from 1.8V up to 5V to handle all (low-voltage including) devices.
- 1x VCCP voltage (range 2V..7V/100mA)
- programmed chip voltage (VCCP) with both source/sink capability and voltage sense
- and 1x VPP voltage (range 2V..25V/50mA)
- target system supply voltage (range 2V..6V/250mA)
- ESD protection on each pin of ISP connector (IEC1000-4-2: 15kV air, 8kV contact)
- two output signals, which indicate state of work result = LED OK and LED Error (active level: min 1.8V)
- input signal, switch YES! equivalent (active level: max 0.8V)

DEVICE SUPPORT

Programmer, in ZIF socket

- EPROM: NMOS/CMOS, 2708*, 27xxx and 27Cxxx series, with 8/16 bit data width, full support for LV series
- EEPROM: NMOS/CMOS, 28xxx, 28Cxxx, 27EExxx series, with 8/16 bit data width
- Flash EPROM: 28Fxxx, 29Cxxx, 29Fxxx, 29BVxxx, 29LVxxx, 29Wxxx, 49Fxxx series, from 256Kbit to 1Gbit, with 8/16 bit data width, full support for LV series
- Serial E(E)PROM: 24Cxxx, 24Fxxx, 25Cxxx, 45Dxxx, 59Cxxx, 25Fxxx, 25Pxxx, 85xxx, 93Cxxx, NVM3060, MDAxxx series, full support for LV series
- Configuration (EE)PROM: XCFxxx, XC17xxxx, XC18Vxxx, EPCxxx, AT17xxx, 37LVxx
- 1-Wire E(E)PROM: DS1xxx, DS2xxx
- PROM: AMD, Harris, National, Philips/Signetics, Tesla, TI
- NV RAM: Dallas DSxxx, SGS/Inmos MKxxx, SIMTEK STKxxx, XICOR 2xxx, ZMD U63x series
- PLD: Altera: MAX 3000A, MAX 7000A, MAX 7000B, MAX 7000S, MAX7000AE, MAX II
- PLD: Lattice: ispGAL22V10x, ispLSI1xxx, ispLSI1xxxEA, ispLSI2xxx, ispLSI2xxxA, ispLSI2xxxE, ispLSI2xxxV, ispLSI2xxxVE, ispLSI2xxxVL, LC4xxxB/C/V/ZC, M4-xx/xx, M4A3-xx/xx, M4A5-xx/xx, M4LV-xx/xx
- PLD: Xilinx: XC9500, XC9500XL, XC9500XV, CoolRunner XPLA3, CoolRunner-II
- other PLD: SPLD/CPLD series: AMI, Atmel, AMD-Vantis, Gould, Cypress, ICT, Lattice, NS, Philips, STM, VLSI, TI
- Microcontrollers 48 series: 87x41, 87x42, 87x48, 87x49, 87x50 series
- Microcontrollers 51 series: 87xx, 87Cxxx, 87LVxx, 89Cxxx, 89Sxxx, 89LVxxx, all manufacturers, Philips LPC series
- Microcontrollers Intel 196 series: 87C196 KB/KC/KD/KT/KR/...
- Microcontrollers Atmel AVR: AT90Sxxxx, ATtiny, ATmega series
- Microcontrollers Cypress: CY7Cxxxxx, CY8Cxxxxx



- Microcontrollers ELAN: EM78Pxxx
- Microcontrollers MDT 1xxx and 2xxx series
- Microcontrollers Microchip PICmicro: PIC10xxx, PIC12xxx, PIC16xxx, PIC17Cxxx, PIC18xxx, PIC24xxx, dsPIC series
- Microcontrollers Motorola (Freescale): 68HC05, 68HC08, 68HC11, HCS08, HCS12 series
- Microcontrollers Myson MTV2xx, 3xx, 4xx and 5xx series
- Microcontrollers National: COP8xxx series
- Microcontrollers NEC: uPD78Fxxx series
- Microcontrollers Novatek: NT68xxx series
- Microcontrollers Scenix (Ubicom): SXxxx series
- Microcontrollers SGS-Thomson: ST6xx, ST7xx, ST10xx, STR7xx series
- Microcontrollers TI: MSP430 and MSC121x series
- Microcontrollers ZILOG: Z86/Z89xxx and Z8xxx series
- Microcontrollers other: EM Microelectronic, Fujitsu, Goal Semiconductor, Hitachi, Holtek, Princeton, Macronix, Winbond, Infineon(Siemens), Samsung, Toshiba, ...

Programmer, through ISP connector

- Serial E(E)PROM: IIC series, MW series, SPI series, KEELOQ series, serial data Flash, PLD configuration memories
- Microcontrollers Atmel: AT89Sxxx, AT90Sxxxx, ATtiny, ATmega series
- Microcontrollers Cypress: CY8C2xxxx
- Microcontrollers Elan: EM78Pxxx, EM6xxx series
- Microcontrollers EM Microelectronic: 4 and 8 bit series
- Microcontrollers Microchip PICmicro: PIC10xxx, PIC12xxx, PIC16xxx, PIC17xxx, PIC18xxx, PIC24xxx, dsPIC series
- Microcontrollers Motorola/Freescale: HC11 series, HC908 series (both 5-wire, All-wire), HCS08, HCS12
- Microcontrollers NEC: uPD7xxx series
- Microcontrollers Philips: LPC2xxx series, LPC series, 89xxx series
- Microcontrollers Scenix (Ubicom): SXxxx series
- Microcontrollers TI: MSP430 (both JTAG and BSL series), MSC12xxx series
- PLD: Lattice: ispGAL22xV10x, ispLSI1xxxEA, ispLSI2xxxE, ispLSI2xxxV, ispLSI2xxxVE, ispLSI2xxxVL, M4-xx/xx, M4LV-xx/xx, M4A3-xx/xx, M4A5-xx/xx, LC4xxxB/C/V/ZC
- Various PLD (also by JAM player/JTAG support):
 - Altera: MAX 3000A, MAX 7000A, MAX 7000B, MAX 7000S, MAX 9000, MAX II
 - Xilinx: XC9500, XC9500XL, XC9500XV, CoolRunner XPLA3, CoolRunner-II

Notes:

- *Devices marked * are obsolete, programming with additional module*
- *For a full list of supported devices, please visit our website www.dataman.com.*

I.C. Tester

- TTL type: 54,74 S/LS/ALS/H/HC/HCT series
- CMOS type: 4000, 4500 series
- static RAM: 6116.. 624000
- user definable test pattern generation

Package support

- support all devices in DIP with default socket

- package support includes DIP, SDIP, PLCC, JLCC, SOIC, SOP, PSOP, SSOP, TSOP, TSOPII, TSSOP, QFP, PQFP, TQFP, VQFP, QFN (MLF), SON, BGA, EBGA, FBGA, VFBGA, UBGA, FTBGA, LAP, CSP, SCSP etc.
- support devices in non-DIP packages up to 48 pins with universal adapters
- programmer is compatible with third-party adapters for non-DIP support

Programming speed

DATAMAN-48PRO2

Device	Size [bits]	Operation	Time
Am29DL640G (parallel NOR Flash)	400080Hx16 (64 Mega)	programming and verify	24 sec
K8P6415UQB (parallel NOR Flash)	400100Hx16 (64 Mega)	programming and verify	13 sec
K9F1G08U0M (parallel NAND Flash)	8400000Hx8 (1 Giga)	programming and verify	122.7 sec
QB25F640S33 (serial Flash)	800200Hx8 (64 Mega)	programming and verify	30.7 sec
AT89C51RD2 (microcontroller)	10000Hx8	programming and verify	14.4 sec
PIC32MX360F512L (microcontroller)	80000Hx8	programming and verify	16.2 sec

Conditions: P4, 2,4GHz, 512 MB RAM, USB 2.0 HS, Windows XP

DATAMAN-48PRO+

Device	Size [bits]	Operation	Time
M50FW080 (parallel Flash)	100000Hx8 (8 Mega)	programming and verify	22 sec
MX28F640C3BT (parallel Flash)	400000Hx16 (64 Mega)	programming and verify	57 sec
K9F1G08U0M (parallel NAND Flash)	8400000Hx8 (1 Giga)	programming and verify	239 sec
AT45D081 (serial Flash)	108000Hx8 (16 Mega)	programming and verify	36 sec
AT89C51RD2 (microcontroller)	10000Hx8	programming and verify	15 sec
PIC18LF452 (microcontroller)	4000Hx16	programming and verify	4 sec

Conditions: P4, 2,4GHz, 512 MB RAM, USB 2.0 HS, Windows XP

SOFTWARE

- **Algorithms:** only manufacturer approved or certified algorithms are used. Custom algorithms are available at additional cost.
- **Algorithm updates:** software updates are available regularly, approx. every 4 weeks, free of charge (Internet download).
- **Main features:** revision history, session logging, on-line help, device and algorithm information

Device operations

- **standard:**
 - intelligent device selection by device type, manufacturer or typed fragment of part name
 - automatic ID-based selection of EPROM/Flash EPROM
 - blank check, read, verify
 - program
 - erase
 - configuration and security bit program
 - illegal bit test
 - checksum
 - interpret the Jam Standard Test and Programming Language (STAPL), JEDEC standard JESD-71
 - interpret the VME files compressed binary variation of SVF files
- **security**



-
- insertion test, reverse insertion check
 - contact check
 - ID byte check
 - **special**
 - production mode (automatic start immediately after device insertion)
 - lot of serialization modes (more type of incremental modes, from-file mode, custom generator mode)
 - statistic
 - count-down mode

Buffer operations

- view/edit, find/replace
- fill/copy, move, byte swap, word/dword split
- checksum (byte, word)
- print

File load/save

- no download time because programmer is PC controlled
- automatic file type identification

Supported file formats

- unformatted (raw) binary
- HEX: Intel, Intel EXT, Motorola S-record, MOS, Exormax, Tektronix, ASCII-SPACE-HEX,, ASCII HEX
- Altera POF, JEDEC (ver. 3.0.A), e.g. from ABEL, CUPL, PALASM, TANGO PLD, OrCAD PLD, PLD Designer ISDATA, etc.
- JAM (JEDEC STAPL Format), JBC (Jam STAPL Byte Code), STAPL (STAPL File) JEDEC standard JESD-71
- VME (ispVME file VME2.0/VME3.0)

GENERAL

- operating voltage 110-250V AC
- power consumption max. 20W active, about 2W sleep
- dimensions 195x140x55 mm (7.7x5.5x2.2 inch)
- weight 0.9kg (1.98 lb)
- operating temperature 5°C ÷ 40°C (41°F ÷ 104°F)
- operating humidity 20%..80%, non condensing

DATAMAN-40PRO





Introduction

DATAMAN-40PRO is next member of new generation of Windows based DATAMAN universal programmers. Programmer is built to meet the demands of the development labs and field engineers to universal, but portable programmer.

DATAMAN-40PRO is a small, fast and powerful programmer of all kinds of programmable devices. Using build-in in-circuit serial programming (**ISP**) connector the programmer is able to program ISP capable chips in-circuit. **DATAMAN-40PRO** isn't only a programmer, but also a static RAMs tester.

DATAMAN-40PRO provides very fast programming due to high-speed FPGA driven hardware and USB 2.0 full speed port.

DATAMAN-40PRO interfaces with the IBM PC Pentium compatible or higher, portable or desktop personal computers through **USB port**, what is important for new, LPT-port-less computers (notebooks for example).

DATAMAN-40PRO has 40 powerful TTL pindrivers provide H/L/pull_up/pull_down and read capability for each pin of socket. Advanced pindrivers incorporate high-quality high-speed circuitry to deliver signals without overshoot or ground bounce for all supported devices. Pin drivers operate down to 1.8V so you'll be ready to program the full range of today's advanced low-voltage devices.

The programmer performs **device insertion test** (wrong device position in socket) and **contact check** (poor contact pin-to-socket) before it programs each device. These capabilities, supported by **signature-byte check** help prevent chip damage due to operator error.

DATAMAN-40PRO programmer performs programming **verification** at the marginal level of supply voltage, which, obviously, improves programming yield, and guarantees long data retention.

DATAMAN-40PRO programmer is driven by an **easy-to-use** control program with pull-down menu, hot keys and on-line help. Selecting of device is performed by its class, by manufacturer or simply by typing a fragment of vendor name and/or part number.

Standard device-related commands (read, blank check, program, verify, erase) are boosted by some **test functions** (insertion test, signature-byte check), and some **special functions** (autoincrement).

All known data formats are supported. Automatic file format detection and conversion during load of file.

The rich-featured **autoincrement function** enables to assign individual serial numbers to each programmed device - or simply increments a serial number, or the function enables to read serial numbers or any programmed device identification signatures from a file.

The software also provides a lot of informations about programmed device. As a special, the **drawings of all available packages**, explanation of **chip labeling** (the meaning of prefixes and suffixes at the chips) for each supported chip are provided.

The software provides full information for ISP implementation: Description of ISP connector pins for currently selected chip, recommended target design around in-circuit programmed chip and other necessary information.

Various **socket converters** are available to handle device in PLCC, SOIC, SSOP, TSOP, TSSOP, TQFP, QFN (MLF) and other packages.

Advanced design of the DATAMAN-40PRO programmer and careful manufacturing and burning allows us to provide a **three year warranty** on parts and labor for the programmer (limited 25 000-cycle warranty on ZIF socket).

DATAMAN-40PRO elements

- 1) 40 pin ZIF socket
- 2) power/sleep LED
- 3) work result LEDs
- 4) YES! Button

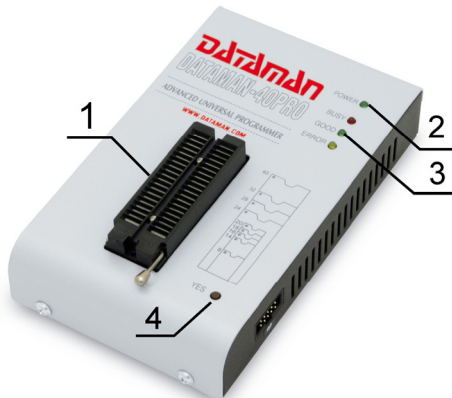

- 5) USB connector for PC ↔ DATAMAN-40PRO communication cable
- 6) Power supply connector

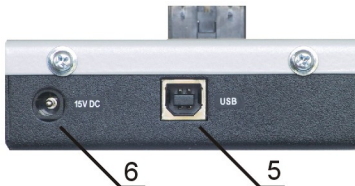

- 7) Connector for ISP

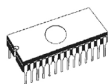

7

Power supply connector



Note: Due to low power consumption of DATAMAN-40PRO in inactive state, it doesn't require power switch. When the power LED indicator glows with a low intensity the DATAMAN-40PRO is in inactive mode.

Connecting DATAMAN-40PRO to PC

For DATAMAN-40PRO order of connecting USB cable and power supply to programmer is irrelevant.

Problems related to the DATAMAN-40PRO ↔ PC interconnection, and their removing

If you have any problems with DATAMAN-40PRO ↔ PC interconnection, see section **Common notes** please.

Manipulation with the programmed device

After selection of desired device for your work, you can insert into the open ZIF socket (the lever is up) and close socket (the lever is down). The correct orientation of the programmed device in ZIF socket is shown on the picture near ZIF socket on the programmer's cover. The programmed device is necessary to insert into the socket also to remove from the socket when LED BUSY light off.

Warning: DATAMAN-40PRO programmer hasn't protection devices, which protect the content of programmed device against critical situations, for example power failures and PC failure (interrupted cable...). Moreover, a device is usually destroyed in the programming mode due to forced interruption of the control program run (Reset or switching the computer off) due to removing the connecting cable, or unplugging the programmed device from the ZIF socket. Incorrectly placed device in the ZIF socket can cause its damage or destruction.

In-system serial programming by DATAMAN-40PRO

For general definition, recommendation and direction about ISP see section **Common notes / ISP** please.

Description of DATAMAN-40PRO ISP connector

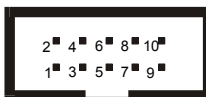

Front view at ISP connector of programmer.

Specification of ISP connector pins depends on the device, which you want to program. You can find it in the control SW for programmer (Pg4uw), menu **Device / Device Info (Ctrl+F1)**. Be aware, the ISP programming way of respective device must be selected. It is indicated by (ISP) suffix after name of selected device.

These specifications correspond with application notes published of device manufacturers.

Note: Pin no. 1 is signed by triangle scratch on ISP cable connectors.

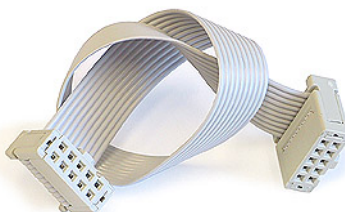

DATAMAN-40PRO ISP cable

Warnings:

- **When you use DATAMAN-40PRO as ISP programmer, don't insert device to ZIF socket.**
- **When you program devices in ZIF socket, don't insert ISP cable to ISP connector.**
- **Use only attached ISP cable.** When you use other ISP cable (other material, length...), programming may occur unreliable.
- **DATAMAN-40PRO can supply programmed device only, but target system cannot supply DATAMAN-40PRO.**
- **DATAMAN-40PRO apply programming voltage to target device and checks his value (target system can modify programming voltage).** If the programming voltage is different as expected, no action with target device will be executed.

Note: H/L/read DATAMAN-40PRO driver

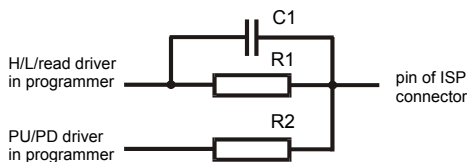

C1=1nF, R1=1k3, R2=22k



Selftest

If you feel that your programmer does not react according to your expectation, please run the programmer selftest using Diagnostic POD, enclosed with the standard delivery package.

- Insert **40 pins diagnostic POD - type I** into ZIF socket of the programmer. **40 pins diagnostic POD - type I** must be inserted as 40 pins device.
- Run selftest of programmer in Pg4uw (Programmer / Selftest plus).

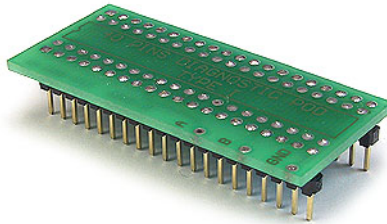

Technical specification

HARDWARE

Programmer

- two D/A converters for VCCP and VPP, controllable rise and fall time
- VCCP range 0..7V/350mA
- VPP range 0..25V/200mA
- USB 2.0/1.1 compatible interface
- selftest capability

ZIF socket, pindriver

- 40-pin DIL ZIF (Zero Insertion Force) socket accepts both 300/600 mil devices up to 40-pins
- pindriver: 40 TTL pindrivers, universal GND/VCC/VPP pindriver
- FPGA based TTL driver provides H, L, CLK, pull-up, pull-down on all pindriver pins, level H selectable from 1.8 V up to 5V
- continuity test: each pin is tested before every programming operation

ISP connector

- 10-pin male type with miss insertion lock
- 6 TTL pindrivers, provides H, L, CLK, pull-up, pull-down; level H selectable from 1.8V up to 5V to handle all (low-voltage including) devices.
- 1x VCCP voltage (range 2V..7V/100mA) and 1x VPP voltage (range 2V..25V/50mA)
- programmed chip voltage (VCCP) with both source/sink capability and voltage sense

Note: *the programmer is not capable to supply a target system from VCCP pin. If you have such demand, use please a DATAMAN-48PRO2 / DATAMAN-48PRO+ programmer*

DEVICE SUPPORT

Programmer, in ZIF socket

- EPROM: NMOS/CMOS, 27xxx and 27Cxxx series, with 8/16 bit data width, full support of LV series (*1*2)
- EEPROM: NMOS/CMOS, 28xxx, 28Cxxx, 27EExxx series, with 8/16 bit data width, full support of LV series (*1*2)
- Flash EPROM: 28Fxxx, 29Cxxx, 29Fxxx, 29BVxxx, 29LVxxx, 29Wxxx, 49Fxxx series, with 8/16 bit data width, full support of LV series (*1*2)
- Serial E(E)PROM: 24Cxxx, 24Fxxx, 25Cxxx, 45Dxxx, 59Cxxx, 25Fxxx, 25Pxxx, 85xxx, 93Cxxx, full support for LV series (*1)
- Configuration (EE)PROM: XCFxxx, 37LVxx, XC17xxxx, EPCxxx, AT17xxx, LV series including
- NV RAM: Dallas DSxxx, SGS/Inmos MKxxx, SIMTEK STKxxx, XICOR 2xxx, ZMD U63x series
- PLD: series: Atmel, AMD-Vantis, Cypress, ICT, Lattice, NS, ... (*1)
- microcontrollers 51 series: 87Cxxx, 87LVxx, 89Cxxx, 89Sxxx, 89LVxxx, LPC series from Atmel, Atmel W&M, Intel, Philips, SST, Winbond (*1*2)
- microcontrollers Atmel AVR: ATTiny, AT90Sxxx, ATmega series (*1*2)
- Microcontrollers Cypress: CY8Cxxxxx
- Microcontrollers ELAN: EM78Pxxx
- Microcontrollers EM Microelectronic: 4 and 8 bit series
- microcontrollers Microchip PICmicro: PIC10xxx, PIC12xxx, PIC16xxx, PIC17Cxxx, PIC18xxx, dsPIC series, 8-40 pins (*1*2)
- microcontrollers Scenix (Ubicom): SXxxx series

Programmer, through ISP connector

- Serial E(E)PROM: IIC series
- Microcontrollers Atmel: AT89Sxxx, AT90Sxxxx, ATTiny, ATmega series
- Microcontrollers Cypress: CY8C2xxxx
- Microcontrollers Elan: EM78Pxxx
- Microcontrollers EM Microelectronic: 4 and 8 bit series
- Microcontrollers Microchip PICmicro: PIC10xxx, PIC12xxx, PIC16xxx, PIC17xxx, PIC18xxx, dsPIC series
- Microcontrollers Philips: LPC series

Notes:

- (*1) - suitable adapters are available for non-DIL packages
- (*2) - there exist only few adapters for devices with more than 40 pins. Therefore think please about more powerful programmer (DATAMAN-48PRO2 / DATAMAN-48PRO+), if you need to program devices with more than 40 pins
- For a full list of supported devices, please visit our website www.dataman.com.

I.C. Tester

- Static RAM: 6116 .. 624000

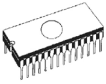

Programming speed

Device	Operation	Mode	Time
27C010	programming and verify	in ZIF	24 sec
AT29C040A	programming and verify	in ZIF	32 sec
AM29F040	programming and verify	in ZIF	69 sec
PIC16C67	programming and verify	in ZIF	10 sec
PIC18F452	programming and verify	in ZIF	7 sec
AT89C52	programming and verify	in ZIF	17 sec
PIC16F876A	programming and verify	ISP	5 sec
PIC12C508	programming and verify	ISP	3 sec

Conditions: P4, 2,4GHz, USB 2.0 HS, Windows XP

SOFTWARE

- **Algorithms:** only manufacturer approved or certified algorithms are used. Custom algorithms are available at additional cost.
- **Algorithm updates:** software updates are available regularly, approx. every 4 weeks, free of charge (Internet download).
- **Main features:** revision history, session logging, on-line help, device and algorithm information

Device operations

- **standard:**
 - intelligent device selection by device type, manufacturer or typed fragment of part name
 - blank check, read, verify
 - program
 - erase
 - configuration and security bit program
 - illegal bit test
 - checksum
- **security**
 - insertion test
 - contact check
 - ID byte check
- **special**
 - auto device serial number increment
 - statistic
 - count-down mode

Buffer operations

- view/edit, find/replace
- fill, copy, move, byte swap, word/dword split
- checksum (byte, word)
- print

File load/save

- no download time because programmer is PC controlled
- automatic file type identification

Supported file formats

- unformatted (raw) binary
- HEX: Intel, Intel EXT, Motorola S-record, MOS, Exormax, Tektronix, ASCII-SPACE-HEX
- JEDEC (ver. 3.0.A), for example from ABEL, CUPL, PALASM, TANGO PLD, OrCAD PLD, PLD Designer ISDATA etc.

GENERAL

- operating voltage 15..20V DC, max. 500mA
- power consumption max. 6W active, 1.4W inactive
- dimensions 160x97x35 mm (6.3x3.8x1.4 inch)
- weight (without external power adapter) ca. 500g (17.65 oz)
- operating temperature 5°C ÷ 40°C (41°F ÷ 104°F)
- operating humidity 20%..80%, non condensing

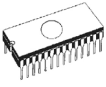

DATAMAN-MEMPRO



Introduction

DATAMAN-MEMPRO is next member of new generation of Windows based DATAMAN specialized programmers. Programmer is built to meet the demands of the development labs and field engineers for a specialized memory programmer.

DATAMAN-MEMPRO can be upgraded to **DATAMAN-40PRO** using the **XPro-Upgrade kit**.

DATAMAN-MEMPRO is small, fast and powerful programmer for virtually all memory types - EPROM, EEPROM, NVRAM, Flash EPROM and serial EEPROM - low voltage types including. **DATAMAN-MEMPRO** isn't only programmer, but also static RAM tester.

DATAMAN-MEMPRO provides very fast programming due to high-speed FPGA driven hardware and USB 2.0 full speed port.

DATAMAN-MEMPRO interfaces with the IBM PC Pentium compatible or higher, portable or desktop personal computers through **USB port**, what is important for new, LPT-port-less computers (notebooks for example).

DATAMAN-MEMPRO has 40 powerful TTL pindrivers provide H/L/pull_up/pull_down and read capability for each pin of socket. Advanced pindrivers incorporate high-quality high-speed circuitry to deliver signals without overshoot or ground bounce for all supported devices. Pin drivers operate down to 1.8V so you'll be ready to program the full range of today's advanced low-voltage devices.

The programmer performs **device insertion test** (wrong device position in socket) and **contact check** (poor contact pin-to-socket) before it programs each device. These capabilities, supported by **signature-byte check** help prevent chip damage due to operator error.

DATAMAN-MEMPRO performs programming **verification** at the marginal level of supply voltage, which, obviously, improves programming yield, and guarantees long data retention.

DATAMAN-MEMPRO is driven by an **easy-to-use** control program with pull-down menus, hot keys and on-line help. Selecting of device is performed by its class, by manufacturer or simply by typing a fragment of vendor name and/or part number.

Standard device-related commands (read, blank check, program, verify, erase) are enhanced by some **test functions** (insertion test, signature-byte check), and some **special functions** (autoincrement).

All known data formats are supported. Automatic file format detection and conversion during load of file.

The rich-featured **autoincrement function** enables to assign individual serial numbers to each programmed device - or simply increments a serial number, or the function enables to read serial numbers or any programmed device identification signatures from a file.



The software also provides a many information about programmed device. As a special, the **drawings of all available packages**, explanation of **chip labeling** (the meaning of prefixes and suffixes at the chips) for each supported chip are provided.

Various socket converters are available to handle device in PLCC, SOIC, SSOP, TSOP, TSSOP and other packages.

DATAMAN-MEMPRO elements

- 1) 40 pin ZIF socket
- 2) power/sleep LED
- 3) work result LEDs
- 4) YES! Button
- 5) Connector for ISP (useable after upgrade to DATAMAN-40PRO only, details: see DATAMAN-40PRO)

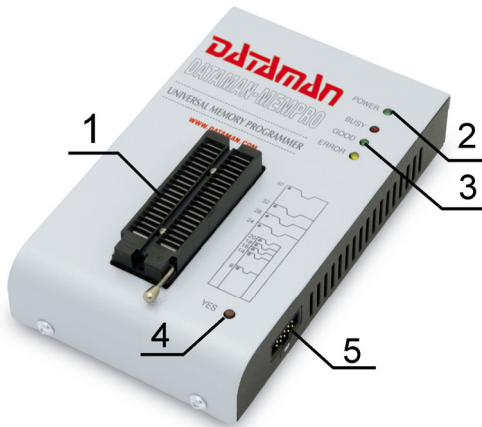

- 6) USB connector for PC ↔ DATAMAN-MEMPRO communication cable
- 7) Power supply connector

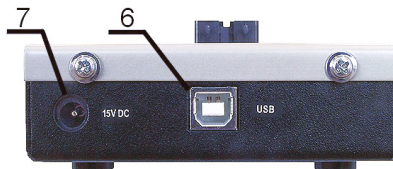

Power supply connector



Connecting DATAMAN-MEMPRO to PC

For DATAMAN-MEMPRO order of connecting USB cable and power supply to programmer is irrelevant.

Problems related to the DATAMAN-MEMPRO ↔ PC interconnection, and their removing

If you have any problems with DATAMAN-MEMPRO ↔ PC interconnection, see section **Common notes** please.

Manipulation with the programmed device

After selection of desired device for your work, you can insert into the open ZIF socket (the lever is up) and close socket (the lever is down). The correct orientation of the programmed device in ZIF socket is shown on the picture near ZIF socket on the programmer's cover. The programmed device is necessary to insert into the socket also to remove from the socket when LED BUSY light off.

Warning: *DATAMAN-MEMPRO programmer hasn't protection devices, which protect the content of programmed device against critical situations, for example power failures and PC failure (interrupted cable...). Moreover, a device is usually destroyed in the programming mode due to forced interruption of the control program run (Reset or switching the computer off) due to removing the connecting cable, or unplugging the programmed device from the ZIF socket. Incorrectly placed device in the ZIF socket can cause its damage or destruction.*

Selftest

If you feel that your programmer does not react according to your expectation, please run the programmer selftest using Diagnostic POD, enclosed with the standard delivery package.

- Insert **40 pins diagnostic POD - type I** into ZIF socket of the programmer. **40 pins diagnostic POD - type I** must be inserted as 40 pins device.
- Run selftest of programmer in Pg4uw (Programmer / Selftest plus).

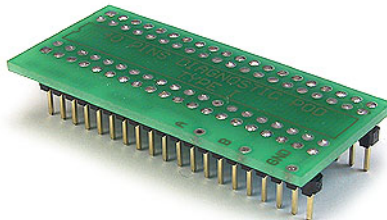

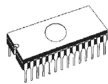

Technical specification

HARDWARE

Programmer

- two D/A converters for VCCP and VPP, controllable rise and fall time
- VCCP range 0..7V/350mA
- VPP range 0..25V/200mA
- USB 2.0/1.1 compatible interface
- selftest capability

ZIF socket, pindriver

- 40-pin DIL ZIF (Zero Insertion Force) socket accepts both 300/600 mil devices up to 40-pins
- pindriver: 40 TTL pindrivers, specialized GND/VCC/VPP pindriver
- FPGA based TTL driver provides H, L, CLK, pull-up, pull-down on all pindriver pins, level H selectable from 1.8 V up to 5V
- continuity test: each pin is tested before every programming operation

ISP connector (useable after upgrade to DATAMAN-40PRO only)

- 10-pin male type with miss insertion lock
- 6 TTL pindrivers, provides H, L, CLK, pull-up, pull-down; level H selectable from 1.8V up to 5V to handle all (low-voltage including) devices.
- 1x VCCP voltage (range 2V..7V/100mA) and 1x VPP voltage (range 2V..25V/50mA)
- programmed chip voltage (VCCP) with both source/sink capability and voltage sense

DEVICE SUPPORT

Programmer

- EPROM: NMOS/CMOS, 2708(*3), 27xxx and 27Cxxx series, with 8/16 bit data width, full support of LV series (*1*2)
- EEPROM: NMOS/CMOS, 28xxx, 28Cxxx, 27EExxx series, with 8/16 bit data width, full support of LV series (*1*2)
- Flash EPROM: 28Fxxx, 29Cxxx, 29Fxxx, 29BVxxx, 29LVxxx, 29Wxxx, 49Fxxx series, with 8/16 bit data width, full support of LV series (*1*2)
- Serial E(E)PROM: 24Cxxx, 24Fxxx, 25Cxxx, 45Dxxx, 59Cxxx, 25Fxxx, 25Pxxx, NVM3060, MDA206x (*3), 85xxx, 93Cxxx, full support for LV series (*1)
- Configuration (EE)PROM: 37LVxx, XC17xxxx, AT17xxx, LV series including (*1)
- NV RAM: Dallas DSxxx, SGS/Inmos MKxxx, SIMTEK STKxxx, XICOR 2xxx, ZMD U63x series

Notes:

- (*1) - suitable adapters are available for non-DIL packages
- (*2) - there exist only few adapters for devices with more than 40 pins. Therefore think please about more powerful programmer(DATAMAN-48PRO2 / DATAMAN-48PRO+), if you need to program devices with more than 40 pins
- (*3) - programming with additional module

- For a full list of supported devices, please visit our website www.dataman.com.

I.C. Tester

- Static RAM: 6116 .. 624000

Programming speed

Device	Operation	Mode	Time
27C010	programming and verify	in ZIF	24 sec
AT29C040A	programming and verify	in ZIF	32 sec
AM29F040	programming and verify	in ZIF	69 sec

Conditions: P4, 2,4GHz, USB 2.0 HS, Windows XP

SOFTWARE

- **Algorithms:** only manufacturer approved or certified algorithms are used.
- **Algorithm updates:** software updates are available regularly, approx. every 4 weeks, free of charge (Internet download).
- **Main features:** revision history, session logging, on-line help, device and algorithm information

Device operations

- **standard:**
 - intelligent device selection by device type, manufacturer or typed fragment of part name
 - blank check, read, verify
 - program
 - erase
 - illegal bit test
 - checksum
- **security**
 - insertion test
 - contact check
 - ID byte check
- **special**
 - auto device serial number increment
 - statistic
 - count-down mode

Buffer operations

- view/edit, find/replace
- fill, copy, move, byte swap, word/dword split
- checksum (byte, word)
- print

File load/save

- no download time because programmer is PC controlled
- automatic file type identification



Supported file formats

- unformatted (raw) binary
- HEX: Intel, Intel EXT, Motorola S-record, MOS, Exormax, Tektronix, ASCII-SPACE-HEX

GENERAL

- operating voltage 15..20V DC, max. 500mA
- power consumption max. 6W active, 1.4W inactive
- dimensions 160x97x35 mm (6.3x3.8x1.4 inch)
- weight (without external power adapter) ca. 500g (17.65 oz)
- operating temperature 5°C ÷ 40°C (41°F ÷ 104°F)
- operating humidity 20%..80%, non condensing

DATAMAN-T51PRO





Introduction

DATAMAN-T51PRO is next member of new generation of Windows based DATAMAN specialized programmers. Programmer is capable to support all today available microcontrollers of MCS51 series (up to 40 pins) and AVR microcontrollers (8-40 pins) by parallel and serial way. DATAMAN-T51PRO has been developed in close cooperation with Atmel W&M., therefore programmer's hardware is focused to support all current and future microcontrollers of Atmel W&M MCS51 family.

DATAMAN-T51PRO can be upgraded to **DATAMAN-40PRO** using the **XPro-Upgrade kit**.

DATAMAN-T51PRO is small, fast and powerful programmer for MCS51 series and Atmel AVR microcontrollers. DATAMAN-T51PRO enables also programming of serial EEPROM with IIC (24Cxx), Microwire (93Cxx) and SPI (25Cxx) interface types. Using build-in in-circuit serial programming (ISP) connector programmer is capable to program MCS51 family microcontrollers and Atmel AVR microcontrollers in serial way.

DATAMAN-T51PRO provides very fast programming due to high-speed FPGA driven hardware and USB 2.0 full speed port.

DATAMAN-T51PRO interfaces with the IBM PC Pentium compatible or higher, portable or desktop personal computers through **USB port**, what is important for new, LPT-port-less computers (notebooks for example).

DATAMAN-T51PRO has 40 powerful TTL pindrivers provide H/L/pull_up/pull_down and read capability for each pin of socket. Advanced pindrivers incorporate high-quality high-speed circuitry to deliver programming without overshoot or ground bounce for all supported devices. Pin drivers operate down to 1.8V so you'll be ready to program the full range of today's advanced low-voltage devices.

The programmer performs **device insertion test** (wrong or backward position) and contact check (poor contact pin-to-socket) before it programs each device. These capabilities, supported by signature-byte check help prevent chip damage due to operator error.

DATAMAN-T51PRO performs programming **verification** at the marginal level of supply voltage, which, obviously, improves programming yield, and guarantees long data retention.

DATAMAN-T51PRO programmer is driven by an **easy-to-use** control program with pull-down menu, hot keys and on-line help. Selecting of device is performed by its class, by manufacturer or simply by typing a fragment of vendor name and/or part number.

Standard device-related commands (read, blank check, program, verify, erase) are boosted by some **test functions** (insertion test, signature-byte check), and some **special functions** (autoincrement).

All known data formats are supported. Automatic file format detection and conversion during load of file.

The rich-featured **autoincrement function** enables to assign individual serial numbers to each programmed device - or simply increments a serial number, or the function enables to read serial numbers or any programmed device identification signatures from a file.

The software also provides a lot of informations about programmed device. As a special, the **drawing of all available packages**, explanation of **chip labeling** (the meaning of prefixes and suffixes at the chips) for each supported chip are provided.

Various socket converters are available to handle device in PLCC, SOIC, SSOP, TSSOP, TQFP, QFN (MLF) and other packages.

DATAMAN-T51PRO elements

- 1) 40 pin ZIF socket
- 2) power/sleep LED
- 3) work result LEDs
- 4) YES! Button
- 5) Connector for ISP

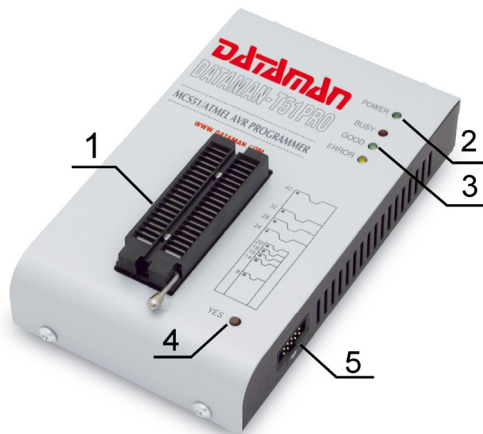

- 6) USB connector for PC ↔ DATAMAN-T51PRO communication cable
- 7) Power supply connector

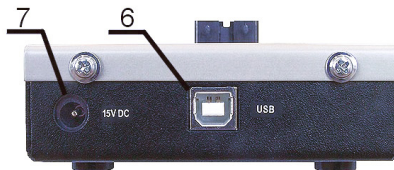

Power supply connector



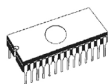

Connecting DATAMAN-T51PRO to PC

For DATAMAN-T51PRO order of connecting USB cable and power supply to programmer is irrelevant.

Problems related to the DATAMAN-T51PRO ⇔ PC interconnection, and their removing

If you have any problems with DATAMAN-T51PRO ⇔ PC interconnection, see section **Common notes** please.

Manipulation with the programmed device

After selection of desired device for your work, you can insert into the open ZIF socket (the lever is up) and close socket (the lever is down). The correct orientation of the programmed device in ZIF socket is shown on the picture near ZIF socket on the programmer's cover. The programmed device is necessary to insert into the socket also to remove from the socket when LED BUSY light off.

Warning: *DATAMAN-T51PRO programmer hasn't protection devices, which protect the content of programmed device against critical situations, for example power failures and PC failure (interrupted cable...). Moreover, a device is usually destroyed in the programming mode due to forced interruption of the control program run (Reset or switching the computer off) due to removing the connecting cable, or unplugging the programmed device from the ZIF socket. Incorrectly placed device in the ZIF socket can cause its damage or destruction.*

In-System serial programming by DATAMAN-T51PRO

For general definition, recommendation and direction about ISP see section **Common notes / ISP** please.

Description of DATAMAN-T51PRO ISP connector

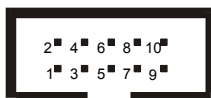

Front view at ISP connector of programmer.

Specification of ISP connector pins depends on the device, which you want to program. You can find it in the control SW for programmer (Pg4uw), menu **Device / Device Info (Ctrl+F1)**. Be aware, the ISP programming way of respective device must be selected. It is indicated by (ISP) suffix after name of selected device.

These specifications correspond with Atmel application note AVR910: In-System

Note: *Pin no. 1 is signed by triangle scratch on ISP cable connectors.*

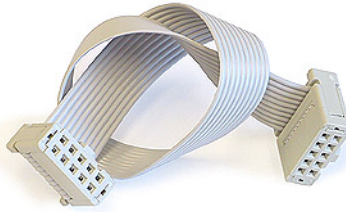

ISP cable of DATAMAN-T51PRO

Warnings:

- **When you use DATAMAN-T51PRO as ISP programmer, don't insert device to ZIF socket.**
- **When you program devices in ZIF socket, don't insert ISP cable to ISP connector.**
- Use only **attached ISP cable**. When you use other ISP cable (other material, length...), programming may occur unreliable.
- **DATAMAN-T51PRO cannot supply target system and target system cannot supply DATAMAN-T51PRO.** Before action with target device DATAMAN-T51PRO check power supply of target system. If this power supply is different as expected, no action with device will be executed.

Note: H/L/read DATAMAN-T51PRO driver.

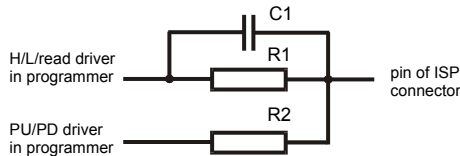

$C1=1\text{nF}$, $R1=1\text{k}\Omega$, $R2=22\text{k}\Omega$

Selftest

If you feel that your programmer does not react according to your expectation, please run the programmer selftest using Diagnostic POD, enclosed with the standard delivery package.

- Insert **40 pins diagnostic POD - type I** into ZIF socket of the programmer. **40 pins diagnostic POD - type I** must be inserted as 40 pins device.
- Run selftest of programmer in Pg4uw (Programmer / Selftest plus).

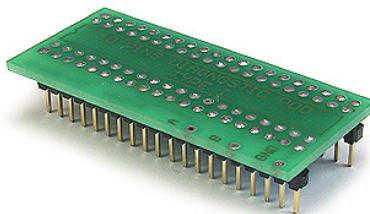

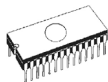

Technical specification

HARDWARE

Socket, pin drivers and DACs

- two D/A converters for VCCP and VPP, controllable rise and fall time
- VCCP range 0..7V/350mA
- VPP range 0..25V/200mA
- USB 2.0/1.1 compatible interface
- selftest capability

ZIF socket, pindriver

- 40-pin DIL ZIF (Zero Insertion Force) socket accepts both 300/600 mil devices up to 40-pins
- pindriver: 40 TTL pindrivers, universal GND/VCC/VPP pindriver
- FPGA based TTL driver provides H, L, CLK, pull-up, pull-down on all pindriver pins, level H selectable from 1.8 V up to 5V
- continuity test: each pin is tested before every programming operation

ISP connector

- 10-pin male type with miss insertion lock
- 6 TTL pindrivers, provides H, L, CLK, pull-up, pull-down; level H selectable from 1.8V up to 5V to handle all (low-voltage including) devices.
- 1x VCCP voltage (range 2V..7V/100mA) and 1x VPP voltage (range 2V..25V/50mA)
- programmed chip voltage (VCCP) with both source/sink capability and voltage sense

DEVICE SUPPORT

Programmer, in ZIF socket

- microcontrollers MCS51 series: 87Cxxx, 87LVxx, 89Cxxx, 89Sxxx, 89LVxxx, LPC series from Atmel, Atmel W&M, Intel, Philips, SST, Winbond, ... 8-40 pins (*1)
- microcontrollers Atmel AVR: ATtiny, AT90Sxxx, ATmega series (parallel and serial mode), 8-40 pins (*1)
- Serial E(E)PROM: 24Cxxx, 24Fxxx, 25Cxxx, 59Cxxx, 85xxx, 93Cxxx series

Programmer, through ISP connector

- Microcontrollers Atmel: AT89Sxxx, AT90Sxxxx, ATtiny, ATmega series
- Microcontrollers Philips: LPC series

Note: For a full list of supported devices, please visit our website www.dataman.com.

Programming speed

Device	Operation	Time
AT89C52	programming and verify	17 sec
T87C5111	programming and verify	14 sec

Conditions:

P4, 2,4GHz, USB 2.0 HS, Windows XP

SOFTWARE

- **Algorithms:** only manufacturer approved or certified algorithms are used.
- **Algorithm updates:** software updates are available regularly, approx. every 4 weeks, free of charge (Internet download).
- **Main features:** revision history, session log, on-line help, device and algorithm information

Device operations

- **standard:**
 - intelligent device selection by device type, manufacturer or typed fragment of part name
 - blank check, read, verify
 - program
 - erase
 - illegal bit test
 - checksum
- **security**
 - insertion test
 - contact check
 - ID byte check
- **special**
 - auto device serial number increment
 - statistic
 - count-down mode

Buffer operations

- view/edit, find/replace
- fill/copy, move, byte swap, word/dword split
- checksum (byte, word)
- print

File load/save

- no download time because programmer is PC controlled
- automatic file type identification

Supported file formats

- unformatted (raw) binary
- HEX: Intel, Intel EXT, Motorola S, MOS, Exormax, Tektronix, ASCII-space-HEX

GENERAL

- operating voltage 15..20V DC, max. 500mA
- power consumption max. 6W active, 1.4W inactive
- dimensions 160x97x35 mm (6.3x3.8x1.4 inch)
- weight (without external power adapter) ca. 500g (17.65 oz)
- operating temperature 5°C ÷ 40°C (41°F ÷ 104°F)
- operating humidity 20%..80%, non condensing

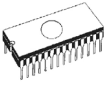

DATAMAN-PIKPRO



Introduction

DATAMAN-PIKPRO is next member of the new generation of Windows based DATAMAN specialized programmers. Programmer is capable to support all currently available Microchip™ PICmicro® series microcontrollers (8-40 pins) using parallel and serial algorithms. The DATAMAN-PIKPRO programmer isn't development grade programmer, but meets all Microchip's requirements to manufacturing grade of programmers. The DATAMAN-PIKPRO has been developed in close cooperation with Microchip™ company, therefore programmer's hardware is focused to support all current and future PICmicro® family microcontrollers.

DATAMAN-PIKPRO can be upgraded to **DATAMAN-40PRO** using the **XPro-Upgrade kit**.

DATAMAN-PIKPRO is a small, fast and powerful programmer for PICmicro® family microcontrollers and serial EEPROM with IIC (24Cxx), Microwire (93Cxx) and SPI (25Cxx) interface types. Using build-in in-circuit serial programming (ISP) connector programmer is able to program PICmicro® family microcontrollers using serial algorithms.

DATAMAN-PIKPRO provides very fast programming due to high-speed FPGA driven hardware and USB 2.0 full speed port.

DATAMAN-PIKPRO interfaces with the IBM PC Pentium compatible or higher, portable or desktop personal computers through **USB port**, what is important for new, LPT-port-less computers (notebooks for example).

DATAMAN-PIKPRO has 40 powerful TTL pindrivers provide H/L/pull_up/pull_down and read capability for each pin of socket. Advanced pindrivers incorporate high-quality high-speed circuitry to deliver signals without overshoot or ground bounce for all supported devices. Pin drivers operate down to 1.8V so you'll be ready to program the full range of today's advanced low-voltage devices.

The programmer performs **device insertion test** (wrong device position in socket) and **contact check** (poor contact pin-to-socket) before it programs each device. These capabilities, supported by **signature-byte check** help prevent chip damage due to operator error.

DATAMAN-PIKPRO programmer performs programming **verification** at the marginal level of supply voltage, which, obviously, improves programming yield, and guarantees long data retention.

DATAMAN-PIKPRO programmer is driven by an **easy-to-use** control program with pull-down menu, hot keys and on-line help. Selecting of device is performed by its class, by manufacturer or simply by typing a fragment of vendor name and/or part number.

Standard device-related commands (read, blank check, program, verify, erase) are boosted by some **test functions** (insertion test, signature-byte check), and some **special functions** (autoincrement).

All known data formats are supported. Automatic file format detection and conversion during load of file.



The rich-featured **autoincrement function** enables to assign individual serial numbers to each programmed device - or simply increments a serial number, or the function enables to read serial numbers or any programmed device identification signatures from a file.

The software also provides a lot of informations about programmed device. As a special, the **drawing of all available packages**, explanation of **chip labeling** (the meaning of prefixes and suffixes at the chips) for each supported chip are provided.

Various socket converters are available to handle device in PLCC, SOIC, SSOP, TSSOP, TQFP and other packages.

DATAMAN-PIKPRO elements

- 1) 40 pin ZIF socket
- 2) power/sleep LED
- 3) work result LEDs
- 4) YES! Button
- 5) Connector for ISP

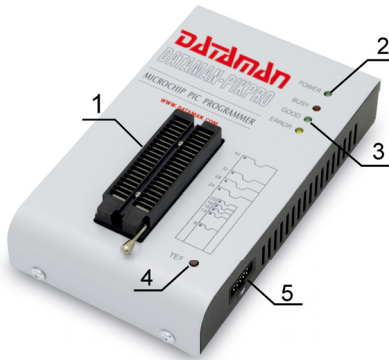

- 6) USB connector for PC ↔ DATAMAN-PIKPRO communication cable
- 7) Power supply connector

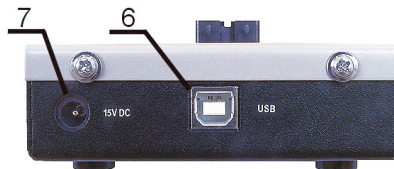

Power supply connector



Connecting DATAMAN-PIKPRO programmer to PC

For DATAMAN-PIKPRO order of connecting USB cable and power supply to programmer is irrelevant.

Problems related to the DATAMAN-PIKPRO ⇔ PC interconnection, and their removing

If you have any problems with DATAMAN-PIKPRO ⇔ PC interconnection, see section **Common notes** please.

Manipulation with the programmed device

After selection of desired device for your work, you can insert into the open ZIF socket (the lever is up) and close socket (the lever is down). The correct orientation of the programmed device in ZIF socket is shown on the picture near ZIF socket on the programmer's cover. The programmed device is necessary to insert into the socket also to remove from the socket when LED BUSY light off.

Warning! *DATAMAN-PIKPRO programmer hasn't protection devices, which protect the content of programmed device against critical situations, for example power failures and PC failure (interrupted cable...). Moreover, a device is usually destroyed in the programming mode due to forced interruption of the control program run (Reset or switching the computer off) due to removing the connecting cable, or unplugging the programmed device from the ZIF socket. Incorrectly placed device in the ZIF socket can cause its damage or destruction.*

In-System serial programming by DATAMAN-PIKPRO

For general definition, recommendation and direction about ISP see section **Common notes** / **ISP** please.

Description of DATAMAN-PIKPRO ISP connector

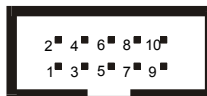

Front view at ISP connector of programmer.

Specification of ISP connector pins depends on the device, which you want to program. You can find it in the control SW for programmer (Pg4uw), menu **Device / Device Info (Ctrl+F1)**. Be aware, the ISP programming way of respective device must be selected. It is indicated by (ISP) suffix after name of selected device.

These specifications correspond with Microchip application note: In-Circuit Serial Programming™ (ICSP™) Guide.



Note: Pin no. 1 is signed by triangle scratch on ISP cable connectors.

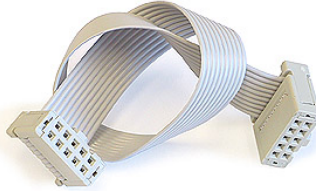

ISP cable of DATAMAN-PIKPRO

Warnings:

- **When you use DATAMAN-PIKPRO as ISP programmer, don't insert device to ZIF socket.**
- **When you program devices in ZIF socket, don't insert ISP cable to ISP connector.**
- **Use only attached ISP cable.** When you use other ISP cable (other material, length...), programming may occur unreliable.
- **DATAMAN-PIKPRO can supply programmed device only, but target system cannot supply DATAMAN-PIKPRO.**
- **DATAMAN-PIKPRO apply programming voltage to target device and checks his value (target system can modify programming voltage).** If the programming voltage is different as expected, no action with target device will be executed.

Note: H/L/read DATAMAN-PIKPRO driver

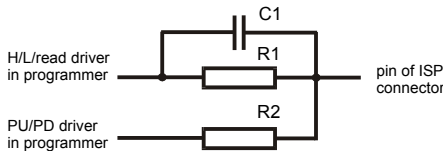

C1=1nF, R1=1k3, R2=22k

Selftest

If you feel that your programmer does not react according to your expectation, please run the programmer selftest using Diagnostic POD, enclosed with the standard delivery package.

- Insert **40 pins diagnostic POD - type I** into ZIF socket of the programmer. **40 pins diagnostic POD - type I** must be inserted as 40 pins device.
- Run selftest of programmer in Pg4uw (Programmer / Selftest plus).

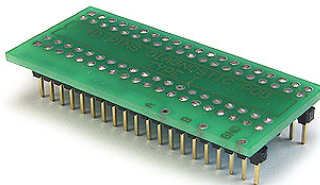

Technical specification

HARDWARE

Socket, pin drivers and DACs

- two D/A converters for VCCP and VPP, controllable rise and fall time
- VCCP range 0..7V/350mA
- VPP range 0..25V/200mA
- USB 2.0/1.1 compatible interface
- selftest capability

ZIF socket, pindriver

- 40-pin DIL ZIF (Zero Insertion Force) socket accepts both 300/600 mil devices up to 40-pins
- pindriver: 40 TTL pindrivers, universal GND/VCC/VPP pindriver
- FPGA based TTL driver provides H, L, CLK, pull-up, pull-down on all pindriver pins, level H selectable from 1.8 V up to 5V
- continuity test: each pin is tested before every programming operation

ISP connector

- 10-pin male type with miss insertion lock
- 6 TTL pindrivers, provides H, L, CLK, pull-up, pull-down; level H selectable from 1.8V up to 5V to handle all (low-voltage including) devices.
- 1x VCCP voltage (range 2V..7V/100mA) and 1x VPP voltage (range 2V..25V/50mA)
- programmed chip voltage (VCCP) with both source/sink capability and voltage sense

DEVICE SUPPORT

Programmer, in ZIF socket

- microcontrollers Microchip™ PICmicro®: PIC10xxx, PIC12xxx, PIC14xxx, PIC16xxx, PIC17xxx, PIC18xxx, dsPIC series, 8 to 40 pins (*1)
- Serial E(E)PROM: 17Cxxx, 24Cxxx, 24Fxxx, 25Cxxx, 59Cxxx, 85xxx, 93Cxxx series

Programmer, through ISP connector

- Microcontrollers Microchip PICmicro: PIC10xxx, PIC12xxx, PIC16xxx, PIC17xxx, PIC18xxx, dsPIC series

Notes:

- (*1) - suitable adapters are available for non-DIL packages and devices with more than 40 pins
- For a full list of supported devices, please visit our website www.dataman.com.

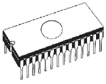

Programming speed

Device	Operation	Mode	Time A
PIC16C67	programming and verify	in ZIF	12 sec
PIC18F452	programming and verify	in ZIF	8 sec
PIC16F876A	programming and verify	ISP	5 sec
PIC12C508	programming and verify	ISP	3 sec

Conditions: P4, 2,4GHz, USB 2.0 HS, Windows XP

SOFTWARE

- **Algorithms:** only manufacturer approved or certified algorithms are used.
- **Algorithm updates:** software updates are available regularly, approx. every 4 weeks, free of charge (Internet download).
- **Main features:** revision history, session logging, on-line help, device and algorithm information

Device operations

- **standard:**
 - intelligent device selection by device type, manufacturer or typed fragment of part name
 - blank check, read, verify
 - program
 - erase
 - configuration and security bit program
 - illegal bit test
 - checksum
- **security**
 - insertion test
 - contact check
 - ID byte check
- **special**
 - auto device serial number increment
 - statistic
 - count-down mode

Buffer operations

- view/edit, find/replace
- fill, copy, move, byte swap, word/dword split
- checksum (byte, word)
- print

File load/save

- no download time because programmer is PC controlled
- automatic file type identification

Supported file formats

- unformatted (raw) binary
- HEX: Intel, Intel EXT, Motorola S-record, MOS, Exormax, Tektronix, ASCII-SPACE-HEX

GENERAL

- operating voltage 15..20V DC, max. 500mA
- power consumption max. 6W active, 1.4W inactive
- dimensions 160x97x35 mm (6.3x3.8x1.4 inch)
- weight (without external power adapter) ca. 500g (17.65 oz)
- operating temperature 5°C ÷ 40°C (41°F ÷ 104°F)
- operating humidity 20%..80%, non condensing

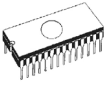

Setup

The programmer package contains a CD with the control program, useful utilities and additional information. The permission to freely copy the content of the CD is granted in order to demonstrate how DATAMAN's programmers work.

For programmers connected through USB (LPT) port, control program requires correctly installed USB driver

We recommended install software before connecting programmer to PC to avoid unwanted complication during installation.

Software setup

Insert delivered CD to your CD drive and install program starts automatically (if not, run setup.exe). Install program will guide you through the installation process and will do all the necessary steps before you can first run the control program.

Step 1.

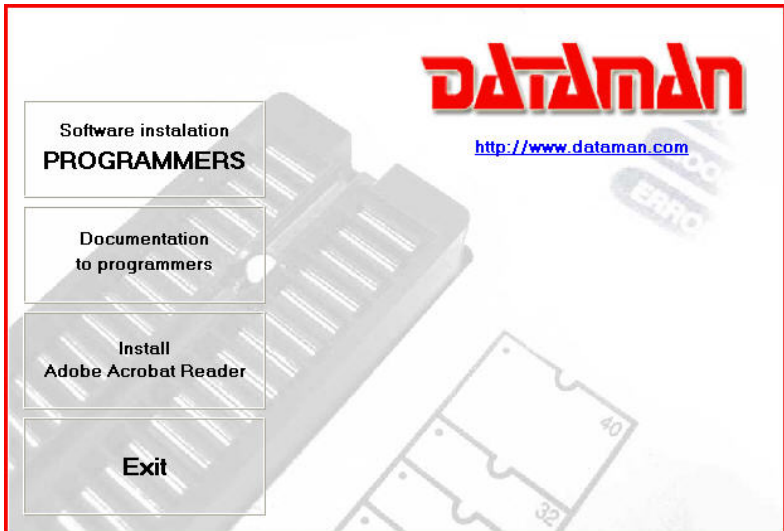

Click on "Software installation PROGRAMMERS" button.

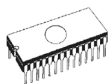

Step 2.



Click on "Next" button

Step 3.

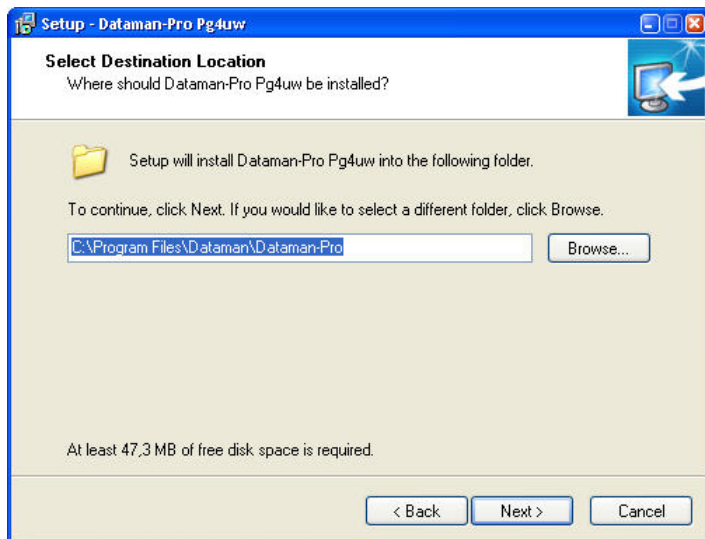

For change default folder click on "Browse" button, select the destination folder. Then click on "Next" button

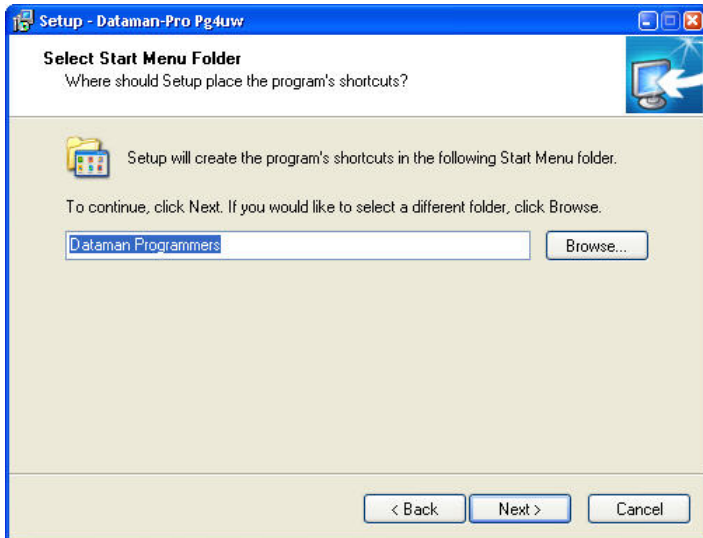
Step 4.

For change default folder click on "Browse" button, select the destination folder. Then click on "Next" button

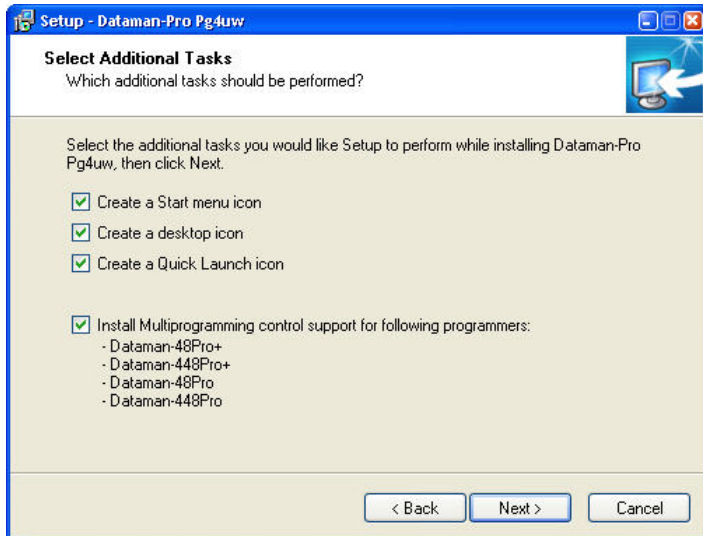
Step 5.

Check if "Install Multiprogramming control support" is selected. Change default setting, if you want. Then click on "Next" button

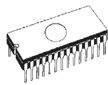

Step 6.

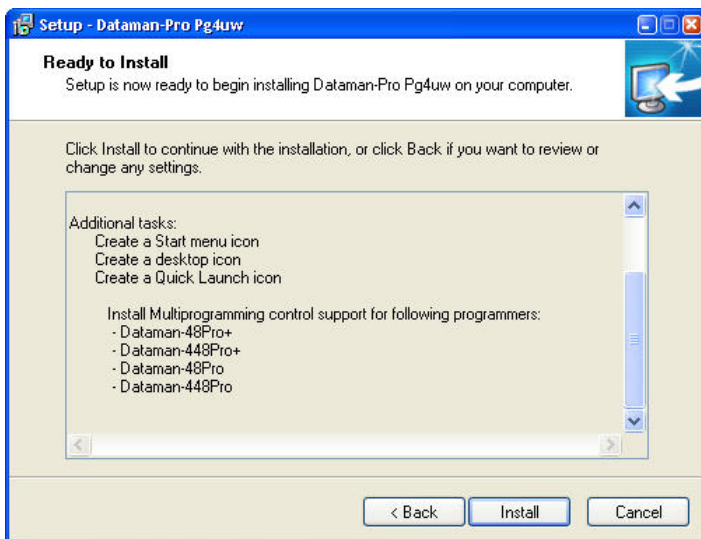

Check your setting and then click on “Install” button

Step 7.

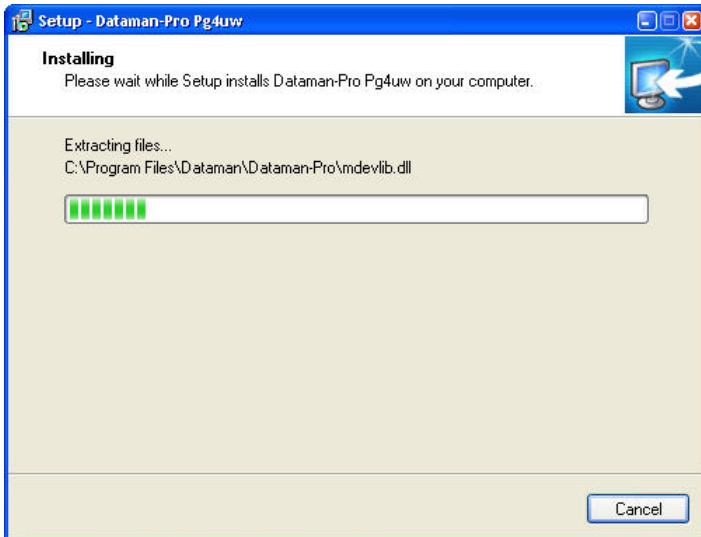

Installation process will start.

Step 8.

For first time installation of current version of driver only.

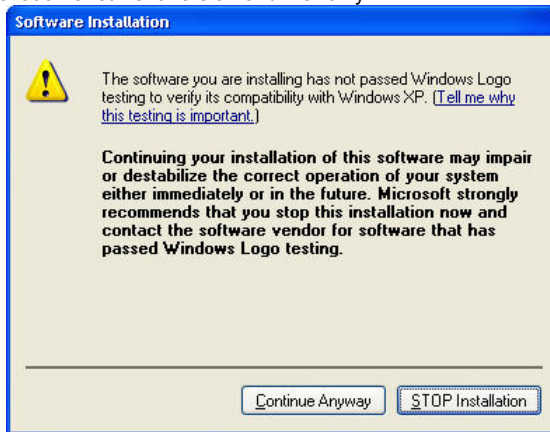

Click on "Continue Anyway" button.

For Windows Vista:

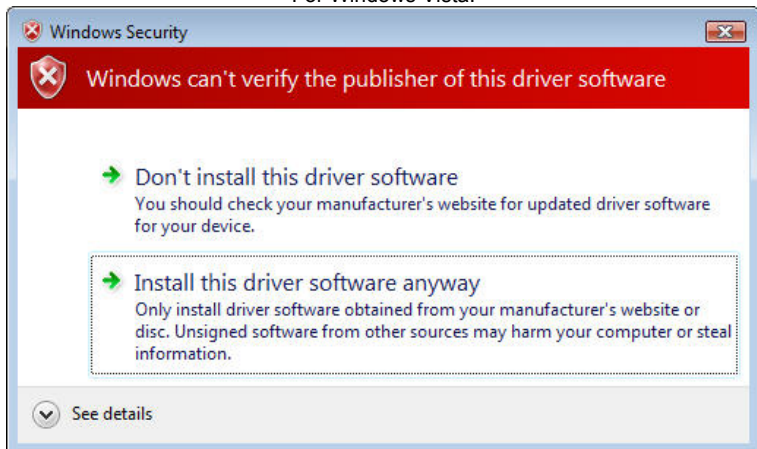

Click " Install this driver software anyway"

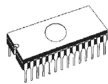

Step 9.



Click "Finish" button to finish setup.

Step 10.

For Windows Vista only:

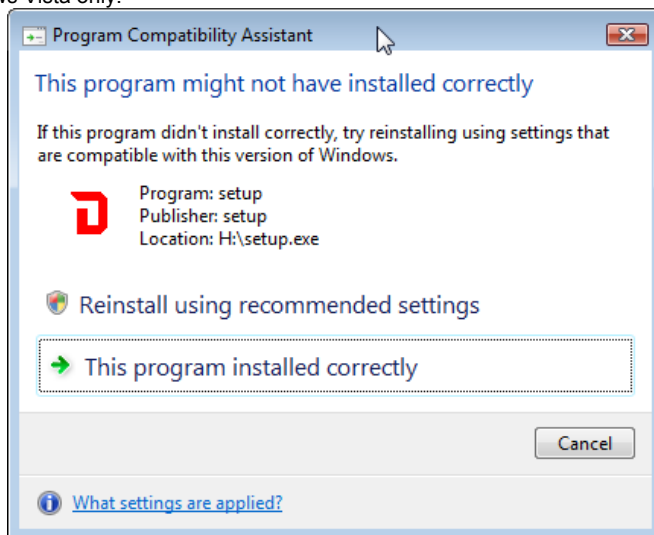

Click "This program installed correctly"

New versions of programmer software

In order to exploit all the capabilities of programmer we recommend using the latest version of Pg4uw. You may download the latest version of programmer software from our website www.dataman.com.

Copy to a temporary directory, disconnect programmer from PC and then launch it. Setup will start with **Step 2** from previous chapter.

Hardware setup

When the programmer is connected to USB port before control program was installed, Windows will detect new hardware and ask user to select driver installation method: automatically or manually. To detect programmer correctly, control program installation CD must be inserted to computer's CD-ROM drive and following steps have to be done:

Step 1.

Directly connect USB (LPT) cable to type B USB (LPT) port on programmer.

Step 2.

Directly connect USB (LPT) cable to type A USB2.0 (LPT) port on PC (high-speed recommended).

Step 3.

Connect connectors of power supply cable to appropriate connectors on programmer and wall plug.

Step 4.

Turn on programmer. At this time all 'work result' LEDs light up successive and then LEDs switch off.

For LPT connected programmer you may start work with your programmer now.

For USB connected programmer continue with next step.

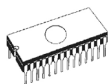

Step 5.

Windows will start with "Found new hardware wizard".

For Windows XP, Service Pack 2 users only:



Select "No, not this time" and then click on "Next" button.

For all:

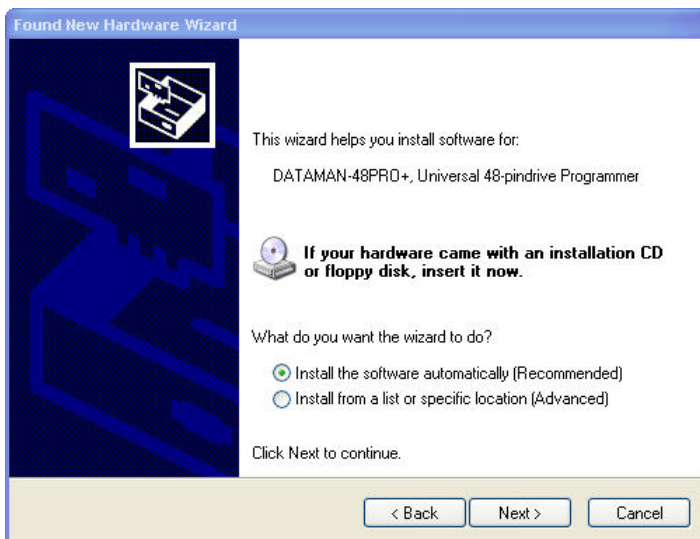

Select "Install the software automatically" and then click on "Next" button.

Step 6.

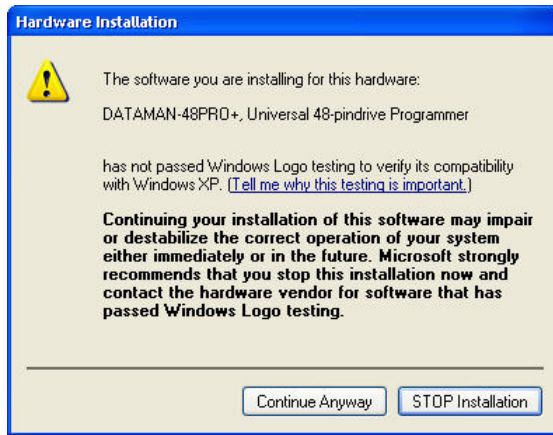

Click on "Continue Anyway" button.

For Windows Vista:

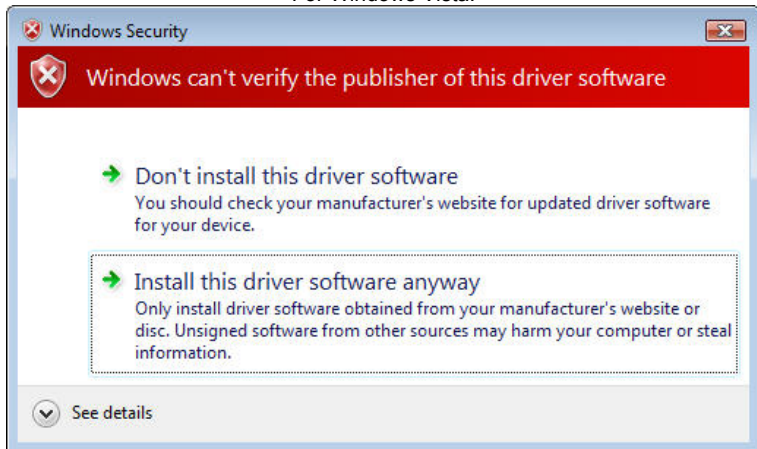

Click "Install this driver software anyway"

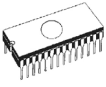

Step 7.

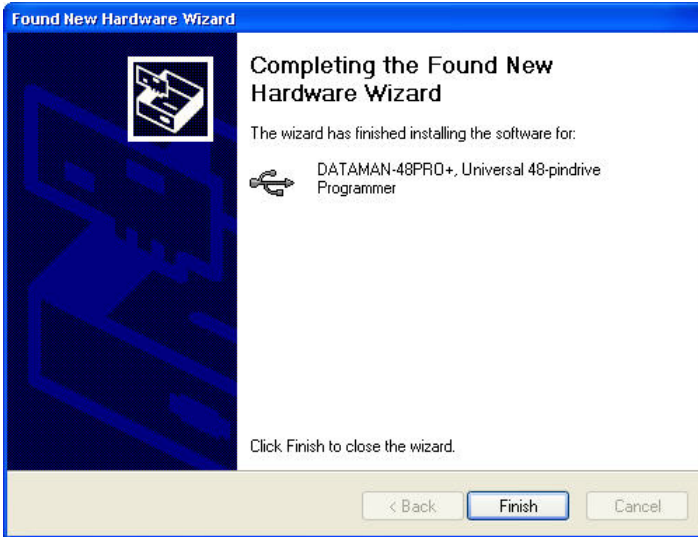

Click "Finish" button to finish setup.

Step 8.

"Found new hardware wizard" will launch for each programmer one time (for DATAMAN-448PRO2 / DATAMAN-448PRO+ 4 times). Hardware setup will be continued with Step 5.

Note: *If a different USB port on the PC is used for the next connection of programmer, "Found new hardware wizard" will launch again and install new USB drivers.*

Pg4uw



Pg4uw-the programmer software

Program Pg4uw.exe is common control program for above mentioned DATAMAN's programmers. We guarantee running of these programs under all of above mentioned operating systems without any problems.

Using the programmer software

The control program delivered by Dataman, included on the CD in your package, is granted to be free from any viruses at the moment of delivery.

Run the control program



In Windows environment: double click to icon Pg4uw.

After start, control program Pg4uw automatically scan all existing ports and search for the connected some DATAMAN's programmer. Program Pg4uw is common for all the DATAMAN's programmers, hence program try to find all supported programmers.

Notes: *When Pg4uw is started, program is checked for its integrity. Than the program display a standard user menu and waits for your instructions.*

If the control program cannot communicate with the programmer, an error message appears on the screen, including error code and description of possible reasons (disconnected programmer, bad connection, power supply failure, incompatible printer port, ...). Eliminate the error source and press any key. If error condition still exists, the program resumes its operation in the demo mode and access to the programmer is not possible. If you cannot find the cause of the error, follow the instructions in **Troubleshooting** section. In addition, the control program checks communication with programmer prior to any operation with the programmed device.

Description of the user screen

Windows program Pg4uw

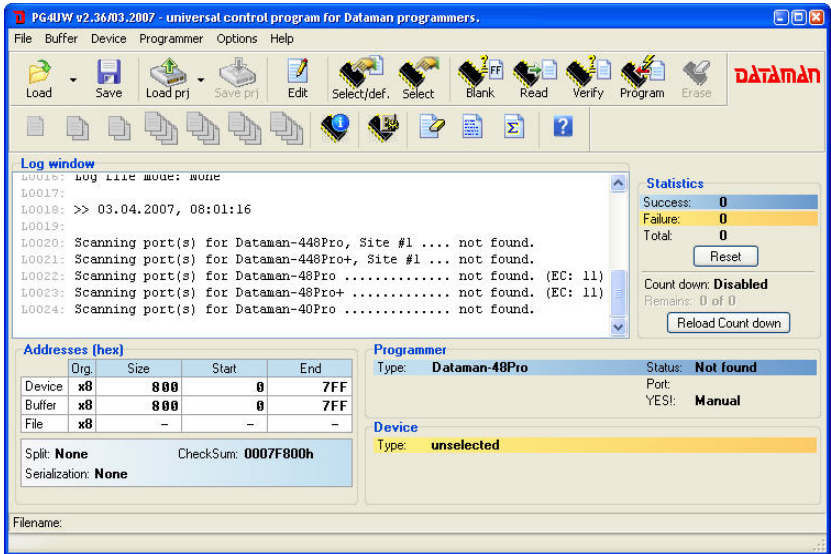

Toolbars

Under main menu are placed toolbars with button shortcuts of frequently used menu commands. Toolbars are optional and can be turned off by menu command **Options / View**.

Log window

Contains the flow-control progress information about almost every operation made in Pg4uw. Operation can be:

- starting of Pg4uw
- programmer search
- file/project load/save
- selection of device
- device operations (device read, blank check, programming, ...)
- remote control application connection and disconnection
- and other

Content of Log window can be saved to file concurrently while information is written to Log window. This option can be set by menu **Options / General options** (and tab *Log file* in dialog *General options*).

Panel Addresses

Panel Addresses contains information about actual address ranges of currently selected device, loaded file and buffer start-end address settings. Some devices allow modifying default device and buffer address ranges by menu command **Device / Device options / Operation options**.



Panel Addresses also contains some advanced information about current status of Split, Serialization and buffer checksum. For more information about each of the options, please look at:

- Split - menu Device / Device options / Operation options
- Serialization - menu Device / Device options / Serialization
- Checksum - menu Buffer / Checksum at section Checksum displayed in main window

Panel Programmer

This panel contains information about currently selected programmer.

The information includes

- programmer type
- port via programmer is connected to computer
- programmer status, can be one of following
 - Ready - programmer is connected, successfully found and ready to work
 - Not found - programmer is not found
 - Demo - when user selects option (button) Demo in dialog Find programmer
- YES! mode - some types of programmers allow to use special modes of starting next device operation in one of following ways -
 - manually by control program dialog Repeat
 - manually by button YES! placed directly on programmer
 - automatically - programmer automatically detects device removing and insertion of new device

For more details please look at **Programmer / Automatic YES!**.

Panel Device

Panel contains information about currently selected device.

The information includes

- device name (type) and manufacturer
- device adapter needed to use with currently selected programmer
- reference to detailed *Device info* dialog, available also by menu **Device / Device info**
- reference to *Advanced device options* - this is available for some types of devices only

Panel Statistics

Panel contains statistics information about currently selected device.

The information includes

- number of successful, failure and total device operations
- count-down status indicating number of remaining devices

Statistics and count-down options are available by menu command **Device / Device options / Statistics** or by mouse right click on panel *Statistics* and select item Statistics from popup menu

Panel File

The panel is placed on the bottom of Pg4uw main window. Panel shows currently loaded file or project name, size and date.

List of hot keys

<F1>	Help	Calls Help
<F2>	Save	Save file
<F3>	Load	Load a file into the buffer
<F4>	Edit	Viewing/editing of buffer
<F5>	Select/default	Target-device selection from 10 last selected devices list
<Alt+F5>	Select/manual	Target-device selection by typing device/vendor name
<F6>	Blank	Blank check
<F7>	Read	Reads device's content into the buffer
<F8>	Verify	Compares contents of the target device with the buffer
<F9>	Program	Programs target device
<Alt+Q>	Exit without save	Terminates the Pg4uw
<Alt+X>	Exit and save	Terminates the Pg4uw and saving settings too
<Ctrl+F1>		Displays additional information about current device
<Ctrl+F2>	Erase	Fill's the buffer with a given value
<Ctrl+Shift+F2>		Fill's the buffer with random values.

File

Menu **File** is used for source files manipulation, settings and viewing directory, changes drives, changes start and finish address of buffer for loading and saving files by **binary**, **MOTOROLA**, **MOS Technology**, **Intel (extended) HEX**, **Tektronix**, **ASCII space**, **JEDEC**, and **POF** format. The menu commands for loading and saving projects are located in this submenu too.

File / Load

Analyse file format and loads the data from specified file to the buffer. You can choose the format desired (**binary**, **MOTOROLA**, **MOS Technology**, **Tektronix**, **Intel (extended) HEX**, **ASCII space**, **JEDEC** and **POF**). The control program stores a last valid mask for file listing. You can save the mask into the configuration file by command **Options / Save options**.

The reserved key <F3> will bring out this menu from any menu and any time.

Note for special x16 formats:

Intel HEXx16 is Intel Hex file format with 16 bits data word for TMS320F devices.

Motorola HEXx16 is Motorola file format with 16 bits data word for TMS320F devices.

Checking the check box **Automatic file format recognition** tells program to detect file format automatically. When program can't detect file format from one of supported formats, the binary file format is assumed.

When the check box **Automatic file format recognition** is unchecked program allows user to manually select wished file format from list of available file formats on panel **Selected file format**. Default set is from **Options / General options** in panel **Load file format** at tab **File options**.

Attention: *Program doesn't know recognize files in ASCII Hex format automatically, it recognizes them as binary. So download files in ASCII Hex format with disabled option for automatic file format recognition.*



Panel Additional operation

Checking the check box **Erase buffer before loading** tells the program to erase all buffer data using entered Erase value. Buffer erase is performed immediately before reading file content to buffer and it is functional for binary and all HEX file formats. Using this one-shot setting disables current setting of **Erase buffer before loading** option in menu **Options / General options** at tab **Hex file options**.

If the checkbox **Swap bytes** is displayed, the user can activate function of swapping bytes within 16bit words (or 2-byte words) during reading of file. This feature is useful especially when loading files with Motorola representation of byte order in file (big endian). Standard load file is using little endian byte order.

Note: *Big-endian and little-endian are terms that describe the order in which a sequence of bytes are stored in computer memory. Big-endian is an order in which the "big end" (most significant value in the sequence) is stored first (at the lowest storage address). Little-endian is an order in which the "little end" (least significant value in the sequence) is stored first. For example, in a big-endian computer, the two bytes required for the hexadecimal number 4F52 would be stored as 4F52H in storage address 1000H as: 4FH is stored at storage address 1000H, and 52H will be at address 1001H. In a little-endian system, it would be stored as 524FH (52H at address 1000H, and 4FH at address 1001H).*

Number 4F52H is stored in memory:

Address	Big endian system	Little endian system
1000H	4FH	52H
1001H	52H	4FH

Panel Buffer offset for loading

Panel **Buffer offset for loading** contains one-shot offset setting for loading data from file to buffer. The setting is used to specify optional offset of loaded data to store to buffer. When Load file dialog window is opened, offset has always default setting None. It means no offset will be used to store read data in buffer.

Available offset options are:

None this setting means, no offset is applied for loading data from file to buffer.
Positive offset set of offset value, which is added to current address to store data to buffer. This offset is available for all formats and is used in x8 format, if current buffer organization is x8, or in x16 format, if current buffer organization is x16.

Negative offset mode has two options:

Negative offset and **Automatic negative offset** - set by two ways: manual or automatic.

For manual set use option Negative offset and put wished offset value to its edit box.

For automatic offset detection use option Automatic negative offset. This value is subtracted from current address for save data to buffer.

Negative offset value (manually defined or automatically detected) is subtracted from current buffer address for store data to buffer.

Negative offset is applied only for all HEX file formats and is using always x8 format. Negative offset settings are ignored for binary files and other non-HEX files.

Notes:

- *Since the value of negative offset is subtracted from real address, the result of subtraction can be negative number. Therefore take care of correct setting of this value!*
- *We recommend automatic set of negative offset in special cases only. This option contains a heuristic analyze, which can treat some data in file incorrectly. There are especially critical files, which contain a fragmented addresses range and which exceeds a size of selected device - some block can be ignored.*
- *Automatic negative offset option is not available for some kinds of special devices, that require HEX files with exactly specified blocks used for the devices - for example Microchip PICmicro devices. For these special devices, there are available only manual offset settings (None, Positive offset, Negative offset).*

Example for negative offset using:

A file contains data by Motorola S - format.

A data block started at address FFFF0H.

It is a S2 format with length of address array of 3 bytes.

For all data reading you can set Negative offset option and value of negative offset to FFFF0H.

It means that the offset will be subtracted from current real addresses and so data will be written from buffer address 0.

List of file format codes and error codes

During file download can occur some errors in some of supported formats. The error is written to LOG window in face "Warning: error #xyy in line rrr", xx is file format code, y is error code and rrr is line number in decimal.

File format codes:

- #00y - binary
- #10y - ASCII Space
- #20y - Tektronix
- #30y - Extended Tektronix
- #40y - Motorola
- #50y - MOS Technology
- #60y - Intel HEX

Load file error codes:

- #xx1 - bad first character - header
- #xx2 - bad character in current line
- #xx3 - bad CRC
- #xx4 - bad read address
- #xx5 - bad length of current line
- #xx6 - too big negative offset
- #xx7 - address is out of buffer range
- #xx8 - bad type of selected file format
- #xx9 - the file wasn't loaded all

File / Save

Command saves data in the buffer, which has been created, modified, or read from a device onto a specified disk. The file format of saved file can be chosen from supported formats list



box. There can be also entered the Buffer start and Buffer end addresses which exactly specify part of buffer to save to file. Supported file formats now are **binary**, **MOTOROLA**, **MOS Technology**, **Tektronix**, **Intel (extended) HEX**, **ASCII space**, **JEDEC** and **POF**.

If the checkbox **Swap bytes** is displayed, the user can activate function of swapping bytes within 16bit words (or 2-byte words) during writing to file. This feature is useful especially when saving files with Motorola representation of byte order in file (big endian). Standard save file operation is using little endian byte order.

The reserved key <F2> will bring out this menu from any menu and any time.

File / Load project

This option is used for loading project file, which contains device configuration buffer data saved and user interface configuration.

The standard dialog **Load project** contains additional window - **Project description** - placed at the bottom of dialog. This window is for displaying information about currently selected project file in dialog Load project.

Project information consists of:

- manufacturer and name of the first device selected in the project
- date and time of project creation
- user written description of project (it can be arbitrary text, usually author of project and some notes)

Note: for projects with serialization turned on

Serialization is read from project file by following procedure:

1. *Serialization settings from project are accepted*
2. *Additional serialization file search is performed. If the file is found it will be read and serialization settings from the additional file will be accepted. Additional serialization file is always associated to the specific project file. When additional serialization file settings are accepted, project serialization settings are ignored.*

Name of additional serialization file is derived from project file name by adding extension ".sn" to project file's name.

Additional serialization file is always placed to the directory "serialization\" into the control program's directory.

Example:

Project file name: my_work.prj

Control program's directory: c:\Program Files\Programmer

The additional serialization file will be:

c:\Program Files\Programmer\serialization\my_work.prj.sn

Additional serialization file is created and refreshed after successful device program operation. The only requirement for creating additional serialization file is load project with serialization turned on.

*Command **File / Save project** deletes additional serialization file, if the file exists, associated with currently saved project.*

File / Save project

This option is used for saving project file, which contains settings of device configuration and buffer data saved. Data saved to project file can be restored anytime by menu command **File / Load project**.

The dialog **Save project** contains three additional windows in **Project description** panel placed at the bottom of dialog **Save project**. The windows are for displaying information about currently selected project file in dialog **Save project** and information about current project, which has to be saved. Dialog **Save project** contains also additional checkboxes and button with picture of key displayed.

The first checkbox named "**Set Protected mode of software after loading of this project file**" and button with key are used to save project in special mode called Protected mode. Clicking on the button with key displayed, password dialog appears which is used to specify Protected mode password of recently saving project. Project saved with active Protected mode checkbox and password is special project also called Protected mode project. For more detailed information about Protected mode projects see **Options / Protected mode**.

The second checkbox named "**Require project file checksum before first programming**" has special function. When the checkbox is checked, program Pg4uw will ask user for entering correct project checksum before allowing starting the first device programming. The checkbox has effect after loading of project file, which was saved with the checkbox checked. Usage of the checkbox is recommended for additional check, that correct project file is recently loaded. There is also recommended to use this checkbox along with active Protected mode (the first checkbox "Set Protected mode of software after loading of this project file" checked).

Project information consists of:

- manufacturer and name of the first device selected in the project
- date and time of project creation
- user written description of project (it can be arbitrary text, usually author of project and some notes)

The first (upper) window contains information about currently selected project file in dialog Save project.

The second (middle) windows displays information about actual program configuration including currently selected device, active programmer, date, time. These actual program settings are used for creation of project description header.

The third (bottom) window is user editable and contains project description (arbitrary text), which usually consists of project author and some notes.

File / Reload file

Choose this option to reload a recently used file.

When you use a file, it is added to the **Reload file** list. Files are listed in order depending on time of use of them. Lastly used files are listed before files used far off.



To Reload a file:

1. From the File menu, choose Reload file.
2. List of lastly used files is displayed. Click the file you want to reload.

Note: *When reloading a file the file format is used, by which the file was lastly loaded/saved.*

File / Reload project

Choose this option to reload a recently used project.

When you use a project, it is added to the **Reload project** list. Projects are listed in order depending on time of use of them. Lastly used projects are listed before projects used far off.

To Reload a project:

1. From the File menu, choose Reload project.
2. List of lastly used projects is displayed. Click the project you want to reload.

File / Project options

This option is used for display/edit project options of actually loaded project. Project options means basic description of project including following project data:

- device name and manufacturer
- project creation date
- user defined project description (arbitrary text), e.g. project author and other text data for more detailed project description

User can directly edit user defined project description only. Device name, manufacturer, project date and program version are generated automatically by program.

File / Load encryption table

This command loads the data from binary file from disk and it saves them into the part of memory, reserved for an encryption (security) table.

File / Save encryption table

This command writes the content of the memory's part, reserved for an encryption table, into the file on the disk as a binary data.

File / Exit without save

The command deallocates heap, cancels buffer on disk (if exists) and returns back to the operation system.

File / Exit and save

The command deallocates heap, cancels buffer on the disk (if exists), saves current setting of recently selected devices to disk and returns back to the operation system.

Buffer

Menu **Buffer** is used for buffer manipulation, block operation, filling a part of buffer with string, erasing, checksum and of course editing and viewing with other items (find and replace string, printing...).

Buffer / View/Edit

This command is used for **view** (view mode) or **edit** (edit mode) data in buffer (for viewing in DUMP mode only). Use arrow keys for select the object for edit. Edited data are signified by color.

You can use <F4> hot key also.

View/Edit Buffer

F1	display help of actual window
F2	fill block causes filling selected block of buffer by requested hex (or ASCII) string. Sets start and end block for filling and requested hex or ASCII string.
Ctrl+F2	erase buffer with specified blank value
Ctrl+Shift+F2	fill buffer with random data
F3	copy block is used to copy specified block of data in current buffer on new address. Target address needn't be out from source block addresses.
F4	move block is used to move specified block of data in current buffer on new address. Target address needn't be out from source block addresses. Source address block (or part) will be filled by topical blank character.
F5	swap bytes command swaps a high- and low- order of byte pairs in current buffer block. This block must start on even address and must have an even number of bytes. If these conditions do not fulfil, the program modifies addresses itself (start address is moved on lower even address and/or end address is moved on higher odd address).
F6	print buffer
F7	find string (max. length 16 ASCII characters)
F8	find and replace string (max. 16 ASCII chars.)
F9	change current address
F10	change mode view / edit
F11	switch the mode of buffer data view between 8 bit and 16 bit view. It can be also doing by mouse clicking on the button to the right of View/Edit mode buffer indicator. This button indicates actual data view mode (8 bit or 16 bit), too.
F12	checksum dialog allows to count checksum of selected block of buffer change mode view / edit
Arrow keys	move cursor up, down, right and left
Home/End	jump on start / end current line
PgUp/PgDn	jump on previous / next page
Ctrl+PgUp/PgDn	jump on start / end current page
Ctrl+Home/End	jump on start / end current device
Shift+Home/End	jump on start / end current buffer
Backspace	move cursor one position left (back)

Note: characters 20H - FFH (mode ASCII) and numbers 0..9, A..F (mode HEX) immediately changes content of edit area.



Warning: *Editing of ASCII characters for word devices is disabled.*

Print buffer

This command allows write selected part of buffer to printer or to file. Program uses at it an external text editor in which selected block of buffer is displayed and can be printed or saved to file, too. By default is set simple text editor **Notepad.exe**, which is standard part of all versions of Windows.

In Print buffer dialog are following options:

Block start

Defines start address of selected block in buffer.

Block end

Defines end address of selected block in buffer.

External editor

This item defines path and name of external program, which has to be used as text viewer for selected block of buffer. By default is set simple text editor Notepad.exe, which is standard part of all versions of Windows. User can define any text editor for example Wordpad.exe, which is able to work with large text files. In user defined text editor user can print or save to file selected block of buffer.

The external editor path and name is saved automatically to disk.

Find dialog box

Enter the search string to **Find** to text input box and choose **<Find>** to begin the search or choose **<Cancel>** to forget it.

Direction box specifies which way you want to search, starting from the current cursor position (In edit mode). **Forward** (from the current position or start of buffer to the end of the buffer) is the default. **Backward** searches toward the beginning. In view mode searches all buffer.

Origin specifies where the search should start.

Find & Replace dialog box

Enter the search string in the **Text to find** string input box and enter the replacement string in the **Replace with** input box.

In **Options** box you can select prompt on replace: if program finds instance you will be asked before program change it.

Origin specifies where the search should start.

Direction box specifies which way you want to search, starting from the current cursor position (In edit mode). **Forward** (from the current position or start of buffer to the end of the buffer) is the default. **Backward** searches toward the beginning. In view mode searches all buffer.

Press **<Esc>** or click **Cancel** button to close dialog window.

By pressing **Replace** button the dialog box is closed and a Question window is displayed. This window contains following choices:

Yes replaces found item and finds next

No finds next item without replacing current one

Replace All replaces all found items
Abort search aborts this command

View/Edit buffer for PLD

Ctrl+F2 erase buffer with specified blank value
Ctrl+Shift+F2 fill buffer with random data
F9 go to address...
F10 change mode view / edit
F11 switch the mode of buffer data view between 1 bit and 8 bit view. It can be also doing by mouse clicking on the button to the right of View/Edit mode buffer indicator. This button indicates actual data view mode (1 bit or 8 bit), too.

Arrow keys move cursor up, down, right and left
Home/End jump on start / end current line
PgUp/PgDn jump on previous / next page
Ctrl+PgUp/PgDn jump on start / end current page
Ctrl+Home/End jump on start / end edit area
Backspace move cursor one position left (back)

Note: Characters 0 and 1 immediately changes content of edit area.

Buffer / Fill block

Selecting this command causes filling selected block of buffer by requested hex (or ASCII) string. Sets start and end block for filling and requested hex or ASCII string.

Buffer / Copy block

This command is used to copy specified block of data in current buffer on new address. Target address needn't be out from source block addresses.

Buffer / Move block

This command is used to move specified block of data in current buffer on new address. Target address needn't be out from source block addresses. Source address block (or part) will be filled by topical blank character.

Buffer / Swap block

This command swaps a high- and low- order of byte pairs, foursomes or nibbles inside bytes depending on swap mode selected by user. Swap operation is performed on buffer block specified by Start and End addresses. This block must start on even address and must have an even number of bytes. If the conditions do not fulfill, the program modifies addresses itself (start address is moved on lower even address and/or end address is moved on higher odd address).

Following swap modes are available, user can select from:

1. Swap 2-bytes inside 16-bit words swap of byte pairs inside 16-bit words.
2. Swap 4-bytes inside 32-bit words swap of byte foursomes inside 32-bit words.
3. Swap nibbles inside bytes swap of high- and low- nibbles inside each byte.

Examples of swap operation in buffer:

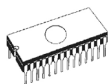

Swap bytes operation from Start address 0 to End address N modifies data in buffer by following tables:

Address	Original Data	Swap 2-bytes inside 16-bit words	Swap 4-bytes inside 32-bit words	Swap nibbles inside bytes
0000h	b0	b1	b3	b0m
0001h	b1	b0	b2	b1m
0002h	b2	b3	b1	b2m
0003h	b3	b2	b0	b3m
0004h	b4	b5	b7	b4m
0005h	b5	b4	b6	b5m
0006h	b6	b7	b5	b6m
0007h	b7	b6	b4	b7m

b0, b1, b2, ... means original buffer byte values from addresses 0, 1, 2, ...

b0m, b1m, b2m, ... means nibble-swapped original bytes b0, b1, b2, ... by following rules:

Original Byte bits	bit 7	bit 6	bit 5	bit 4	bit 3	bit 2	bit 1	bit 0
Nibble-swapped Byte Bits	bit 3	bit 2	bit 1	bit 0	bit 7	bit 6	bit 5	bit 4

Buffer / Erase

If this command is selected, the content of the buffer will be filled with topical blank character.

The reserved key <Ctrl+F2> will bring out this menu from any menu and any time.

Buffer / Fill random data

If this command is selected, the content of the buffer will be filled with random data.

The reserved key <Shift+Ctrl+F2> will bring out this menu from any menu and any time.

Buffer / Duplicate buffer

This command performs duplicate buffer content in range of source EPROM to range of destination EPROM. This procedure is suitable if there is used for example 27C512 EPROM to 27C256 EPROM position.

Note: *The procedure always uses buffer start address 00000h.*

Buffer / Checksum

Checksum of data stored in buffer of Pg4uw is useful to check the data are correct.

Pg4uw contains following functions according to checksum:

- **Automatic checksum calculator** with **Main checksum** value displayed in main window of Pg4uw in table **Addresses** and in **Log window** of Pg4uw
- **On-demand checksum calculator** that can calculate and display various types of checksums of various data blocks in buffer.

Settings for Automatic checksum calculator and on-demand checksum calculator are available in dialog **Checksum**.

Dialog **Checksum** contains two tabs (panels):

- **Tab Main checksum options**

- **Tab Checksum calculator**

Tab Main checksum options allows setting mode of **Automatic checksum calculator**. It contains following controls:

- Checkbox **Apply user-defined buffer addresses for main checksum**
 - unchecked status global Buffer start and Buffer end address is used for calculating checksum of buffer data
 - checked status user defined addresses are used to calculate checksum of buffer data
- Fields **From address** and **To address** are used to enter address range for main checksum calculation. Addresses are used only when checkbox **Apply user-defined buffer addresses for main checksum** is checked.
- Selection group **Checksum type** allows selecting wished kind of checksum to be used for main checksum. More information about **Main checksum** types can be found below.
- Field **Checksum** contains actual value of recently calculated checksum
- Button **Apply** is used to confirm checksum settings from Main checksum options. Please note, that once the button is pressed, previous checksum settings are lost.
- Button **Close** is used to close the Checksum dialog.
- Group **Exclude buffer data for checksum** contains options for specifying blocks of buffer data, which have to be excluded from checksum calculation. This is useful for example for serialization. Serialization modifies data at specified addresses in buffer. So there is problem to check the checksum of buffer, when data on some addresses are changed by serialization engine before programming of each device. If part of buffer used for serialization is excluded from checksum calculation, the checksum of buffer data will not be changed by serialization data changes. One or more excluded blocks can be specified.

Tab Checksum calculator contains on-demand checksum calculator. It contains following controls:

- **From address** This is a start address of block selected for calculating checksums in buffer. Address is always defined as Byte address.
- **To address** This is an end address of block selected for calculating checksums in buffer. Address is always defined as Byte address.
- Fields displaying values of calculated checksum types:
 - BYTE** sum by bytes to DWORD. CY flag is ignored.
 - WORD** sum by words to DWORD. CY flag is ignored.
 - BYTE (CY)** sum by bytes to DWORD. CY flag is added to result.
 - WORD (CY)** sum by words to DWORD. CY flag is added to result.
 - CRC-CCITT** sum by bytes to Word using $RESULT=PREVIOUS + (x^{16} + x^{12} + x^5 + 1)$
 - CRC-XMODEM** sum by bytes to Word using $RESULT=PREVIOUS + (x^{16} + x^{15} + x^2 + 1)$
 - CRC-32** sum by bytes to DWORD using standard CRC-32 algorithm
- Column marked as **NEG.** is a negation of checksum so, that $SUM + NEG. = FFFFH$.
- Column marked as **SUPPL.** is complement of checksum so, that $SUM + SUPPL. = 0$ (+ carry).
- **Word** is 16-bit word. **DWORD** is 32-bit word.

Supported hash sums:

MD5 an MD5 hash expressed as a sequence of 32 hexadecimal digits (128 bits)



SHA-1 "Secure Hash Standard" expressed as a sequence of 40 hexadecimal digits (160 bits)

- **Insert checksum options** box.
This box contains following options for **Calculate & insert** operation:
- **Insert checksum**
Kind of checksum that is written into the buffer when, the **Calculate & insert** operation was executed.
- **Insert address**
Address in buffer where a result of chosen checksum is written, when the **Calculate & insert** was executed. Address can not be specified inside the range **<From address>** to **<To address>**. Address is always defined as Byte address.
- **Size**
Size of chosen checksum result, which will be written into the buffer. A size of inserted checksum may be **Byte** (8-bit), **Word** (16-bit) or **DWORD** (32-bit). If size is smaller then selected checksum size, only lower byte(s) of checksum value will be written into the buffer.
Note: If Word size was selected, a low byte of checksum value will be written on address specified in box Insert address and a high byte will be written on address incremented by one. Similarly it is for DWORD.
- **Byte order mode for Word and Word (CY) checksums** box
This box contains setting of byte orientation in words summed for Word and Word (CY) checksums.
Available settings are **Little endian** and **Big Endian**. Description of both settings is in section **Word sum Little Endian (x16)** and **Word sum Big Endian (x16)** of **Automatic checksum calculator** help (above).
- **Calculate** button
Click on the button Calculate starts calculating checksums for selected block in buffer. No writes into the buffer are executed.
- **Calculate & insert** button
Click on the button Calculate & insert starts calculating checksums for selected block in the buffer and writes the chosen checksum into the buffer on address specified by Insert address. This function is available for Byte, Word, CRC-CCITT and CRC-XMODEM checksums.
- **Close** button
Closes dialog Checksum.

Main checksum types

Checksum value displayed in main program window in table "Addresses" shows sum of current data in main buffer. Sum is calculated with following rules:

- Address range of data block the checksum is calculated, can be set to one of two modes:
 - Default addresses "Buffer Start" and "Buffer End", that are displayed in table "Addresses" in the main program window.
 - Custom defined addresses.
The settings are available in dialog **Checksum**, tab Main checksum options, check box **Use custom defined buffer addresses for checksum calculation**. Custom checksum address mode is indicated as [addrfrom..addrto] string displayed after checksum value in main program window in table "Addresses".

Checksum address range settings are associated to currently selected device only. After new device is selected, address range is set to default addresses mode "Buffer Start" and "Buffer End" for selected device. Checksum address mode is also saved to project files.

- Following checksum types are available for Main checksum:

Byte sum (x8)

Buffer data are summed byte-by-byte irrespective of current buffer view mode (x8/x16/x1) organization. Any carry bits exceeding 32-bits are neglected. This checksum mode is indicated by string (x8) displayed after checksum value in main program window.

Word sum Little Endian (x16)

Buffer data are summed word-by-word irrespective of current buffer view mode organization. Any carry bits exceeding 32-bits are neglected. This checksum mode is indicated by string (x16 LE) displayed after checksum value in main program window. Term Little Endian means, the buffer checksum is calculated from words read from buffer in Little Endian mode.

Word sum Big Endian (x16)

Buffer data are summed word-by-word irrespective of current buffer view mode organization. Any carry bits exceeding 32-bits are neglected. This checksum mode is indicated by string (x16 BE) displayed after checksum value in main program window. Term Big Endian means, the buffer checksum is calculated from words read from buffer in Big Endian mode.

CRC-CCITT

Buffer data are summed by bytes to 16-bit word using standard CRC-CCITT algorithm
 $RESULT = PREVIOUS + (x^{16} + x^{12} + x^5 + 1)$

CRC-XMODEM

Buffer data are summed by bytes to 16-bit word using standard CRC-XMODEM algorithm
 $RESULT = PREVIOUS + (x^{16} + x^{15} + x^2 + 1)$

CRC-32

Buffer data are summed by bytes to 32-bit word using standard CRC-32 algorithm.

MD5 and SHA-1

Support for hash-sum types will be coming soon.

The checksum modes can be set in pop-up menu by clicking on label checksum in main program window or by menu shortcuts **Shift+Ctrl+1** for Byte sum (x8), **Shift+Ctrl+2** for Word sum Little Endian (x16) or **Shift+Ctrl+3** for Word sum Big Endian (x16) etc..

Options are also available in dialog **Checksum**, tab **Main checksum options**.

Checksum type is saved to configuration file and project file. Setting from project file has higher precedence.

Device

Menu **Device** includes functions for a work with selected programmable devices - device select, read data from device, device blank check, device program, device verify and device erase.

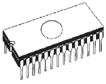

Device / Select from default devices

This window allows selecting the desired type of the device from list of default devices. This one is a cyclic buffer in which are stored recently selected devices including their device options. This list is saved to disk by command **File / Exit and save**.

If you wish display additional information about the current device, use an **<Ctrl+F1>** key. This command provides a size of device, organization, programming algorithm and a list of programmers (including auxiliary modules) that supported this device. You can find here package information and other general information about current device too.

Use a **** key for delete of current device from list of default devices. There isn't possible to empty this list, if you repeat this access. The last device stays in buffer and the **** key isn't accepted.

Device / Select device ...

This window allows selecting the desired type of the device from all devices supported by current programmer. It is possible to choose device by **name**, by **type** or by **manufacturer**.

Note 1: *The names of the programmable devices in software don't contain all characters, shown at the top of the chip or mentioned in the datasheet section part numbering. The names contain all characters necessary to identification of the device, but don't contain such codes, that have none influence to the programming, for example temperature code, speed code, packing type code, etc.. If such code letter is at the end of the name, is omitted, if such code letter is in the middle of name, then is replaced by character 'x'.*

Examples:

- Devices Am27C512-150, Am27C512-200 and Am27C512-250 are shown in the software only once, as Am27C512
- S29GL064N11TF1010 device is shown in the software as S29GL064NxxTxx01

Note 2: *If some device is listed twice and the second time with suffix x16, it means, that programming algorithm provides faster word mode.*

Selected device is automatically saved to buffer of default devices. This buffer is accessible with **Device / Select from default devices** command.

In the **Search mask** field you can enter mask for filtering of whole device list by device name, manufacturer and/or programming adapter names. The space as delimiter of filter items (fragments) has "OR" function. If you want to enter exact filter string including spaces, use quotation mark character ".

Example:

We need to see the devices that need no adapter, and we know that such devices have following note string in **Adapter** column of device list: *Note: in ZIF socket of programmer*. The suitable filter to show only wished devices is "in ZIF" (including quotation marks). The filter strings are not case sensitive, i.e. for example "ZIF" is the same as "zif".

If you wish display additional information about the current device, use button **Device info** or an **<Ctrl+F1>** key. This command provides a size of device, organization, programming

algorithm and a list of programmers (including auxiliary modules) that supported this device. You can find here package information and other general information about current device too.

The currently displayed device list can be saved to text file by pressing button **Save currently displayed list to file**.

Select device ... / All

This window allows selecting the desired type of the device from all devices supported by current programmer. Supported devices are displayed in a list box.

Device can be select by double click on a line from list with desired manufacturer name and device number or by entering manufacturer name and/or device number in a search box (use a key **<Space>** as a separation character) and press **<Enter>** or click **OK** button.

Press a key **<Esc>** or click **Cancel** button at any time to cancel device selection without affecting the currently selected device.

Selected device is automatically saved to buffer of default devices. This buffer is accessible with **Device / Select from default devices** command.

If you wish display additional information about the current device, use button **Device info** or an **<Ctrl+F1>** key. This command provides a size of device, organization, programming algorithm and a list of programmers (including auxiliary modules), which supported this device. You can find here package information and other general information about current device too.

Select device ... / Only selected type

This window allows selecting the desired type of the device. At the first - you must select a device type (e.g. EPROM) and device subtype (e.g. 64Kx8 (27512)), using mouse or cursor keys. It will cause a list of manufacturers and devices will be displayed.

Device can be select by double click on a line from list with desired manufacturer name and device number or by entering manufacturer name and/or device number in a search box (use a key **<Space>** as a separation character) and press **<Enter>** or click **OK** button.

Press a key **<Esc>** or click **Cancel** button at any time to cancel device selection without affecting the currently selected device.

Selected device is automatically saved to buffer of default devices. This buffer is accessible with **Device / Select from default devices** command.

If you wish display additional information about the current device, use button **Device info** or an **<Ctrl+F1>** key. This command provides a size of device, organization, programming algorithm and a list of programmers (including auxiliary modules) that supported this device. You can find here package information and other general information about current device too.

Select device ... / Only selected manufacturer

This window allows selecting the desired device type by manufacturer. First select a required manufacturer in Manufacturer box using mouse or cursor keys. It will cause a list of selected manufacturer devices will be displayed.

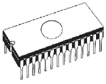

Device can be select by double click on a line from list with desired manufacturer name and device number or by entering device number in a search box (use a key **<Space>** as a separation character) and press **<Enter>** or click **OK** button.

Press a key **<Esc>** or click **Cancel** button at any time to cancel device selection without affecting the currently selected device.

Selected device is automatically saved to buffer of default devices. This buffer is accessible with **Device / Select from default devices** command.

If you wish display additional information about the current device, use button **Device info** or an **<Ctrl+F1>** key. This command provides a size of device, organization, programming algorithm and a list of programmers (including auxiliary modules) that supported this device. You can find here package information and other general information about current device too.

Device / Select EPROM /Flash by ID

Use this command for autoselect an EPROM or Flash as active device by reading the device ID. The programmer can automatically identify certain devices by the reading the manufacturer and the device-ID that are burnt into the chip. This only applies to EPROM or Flash that supports this feature. If the device does not support a chip ID and manufacturer's ID, a message will be displayed indicating this as an unknown or not supported device.

If more devices with identical chip ID and manufacturer's ID were detected, the list of these devices will be displayed. A corresponding device can be chosen from this list by selecting its number (or manufacturer name) from list and press **<Enter>** (or click **OK** button). Press a key **<Esc>** or click **Cancel** button at any time to cancel device selection without affecting the currently selected device.

Warning: *The control program only support this time EPROM's and Flash with 28 and 32 pins. Any of programmers determines pins number automatically. For other programmers you must enter this number manually.*

The programmer applies a high voltage to the appropriate pins on the socket. This is necessary to enable the system to read the device ID. Do not insert into the socket a device that is not an EPROM or Flash. It may be damaged when the programmer applies the high voltage.

We don't recommend apply this command to 2764 and 27128 EPROM types, because most of them ID not supports.

Device / Device options

All settings of this menu are used for programming process, serialization and associated file control.

Device / Device options / Operation options

All settings of this command are used for programming process control. This is a flexible environment, which content items associated with current device and programmer type. Items, which are valid for the current device but aren't supported by current programmer, are disabled. These settings are saving to disk along with associated device by **File / Exit and save** command.

The commonly used terms are also explained in the user's manual to programmer. The special terms used here are exactly the terms used by manufacturer of respective chip. Please read the documentation to the chip you want to program for explanation of all used terms.

List of commonly used items:

group **Addresses:**

device start address (default 0)
 device end address (default device size-1)
 buffer start address (default 0)

Split (default none)

This option allows setting special mode of buffer when programming or reading device. Using split options is particularly useful when using 8-bit data memory devices in 16-bit or 32-bit applications.

Following table describes buffer to device and device to buffer data transfer

Split type	Device	Buffer Address assignment
None	Device[ADDR]	Buffer[ADDR]
Even	Device[ADDR]	Buffer[2*ADDR]
Odd	Device[ADDR]	Buffer[1+(2*ADDR)]
1./4	Device[ADDR]	Buffer[4*ADDR]
2./4	Device[ADDR]	Buffer[1+(4*ADDR)]
3./4	Device[ADDR]	Buffer[2+(4*ADDR)]
4./4	Device[ADDR]	Buffer[3+(4*ADDR)]

Real addressing will be following: (all addresses are hexadecimal)

Split type	Device addresses	Buffer addresses
None	00 01 02 03 04 05	00 01 02 03 04 05
Even	00 01 02 03 04 05	00 02 04 06 08 0A
Odd	00 01 02 03 04 05	01 03 05 07 09 0B
1./4	00 01 02 03 04 05	00 04 08 0C 10 14
2./4	00 01 02 03 04 05	01 05 09 0D 11 15
3./4	00 01 02 03 04 05	02 06 0A 0E 12 16
4./4	00 01 02 03 04 05	03 07 0B 0F 13 17

Terms explanation:

Access to device address ADDR is written as Device[ADDR].

Access to buffer address ADDR is written as Buffer[ADDR].

ADDR value can be from zero to device size (in bytes).

All addresses are byte oriented addresses.

group **Insertion test:**

insertion test (default ENABLE)

If enabled, the programmer checks all pins of the programmed chip, if have proper connection to the ZIF socket (continuity test). The programmer is able to identify the wrong contact, misinserted chip and also (partially) backinserted chip.

Device ID check error terminates the operation (default ENABLE)

Programmer provides ID check before each selected action. It compares read ID codes from device with ID codes defined by device manufacturer. In case of ID error, control program behaves as follows:



- if item is set to ENABLE, selected action is finished
- if item is set to DISABLE, selected action continues. Control program just writes warning message about ID error to LOG window.

If enabled, the programmer checks the electronic ID of the programmed chip.

Note 1: *Some old chips don't carry electronic ID.*

Note 2: *In some special cases, several microcontrollers don't provide ID, if copy protection feature in the chip is set, even if device ID check setting in control program is set to "Enable".*

group **Command execution:**

blank check before programming	(default DISABLE)
erase before programming	(default DISABLE)
verify after reading	(default ENABLE)
verify	(ONCE, TWICE)
verify options	(nominal VCC +/-5% nominal VCC +/-10% VCCmin - VCCmax)

group **Target system power supply parameters**

This group is available in ISP mode for some types of devices. It contains following settings:

Enable target system power supply - enables supplying of target system from programmer. Supply voltage for target system is switched on before action with programmed device and is switched off after action finished. If Keep ISP signals at defined level after operation is enabled, then programmer will switch off supply voltage after pull-up/pull-down resistors are deactivated.

Voltage - supply voltage for target system. Supply voltage range is from 2V to 6V.

Note: *The voltage value given to target system depends also on current flowing to target system. To reach exact voltage supply for target system, the proper Voltage and Max. current values has to be defined. The Max. current value specified has to be as exact as possible equal to real current consumption of target system.*

Max. current - maximum current consumption of powered target system. Current consumption range is from 0 to 300mA

Voltage rise time - determines skew rate of rising edge of target system power supply voltage (switch on supply voltage).

Target supply settle time - determines time, after which must be supply voltage in target system stabilized at set value and target system is ready to any action with programmed device.

Voltage fall time - determines skew rate of falling edge of target system power supply voltage (switch off supply voltage).

Power down time - determines time after switch off target system power supply within target system keeps residual supply voltage (e.g. from charged capacitor). After this time elapsed target system has to be without supply voltage and can be safely disconnected from programmer.

group **Target system parameters**

This group is available in ISP mode for some types of devices. It contains following settings:
Oscillator frequency (in Hz) - oscillator's frequency of device (in target system). Control program sets programming speed by its, therefore is necessary set correct value.

Supply voltage (in mV) - supply voltage in target system. Control program checks or sets (it depends on programmer type) entered supply voltage in target system before every action on device.

Disable test supply voltage - disables measure and checking supply voltage of programmed device, set in Supply voltage edit box, before action with device.

Delay after reset active - this parameter determine delay after Reset signal active to start action with device. This delay depends on values of used devices in reset circuit of device and can be chosen from these values: 10ms, 50ms, 100ms, 500ms or 1s.

Inactive level of ISP signals - this parameter determine level of ISP signals after finishing access to target device. Signals of ISP connector can be set to Pull-up (signals are tied through 22k resistors to supply voltage) or Pull-down (signals are tied through 22k resistors to ground).

Keep ISP signals at defined level after operation - enables keeping set level of ISP signals after access to target device finished. Control program indicates activated pull-up/pull-down resistors by displaying window with warning. After user close this window control program will deactivate resistors.

group **Programming parameters**

This group is available for some types of devices. It contains settings of which device parts or areas have to be programmed.

group **Erase parameters**

This group is available for some types of devices. It contains special settings of erase modes of selected device.

Device / Device options / Serialization

Serialization is special mode of program. When a serialization mode is activated, a specified value is automatically inserted on predefined address into buffer before programming each device. When more devices are programmed one by one, the serial number value is changed for each device automatically and inserted into buffer before programming device, so each device has unique serial number.

There are two types of serialization:

- Incremental mode
- From file mode
- Custom generator mode



Dialog **Serialization** contains also settings for associated serialization position files that are used with project files with serialization turned on. For more detailed information about using serialization in project files, look at **Serialization and projects**.

Basic rules of serialization:

If a new device is selected, the serialization function is set to a default state i.e. disabled. Actual serialization settings for actually selected device are saving to disk along with associated device by **File / Exit and save** command.

When incremental mode is active following actual settings are saved to configuration file: address, size, serial value, incremental step and settings of modes ASCII / BIN, DEC / HEX, LS byte / MS Byte first.

When from-file mode is active following actual settings are saved to configuration file: name of input serialization file and actual label, which indicates the line with actual serial number in input file.

When program is in multiprogramming mode (multiple socket programmer is actually selected) the special section - **Action on not programmed serial values due to error** - is displayed in dialog **Serialization**. In this section two choices are available:

- Ignore not programmed serial values
- Add not programmed serial values to file

Ignore not programmed serial values means the not programmed serial values are ignored and no action is done with them.

Add not programmed serial values to file means the not programmed serial values are added to file. The file of not programmed serial values has the same text format as serialization file for "From-file" serialization mode. So there is possible to program the serial values later on by "From-file" serialization mode.

Notes: *If device programming is stopped by user, program will not change the serial values ready for next batch of devices. The same situation is if device program is incomplete, e.g. for device insertion test error.*

Ignoring or writing not programmed serial values is only used when at least one device from current batch of devices in multiple socket module programmer is completely programmed and verified without errors.

Serialization can work with control program's main buffer or extended buffers available for some types of devices, for example Microchip PIC16Fxxx devices with Data EEPROM Memory. The selection which buffer has to use by serialization routine is available in dialog **Serialization**. The extended buffer selection is ignored for From-file serialization in playlist file mode. For more details about this limitation, see the **From file mode** serialization mode description please.

If you wish to exclude serialization data from main checksum automatic calculation, you can use **Exclude buffer data for checksum** feature available in dialog **Checksum** in tab **Main checksum options**.

Device / Device options / Serialization / Incremental mode

The Incremental mode enables to assign individual serial numbers to each programmed device. A starting number entered by user will be incremented by specified step for each

device program operation and loaded in selected format to specified buffer address prior to programming of each device.

There are following options, that user can modify for incremental mode:

S / N size

S / N size option defines the number of bytes of serial value which will be written to buffer. For Bin (binary) serialization modes values 1-8 are valid for S / N size and for ASCII serialization modes values 1-16 are valid for S / N size.

Address

Address option specifies the buffer address, where serial value has to be written. Note that address range must be inside the device start and device end addresses. Address must be correctly specified so the last (highest or lowest) byte of serial value must be inside device start and device end address range.

Start value

Start value option specifies the initial value, from which serialization will start. Generally, the max. value for serialization is \$1FFFFFFF in 32 bit long word.

When the actual serial value exceeds maximum value, three most significant bits of serial number are set to zero. After this action the number is always inside 0..\$1FFFFFFF interval (this is basic style of overflow handling).

Step

Step options specify the increment step of serial value incrementation.

S / N mode

S / N mode option defines the form in which serial value has to be written to buffer. Two options are available:

- ASCII
- Bin

ASCII - means the serial number is written to buffer as ASCII string. For example number \$0528CD is in ASCII mode written to buffer as 30h 35h 32h 38h 43h 44h ('0' '5' '2' '8' 'C' 'D'), i.e. six bytes.

Bin - means the serial number is written directly to buffer. If the serial number has more than one byte length, it can be written in one of two possible byte orders. The byte order can be changed in „Save to buffer“ item.

Style

Style option defines serial number base. There are two options:

- Decimal
- Hexadecimal.

Decimal numbers are entered and displayed using the characters '0' through '9'.

Hexadecimal numbers also use characters 'A' through 'F'.

The special case is Binary Dec, which means BCD number style. BCD means the decimal number is stored in hexadecimal number, i.e. each nibble must have value from 0 to 9. Values A to F are not allowed as nibbles of BCD numbers.

Select the base in „Style“ options before entering numbers of serial start value and step.

Save to buffer



Save to buffer option specifies the serial value byte order to write to buffer. This option is used for Bin S / N mode (for ASCII mode it has no effect).

Two options are available:

- *LSByte first* (used by Intel processors) will place the Least Significant Byte of serial number to the lowest address in buffer.
- *MSByte first* (used by Motorola processors) will place the Most Significant Byte first to the lowest address in buffer.

Split serial number at every N byte(s)

The option allows dividing serial number into individual bytes and placing the bytes at each Nth address of buffer. This feature is particularly useful for example for Microchip PIC devices when the device serial number can be the part of program memory as group of RETLW instructions. The example of using serial number split is listed in section Examples below as example number 2.

Example:

Example 1:

Write serial numbers to AT29C040 devices at address 7FFF00H, size of serial number is 4 bytes, start value is 16000000H, incremental step is 1, the serial number form is binary and least significant byte is placed at the lower address of serial number in device.

To make above described serialization following settings have to be set in Serialization dialog:

Mode: Incremental mode
S/N size: 4 bytes
S/N mode:: Bin
Style: Hex
Save to buffer: LS Byte first
Address: 7FFF00H
Start value: 16000000H
Step: 1

Following values will be written to device:

The 1st device

Address	Data
007FFF0	xx xx xx xx xx xx xx xx xx xx xx xx 00 00 00 16

The 2nd device

Address	Data
007FFF0	xx xx xx xx xx xx xx xx xx xx xx xx 01 00 00 16

The 3rd device

Address	Data
007FFF0	xx xx xx xx xx xx xx xx xx xx xx xx 02 00 00 16

etc.

"xx" mean user data programmed to device

Serial numbers are written to device from address 7FFF00H to address 7FFFFFH because serial number size is 4 bytes.

Example 2:

Following example shows usage of SQTP serialization mode when serial number is split into RETLW instructions for Microchip PIC16F628 devices.

Note: Serial quick turn programming (SQTP) is Microchip specified standard for serial programming of Microchip PIC microcontrollers. Microchip PIC devices allows you to program a unique serial number into each microcontroller. This number can be used as an entry code, password, or ID number.

Serialization is done by using a series of RETLW (Return Literal W) instructions, with the serial number bytes as the literal data. To serialize, you can use Incremental mode serialization or From file mode serialization.

Incremental serialization offers serial number Split function. Serial number split allows usage of incremental numbers separated into even or odd bytes and between each byte of serial number RETLW instruction code is inserted.

From file serialization is using proprietary serial numbers file. This file can consist of various serial numbers. The numbers can have format suitable for SQTP that means number RETLW b1 RETLW b2 and so on. Note that Pg4uw serial file format is not compatible with SQTP serial file generated by Microchip MPLAB.

Device PIC16F628 has 14 bit wide instruction word. Instruction RETLW has 14-Bit Opcode:

Description		MSB	14-Bit word	LSB
RETLW	Return with literal in W	11	01xx kkkk	kkkk

where xx can be replaced by 00 and k are data bits, i.e. serial number byte

Opcode of RETLW instruction is hexadecimal 34KKH where KK is data Byte (serial number byte)

Let's assume we want to write serial number 1234ABCDH as part of four RETLW instructions to device PIC. The highest Byte of serial number is the most significant Byte. We want to write the serial number to device program memory at address 40H. Serial number split us very useful in this situation. Serialization without serial number split will write the following number to buffer and device:

Address	Data
0000080	CD AB 34 12 xx xx xx xx xx xx xx xx xx xx

Note: address 80H is because buffer has byte organization and PIC has word organization so it has equivalent program memory address 40H. When buffer has word organization x16, the address will be 40H and number 1234ABCDH will be placed to buffer as following:

Address	Data
0000040	ABCD 1234 xxxx xxxx xxxx xxxx xxxx xxxx

We want to use RETLW instruction so buffer has to be:

Address	Data
0000040	34CD 34AB 3434 3412 xxxx xxxx xxxx xxxx

We can do this by following steps:



A) write four RETLW instructions at address 40H to main buffer (this can be done by hand editing buffer or by loading file with proper content). The bottom 8 bits of each RETLW instruction are not important now, because serialization will write correct serial number bytes at bottom 8 bits of each RETLW instruction.

The buffer content before starting device program will look for example as following:

Address	Data
0000040	3400 3400 3400 3400 xxxx xxxx xxxx xxxx

8 bits of each RETLW instructions are zeros, they can have any value.

B) Set the serialization options as following:

S/N size: 4 Bytes

Address: 40H

Start value: 1234ABCDH

Step: 1

S/N mode: BIN

Style: HEX

Save to buffer: LS Byte first

Check the option "Split serial number at every N byte(s)" and split value N set to 2.

(It means split of serial number to buffer at every second Byte)

The correct serial number is set tightly before device programming operation starts.

The buffer content of serial number when programming the first device is:

Address	Data
0000040	34CD 34AB 3434 3412 xxxx xxxx xxxx xxxx

That's it.

Example 3:

Following example uses the same serialization options as Example number 2, instead the serial number split is set to 3 and 4.

When "Split serial number at every 3 byte(s)" is set, the buffer content will look as:

Byte buffer organization:

Address	Data
0000080	CD xx xx AB xx xx 34 xx xx 12 xx xx xx xx xx xx

Word16 buffer organization:

Address	Data
0000040	xxCD ABxx xxxx xx34 12xx xxxx xxxx xxxx

When "Split serial number at every 4 byte(s)" is set, the buffer content will look as:

Byte buffer organization:

Address	Data
0000080	CD xx xx xx AB xx xx xx 34 xx xx xx 12

Word16 buffer organization:

Address Data
0000040 xxCD xxxx xxAB xxxx xx34 xxxx xx12 xxxx

Advice: When you are not sure about effects of serialization options, there is possible to test the real serial number, which will be written to buffer. The test can be made by following steps:

1. select wished serialization options in dialog *Serialization* and confirm these by OK button
2. in dialog *Device operation options* set *Insertion test* and *Device ID check* (if available) to *Disabled*
3. check there is no device inserted to programmer's ZIF socket
4. run *Device Program operation* (for some types of devices it is necessary to select programming options before programming will start)
5. after completing programming operation (mostly with some errors because device is not present) look at the main buffer (*View/Edit buffer*) at address where serial number should be placed

Note: Address for *Serialization* is always assigned to actual device organization and buffer organization that control program is using for current device. If the buffer organization is byte org. (x8), the *Serialization Address* will be byte address. If the buffer organization is wider than byte, e.g. 16 bit words (x16), the *Serialization Address* will be word address.

Device / Device options / Serialization / Classic From file mode

When you use a **Classic From-file mode** the serialization file has serial values directly included. Serialization data are then read directly from serialization file to buffer on address specified in the file. Classic From-file mode is indicated in main window and info window of Pg4uw control program on panel "Serialization" as "**From-file**" serialization.

There are two user options:

Start label

Start label defines the start label in input file. The reading of serial values from file starts from defined start label.

File name

File name option specifies the file name from which serial addresses and values will be read. The input file for *Classis From file* serialization must have correct format.

File format

Classic From-file serialization input file has text format. The file includes addresses and arrays of bytes defining buffer addresses and data to write to buffer. Input file has text type format, which structure is:

```
[label1] addr byte0 byte1 .. byten
...
[labeln]  addr byte0 byte1 .. bytem , addr byte0 byte1 ... bytek
```

; Comment

meaning is:

basic part



Basic part defines buffer address and array of bytes to write to buffer. Basic part must be always defined after label in line.

optional part

Optional part defines the second array of bytes and buffer address to write to buffer. One optional part can be defined after basic part of data.

label1, labeln - labels

Labels are identifiers for each line of input file. They are used for addressing each line of file. The labels should be unique. Addressing lines of file means, the required start label entered by user defines line in input file from which serial values reading starts.

addr -

Addr defines buffer address to write data following the address.

byte0..byten, byte0..bytem, byte0..bytek -

Bytes arrays `byte0..byten`, `byte0..bytem` and `byte0..bytek` are defining data, which are assigned to write to buffer. Maximum count of bytes in one data field following the address is 64 bytes. Data bytes are written to buffer from address `addr` to `addr+n`.

The process of writing particular bytes to buffer is:

```
byte0 to addr
byte1 to addr + 1
byte2 to addr + 2
....
byten to addr + n
```

Optional part is delimited from the first data part by character “ , ” (comma) and its structure is the same as in the first data part, i.e. address and following array of data bytes.

Characters with special use:

[] - labels must be defined inside square brackets

‘ ’ – character which delimiters basic part and optional part of data

‘;’ - the semicolon character means the beginning of a comment. All characters from ‘;’ to the end of line are ignored. Comment can be on individual line or in the end of definition line.

Note:

- *Label names can contain all characters except '[' and ']'. The label names are analyzed as non case sensitive, i.e. character 'a' is same as 'A', 'b' is same as 'B' etc..*
- *All address and byte number values in input file are hexadecimal.*
- *Allowed address value size is from 1 to 4 bytes.*
- *Allowed size of data arrays in one line is in range from 1 to 64 bytes. When there are two data arrays in one line, the sum of their size in bytes can be maximally 80 bytes.*
- *Be careful to set correct addresses. Address must be defined inside device start and device end address range. In case of address out of range, warning window appears and serialization is set to disabled (None).*
- *Address for Serialization is always assigned to actual device organization and buffer organization that control program is using for current device. If the buffer organization is byte org. (x8), the Serialization Address will be byte address. If the buffer organization is wider than byte, e.g. 16 bit words (x16), the Serialization Address will be word address.*

Example of typical input file for Classic From file serialization:

```
[nav1] A7890 78 89 56 02 AB CD ; comment1
[nav2] A7890 02 02 04 06 08 0A
[nav3] A7890 08 09 0A 0B A0 C0 ; comment2
[nav4] A7890 68 87 50 02 0B 8D
[nav5] A7890 A8 88 59 02 AB 7D

;next line contains also second definition
[nav6] A7890 18 29 36 42 5B 6D , FFFF6 44 11 22 33 99 88 77 66 55 16

; this is last line - end of file
```

In the example file six serial values with labels „nav1“, „nav2“, ...„nav6“ are defined. Each value is written to buffer on address \$A7890. All values have size 6 bytes. The line with „nav6“ label has also second value definition, which is written to buffer on address \$FFFF6 and has size 10 bytes, i.e. the last byte of this value will be written to address \$FFFFF.

Note: Address for Serialization is always assigned to actual device organization and buffer organization that control program is using for current device. If the buffer organization is byte org. (x8), the Serialization Address will be byte address. If the buffer organization is wider than byte, e.g. 16 bit words (x16), the Serialization Address will be word address.

Device / Device options / Serialization / Playlist From file mode

When you use a **Playlist From-file mode** the serialization file has not serial values directly included. The file contains name list of external files that contain serialization data. Serialization data are then read from these external data files, each file means one serialization step (one device programmed). Playlist From-file mode is indicated in main window and info window of Pg4uw control program on panel "Serialization" as "**From-file-pl**" serialization.

File format

From-file serialization playlist file includes list of filenames which contain serialization data. The file format is similar to classic serialization file format. Following file format differences are for playlist files:

1. the playlist file must have special header at the first no empty line of file. The header is text line in format
FILETYPE=PG4UW SERIALIZATION PLAYLIST FILE
2. each serial data batch is represented by separate line in format
[label x] datafilename

labelx - represents label

Labels are identifiers for each no-empty line of input file. They are used for addressing each line of file. The labels should be unique within the file. Addressing lines of file means, that the required start label entered by user defines line in input file from which serial values reading starts.

datafilename - defines name of data file, which contains serialization data. When serialization requires new serial value, the data file will be loaded by standard Pg4uw "Load file"



procedure to Pg4uw buffer. File format can be binary or Hex file (Intel Hex etc.). The auto-recognition system recognizes proper file format and forces load of file in the right file format. Data filename is relative to parent (playlist) serialization file.

Example of playlist serialization file:

```
;---- following file header is required -----  
FILETYPE=PG4UW SERIALIZATION PLAYLIST FILE  
  
;---- references to serialization data files  
[nav1] file1.dat  
[nav2] file2.dat  
[nav3] file3.dat  
...  
  
[label n] filex.dat  
;----- end of file -----
```

For more detailed and fully functional example of serialization type From-file playlist, look the example files placed in the Pg4uw installation directory in Examples\ subdirectory as following:

<Pg4uw_inst_dir>\Examples\Serialization\fromfile_playlist_example\

The typical path can look like this:

C:\Program Files\Dataman\Programmer\Examples\Serialization\fromfile_playlist_example\

You can test the serialization by following steps:

1. start Pg4uw
2. you need to have our programmer connected and correctly found in Pg4uw
3. select wished device, the best are devices with erasable memory, (not OTP memory)
4. select dialog from menu Device | Device Options | Serialization
5. Set the From-file mode and in the panel From-file mode options select our example serialization file fromfile_playlist.ser
6. click the OK button to accept the new serialization settings
8. run "Program" device operation

You can see at the serialization indicating labels in the main window of Pg4uw and also in info progress window during device programming and repeating of programming.

Additional operation with used files

This group box contains three types of operation. User can select one of the operation to do with used serialization data files in Playlist From-file mode. Following operations are available:

- **option Do nothing**
program does not make any operation with used serialization data files
- **option Move used file to specified directory**
program moves used serialization data files to user specified directory of used serialization files
- **option Delete used file**
program deletes used serialization data files

Directory

This option is available in playlist From-file serialization mode and selected option "Move used file to specified directory". User can specify target directory, into which used serialization data files will be moved.

Following error indicators are used in Playlist From-file serialization:

- s/n error #3 serialization data file does not exist
- s/n error #34 used serialization data file can not be deleted (maybe serialization files are placed on write-protected disk)
- s/n error #35 used serialization data file can not be moved to target directory of used serialization files (maybe serialization files are placed on write-protected disk, or target directory does not exist)

Device / Device options / Serialization / Custom generator mode

Custom generator serialization mode provide maximum flexible serialization mode, because the user have serialization system fully in his hands.

When Custom generator mode of serialization is selected, serial numbers are generated by user made program "on-the-fly" before each device is programmed in Pg4uw or Pg4uwMC. Custom generator mode serialization allows user to generate unique sequence of serial numbers desired. Serial numbers can be incremented as a linear sequence or completely non-linear sequence. The user made serial number generator program details are described later in the following section **Custom generator program**.

Examples:

There are also example .exe and C/C++ source files available. The files are placed in the Pg4uw installation directory in Examples\ subdirectory as following:

<Pg4uw_inst_dir>\Examples\Serialization\customgenerator_example

The typical path can look like this:

C:\Program

Files\Dataman_sw\Programmer\Examples\Serialization\customgenerator_example

There are following options for **Custom generator serialization** in Pg4uw control software: In dialog Serialization select in **Mode** panel option Custom generator mode. The following options will be displayed:

Serialization data file

Item specifies the path and name for the data file that will contain the current serial number. When device is to be programmed, the Pg4uw software calls user made serial number generator that updates the data file. The recommended extension of data file is .dat. Because many of our customers use also BP Microsystems programmers, they ask us for possibility to be used the same serialization software. Therefore the Serialization data file is compatible with .dat files of "Complex serialization" system, available in BP Micro software,

Note: *The data file is completely and periodically overwritten during device programming with serialization. Be sure to enter the correct name of wished .dat file. Example: "c:\serial_files\serial.dat"*

Serialization generator

Item specifies the path and name for the executable file which will generate serialization data file.

First serial number



This option is required to specify the initial serial number that will be passed to custom generator serialization program. The number is entered and displayed in hexadecimal format.

Last serial number

This option specifies the maximum value of serial number allowed. If the value is non-zero, it will be passed to serialization generator program. The generator is responsible for testing the value of last serial number and generate serial .dat file with appropriate error information in the serialization .dat file in case of current serial number greater then last serial number. If the value of Last serial number is zero, the value will not be passed to generator program.

Check box Call generator with -RESULT parameter after device operation completed

This new option has special purpose. If there is requirement to call custom generator with special parameter -RESULT, the check box should be checked. Otherwise it has to be unchecked (the default state is unchecked). If checked, custom generator is called by Pg4uw control program after each device operation is completed, no matter the result of device operation is OK or Error. Parameters for generator are created by Pg4uw serialization engine. Two parameters are used:

`-RESULT[n]=TRUE | FALSE`

where *n* is optional Programmer Site order number, if multiprogramming is used.

TRUE means that device operation was finished OK. FALSE means, that device operation was finished with error.

`-N<serial number>`

specifies current serial number in the same way, as for normal calling of serialization generator.

Custom generator program

Custom generator program or serialization generator is program that will generate the unique sequence of serial numbers and write the serial data to serialization .dat file. This program is made by user. The path and name of the serialization program must be specified in the Serialization options dialog in Custom generator mode options.

The program will be called from Pg4uw every time the new serial data have to be generated. This is usually made before each device programming operation. Pg4uw control program passes command line parameters to serialization program and serialization program generates serialization .dat file which is read by Pg4uw control program. Following command line parameters are used:

`-N<serial number>` Specifies current serial number.

`-E<serial number>` Specifies ending (or last) serial number. The parameter is only passed when value of Last serial number specified in dialog Serialization in Pg4uw software is no zero. The serialization program should return error record T06 in the serialization .dat file, if the current serial number is greater than ending serial number. For details look at section Serialization .dat file format.

Serialization .dat file format

Serialization .dat file generated by serialization generator must meet following text format.

Serialization .dat file consists of records and serial data section.

Record is line which begins with one of Txx prefixes as described below. Value of "xx" represents the record type code. Records are used to inform Pg4uw software about serialization status (current and last serial numbers, serialization data and data format, errors, etc.). Required records are records T01, T02, T03 and T04. Other records are optional.

<i>T01:<serial number></i>	Contains current serial number value passed to generator by command line parameter -N<serial number>.
<i>T02:<serial number></i>	Contains next serial number value, that Pg4uw will use in next serialization cycle. This value is generated by serialization generator and informs Pg4uw, which serial number will follow after current serial number.
<i>T03:<data format code></i>	Specifies the serialization data format. Following formats are supported now: T03:50 or T03:55 ASCII Space data format T03:99 - Intel Hex data format
<i>T04:</i>	- indicates the serialization data will follow from next line to the end of file. Serialization data are stored in one of standard ASCII data file formats, for example Intel Hex, ASCII Space and so on. The format used for data must be specified by record T03.

Example: Typical serialization data file:

```
T01:000005
T02:001006
T03:99
T04:
:0300000000096B89
:03000300000005F5
:02000C005A0197
:01003F004F71
:00000001FF
```

The file consists of following information:

line T01 - current serial number 000005h

line T02 - ending (last) serial number 001006h

line T03 - serialization data format after line T04 is Intel Hex

line T04 - serialization data, which will be loaded to buffer of Pg4uw before programming device, data are represented in Intel Hex format

Optional records are:

<i>T05:<message></i>	Warning or error message. This record causes the serialization is stopped and warning or error message is displayed in Pg4uw software.
<i>T06:</i>	Current serial number greater than limit This record causes the serialization is stopped and warning or error message is displayed in Pg4uw software. The reason of turning serialization off is the current serial number is greater then allowed maximum ending serial number. This record can be used when -E command line parameter is specified, it means no zero Last serial value in dialog Serialization is specified.



T11:<message> Less important warning or message. The serialization will not be interrupted.

Flowchart of device programming with custom-generator serialization

When Custom-generator serialization is used, it means, that before each device programming is started, serialization engine calls serialization generator executable, to generate serial .dat file. Pg4uw serialization engine manages proper command line parameters for calling of serialization generator. The data from .dat file are immediately read to internal programmer buffer and used as data for programming device. Also next serial number information (record T02) is remembered in Pg4uw.

Typical flowchart of device programming is following:

1. Start of programming batch
2. Device insertion test
3. Serialization sequence, consists from four steps:
 - call of serialization generator with proper command line parameters to generate serialization .dat file
 - waiting for serialization .dat file to be available
 - reading of serialization .dat file data to programmer buffer (the data will be used for programming device)
 - delete serialization .dat file after reading of data from it
4. Device programming
5. Device verification
6. Operation result check.

This is fully managed by Pg4uw control program. Serialization generator does not have to do any operation according to operation result. Control program will call serialization generator with required command line parameters.

OK - Pg4uw makes request for next serial number. Next serial number was read from .dat file in step 3. Call of serialization generator will have next serial number specified in command line.

ERROR - Pg4uw does not make request for new serial number. Recent serial number will be used for next device. Next call of serialization generator will have recent serial number specified in command line.
7. Repeat programming with next device?

Yes go to step 2.
No continue at step 8.
8. End of programming batch

Notes:

In case of error programming result, recent serial number is used, but generator will be called at step 3. anyway, even if the same number is used as for previously programmed device.

If error of serialization .dat file is detected, program Pg4uw reports serialization error and stops continuing of programming batch immediately.

Device / Device options / Statistics

Statistics gives the information about actual count of device operations, which were proceeded on selected type device. If one device is corresponding to one device operation, e.g. programming, the number of device operations will be equal to number of programmed devices.

The next function of statistics is **Count down**. Count down allows checking the number of device operations, and then number of devices, on which device operations have to be done. After each successful device operation the value of count down counter is decremented. Count down has user defined start number of devices to do. When count down value reach zero, it means, specified number of devices is complete and user message about complete count down will be displayed.

Statistics dialog contains following options:

Check boxes **Program**, **Verify**, **Blank**, **Erase** and **Read** define operations, after which statistics values increment.

Any selected and performed device operation will increment the **Total** counter and one of **Success** or **Failure** counters depending on device operation result (success or failure).

A combination of partial operations is counted as one operation only. For example, a Read operation including Verify after Read is one operation. A Program operation including Erase and/or Verify operations is counted as one operation.

Check box **Count down** sets Count down activity (enable or disable). Edit box following the Count down check box defines initial number of count down counter, from which count down starts.

Statistics dialog can be also opened by pressing right mouse button on **Statistics** panel and clicking displayed item **Statistics**.

Actual statistics values are displaying in main window of control program in **Statistics** panel.

Statistics panel contains three statistics values – **Success**, **Failure**, **Total** and two **Count down** information values **Count down** and **Remains**.

Meaning of the values is:

Success	number of operations which where successfully completed
Failure	number of operations which where not successfully completed
Total	number of all operations
Count down	informs about Count down activity (Enabled or Disabled)
Remains	informs about remaining number of device operations to do

Note: *When new device type is selected, all statistics values are set to zero and **Count down** is set to **Disabled**.*

Reset button in **Statistics** panel reset statistics values.

Reload Count down button in **Statistics** panel reloads initial value to **Count down**.

For Pg4uw software, the statistics information is saved to Log window when closing Pg4uw.

For multiprogramming Pg4uwMC software, the statistics information is saved to Job Summary report.

Device / Device options / Associated file

This command is used for setting associated file with current device. This is a file, which can be automatic loaded to buffer after device is selected from default devices select list or by start control program.



You can edit the associated file name in file name box, put a full pathname. The control program checks the present of this file on the disk. Also is possible enabling or disabling automatic load of this file.

You can save both settings i.e. associated file and enabling of automatic load of this file to disk by command **File / Exit and save**.

Device / Device options / Special options

The special terms used here are exactly the terms used by manufacturer of respective chip. Please read the documentation to the chip you want to program for explanation of all used terms.

If the name of this menu item is starting by "View/Edit ...", then the Read device command will read the content of the chip configuration and it can be viewed and edited by this menu command.

Device / Blank check

This command allows to blank check of all devices or its part if possible. The control program reports a result of this action by a write of a warning message to INFO window.

The menu command **Device / Device options / Operation options** allows to set another working area as the standard.

Device / Read

This command allows reading all device or its part into the buffer. The read procedure can also read the content of the chip configuration (if it exists and is readable). The special device configuration areas can be viewed or edited in dialogs available by menu **View / Edit buffer** and menu **Device / Device options / Special options** (Alt+S).

The control program reports a finish of Read action by writing a message to INFO window.

The menu command **Device / Device options / Operation options** allows to set another working area as the standard. Setting an option Verify data after reading in this menu command means a higher reliability for device reading.

Device / Verify

This command compares the programmed data of the all device or its part with data in buffer. The control program reports a result of verify operation to Info window and Log window.

The menu command **Device / Device options / Operation options** allows to set another working area as the standard.

Setting in dialog **General options** (menu **Options / General options**) in tab **Errors** allows to control, how to write the found errors to user specified report file. Also first 45 found errors are written to Log window.

Note:

- *Verify operation compares content of the whole chip with the data in the software, therefore it might happen - in case of incomplete programmed chip - the verification after programming shows none error, but solo verify operation does not pass.*

-
- *Verify operation can report errors also in case of protected devices that have active read protection of data.*

Device / Program

This command allows to programming of the all device or its part by the data of the buffer. The control program reports a result of this action by a write of an error message to INFO window.

The menu command **Device / Device options / Operation options** allows to set another working area as the standard, and set other operation options for programming process control.

Device / Erase

This command allows erasing the whole programmable device. The program reports the end without error or end with the error by writes the warning report on the display.

The Blank check procedure is applied after Chip erase command for such chips, where doesn't exist other way how to check, the chip is really erased.

Device / Test

This command executes a test with device selected from list of supported devices (e.g. static RAM) on programmers, which support this test.

Device / IC test

This command activates a test section for ICs separated by type to any libraries (on distribution CD). First select an appropriate library, wished device and then a mode for test vectors run (LOOP, SINGLE STEP). Control sequence and test results are displayed to LOG WINDOW. In case of need is possible to define the test vectors directly by user. Detailed description syntax and methods of creation testing vectors is described in example_e.lib file, which is in programs installation folder. Note. Because the rising/falling edges of programmers are tuned for programming of chips, it may happen the test of some chips fails, although the chips aren't defective (counters for example).

Device / JAM/VME/...Player

Jam STAPL was created by Altera® engineers and is supported by a consortium of programmable logic device (PLD) manufacturers, programming equipment makers, and test equipment manufacturers.

The Jam™ Standard Test and Programming Language (STAPL), JEDEC standard JESD-71, is a standard file format for ISP (In-System Programming) purposes. Jam STAPL is a freely licensable open standard. It supports programming or configuration of programmable devices and testing of electronic systems, using the IEEE 1149.1 Joint Test Action Group (JTAG) interface. Device can be programmed or verified, but Jam STAPL does not generally allow other functions such as reading a device.

The Jam STAPL programming solution consists of two components: Jam Composer and Jam Player.



The Jam Composer is a program, generally written by a programmable logic vendor, that generates a Jam file (.jam) containing the user data and programming algorithm required to program a design into a device.

The Jam Player is a program that reads the Jam file and applies vectors for programming and testing of devices in a JTAG chain.

The devices can be programmed in ZIF socket of the programmer or in target system through ISP connector. It is indicated by [PLCC44](Jam) or (ISP-Jam) suffix after name of selected device in control program. Multiple devices are possible to program and test via JTAG chain: JTAG chain (ISP-Jam)

More information on the website: <http://www.altera.com>

See please application notes:

"AN 425: Using the Jam Player to Program Altera Devices",

"AN 100: In-System Programmability Guidelines",

"AN 122: Using Jam STAPL for ISP & ICR via an Embedded Processor"

and related application notes for details.

Software tools:

Altera: MAX+plus II, Quartus II, SVF2Jam utility (converts a serial vector file to a Jam file), LAT2Jam utility (converts an ispLSI3256A JEDEC file to a Jam file);

Xilinx: Xilinx ISE Webpack or Foundation software (generates STAPL file or SVF file for use by utility SVF2Jam);

JAM player dialog

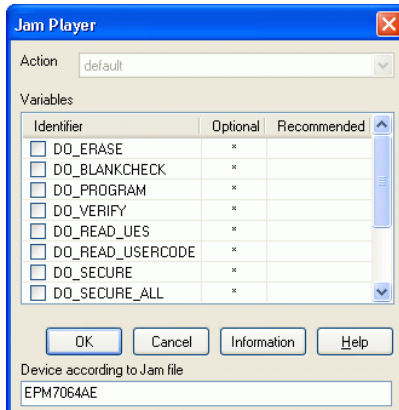

Jam Player version 1 (see Action and Variables controls)

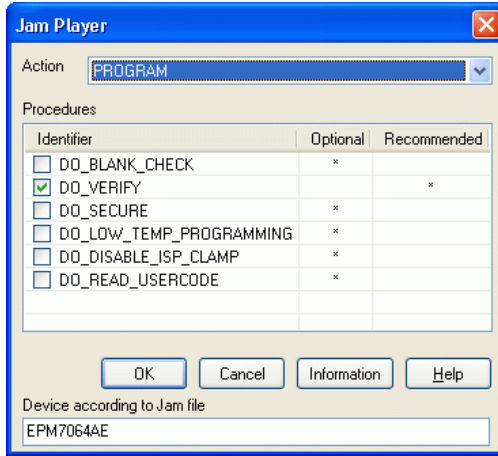

Jam Player version 2 (see Action and Procedures controls)

Action

Select desired action for executing.

Jam file of version 2 consists of actions. Action consists of calling of procedures which are executed.

Jam file of version 1 does not know statements 'action' and 'procedure', therefore choice Action is not accessible. Program flow starts to run instructions according to boolean variables with prefix DO_something. If you need some new boolean variables with prefix DO_something then contact us.

Procedures

Program flow executes statements from each procedure. Procedures may be optional and recommended. Recommended procedures are marked implicitly. You can enable or disable procedures according to your needs. Jam Player executes only marked procedures. Other procedures are ignored. Number of procedures is different, it depends on Jam file.

Variables

Jam file of version 1 does not know statements 'action' and 'procedure'. Program flow starts to run instructions according to boolean variables with prefix DO_something. Jam Player executes all marked DO_something cases in algorithm. Number of variables (procedures) is constant, it does not depend on Jam file. If you need some new boolean variables with prefix DO_something then contact us.

OK

Accept selected action with appropriate procedures which are marked.

Information

Item displays informations about Jam file. You can preview Notes and Source file in dialog.

Device according to Jam file

File is made for a specific device. Device name is found in Jam file in part NOTE identifier DEVICE. Device name must be identical with name of the device selected in dialog Select



device. When devices are different, software will indicate this situation by warning message during start of the Jam Player.

JAM file information dialog

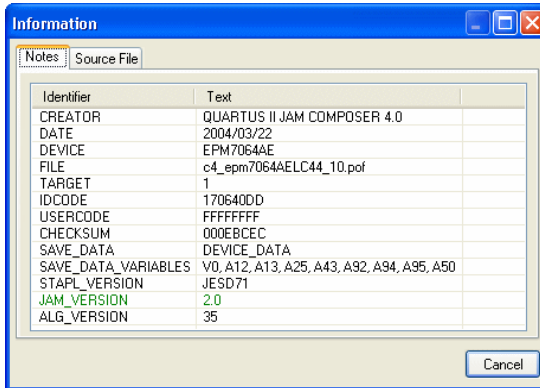

Notes: statements are used to store information about the Jam file. The information stored in NOTE fields may include any type of documentation or attributes related to the particular Jam program.

Source file contains a program in Jam language. Jam program consists of a sequence of statements. Jam statement consists of a label, which is optional, an instruction, and arguments, and terminates with a semicolon (;). Arguments may be literal constants, variables, or expressions resulting in the desired data type (i.e., Boolean or integer). Each statement usually occupies one line of the Jam program, but this is not required. Line breaks are not significant to the Jam language syntax, except for terminating comments. An apostrophe character (') can be used to signify a comment, which is ignored by the interpreter. The language does not specify any limits for line length, statement length, or program size. More information you can find on the website: <http://www.altera.com>

Jam file with extension .jbc is Jam STAPL Byte code format which is not visible.

Converting JED file to Jam STAPL file for XILINX devices:

- install Xilinx Integrated Software Environment (ISE) 6.3i software free download: WebPACK_63_fcfull_i.exe + 6_3_02i_pc.exe (315MB or so)
- run Xilinx ISE 6/Accessories/iMPACT
- in dialog "Operation Mod Selection: What do you want to do first?" choose: "Prepare Configuration Files",
- in dialog "Prepare Configuration Files: I want create a:" choose: "Boundary-Scan File",
- in dialog "Prepare Boundary-Scan File: I want create a:" choose: "STAPL File",
- in dialog "Create a New STAPL File" write name of Jam file with extension .stapl,
- in dialog "Add Device" select JED file with extension .jed,
- in the created jtag chain select device e.g.: XC2C32A (left mouse button) and select sequence operation (e. g.: Erase, Blank, Program, Verify; right mouse button),
- in menu select item "Output/Stapl file/Stop writing to Stapl file"
- run Pg4uw, select device e.g.: Xilinx XC2x32A [QFG32](Jam), load Jam file (Files of type: select STAPL File)

-
- choose “Device operation option Alt+O” press button “Jam configuration”. Warning “Select device from menu “Select Devices” and Jam file is probably different! Continue?” choose Yes. (Xilinx sw. does not include line: NOTE “DEVICE” “XC2x32A”; in Jam file). In dialog “Jam player” select action and procedures, finish dialogs, press button “Play Jam” from toolbar and read Log window

The ispVM Virtual Machine

The ispVM Virtual Machine is a Virtual Machine that has been optimized specifically for programming devices which are compatible with the IEEE 1149.1 Standard for Boundary Scan Test. The ispVM EMBEDDED tool combines the power of Lattice’s ispVM Virtual Machine™ with the industry-standard Serial Vector Format (SVF) language for Boundary Scan programming and test.

The ispVM System software generates VME files supporting both ispJTAG and non-Lattice JTAG files which are compliant to the IEEE 1149.1 standard and support SVF or IEEE 1532 formats. The VME file is a hex coded file that takes the chain information from the ispVM System window. The devices can be programmed in ZIF socket of the programmer or in target system through ISP connector. It is indicated by [PLCC44](VME) or (ISP-VME) suffix after name of selected device in control program. Multiple devices are possible to program and test via JTAG chain: JTAG chain (ISP-VME).

More information on the website:

<http://www.latticesemi.com>

Software tools:

Lattice: ispLEVER, ispVM System ISP Programming Software, PAC-Designer Software, svf2vme utility (converts a serial vector file to a VME file)

Device / Device info

The command provides additional information about the current device - size of device, organization, programming algorithm and a list of programmers (including auxiliary modules) that supported this device. You can find here package information, part number description and full information for ISP implementation. For example: description of ISP connector pins for currently selected chip, recommended target design around in-circuit programmed chip.

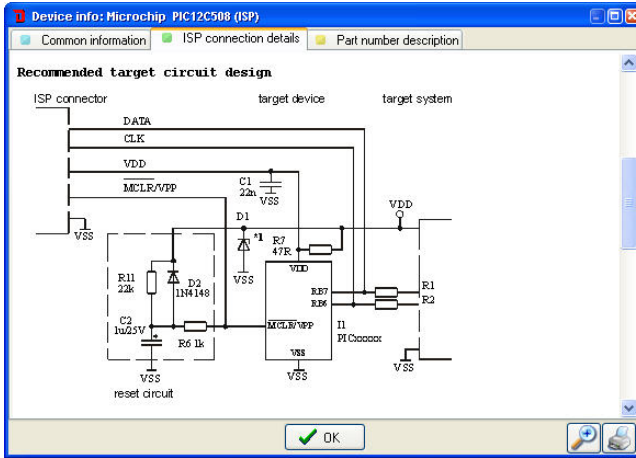

The reserved key <Ctrl+F1> will bring out this menu from any menu and any time immediately.

Programmer

Menu Programmer includes commands used for work with programmers.

Programmer / Find programmer

This item selects a new type of programmer and communication parameters. This command contains following items:

Programmer - sets a new type of programmer for find. If a **Search all** is selected, the control program finds all supported programmers.

Establish communication - allows **manual** or **automatic** establishing communication for a new programmer.

Speed - sets speed, if a manual establishing communication is selected, which PC sends data into the programmer. Speed is expressed as a percent from a maximal speed.

The communication speed modification is important for PCs with "slow" LPT ports, which haven't sufficient driving power for a PC<->programmer cable (laptop, notebook, ...). Use this command, if you have any communication problems with connected programmer on the LPT port of your PC (e.g. control program reports a programmer absence, the communication with the programmer is unreliable, etc.).

If automatic establishing communication is selected, then control program sets a maximal communication speed.

Port - selects a LPT port, which will be scanned for a requested programmer. If All port is selected, the control program scans all LPT ports, which are available on standard addresses.

Address for special port - sets address of LPT port, if a Special port is selected.

Pressing key **<Enter>** or button **OK** initiates scanning for programmer by set parameters. There is same activity as at start the control program. The command clears a list of default devices without the current device, if the new selected programmer supports this one.

This setting is saved to disk by command **Options / Save options**.

Programmer / Refind programmer

This menu command is used to rebind (reestablish communication with) currently selected programmer.

To select other type of programmer, programmer communication parameters and to establish communication with newly selected programmer use menu **Programmer / Find programmer**.

Programmer / Handler

In dialog **Handler** a Handler type and Handler communication parameters can be set. Handler is an external device for special control of device operations in control program. When **None** Handler is selected, this means default state of control program, i.e. device operations are controlled directly by user otherwise control program is in special mode, when device operations are controlled automatically with co-operation with Handler.

Dialog **Handler** contains following items:

Selected Handler select wished Handler type.
Search at port select a COM port, which will be scanned for a requested Handler.

Pressing key **<Enter>** or button **OK** initiates scanning for Handler by set parameters. If selected Handler type is **None**, no Handler scanning will be processed. Current Handler settings are saved to configuration file by command **Options / Save options** or when control program is closed.

Handler is not available for sale.

Programmer / Module options

This option is used for multiple socket programmers for defining MASTER socket and activity of each socket. **MASTER socket** group box allows user to set socket which is preferentially used for device reading operation. **Enable/Disable socket** checkbox array allows user to set enabling and disabling of each socket individually. Disabled sockets are ignored for any device operation.

Programmer / Automatic YES!

This command is used for setting **Automatic YES!** mode. In this mode you just take off the programmed device, then put new device into ZIF socket and a last operation will be repeated automatically. Program automatically detects an insertion of a new device and runs last executed operation without pressing any key or button. An insertion of device into ZIF is displayed on the screen. Repeated operation executing will be cancelled by pressing key **<ESC>** during waiting for insert/remove a device to/from ZIF.



After an operation with a device is executed, one of the OK or ERROR (status) LEDs on the programmer will light in dependence on the result of an operation and the BUSY LED will be blinking.

If the program detects removal of a device, then status LED will be switched off, but the BUSY LED will still be blinking to indicate readiness of the program to repeat last operation with new device.

After the program indicates one or more pins of (new) device in the ZIF socket of the programmer, the BUSY LED will go to light continually. From this the program will wait a requested time for insert the rest pins of new device. If a requested time (Device insertion complete time) overflows and a device is not correctly inserted, the program will light the ERROR LED to indicate this state. After new device was inserted correctly, the program will switch off all status LEDs, except BUSY, and will start an operation with new device.

This mode may be enabled or disabled by item **Automatic YES!** mode. If a new programmer is selected **Options / Find programmer**, this mode will be disabled.

The **Response time** is interval between insertion of the chip into the ZIF socket and the start of selected device operation. If longer positioning of the chip in the ZIF socket is necessary select **elongated** response time.

Programming adapter used shows name of adapter used with currently selected device.

Pins of programmer's ZIF excluded from sensing contains list of pins that will be ignored from testing by Automatic YES!. The reason to ignore the pins is mostly - capacitors connected to these pins.

Button **Setting Automatic YES! parameters** will run wizard that can detect permanently connected pins (pins with capacitors) and set these pins to list of pins excluded from sensing. After selecting of device, list of excluded pins contains default excluded pins for selected device adapter. If other bypass capacitors to universal programmer and/or device adapter are added by customer, there is necessary to run **Automatic YES! parameters wizard** to override default parameters and detect other pins with capacitors.

In **Device removal hold off time** is time period between you removed device from the ZIF socket and the time when software starts to check the socket for new device inserted. This interval is in seconds and must be from 1 to 120 (default value is 2 seconds).

In **Device insertion complete time** is possible to set a time within all pins of the device have to be properly inserted after a first pin(s) detected so that the program will not detect incorrectly inserted device. This interval is in seconds and must be from 1 to 120 (default value is 5 seconds).

The **Suspend on error** defines if the Automatic YES! function will be temporary disabled on error to see result of operation or will go on without suspension.

The options are set to defaults after new device is selected by **Device / Select device**

This setting is saved to disk by command **Options / Save options**.

Note: When using device socket adapters with some passive or active parts, for example capacitors for bypassing supply voltage, the Automatic YES! function may need to set these pins to Pins with capacitors list. This is necessary to make Automatic YES! function working properly. Otherwise Automatic YES! function will "think" the pins are still connected and it will not allow user to insert new device and start new programming.

Programmer / Selftest

Command executes a selftest of current programmer without diagnostic POD. We strongly recommend execute also **Programmer / Selftest plus** of programmer, because Selftest procedure without diagnostic POD is not able to check whole programmer and to discover (if exist) some special errors.

Programmer / Selftest plus

Command executes a selftest plus of current programmer using diagnostic POD, which is included in standard delivery of programmer.

Recommendations how often run Selftest plus you can find at Maintenance section.

Programmer / Self test ISP connector

Command executes a selftest of ISP connector of current programmer using diagnostic POD for ISP connectors.

Diagnostic POD for ISP connectors is necessary to use for testing 6 and 10-pin ISP connectors of programmers. **Diagnostic POD for ISP connectors** is available as optional accessories for programmers with 10-pin ISP connector (DATAMAN-48PRO, DATAMAN-40PRO, DATAMAN-PIKPRO and DATAMAN-T51PRO). The order number: 70 0208

Schematic of Diagnostic POD for ISP connector (if you are in hurry):

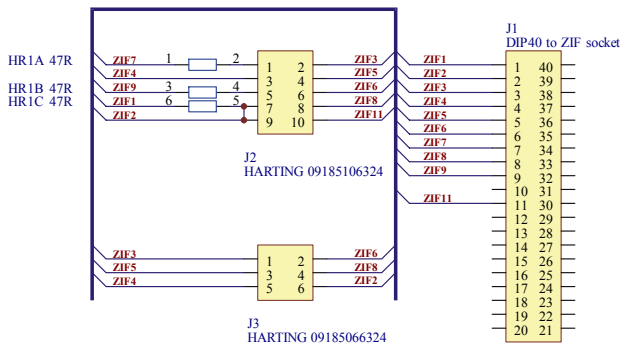



Sequence for testing 10 pins ISP connector:

1. Insert Diagnostic POD for ISP connectors into ZIF socket of the programmer. Diagnostic POD for ISP connectors must be inserted as 40 pins device.
2. Interconnect 10 pins connector of Diagnostic POD for ISP connectors with an ISP connector of the programmer with an ISP cable, included in delivery programmer package. Be sure that pins are interconnected properly (i.e. 1-1, 2-2, ..., 10-10).
3. Run selftest of ISP connector in Pg4uw (Programmer / Selftest ISP connector...).

Diagnostic POD for ISP connectors #2 is used for testing 20 pins ISP connector of programmers. **Diagnostic POD for ISP connector #2** is available as standard accessory for DATAMAN-448PRO2, DATAMAN-448PRO+, DATAMAN-48PRO2 and DATAMAN-48PRO+. The order number: 70-0680.

Schematics of Diagnostic POD for ISP connectors #2 (if you are in hurry):

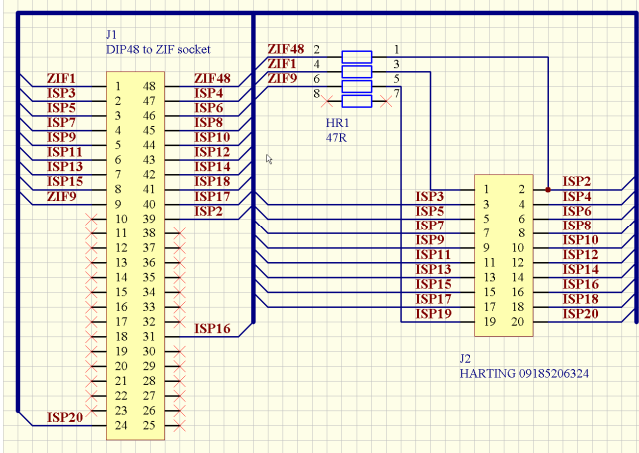

Sequence for testing 20 pins ISP connector:

1. Insert Diagnostic POD for ISP connectors #2 into ZIF socket of the programmer. Diagnostic POD for ISP connectors #2 must be inserted as 48 pins device.
2. Interconnect 20 pins connector of Diagnostic POD for ISP connectors #2 with an ISP connector of the programmer with an ISP cable, included in delivery programmer package. Be sure that pins are interconnected properly (i.e. 1-1, 2-2, ..., 20-20).
3. Run selftest of ISP connector in PG4UW (Programmer / Selftest ISP connector...).

We recommend run this test every 6 months.

Options

The Options menu contains commands that let you view and change various default settings.

Options / General options

General options dialog allows user to control and set variety of Pg4uw program options. The options can be saved to Pg4uw configuration file when closing Pg4uw application, or anytime by command Options / Save options.

File options

File options page allows you to set options for erase buffer before loading, auto-reload of current file and recognition method of file formats for loaded files.

Erase buffer before loading option sets **erasing** buffer (with desired value) automatically before loading of data file.

In group **When current file is modified by another process** you can set mode of reloading of actually loaded (current) file. There are three choices:

- Prompt before reloading file
- Reload automatically
- Ignore change scanning of current file

There are three situations when file modification is tested:

- switching to the control program from another application
- selecting the device operation Verify or Program
- when repeat of last device operation is selected in dialog "Repeat?"

Load file format allows setting mode of file format recognition for loading files. When automatic file format is selected, program analyses format of loading file and test file for each of supported formats that are available in program. If file format matches one of supported formats, the file is read to buffer in detected format.

Manual file format allows user to select explicitly wished file format from list of supported file formats. File may be loaded no completely or incorrectly, if file format does not match to user selected format.

Check box **Show "Load recent project" dialog on program start** sets the dialog to appear on application Pg4uw start. Dialog **Load recent project** contains list of recent projects (project history). User can quickly select and load any of the projects from list, or close the dialog without loading of project file.

File extensions

File extensions page allows you to set file masks.

File format masks is used for setting file-name masks to use as a filter for file listing in **File / Save** and **File / Load** file window for all file formats. Mask must contain one of wildcards (*, ?) at least and must be applied correctly by syntax.

Note: *More masks can be specified for each file format. Semicolon is used as delimiter for extensions.*

Example: *Motorola: *.MOT;*.S19
Defines two file masks *.MOT and *.S19 - for Motorola file format.*

Project file default extension is used for setting project files-extension used as default extension in **File / Load** project and **File / Save** project dialogs.



Buffer

This page allows you to select **Erase buffer before selecting of new device** action. This can be useful for some kind of special devices, which require exact type of data at certain addresses, and the data are not part of data file loaded to buffer for this device.

Buffer can be erased (filled) with default "blank" value for selected device or with custom-defined value. This can be controlled by selection group box **Erase value** and **Custom erase value** edit field.

Notes: *We do not recommend using this function for large devices (more than 8 MB) because it can consume more time to make buffer erase. The setting is saved to Pg4uw configuration file. It is not saved to project file.*

Language

This page allows you to select another language for user interface such as menu, buttons, dialogs, information and messages. It also allows selecting wished help file in another language. For another language support of user interface the language definition file is required.

Sound

Panel **Sound settings** page allows user to select the sound mode of program. Program generates sounds after some activities, e.g. activities on device (programming, verifying, reading, etc.). Program generates sound also when warning or error message is displayed. User can now select sound from Windows system sound (required installed sound card), PC speaker or none sound.

Panel **Allow sound for following actions** contains following options:

- Check box **Successful operation**
When checked, sound will be generated after device operation successfully completed.
When unchecked, no sound will be generated after successful device operation.
- Check box **In case of error**
When checked, sound will be generated after device operation is finished with error.
When unchecked, no sound will be generated after device operation finished with error.

In the panel **Programmer internal speaker sound settings** is possible to set sound options for some programmers with built-in internal speaker. Sound beeps are then generated from internal programmer speaker after each device operation for indicating device operation result – good or bad result.

Errors

This option allows to set a device verify errors saving to file. When verify errors occur, first 45 differences are written to Log window. If user wants to save the verify errors (data differences) to file, he can set options in section **Save device verify errors to file** to one of two methods: cumulate errors from all verify actions to the same file or save errors to file just from last verify action. Verify errors will be saved to file with name specified by **Error file name** edit box. Following error report file options are available:

- option **No** (default) verify errors saving to file is disabled. Errors are displayed just on screen
- option **New** save verify errors to file just from last verify action. Before first write of new verify action is file deleted and created as new one

- option **Append** verify errors from all verify actions are cumulated into the same file. If file does not exist, the new file will be created

Box **Error report file size limit** contains settings that allow setting max. number of verify errors saved to file. It contains following options:

- Check box **Stop verification after max. number of errors reached**
If checked, verify action will finish after **Max. number of errors** will be written in file. If not checked, all verify errors are saved to the file.
- Edit box **Max. number of errors** specifies number of verify errors, that can be written to error file in one verify operation.

Log file

This options associates with using of **Log window**. All reports for Log window can be written into the Log file too. The Log file name is "Report.rep" as default. The control program creates this file with name and directory specified in **Log file name** edit box.

Following Log file options are available:

- **No** default, content of Log window is not copied to Log file, i.e. all reports will be displayed to Log window only
- **New** deletes old Log file and creates new one during each start of control program
- **Append** adds Log window reports into existing Log file, If file does not exist, the new file will be created

Checkbox **Add date information to Log file name** allows user to set date information into Log file name specified by user in Log file name edit box. When the checkbox is checked, program automatically adds current date string into user specified Log file name by the following rules:

If user specified log file name has format:

<user_log_file_name>.<log_file_extension>

The name with added date will be:

<user_log_file_name><-yyyy-mmm-dd>.<log_file_extension>

The new part representing of date consists of yyyy - year, mmm - month and dd - day.

Example: *User specifies Log file name: c:\logs\myfile.log*

*The final log file name with added date will look like this (have a date November, 7th, 2006):
c:\logs\myfile-2006-nov-07.log*

If do you wish to have log file name without any prefix before date information, you can specify the log file name as:

.<log_file_extension> - dot is the first in file name

Example: *User specifies Log file name: c:\logs\log*

*The final log file name with added date will look like this (have a date November, 7th, 2006):
c:\logs\2006-nov-07.log*

Advanced options about Log file size limit are available too.

- option **Use Log file text truncating when file size limit is reached** - when checked, the Log file size limit is on. It means, that when Log file size reaches specified value, the part



of text included in Log file will be truncated. When the option is unchecked, the size of Log file is unlimited, respectively is limited by free disk space only.

- option **Maximum Log file size** specifies the maximum size of Log file in kBytes.
- option **Amount of truncated text** specifies the percentage of Log file text, which will be truncated after Maximum Log file size is reached. The higher value means more text will be truncated (removed) from Log file.

The Log file settings can be saved to disk by command **Options / Save options**.

Job Report

Job Report represents the summary description of operation recently made on device. Job is associated with project file and it means the operation starting with Load project until loading of new project or closing program Pg4uw.

Job Report contains following information:

- project name
- project date
- Protected mode status
- Pg4uw software version
- programmer type and serial number
- start time of executing the Job (it means time when Load project operation was performed)
- end time of executing the Job (time of creating the Job Report)
- device name
- device type
- checksum
- device operation options
- serialization information
- statistics information

Job Report is generated in following cases:

- user command Load project is selected
- closing or disconnecting programmer sites is selected
- closing the Pg4uw
- device Count down counter reaches 0 (finished status)
- manually by user, when menu "File | Job Report" is used

The Job Report is generated for recently loaded project file, only when statistics value of Total is greater than 0.

It means, at least one device operation (program, verify,...) must be performed.

Following options are available for Job Report:

Checkbox **Enable Job Report function** - when checked, the Job Report function is active (enabled). Otherwise the Job Report function is disabled.

Checkbox **Automatically save Job Report file** - when checked, the Job Report will be saved automatically to directory specified in edit field Job Report directory and with file name created as following:

```
job_report_<ordnum>_<prjname>.jrp
```

where

<ordnum> is decimal order of the file. If there are any report files with the same name, then order for new report file will be incremented about order of existing files.

<prjname> is project file name of recently used project, and without the project file name extension.

Example 1:

Let's use the project file c:\myproject.eprj and directory for Job Report set to d:\job_reports\.
There are no report files present in the Job Report directory.

The final Job Report file name will be:
d:\job_reports\job_report_000_myproject.jrp

Example 2:

Let's use the conditions from Example 1, but assume there is already one report file present.
Name of this file is d:\job_reports\job_report_000_myproject.jrp

The final Job Report file name of new report will be:
d:\job_reports\job_report_001_myproject.jrp

Note, the order inside file name is incremented by 1.

When **Automatically save Job Report file** setting is set, no Job Report dialogs appears when generating Job Report. Newly generated Job Report is saved to file without any dialogs or messages (if no error occurs while saving to file).

If the checkbox **Automatically save Job Report file** is unchecked, the Pg4uw will show Job Report dialog every time needed.

In the Job Report dialog user can select operation to do with Job Report. If user selects no operation (Close button), the Job Report will be written to Pg4uw Log Window only. Example of typical Job Report dialog is shown below:

Remote control

Remote control of Pg4uw control program allows controlling some functions of Pg4uw application by other application. This is very suitable feature for integrating device programmer to mass-production handler system or other useful application.

Remote application that controls Pg4uw acts as Server. Program Pg4uw acts as Client. Communication between Pg4uw and remote control program is made via TCP protocol - this allows the Pg4uw to be installed on one computer and remote control application to be installed on another computer, and these computers will be connected together via network.

Default TCP communication settings for remote control are:

Port: **telnet** Address: **127.0.0.1** or **localhost**

Address setting applies for Pg4uw (Client) only. Port setting applies for Pg4uw (Client) and also for Server application.

Default settings allow using remote control on one computer (address localhost). Pg4uw (Client) and remote control Server have to be installed on the same computer.



Note: If firewall is installed on system, firewall can display warning message when remote control Server or Client is starting. When firewall is showing warning with question asking to allow or deny network access for remote Server or Client, please select 'Allow' option, otherwise remote control will not work. Of course you can specify in firewall options more strict rights to allow remote Server/Client access on specified address and port only.

For more information about remote control of Pg4uw and demonstration remote control applications, please see the application note **remotemanual.pdf** placed in subdirectory \RemoteCtrl which is in the directory, where Pg4uw is installed. Manual for remote control is available also from Windows Start / Programs menu link to Remote manual, created during Pg4uw installation.

Save options

Page allows you to select the program options saving when exiting program. Three options are available here:

- Don't save** don't save options during quitting program and don't ask for saving options
- Auto save** save options during quitting program without asking for saving options
- Prompt for save** program asks user for saving options before quitting program. User can select to save or not to save options

Other

Page **Other** allows user to manage other program settings.

Panel **Application priority** allows user to set the priority of the program. Priority settings can affect performance of programmer (device programming time), especially if there are running more demanding applications in the system. Please note that setting application priority level to Low can significantly slow down the program.

In the panel **Tool buttons**, hint display options on toolbar buttons in main program window can be modified. In the panel **Start-up directory** can be selected mode of selecting directory when program starts. **Default start-up directory** means directory, from which program is called. **Directory in which program was lastly ended** means the last current directory when program was lastly ended. This directory assumes the first directory from directory history list.

Options / View

Use the View menu commands to display or hide different elements of program environment such as toolbars.

Following toolbars are available now:

Options / View / Main toolbar

Choose this command to show or hide the Main toolbar.

Options / View / Additional toolbar

Choose this command to show or hide the Additional toolbar.

Options / View / Device options before device operation

Choose this command to enable/disable display of Device options before device operation is confirmed.

Options / Protected mode

Protected mode is special mode of program. When program is in Protected mode, there are disabled program certain operation and commands that can modify buffer or device settings.

Protected mode is used to prevent operator from modifying buffer or device settings due to insignificance. Protected mode is suitable for the programming of a large amount of the same type of devices.

Protected mode function is available independently in single programming control software Pg4uw and in multiprogramming control software **Pg4uwMC**.

Protected mode in Pg4uw

There are two ways how to switch program to Protected mode:

1. by using menu command **Options / Protected mode**. This command displays password dialog. User has to enter password twice to confirm the password is correct. After password confirmation program switches to Protected mode. The entered password is then used to switch off Protected mode.
2. by reading project, that was previously saved in Protected mode. For details see **File / Save project**.

To switch program from Protected mode to normal mode, use the menu command **Options / Normal mode**. The **"Password required"** dialog appears. User has to enter the same password as the password entered during switch to Protected mode.

Other way to cancel Protected mode of program is closing of program, because program Protected mode is active until program is closed. The next program start will be to Normal (standard) mode (the only exception is case of project loaded by command line parameter name of project and the project was saved in Protected mode).

Protected mode in Pg4uwMC

Program Pg4uwMC has Protected mode very similar to program Pg4uw. The difference is, that Protected mode can be activated by menu command but cannot be activated by Project file. Another difference is, that Protected mode settings of Pg4uwMC are saved to configuration .ini file of Pg4uwMC while program Pg4uwMC is closed. During next start of application Pg4uwMC the recent Protected mode settings obtained from .ini file are used.

There is one menu command - **Options / Protected mode** - that allows using Protected mode in application Pg4uwMC. After selecting the menu Options / Protected mode, password dialog appears. User has to enter password twice to confirm the password is correct. After successful password confirmation program switches to Protected mode.

Protected mode settings are saved to configuration .ini file of Pg4uwMC. During next start of program Pg4uwMC the Protected mode settings from .ini file are used.

There is also available one special option - **Keep "Load project" operation allowed**. The option is set to disable at default - it means the Load project operation button and menu will be disabled when Protected mode is active. If the option is enabled (checked), the Load project operation button and menu will be allowed in Protected mode.

To switch program from Protected mode back to Normal mode, use the menu command **Options / Normal mode**. The **"Password required"** dialog appears. User has to enter the same password as the password entered during switch to Protected mode.

When Protected mode is active, the label "Protected mode" is visible near the top of Log window of Pg4uwMC main window.



Note: Sometimes when Protected mode is switched from active state to inactive state (Normal mode), some commands (for example command "Load project") may remain disabled. This can be resolved by clicking on button **Stop ALL**.

Multi-projects

Multi-project is special feature designed to simplify the programming tasks for **multichip devices**.

Multichip device is device with two or more independent chips (of the same or various types) in single package.

Sub-device - an individual part of multichip device. Sub-device is selectable from Pg4uw device list. Once selected, you can work with respective chip in fully manner. You can define, test and save the project file for the partial chip.

Master device - a multichip device unit, consists of sub-devices. Master-device is selectable from Pg4uw device list, too. Once selected, you can use Multi-project Wizard to build-up the Multi-project file from individual project files and save/load/execute it.

Multi-project file is special file that contains user selected project files. Multi-project file can include one or more projects. Projects included in Multi-project (file) are also called sub-projects.

Project file - a special file that combines buffer data, Device operation options, special options and some level of safety features. It completely defines the way how to treat with the device. Once saved, it can be reloaded anytime and the operation can be repeated exactly.

Multi-project Wizard - an assistant for Multi-project file building. The Wizard allows user to select projects that have to be included in Multi-project and save them to one Multi-project file. Process of saving selected project files to one Multi-project file is called Multi-project file building. The Wizard also allows to start device operation according to projects (sub-devices) included in Multi-project. More information about Multi-project Wizard is described below.

Multi-project Wizard

Multi-project device operation requires Multi-project file, which contains partial sub-projects associated to sub-devices (chips) of Master device. Multi-project file can be created in Multi-project Wizard. The Wizard has following main functions:

- Select of sub-projects and build final Multi-project file
- Load of existing Multi-project file *1
- Start device operation of recent Multi-project

Note *1: Existing Multi-project file can be loaded from main menu of Pg4uw using menu File | Load project or from Multi-project Wizard by Load multi-prj command.

Multi-project Wizard contains following controls:

- Button Load multi-prj
Button is used for load of existing Multi-project file.
- Button Build Multi-project
Button is used for build of new Multi-project file, which uses projects listed in table Sub-projects.

- **Table 1: Sub-projects**
Table contains list of projects that are included in recent Multi-project.
- **Button Add project**
Button is used for adding of new project file(s) to list of project files in Table 1.
- **Button Remove project**
Button is used for removing of selected project file from list of project files in Table 1.
- **Buttons Move up a Move down**
Buttons are used for moving of selected project in Table 1 one position up or down. Projects are processed in specified sequence order, the upper-most (#1) as first.
- **Button Help**
Shows this help.
- **Buttons of device operation Blank, Verify, Program, Erase**
Buttons are used for running of selected device operation on all chips (sub-devices) listed in table Sub-projects. One type of operation can be run at a time.

Following two basic actions have to be performed when using Multi-project:

- Making (building) of Multi-project (or Multi-project file)
- Using of Multi-project for running of device operation

Making (building) of Multi-project (or Multi-project file)

Following steps are recommended when making Multi-project file:

- Create "classic" projects, one project for each sub-device of multichip device.
Projects are created in the same way as projects for generic devices:
 - select sub-device according to required chip of multichip device *1
 - set device parameters, settings, and load required device data to buffer by Load file command in Pg4uw
 - optionally make test of device operation by running the device operation on device
 - if everything is OK, the project file can be created by Save project command
- Select Master multichip device, the Multi-project has to be used for. After selection of multichip device, Multi-project Wizard is automatically opened.
- In Multi-project Wizard add required projects by Add project button. Each project represents one sub-device of multichip device.
- After completing of sub-project selection, use button Build Multi-project to create final Multi-project file. Program will prompt for name of new Multi-project file. Final Multi-project file will contain all sub-projects listed in Table 1: Sub-projects.

Notes:

There is possible to create Multi-project from any classic project files. So association with Master device is not mandatory. It is only on user's consideration how to combine correct sub-devices (sub-projects) into one Multi-project. This feature can be especially useful when using ISP programming of devices in JTAG chain with different projects defined.

Multi-project Wizard can be opened by one of following actions:

- *selecting of Master multichip device from Select Device dialog in Pg4uw*
- *loading of created Multi-project file*
- *opening dialog Multi-project Wizard directly from Pg4uw menu Options | Multi-project Wizard*



**1 Convention for Master-device and Sub-device part names in Pg4uw device list:*

*Master-device: Multichip_original_part_name [package_type]
Sub-devices: Multichip_original_part_name [package_type] (part1)
Multichip_original_part_name [package_type] (part2)
...
Multichip_original_part_name [package_type] (part n)*

Example:

*Master-device: TV0057A002CAGD [FBGA107]
Sub-devices #1 TV0057A002CAGD [FBGA107] (NAND)
#2 TV0057A002CAGD [FBGA107] (NOR)*

Using of Multi-project for running of device operation

Typical usage of existing Multi-project file has following order.

For single programming in Pg4uw:

- Load created Multi-project by **File / Load project** menu command in Pg4uw main window or **Load multi-prj** button in Multi-project Wizard.
After successful loading of Multi-project, Multi-project Wizard is opened automatically.
- In Wizard run wished device operation using one of available device operation buttons (Blank, Verify, Program, Erase), mostly Program device operation is used. Selected device operation is executed as sequence of sub-project loading and consequent sub-device programming for each sub-device defined in Multi-project. And this is main purpose of Multi-project - to automate running sequence of device operations for each chip of multichip device. The side effect of this concept is, that device progress indicators are reset to 0 at beginning of each sub-device operation, so it looks like progress bar is "jumping" to 0 few times while multichip operation is running.
- After programming of all sub-devices is completed (or error occurs), standard "Repeat" dialog is displayed. Programmed device can be removed from programmer socket and new device can be inserted. Pressing Yes button in dialog Repeat or YES! button on programmer *, will start multichip device programming sequence again.
* If Automatic YES! function is turned on, no Repeat dialog is displayed after device operation is completed, but Automatic YES! window will appear. The window shows status of programmer socket and notice about removing of programmed device and inserting of new device to programmer socket. After inserting of new device, multichip device operation sequence will start automatically. For more details about Automatic YES! function, please take a look at **Programmer / Automatic YES!**.

For multiprogramming by Pg4uwMC or standalone programmer:

- Load Multi-project by Load project menu.
- Run wished device operation by one of available device operation buttons (Blank, Verify, Program, Erase), mostly Program device operation is used. Selected device operation is executed as sequence of sub-project loading and consequent sub-device programming for each sub-device defined in Multi-project. The side effect of this concept is, that device progress indicators are reset to 0 at beginning of each sub-device operation, so it looks like progress bar is "jumping" to 0 few times while multichip operation is running.
- After programming of all sub-devices is completed (or error occurs), information with result of device operation is displayed in Pg4uwMC. Programmed device can be removed from programmer socket and new device can be inserted. Pressing operation button for

Since the Help system is continuously updated together with the control program, it may contain information not included in this manual.

the Site or YES! button on programmer Site *, will start multichip device programming sequence again.

* If Automatic YES! function is turned on, sequence of device operation is started again automatically after removing of programmed and inserting of new device to programmer socket. For more details about Automatic YES! function, please take a look at **Programmer / Automatic YES!**.

Notes:

- *serialization is not supported in multiprogramming mode (only single programming supports serialization)*
- *count-down function is not supported now*

Options / Save options

This command saves all settings that are currently supported for saving, even if auto-save is turned off. Following options are saved: options under the Options menu, ten last selected devices, file history, main program window position and size.

Help

Menu **Help** contains commands that let you view supported devices and programmers and information about program version too.

Pressing the <F1> key accesses the Help. When you are selecting menu item and press <F1>, you access context-sensitive help. If Pg4uw is executing an operation with the programmer <F1> generates no response.

The following Help items are highlighted:

- words describing the keys referred to by the current Help
- all other significant words
- current cross-references; click on this cross-reference to obtain further information.

Detailed information on individual menu commands can be found in the integrated on-line Help.

Note: *Information provided in this manual is intended to be accurate at the moment of release, but we continuously improve all our products. Please consult manual on www.dataman.com.*

Help / Supported devices

This command displays list of all devices supported by at least one type of all supported programmers. It is useful especially when user wants to find any device supported by at least one type of programmers.



Prefix "g_" before name of device means the device is supported by multi-socket programmer.

Help / Supported programmers

This command displays information about programmers, where supported this program.

Help / Device list (current programmer)

This command makes a list of all devices supported by current programmer and saves it to **????DEV.txt** text file and **????DEV.htm** HTML file in the directory where control program is run from. Marks **????** are replaced by abbreviated name of current programmer, the device list is generated for.

Help / Device list (all programmers)

This command makes device lists for all programmers and saves them to **????DEV.TXT** text files and **????DEV.HTM** HTML files in the directory where control program is running from. Characters **????** are replaced by abbreviated name of programmers, the device lists are generated for.

Note: *The control program loses all information about current device after this command is executed. Reselect wished device again by any of select methods in menu **DEVICE**.*

Help / Device list (cross reference)

This command makes cross reference list of all devices supported by all programmers available on market and supported by this control program. The resulting list is in HTML format and consists of following files:

- one main HTML file **TOP_DEV.htm** with supported device manufacturers listed
- partial HTML files with list of supported devices for each device manufacturer

Main HTML file is placed to directory where this control program for programmers is located.

Partial HTML files are placed to subdirectory **DEV_HTML** placed to the directory where control program for programmers is located.

Programmer / Create problem report

Command Create problem report is used for writing more particular diagnostic information to **Log window** and consequently copy **Log window** content to clipboard. The Log window content can be placed from clipboard to any text editor. Problem report is useful when error occurs in control program or programmer and kind of the error is, that user can not resolve it oneself and he must contact programmer manufacturer. In this case when customer send message to manufacturer about his problem it is good to send also problem report. Problem report can help manufacturer to localize the reason of error and resolve it sooner.

About

When you choose the Info command from the menu, a window appears, showing copyright and version information.

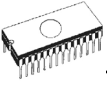

Pg4uwMC

Program **Pg4uwMC** is used for fully parallel concurrent device multiprogramming on more programmers or on one multiprogramming capable programmer connected to USB ports to the same computer.

Pg4uwMC is focused to the easy monitoring of high-volume production operations. Operator-friendly user interface of Pg4uwMC combines many powerful functions with ease of use and provides overview of all important activities and operation results without burden of operator with non-important details.

Pg4uwMC is using a project file to control the multiprogramming system. Project file contains user data, chip programming setup information, chip configuration data, auto programming command sequence, etc. Therefore the operator error is minimized, because the project file is normally created and proofed by engineering and then given to the operator. The optional protected mode can be set for project file to avoid unwanted changes of the project file. Each chip may be programmed with different data such as serial number, configuration and calibration information.

Program Pg4uwMC consists of following main windows:

- main window
- settings dialog window
- "Search for Programmers" dialog window

For more details about multiprogramming and how to use Pg4uwMC, please refer to user's manual for any of our USB interfaced concurrent multiprogramming system (programmer).

The basic description of the main parts of Pg4uwMC

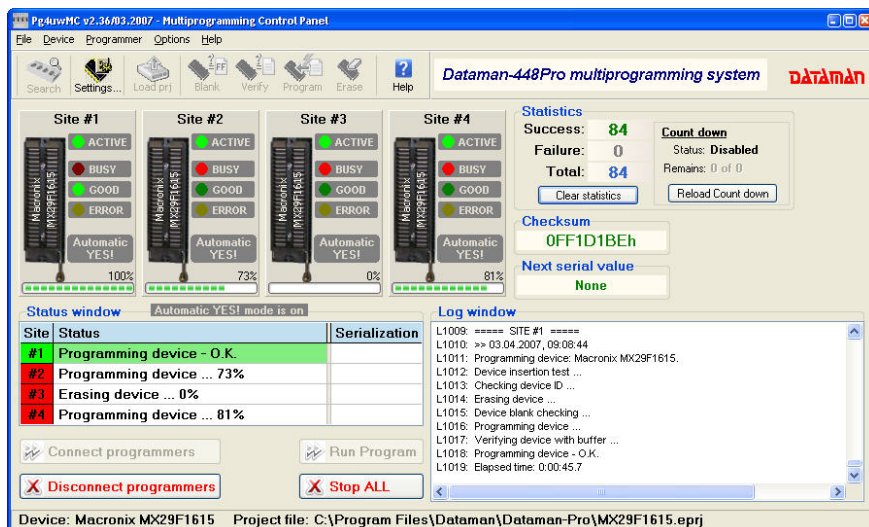

Pg4uwMC main window



Main window of Pg4uwMC consists of following parts:

Menu and tool buttons

Menu and tool buttons allow access to most of Pg4uwMC functions.

Tool button Settings

Button is used to open Pg4uwMC Settings dialog. Settings dialog is described below.

Panels Site #1, Site #2,...

Panels are used to inform about:

- Programmer Site selected
- Programmer Site activity
- current device operation status and/or result

Each panel also contains button **Run** or button **YES!** used to start device operation.

Box Statistics

Box Statistics informs about number of programmed devices and number of good and failed devices.

Checksum

Checksum is showing simple checksum of data loaded from current project file.

Panel Status window

Panel Status window informs about current state of each Site. State can be

Blank Site is no active

Ready Site is active and ready to work. Programmer is connected. No device operation is running.

and other information currently running device operation, result, programmer connection state and so on

Log window on the right side of Status window

Log window contains information about connecting/disconnecting programmers, device operation results and other information.

Button Connect programmers

Button is used to connect all selected Programmer Sites. This button is usually used as the first step after starting Pg4uwMC.

Button Disconnect programmers

Button is used to disconnect all connected Programmer Sites and close Programmer Sites control programs. The button will apply only if no device operation is currently running on any connected programmer.

Button Run <operation>

Button is used to start device operations on all connected programmers at the same time.

The value of <operation> can be one of following types: Program, Verify, Blank check, Erase.

Button Stop ALL

Button is used to stop currently running device operations on all connected Programmer Sites.

Button Help

Button is used to display this help.

Pg4uwMC Settings dialog

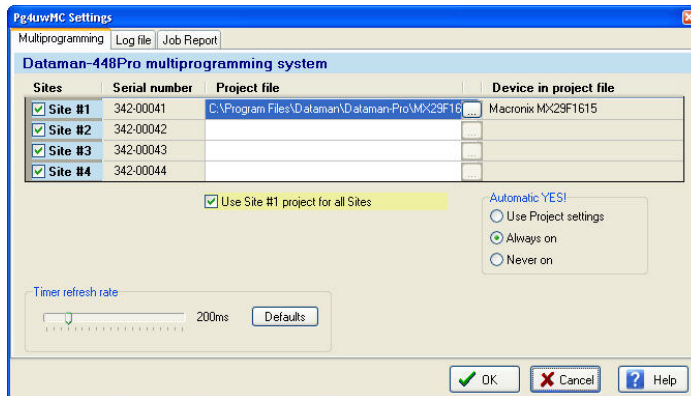

Pg4uwMC Settings dialog is used to set or display following options:

- table containing information / settings for Programmer Sites: Site numbers, Site serial numbers, Site associated Project files
- checkbox Use Site #1 project for all Sites
- checkbox Automatic YES!
- panel Timer refresh rate settings
- panel Log file settings

Table containing information / settings for Programmer Sites

On the top of Pg4uwMC Control panel is table which contains three columns:

- column Sites contains checkboxes with Site numbers #1, #2, #3, #4 used to enable/disable using individual Programmer Site with specified Site number
- column Serial number contains information about serial numbers for Programmer Sites
- column Project file contains edit lines Project: #1, Project: #2, ...Project: #4 for setting individual projects to be loaded after running each Pg4uw. Project file names can be entered manually or by dialog Select project file, which can be opened for each Site by clicking on button "..." placed on the right side of each project edit line. If the project name edit line is blank, the automatic project load will not be performed.

Checkbox Use Site #1 project for all Sites

Checkbox Use Site #1 project for all Sites placed under the Sites numbers and Projects table.

When there is requirement to program the same device types with the same data, the checkbox should be checked.

- If the checkbox is checked, the project file for Site #1 will be used also for all other Programmer Sites. In this mode all Sites are using the same shared buffer of project data and program the same device type.



- If the checkbox is not checked, each Site will use its own project file defined by name in table of Sites in column Project file. In this mode each Site is using its own buffer of project data, which allows to program different data to different types of devices at the same time in each Site.

Checkbox Automatic YES!

Automatic YES! checkbox - when checked, Automatic YES! is set on for all programmers. For more details about Automatic YES! feature see Programmer / Automatic YES. This feature may not be available for some types of programmers.

Panel Timer refresh rate settings

Timer refresh rate defines how often the Pg4uwMC program will request status information from running Programmer Sites. Status information means current device operation type, progress, result and so on. Current status information is displayed in main window of Pg4uwMC. The default timer refresh rate value is 200ms. If you wish faster refresh of status information displayed in Operation panel of Pg4uwMC, select shorter refresh interval. If you notice the system performance slow down, when using faster refresh, select higher refresh value to make refresh less often. On the Pentium 4 computers there is almost no performance penalty depending on timer refresh rate but on slower computers it is sometimes useful to select longer (less often) timer interval.

Panel Log file settings are used to set mode of using Log file report

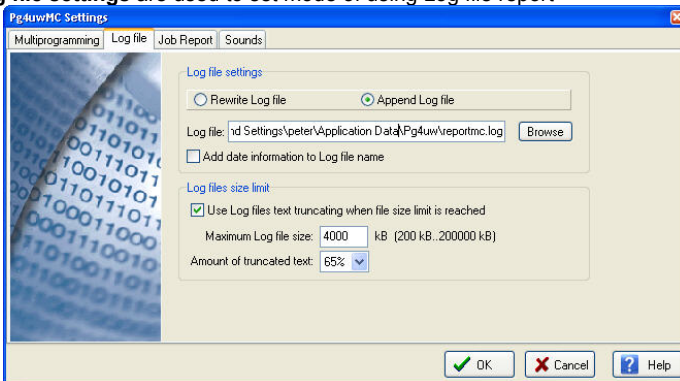

Log file is text file containing information about Pg4uwMC control program operation flow, which means information about loading project files, device operation types and device operation results. Multiprogramming system generates few of Log files. One main Log file of program Pg4uwMC and Log files for each of running Programmer Sites. Each Site has its own one Log file. The name of Site's Log file has the same prefix as the name of Log file specified in edit box Log file. The file name prefix is followed by the number of Site in the form of `_#<Snum>`.

Example:

The Log file name specified by user is: "report.log". Then names of Log files will be:

- Pg4uwMC main Log file name - "report.log"
- Site's #1 Log file name - "report_#1.log"
- Site's #2 Log file name - "report_#2.log"
- Site's #3 Log file name - "report_#3.log"

and so on...

Following options can be set for Log file creation

- option Append Log file sets usage of Log file on. Log file will be created after the first restart of Pg4uwMC. For all other next starts of Pg4uwMC, the existing Log file will be preserved and new data will be appended to the existing Log file.
- option Rewrite Log file sets usage of Log file on. Log file will be created after the first restart of Pg4uwMC. For all other next starts of Pg4uwMC, the existing Log file will be rewritten and new Log file will be created. Data from previous Log file will be deleted.

Checkbox **Add date information to Log file name** allows user to set date information into Log file name specified by user in **Log file name** edit box. When the checkbox is checked, program automatically adds current date string into user specified Log file name by the following rules:

If user specified log file name has format:

<user_log_file_name>.<log_file_extension>

The name with added date will be:

<user_log_file_name><-yyyy-mmm-dd>.<log_file_extension>

The new part representing of date consists of yyyy - year, mmm - month and dd - day.

Example: *User specifies Log file name: c:\Vogs\myfile.log*

*The final log file name with added date will look like this (have a date November, 7th, 2006):
c:\Vogs\myfile-2006-nov-07.log*

If do you wish to have log file name without any prefix before date information, you can specify the log file name as:

.<log_file_extension> - dot is the first in file name

Example: *User specifies Log file name: c:\Vogs\log*

*The final log file name with added date will look like this (have a date November, 7th, 2006):
c:\Vogs\2006-nov-07.log*

Advanced options about Log file size limit are available too:

- option Use Log file text truncating when file size limit is reached - when checked, the Log file size limit is on. It means, that when Log file size reaches specified value, the part of text included in Log file will be truncated. When the option is unchecked, the size of Log file is unlimited, respectively is limited by free disk space only.
- option Maximum Log file size specifies the maximum size of Log file in kBytes.
- option Amount of truncated text specifies the percentage of Log file text, which will be truncated after Maximum Log file size is reached. The higher value means more text will be truncated (removed) from Log file.

Common information:

Index of Programmer Site is integer number from 1 to 8 which defines unambiguously each running Programmer Site.

Serial number of Programmer Site defines unambiguously the programmer or programmer site used. Instance will search all programmers connected on USB Bus until it finds



programmer (site) with desired serial number. Programmers or Programmer Sites with different serial numbers will be ignored. If the Pg4uwMC does not find desired Programmer Site, the Programmer Site will be set to Demo mode with status set to "Not found".

On one computer, 8 Programmer Sites can be run at the same time.

Job Report settings are used to set mode of using Job Report.

Job Report represents the summary description of operation recently made on device. Job is associated with project file and it means the operation starting with Load project until loading of new project or closing program Pg4uwMC.

Job Report contains following information:

- project name
- project date
- Protected mode status
- Pg4uwMC software version
- programmer type and serial number
- start time of executing the Job (it means time when Load project operation was performed)
- end time of executing the Job (time of creating the Job Report)
- device name
- device type
- checksum
- device operation options
- serialization information
- statistics information

Job Report is generated in following cases:

- user command Load project is selected
- closing or disconnecting programmer sites is selected
- closing the Pg4uwMC
- device Count down counter reaches 0 (finished status)
- manually by user, when menu "File | Job Report" is used

The Job Report is generated for recently loaded project file, only when statistics value of Total is greater than 0.

It means, at least one device operation (program, verify,...) must be performed.

Job Report dialog settings are in dialog Pg4uwMC Settings (menu Options | Settings) in tab Job Report.

Following options are available for Job Report:

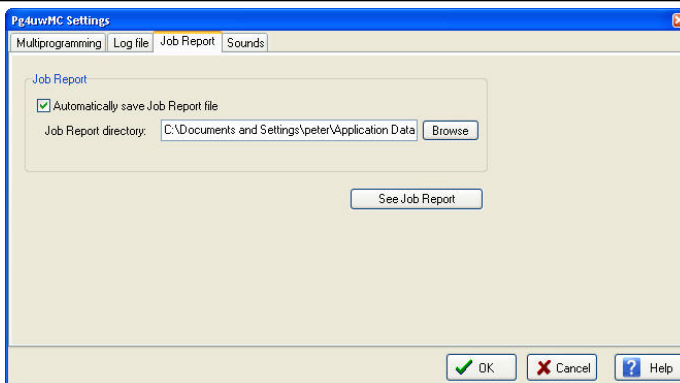

When the checkbox **Automatically save Job Report file** is checked, the Job Report will be saved automatically to directory specified in edit field **Job Report directory** and with file name created as following:

job_report_<ordnum>_<prjname>.jrp

where

<ordnum> is decimal order of the file. If there are any report files with the same name, then order for new report file is incremented about order of existing files.

<prjname> is project file name of recently used project, and without the project file name extension.

Example 1: Let's use the project file *c:\myproject.eprj* and directory for Job Report set to *d:\job_reports*

There are no report files present in the Job Report directory.

The final Job Report file name will be:

d:\job_reports\job_report_000_myproject.jrp

Example 2: Let's use the conditions from Example 1, but assume there is already one report file present.

Name of this file is *d:\job_reports\job_report_000_myproject.jrp*

The final Job Report file name of new report will be:

d:\job_reports\job_report_001_myproject.jrp

Note, the order inside file name is incremented by 1.

When **Automatically save Job Report file** setting is set, no Job Report dialogs appears when generating Job Report. Newly generated Job Report is saved to file without any dialogs or messages (if no error occurs while saving to file).

If the checkbox **Automatically save Job Report file** is unchecked, the Pg4uwMC will show Job Report dialog every time needed.

In the Job Report dialog user can select operation to do with Job Report. If user selects no operation (Close button), the Job Report will be written to Pg4uwMC Log Window only. Example of typical Job Report dialog is shown below:

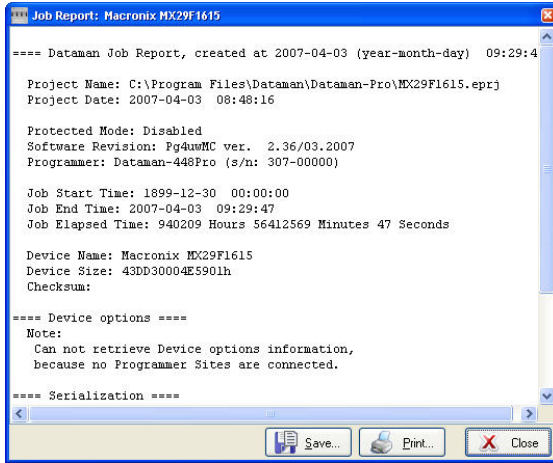

Pg4uwMC "Search for Programmers" dialog

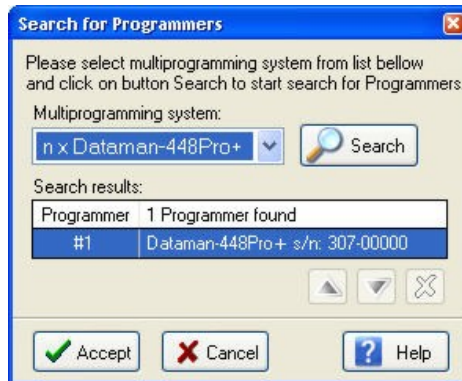

Dialog allows scanning all connected USB devices for programmers matching selected multiprogramming system. After finishing of scanning operation, dialog offers "Search results" list of found programmers. For some multiprogramming systems user can modify the order of Programmer Sites or delete unwanted Programmer Sites. When at least one programmer was found, button "Accept" is enabled and user can click on it to accept new settings.

Command line parameters

Program Pg4uwMC supports following command line parameters:

/prj:<file_name>

Loads project file. Parameter <file_name> means full or relative project file path and name.

There is also available to make Load project operation from command line by entering project file name without prefix /prj:...

Example:

*Pg4uwMC.exe c:\projects\myproject.eprj
Makes load project file "c:\projects\myproject.eprj".*

Programmers supported by Pg4uwMC

The list of currently supported programmers can be displayed in Pg4uwMC by menu Help | Supported programmers. Generally, supported programmers in Pg4uwMC are 48-pin universal programmers with USB interface. Also all of our USB connected multiprogramming systems are supported. Pg4uwMC can handle from 1 to 8 programmer sites. One programmer site means one ZIF socket module.

Troubleshooting

Serial numbers

For successful using of multiply programmers, correct serial numbers must be specified for each used programmer in panel Serial numbers. If there is empty field for serial number, application Pg4uw for the programmer Site won't start.

When Pg4uwMC application is searching for connected programmers in "Search for programmers" dialog, serial numbers of programmers are detected automatically. User does not need (and can not) specify serial numbers by himself.

Communication error(s) while searching for programmers

If some kind of communication error(s) occurs, please close all Pg4uw applications and Pg4uwMC and then start Pg4uwMC and click button "Connect programmers" to start Pg4uw applications for each Site and connect programmers.

All programmers are connected correctly but unstable working

If communication with programmers is lost randomly during device operation (for example device programming), please close other programs, especially programs which consumes large amount of system resources (multimedia, CAD, graphic applications and so on).

***Note:** We also recommend using computer USB ports placed on back side of computer and directly connected to motherboard, because computer USB ports connected to computer motherboard indirectly - via cable, may be unreliable when using high speed USB 2.0 transfer modes. This recommendation is valid not only for programmers, but also for other devices.*

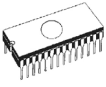

Common notes

Maintenance

We recommend following the instructions and precautions herein to achieve high reliability of the programmer for a long period of time.

The programmer maintenance depends on character and amount of its use. Regardless, the following recommendations are generally accepted:

- Do not use and store the programmer in dusty places.
- Humidity accelerates sedimentation of debris and dust in ZIF socket.
- After end the job cover the ZIF socket of the programmer with enclosed dust cover.
- Do not expose the programmer to direct sunlight or position near a source of heat.

Intensively daily use (programming centre, production)

Daily maintenance

Check the ZIF sockets of the programmer and the socket converters for their condition and wear. Remove debris, dust and grime from the ZIF sockets with clean, dry and compressed air. Clean the ZIF sockets both in closed and opened position.

Weekly maintenance

Perform the "Selftest plus" for every programmer or programming module.

Quarterly maintenance

Gently clean the surface of the programmer with isopropyl alcohol or technical alcohol on a soft cloth. The LCD clean with a soft cloth moistens in water only. Isopropyl alcohol may damage surface of the LCD.

Perform the calibration test if the programmer supports this feature.

Daily use (developing laboratory, office)

Daily maintenance

After end of the job cover the ZIF socket of the programmer with enclosed dust cover. It is also recommended to protect the ZIF sockets of the socket converters from dust and grime.

Weekly maintenance

Check the ZIF sockets of the programmer and the socket converters for their condition and wear. Remove debris, dust and grime from the ZIF sockets with clean, dry and compressed air. Clean the ZIF sockets both in closed and opened position.

Quarterly maintenance

Perform the "Selftest plus" for every programmer or programming module.

Biannual maintenance

Gently clean the surface of the programmer with isopropyl alcohol or technical alcohol on a soft cloth. The LCD clean with a soft cloth moistens in water only. Isopropyl alcohol may damage surface of the LCD.

Perform the calibration test if the programmer supports this feature.

Occasional use

Daily maintenance

After end of the job cover the ZIF socket of the programmer with enclosed dust cover. It is also recommended to protect the ZIF sockets of the socket converters from dust and grime.

Quarterly maintenance

Check the ZIF sockets of the programmer and the socket converters for their condition and wear. Remove debris, dust and grime from the ZIF sockets with clean, dry and compressed air. Clean the ZIF sockets both in closed and opened position.



Biannual maintenance

Perform the “Selftest plus” for every programmer or programming module.

Annual maintenance

Gently clean the surface of the programmer with isopropyl alcohol or technical alcohol on a soft cloth. The LCD clean with a soft cloth moistens in water only. Isopropyl alcohol may damage surface of the LCD.

Perform the calibration test if the programmer supports this feature.

Warning:

The ZIF socket of the programmer and the socket converters are considered as consumables. The life cycle of the ZIF socket of the programmer' is about 25.000 mechanical cycles. The life cycle of ZIF sockets of the socket converters is in generally from 5.000 to 10.000 mechanical cycles, even if the life cycle of some specialized BGA ZIF sockets can be about 500.000 mechanical cycles. Programmed devices, environment and ZIF maintenance have direct influence to actual electrical lifetime of ZIF socket (it means that ZIF socket does not cause programming failures yet). Keep fingers away from contacts of ZIF socket, because contacts of the ZIF socket fouled by smear and grime from fingers may cause the programming failures. Change the ZIF socket or the socket converter if you noticed increased number of programming failures.

The warranty does not apply to the ZIF sockets that are wear or grimy and which cause large amount of failures during working with programmer.

Software

Pg4uw is common control program for some DATAMAN programmers. Thus, during work with him it is possible to find some items, those refer not to current selected programmer.

Command line parameters

We recommend using special utility **Pg4uwcmd.exe** to make command line parameter control of Pg4uw. For backward compatibility there is possible to use some command line parameters also directly with **Pg4uw.exe**, but better way is to use **Pg4uwcmd.exe**, which has support of more command line commands and also it has capability to return ExitCode (or ErrorLevel) value indicating success or error result of executing command line parameters. For more information about using **Pg4uwcmd.exe** command line controller for **Pg4uw**, please take a look at **Remote command line control of Pg4uw**.

Command line parameters which can be used directly with Pg4uw.exe

/Prj:<file_name> forces project load when program is starting or even if program is already running, <file_name> means full or relative project file path and name

/Loadfile:<file_name> forces file load when program is starting or even if program is already running, <file_name> means full or relative path to file that has to be loaded, file format is detected automatically

Please note, the file name Windows conventions must be fulfilled. It means also, that when file name contains spaces, the command line parameter must have the file name bounded inside quotation marks.

Examples:

```
/prj:c:\myfile.eprj
Load project file with name c:\myfile.eprj.
```

```
/loadfile:"c:\filename with spaces.bin"
Load file "c:\filename with spaces.bin" to buffer.
```

```
/Program[:switch] forces start of "Program device" operation automatically when
program is starting, or even if program is already running, also one of
following optional switches can be used:
switch 'noquest' forces start of device programming without question
switch 'noanyquest' forces start of device programming without question and after
operation on device is completed, program doesn't show "Repeat"
operation dialog and goes directly into main program window
```

Examples:

1. /Program
2. /Program:noquest
3. /Program:noanyquest

```
/Close this parameter has sense together with /Program parameter only, and
makes program to close automatically after device programming is
finished successfully
```

```
/Close: always this parameter has sense together with /Program parameter only,
and makes program to close automatically after device programming
is finished, no matter if device operation was successful or not.
```

```
/Eprom_Flash_Autoselect[:xx] forces automatic select EPROM or FLASH by ID when program is
starting or even if program is already running. xx means pins number
of device in ZIF (this time are valid 28 or 32 pins only) and it is
required just for older programmers without insertion test capability.
For others programmers is the value ignored.
```

Basic rules for using of executive command line parameters:

1. command line parameters are not case sensitive
2. command line parameters can be used when first starting of program or when program is already running
3. if program is already running, then any of command line operation is processed only when program was not busy (no operation was currently executing in program). Program must be in basic state, i.e. main program window focused, no modal dialogs displayed, no menu commands opened or executed.
4. order of processing command line parameters when using more parameters together is defined firmly as following:

1. Load project (/Prj:...)
2. Load file (/Load file:...)
3. EPROM/Flash select by ID
4. Program device (/Program[:switch])
5. Close of control program (/Close only together with parameter /Program)

Available command line parameters:

```
/Axxx check programmer present on LPT port with address xxx only
example: /A3bc
/SPP force PC <-> programmer communication in unidirectional mode
```



Available command line parameters for starting program Pg4uw in demo mode

Demo mode is useful in situations, when no programmer device is available. Demo mode can be used by clicking button Demo in dialog Find programmer or by command line parameter /demo. Recommended usage of the parameter is:

```
Pg4uw.exe /demo /<programmer name>
```

where <programmer name> has to be replaced by name of wished programmer as it is used in Pg4uw control program.

Remote command line control of Pg4uw

Pg4uw can accept set of commands from the command line (command line parameters). The remote control can be achieved also by these command line parameters, but more efficient way is to use special tool **Pg4uwcmd.exe**, which has many advantages. The main advantage is size of the **Pg4uwcmd**, which result the calling of **Pg4uwcmd** results a much faster response than calling of Pg4uw directly.

Program Pg4uwcmd.exe can be used to:

1. start Pg4uw application with specified command line parameters
2. force command line parameters to Pg4uw that is already running

Very good feature of Pg4uwcmd.exe is its return code according to command line parameters operation result in Pg4uw.

Return values of Pg4uwcmd.exe

If the command line parameters processed in Pg4uw were successful, the ExitCode (or ErrorLevel) of Pg4uwcmd.exe is zero. Otherwise the ExitCode value is number 1 or more. Return value of program Pg4uwcmd.exe can be tested in batch files.

Following executive command line parameters are available to use with Pg4uwcmd.exe

/Prj:<file_name>	Loads project file. Parameter <file_name> means full or relative project file path and name.
/Loadfile:<file_name>	Loads file. Parameter <file_name> means full or relative path to file that has to be loaded. File format is detected automatically
/Program[:switch]	Forces start of "Program device" operation automatically when program is starting, or even if program is already running. Also one of following optional switches can be used:
switch 'noquest'	forces start of device programming without question
switch 'noanyquest'	forces start of device programming without question and after operation on device is completed, program doesn't show "Repeat" operation dialog and goes directly into main program window

Examples:

4. /Program
5. /Program:noquest
6. /Program:noanyquest

/Close This parameter has sense together with /Program parameter only, and makes program Pg4uw to close automatically after device programming is finished (no matter if operation was successful or not).

/Saveproject:<file_name>

The command is used to save currently selected device type, buffer contents and configuration to project file. Command /Saveproject:... is equivalent to user selected command Save project in Pg4uw control program.

/Eprom_Flash_Autoselect[:xx]

Forces automatic select EPROM or FLASH type by reading of electronic ID from the chip, inserted currently in ZIF socket of programmer. Optional parameter xx means pins number of device in ZIF (this time are valid 28 or 32 pins only) and it is required just for older programmers without insertion test capability. For others programmers the xx parameter can be omitted, because is ignored.

Examples:

/Eprom_Flash_Autoselect

/Eprom_Flash_Autoselect:32

/writebuffer:ADDR1:B11,B12,B13,B14,...,B1N[::ADDR2:B21,B22,B23,B24,...,B2M]...

Command /writebuffer is used to write block of Bytes to Pg4uw main buffer at specified address. Write buffer command has one block of data required and other block(s) of data (marked with [...]) optional. Please do not use spaces or tabs in the command.

Buffer address is always defined as Byte address, it means, that for buffer organization x16, the address AAAAx16 in buffer has to be specified in command /writebuffer as 2*AAAA (x8).

Example 1:

/writebuffer:7FF800:12,AB,C5,D4,7E,80

Writes 6 Bytes 12H ABH C5H D4H 7EH 80H to buffer at address 7FF800H.

The addressing looks like following:

the first Byte at the lowest address

Buffer Address	Data
7FF800H	12H
7FF801H	ABH
7FF802H	C5H
7FF803H	D4H
7FF804H	7EH
7FF805H	80H

Example 2:

/writebuffer:7FF800:12,AB,C5,D4,7E,80::FF0000:AB,CD,EF,43,21

Writes two blocks of data to buffer.

The first block of data - 6 Bytes 12H ABH C5H D4H 7EH 80H are written to buffer at address 7FF800H in the same way as in Example 1.

The second block of data - 5 Bytes ABH CDH EFH 43H 21H are written to buffer at address FF0000H.

The addressing looks like following:

the first Byte at the lowest address

Buffer Address	Data
FF0000H	ABH
FF0001H	CDH
FF0002H	EFH
FF0003H	43H

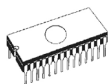

FF0004H 21H

/writebufferex:INDEX:ADDR1:B11,B12,B13,B14,...,B1N[::ADDR2:B21,B22,B23,B24,...,B2M].

Command /writebufferex is used to write block of Bytes to Pg4uw main buffer at specified address. The command is very similar to command /writebuffer, except one more parameter – INDEX.

The INDEX parameter specifies the order of buffer, where data will send. The main buffer has index '1'. The first secondary buffer has index '2', etc. Please note, the secondary buffer(s) is(are) available for some kinds of devices only (e.g. Microchip PIC16F628). The kind of buffer indexed by parameter buffindex depends on order of buffer in application Pg4uw in dialog View/Edit buffer. For example device Microchip PIC16F628 has additional buffer with label "Data EEPROM". This buffer can be accessed for data write(s) by this function when buffindex = 2 is specified.

Example 1:

/writebufferex:1:7FF800:12,AB,C5,D4,7E,80

The command is equivalent to command

/writebuffer:1:7FF800:12,AB,C5,D4,7E,80

described in section about command /writebuffer.

Example 2:

/writebufferex:2:2F:12,AB,C5,D4,7E,80

The command writes 6 Bytes 12H ABH C5H D4H 7EH 80H to secondary buffer with index "2" at address 2FH. The addressing looks like following:

the first Byte at the lowest address

Buffer Address	Data
00002FH	12H
000030H	ABH
000031H	C5H
000032H	D4H
000033H	7EH
000034H	80H

Basic rules for using of executive command line parameters:

1. program Pg4uwcmd.exe must be located in the same directory as program Pg4uw.exe
2. if Pg4uw.exe is not running when Pg4uwcmd.exe is called, it will be automatically started
3. command line parameters are not case sensitive
4. command line parameters can be used when first starting of program or when program is already running
5. if program is already running, then any of command line operation is processed only when program was not busy (no operation was currently executing in program). Program must be in basic state, i.e. main program window focused, no modal dialogs displayed, no menu commands opened or executed
6. order of processing command line parameters when using more parameters together is defined firmly as following:
 - step1 Load file (/Loadfile:...)
 - step2 Load project (/Prj:...)
 - step3 EPROM/FLASH autoselect
 - step4 Program device (/Program[switch])
 - step5 Close of control program (/Close only together with parameter /Program)

Example 1:

```
Pg4uwcmd.exe /program:noanyquest /loadfile:c:\empfile.hex
```

Following operations will perform:

1. start Pg4uw.exe (if not already running)
2. load file c:\empfile.hex
3. start program device operation without questions
4. Pg4uwcmd.exe is still running and periodically checking status of Pg4uw.exe
5. when device programming completes, Pg4uwcmd.exe is closed and is returning ExitCode depending on load file and device programming results in Pg4uw.exe. When all operations were successful, Pg4uwcmd.exe returns 0, otherwise returns value 1 or more.

Example 2:

```
Pg4uwcmd.exe /program:noanyquest /prj:c:\emproject.eprj
```

The operations are the same as in Example 1, just Load file operation is replaced by Load project file c:\emproject.eprj command.

Example 3:

Using Pg4uwcmd.exe in batch file and testing return code of Pg4uwcmd.exe.

```
rem ----- beginning of batch -----
@echo off
rem Call application with wished parameters
Pg4uwcmd.exe /program:noanyquest /prj:c:\emproject.eprj
rem Detect result of command line execution
rem Variable ErrorLevel is tested, value 1 or greater means the error occurred
if ErrorLevel 1 goto FAILURE
echo Command line operation was successful
goto BATCHEND
:FAILURE
echo Command line operation error(s)
:BATCHEND
echo.
echo This is end of batch file (or continue)
pause
rem ----- end of batch -----
```

Example 4:

Let's assume the Pg4uw control program is running, and has user selected device. We need to load required data to Pg4uw device buffer and save the selected device settings and buffer content to project file. Data required for device are stored in file c:\15001-25001\file_10.bin. Project file will be stored at c:\projects\project_10.eprj.

Following command line parameters should be specified to realize wished operation:

```
Pg4uwcmd.exe /loadfile:c:\15001-25001\file_10.bin /saveproject:c:\projects\project_10.eprj
```

When Pg4uw receives the commands, it will do following procedures:

1. loads data file c:\15001-25001\file_10.bin
2. saves the currently selected device settings and buffer data to project file c:\projects\project_10.eprj

If the result of operations performed is OK, Pg4uwcmd application will return ExitCode (or ErrorLevel) value 0.

If there are some errors (can not load file or save to project file), Pg4uwcmd application will return ExitCode value equal or greater than 1.



Note: When using the above commands, user must be sure the Pg4uw is not performing any device operation, for example device programming. If the Pg4uw is busy, it will refuse the commands and returns error status (ExitCode equal or greater than value 1).

Hardware

Due a large variety of parallel port types, a case may occur when the programmer cannot "get concerted" with the PC. This problem may be shown as none communication between the PC and the programmer, or by unreliable communication. If this behavior occurs, try to connect your programmer to some other PCs or other parallel ports near you.

If you find none solution, please document the situation, i.e., provide us an accurate description of your PC configuration, including some other circumstances bearing on the problem in question, and advise the manufacturer of your problem. Don't forget please enter of PC type, manufacturer, speed, operation system, resident programs; your parallel port I/O manufacturer and type. Use please **Device problem report** form for this purpose.

Warning:

Class A ITE notice

Devices described at this manual are class A products. In domestic environment this products may cause radio interference in which case the user may be required to take adequate measures.

Because DATAMAN-448PRO2, DATAMAN-448PRO+, DATAMAN-48PRO2 and DATAMAN-48PRO+ have internal power supply, follow these special precautions:

- *Circuit breakers (overcurrent protection) must be a part of building electrical installation.*
- *Pull out power cord plug from outlet to disconnect programmer from mains. The outlet must be placed near to programmer and must be easy accessible.*

ISP (In-System Programming)

Definition

In-system programming allows programming and reprogramming of device positioned inside the end system. Using a simple interface, the ISP programmer communicates serially with the device, reprogramming nonvolatile memories on the chip. In-system programming eliminates the physical removal of chips from the system. This will save time and money, both during development in the lab, and when updating the software or parameters in the field.

Target device is the device (microcontroller, PLD, etc...), which is to be in-system programmed.

Target system is the physical Printed Circuit Board (PCB), which contains the device to be in-system programmed.

ISP programmer is programmer, which has in-system programming capability (for example DATAMAN-48PRO2, DATAMAN-48PRO+, DATAMAN-40PRO, DATAMAN-T51PRO, DATAMAN-PIKPRO...).

General rules for in-system programming

We recommended respect following rules to avoid damage PC, ISP programmer, and target device or target system:

- Ensure common earth point for target system, ISP programmer and PC.
- For laptop or other PC that is not connected to common earth point: make hard - wired connection from laptop to common earth point (for example use LPT or COM port D – connector).
- Any devices connected to target system must be connected to common earth point too.

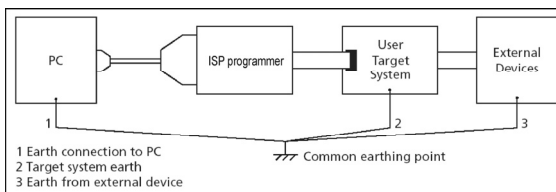

Direction of connect DATAMAN ISP programmer to target system:

During in-system programming you connect two electrical devices – ISP programmer and target system. Unqualified connection can damage these devices.

Note: When you don't keep below directions and you damage programmer during in-system programming, it is damage of programmer by unqualified manipulation and is out of warranty.

1. Turn off both devices – ISP programmer and target device.
2. Assign same GND potential for all devices, e.g. connect GND of all devices by wire.
3. Insert one connector of ISP cable to ISP programmer, turn on programmer and control program.
4. In control program select target device and operation options.
5. Start action on target device (read, program).
6. After direction of control program, connect other ISP cable connector to target system and turn on it.
7. After direction of control program, disconnect other ISP cable connector from target system and turn off it.
8. If you need another action on target device, you continue with step 5.

The recommendation for design of target system with ISP programmed device

The target system must be designed to allow all signals, which are use for In-system programming to be directly connected to ISP programmer via ISP connector. If target system use these signals for other function, is necessary isolated these signals. Target system mustn't affect these signals during In-system programming.

For in-system programmable devices manufacturers publish application notes. Design of DATAMAN programmers together with respect of these application notes allows proper In-system programming. Condition is exactly respecting these application notes.

Please, read some notes for following recommended circuits.

- Purpose of D1 diode is to protect the target circuit against a higher voltage, which is provided by ISP programmer.
- If your target board supply differs from mentioned 5V, choose please the Zener diode (D1) voltage according to this supply voltage.



- We recommend using resistors R1, R2, (R3) to separate the target device from target system. If pins needed for ISP programming are inputs in target system then separation by resistors is sufficient and resistors make a low pass filter too. If pins are outputs, then use of resistors saves a programming time. Of course the isolation resistors R1, R2, (R3) can be replaced by switches or jumpers, if necessary. In that case, during the ISP programming of target device the switches (jumpers) must be open. But the using of switches (jumpers) adds a next manipulation time to programming procedure.

Other

There is needful for regular running of control program for any DATAMAN programmer that printer port, on which is programmer connected, must be reserved for this programmer only. Otherwise, any other program must not simultaneously to use (or any way to modify) this printer port.

Pg4uw SW can handle all modes of LPT port (full IEEE 1284 support), thus you don't need to configure LPT port for connection of DATAMAN programmers.

Please don't move **Info** window during BUSY LED is on - watching circuit can be activate to switch the programmer in safe status as in case communication PC-programmer error.

LPT port driver

For programmers connected through parallel LPT port, control program requires correctly installed LPT port driver. LPT port driver installation and uninstallation is made automatically by installation program. Normally there are no problems with the driver. But sometimes driver can not be initialized correctly. It is especially in the case that no LPT1 port is present in the Windows NT/2000/XP operating systems. When the LPT port driver is not initialized, control program can not detect any LPT ports in the system.

If LPT port on PCMCIA or Express Card is used, the card must be installed in computer before starting of operating system.

LPT driver requires port LPT1 to be present in the operating system. Please check the parallel port LPT1 is present in the system.

The short description, how to see LPT ports present in operating system:

1. click to "Start" menu
2. click with right mouse button to "My computer" item and select menu "Properties"
3. in the "System properties" dialog select "Hardware" page and click to "Device manager" button
4. in the "Device manager" dialog select "Ports (Com & LPT)" (double click), it will show the list of all present LPT and COM ports

There should be displayed at least one present LPT port.

If there are present one or more LPT ports but with numbers other than LPT1, it is necessary to change one of the LPT ports to LPT1 port. Follow the steps bellow (continued from steps 1 - 4.)

5. double click to selected LPT port to show properties of the port
6. in the "LPT port properties" dialog select the page "Port settings"

7. change number of LPT port to LPT1 by "LPT Port Number" setting
 8. click OK button
 9. restart the operating system
- (even if system does not require restart, it is necessary to perform system restart to correctly initialize our LPT port driver)

That's all. Our software should work properly with LPT connected programmer.
When using programmer connected through USB, there is no need of LPT port driver.

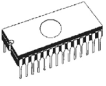

Troubleshooting and warranty

Troubleshooting

We really want you to enjoy our product. Nevertheless, problems can occur. In such cases please follow the instructions below.

- It might be your mistake in properly operating the programmer or its control program Pg4uw.
 - Please read carefully all the enclosed documentation again. Probably you will find the needed answer right away.
 - Try to install programmer and Pg4uw on another computer. If your system works normally on the other computer you might have a problem with the first one PC. Compare differences between both computers.
 - Ask your in-house guru (every office has one!).
 - Ask the person who already installed programmer.
- If the problem persists, please call the local dealer, from whom you purchased the programmer, or call DATAMAN direct. Most problems can be solved by email, fax or phone.
 - **E-mail** – Complete and submit the "**TECHNICAL SUPPORT REQUEST**" available from our website www.dataman.com. Include everything that you consider being relevant about the programmer, software and the target device.
 - **Mail/fax** – Print and complete the "**RETURNS FORM**" available from our website www.dataman.com. Include everything that you consider being relevant about the programmer, software and the target device. Send the completed form by mail or fax to DATAMAN (fax number in the control program, menu **Help / About**) or to your local dealer.
 - **Phone** - Call your local dealer or DATAMAN's customer support center (phone number in the control program, menu **Help / About**).
- If your programmer is diagnosed as defective, consult your local dealer or DATAMAN about the pertinent repair center in your country. Please carefully include the following items in the package:
 - Defective product
 - Completed "**RETURNS FORM**" available from our website www.dataman.com.
 - Photocopy of a dated proof of purchase

Without all these items we cannot admit your programmer to repair.

Note:

You may find the "**DEVICE PROBLEM REPORT**" form:

- at our Internet site (www.dataman.com), section Support / Problem report.

If you have an unsupported target device

If you need to operate on a target device not supported by the control program for programmer, please do not despair and follow the next steps:

- Look in the device list of the latest version of the control program on our Internet site (section Download, file corresponded to your programmer). Your new target device may already be included in this version! If yes, download and install the new version of the control program.



- Contact DATAMAN directly by completing and submitting the "**TECHNICAL SUPPORT REQUEST**" available from our website www.dataman.com. We may need to request data sheets and samples of your target device. Any samples will be returned to you after we include your target device in a new version of Pg4uw.

Warranty terms

The manufacturer, Dataman Programmers Ltd, gives a guarantee on failure-free operating of the programmer and all its parts, materials and workmanship for **three years** (DATAMAN-448PRO2, DATAMAN-448PRO+, DATAMAN-48PRO2, DATAMAN-48PRO+ and DATAMAN-40PRO) and **one year** (DATAMAN-T51PRO, DATAMAN-PIKPRO and DATAMAN-MEMPRO) from the date of purchase. This warranty is limited to 25,000-cycles on DIL ZIF socket or 10,000-cycles on other ZIF sockets). If the product is diagnosed as defective, Dataman Programmers Ltd or the authorized repair center will repair or replace defective parts at no charge. Parts used for replacement and/or whole programmer are warranted only for the remainder of the original warranty period.

For repair within the warranty period, the customer must prove the date of purchase.

This warranty terms are valid for customers, who purchase a programmer directly from Dataman company. The warranty conditions of Dataman sellers may differ depending on the target country law system or Dataman seller's warranty policy.

The warranty does not apply to products that are of wear and tear or mechanically damaged. Equally, the warranty does not apply to products opened and/or repaired and/or altered by personnel not authorized by Dataman, or to products that have been misused, abused, accidentated or that were improperly installed.

For unwarrantable repairs you will be billed according to the costs of replacement materials, service time and freight. Dataman or its distributors will determine whether the defective product should be repaired or replaced and judge whether or not the warranty applies.

Please also see Troubleshooting section.

<p>Manufacturer: ✉: Dataman Programmers Ltd Station Road Maiden Newton Dorset DT2 0AE United Kingdom ☎: + 44 0 1300 320719 www.dataman.com, sales@dataman.com</p>
--

Dataman has used its best efforts to develop hardware and software that is stable and reliable. Dataman does not guarantee that the hardware and software are free of "bugs", errors or defects. Dataman 's liability is always limited to contract's net value paid by a buyer.

Dataman is not liable for:

- Damage caused by inappropriate use or handling of products.

- Damage caused by users or third parties modifying or trying to modify products.
- Any further damage or consequent damage caused by hardware errors or software “bugs”.

For example: *lost profits, lost savings, damages arised from claims of third parties against a client, damage or loss of recorded data or files, renown, loss caused by impossibility to use etc.*