



Contents

Panorama

Metal Casing	2, 3
Plastic Casing	2, 3

Applications - Description - Type - Implementation

Metal Casing IP66 LS32M..., LS33M..., LS35M... and LS72M..., LS73M..., LS75M...	4, 5
Plastic Casing IP65 LS72P..., LS73P..., LS75P...	6, 7

Travel and Operation Diagrams	8
--	---

Technical Data	9 to 11
-----------------------------	---------

Selection Table and Functional Characteristics

Metal Casings: 30 mm width	12 to 23
60 mm width	24 to 35
Plastic Casing: 60 mm width	36 to 47

Accessories	48
--------------------------	----

Standard	49
-----------------------	----

Terminology	50
--------------------------	----

Utilization Precautions	51
--------------------------------------	----

Ordering Details

Metal Casings: 30 mm width	52 to 59
60 mm width	60 to 67
Plastic Casing: 60 mm width	68 to 75
Accessories	76

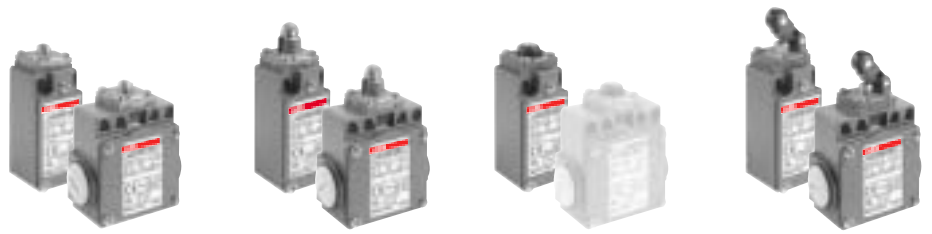

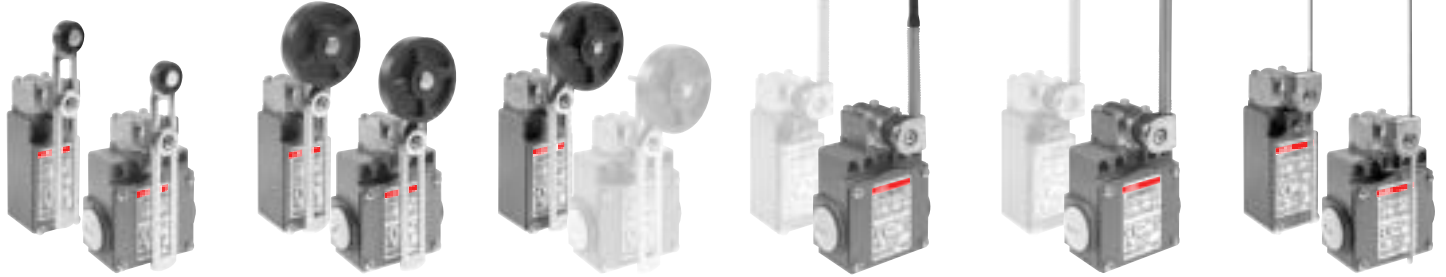

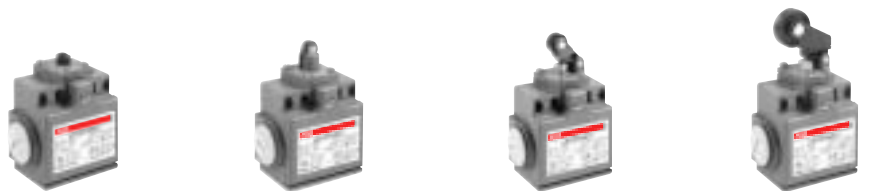
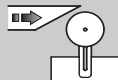
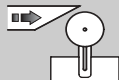







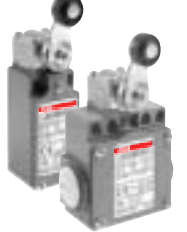
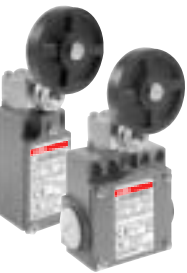
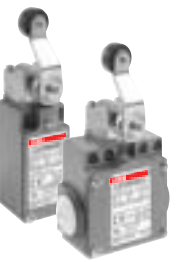







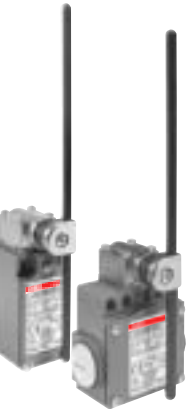

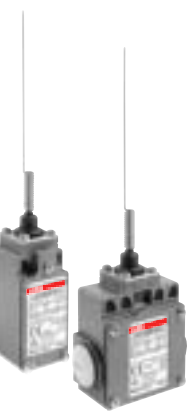
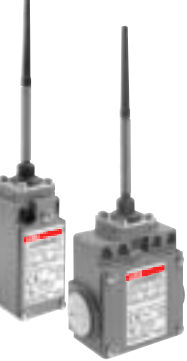







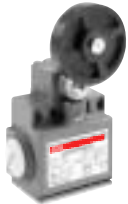







Limit Switches

					
LS...M32	LS...M35	LS...M38	LS...M41, LS...M43	LS...M42	LS...M45, LS...M46
Roller lever	Roller lever	Adjustable roller lever	Roller lever	Roller lever	Roller lever
					
-	-	-	EN 50047	-	-
					
LS...M73	LS...M74	LS...M78	LS...M91	LS...M92	LS...M98B11-A
Adjustable rod lever	Adjustable rod lever	Adjustable rod lever	Flexible rod	Flexible rod	Pull action
					
-	-	-	-	-	-
					
LS...P41, LS...P43	LS...P42	LS...P51, LS...P53	LS...P71, LS...P72	LS...P91	LS...P98
Roller lever	Roller lever	Adjustable roller lever	Adjustable rod lever	Flexible rod	Pull action
					
-	-	-	-	-	-

LS32M..., LS33M..., LS35M... and LS72M..., LS73M..., LS75M... Limit Switches

Metal Casing IP66

Implementation

- Head orientation.

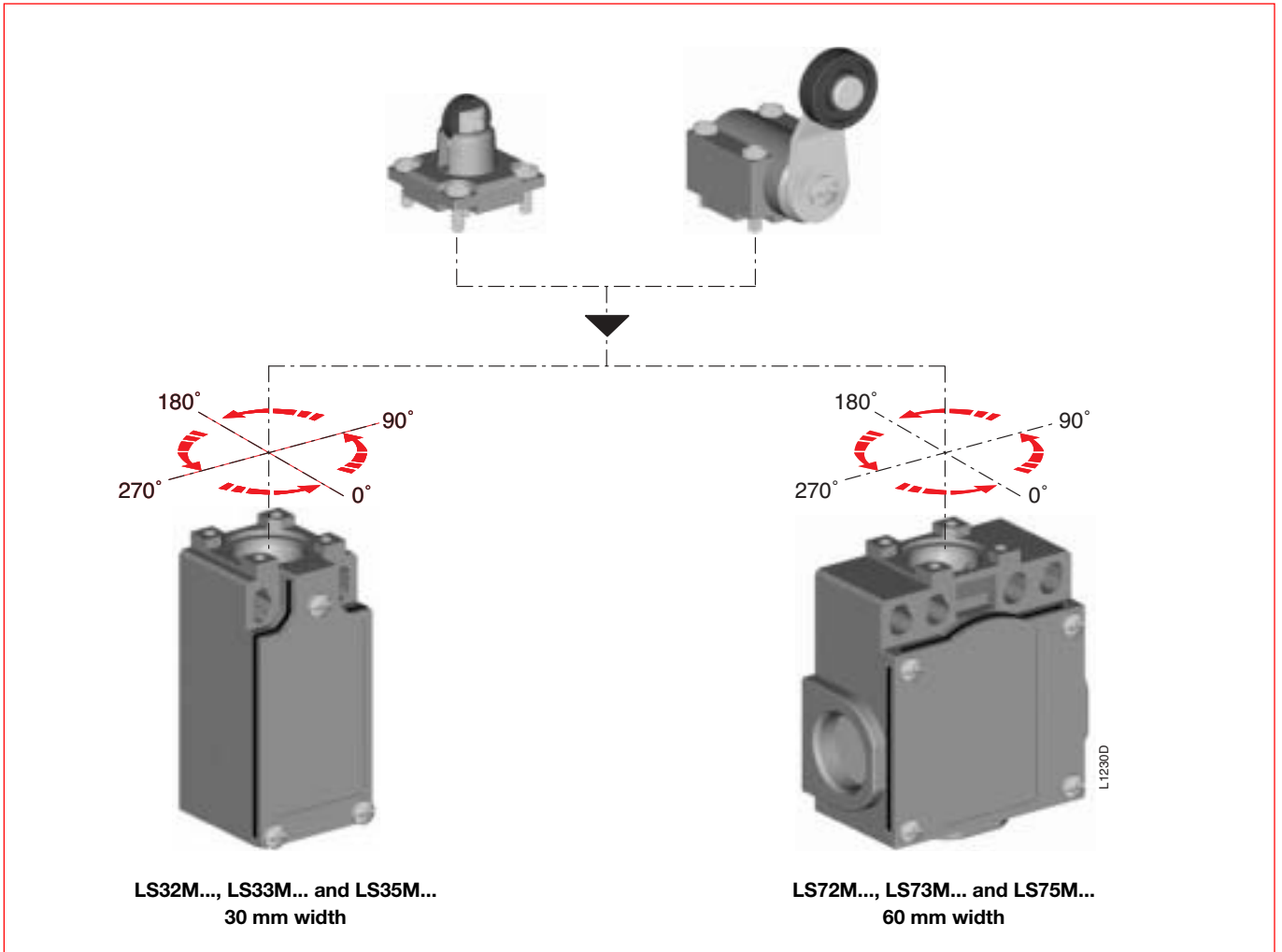

- Free position adjustment 10° in 10° of the lever.

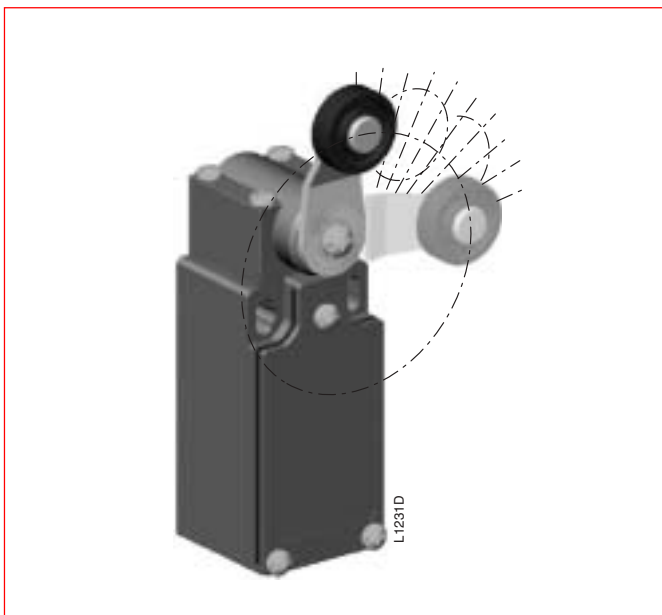

- Lever round turning.

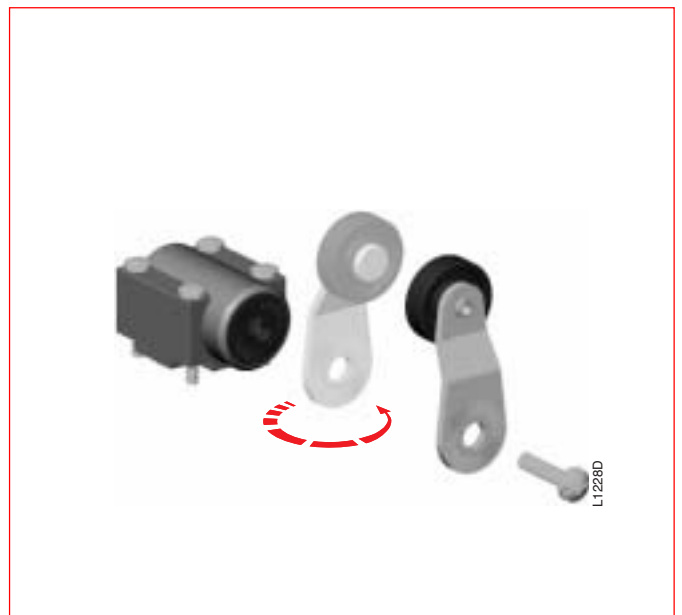

LS72P..., LS73P... and LS75P... Limit Switches

Double Insulation – Plastic Casing IP65

Applications

Easy to use, electromechanical limit switches offer specific qualities:

- Visible operation.
- Able to switch strong currents (10 A conventional thermal current).
- Electrically separated contacts (Zb shape).
- Contact blocks with positive opening operation of the "N.C." normally closed contact(s) (symbol ⊖).
- Precise operating points (consistency).
- Immune to electromagnetic disturbances.

They are exceptional detection devices thanks to these characteristics:

- Presence/absence.
- Positioning and travel limit.
- Objects passing/counting.

Description

Limit switches, which are made of fibre-glass reinforced UL-V0 thermoplastic material, offer double insulation \square and a degree of protection IP65.

The casing comes in 1 dimension: LS72P..., LS73P..., LS75P... 60 mm width.

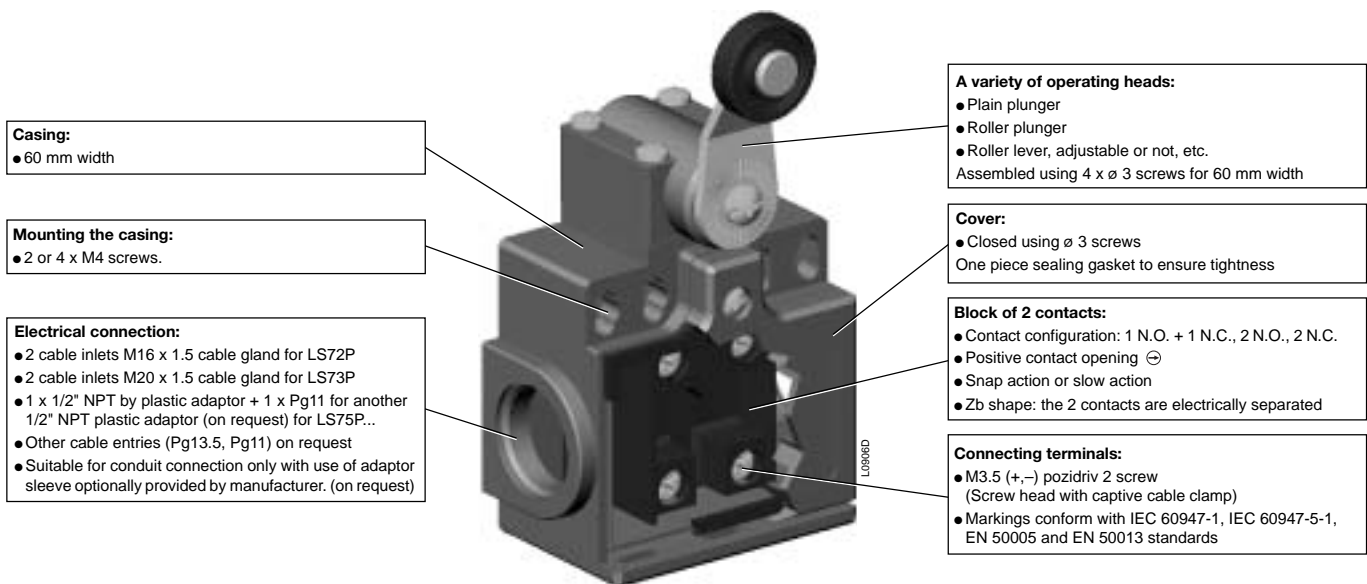

Type

Example:

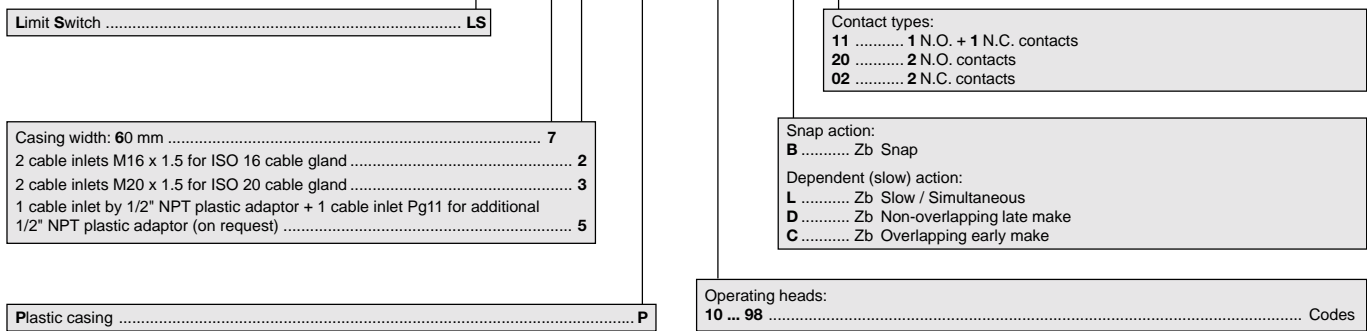

>> Travel and Operation Diagrams page 8 >> General Technical Data page 9	>> Terminology page 50 >> Ordering Details pages 52...67
---	---

LS72P..., LS73P... and LS75P... Limit Switches

Double Insulation – Plastic Casing IP65

Implementation

- Head orientation.

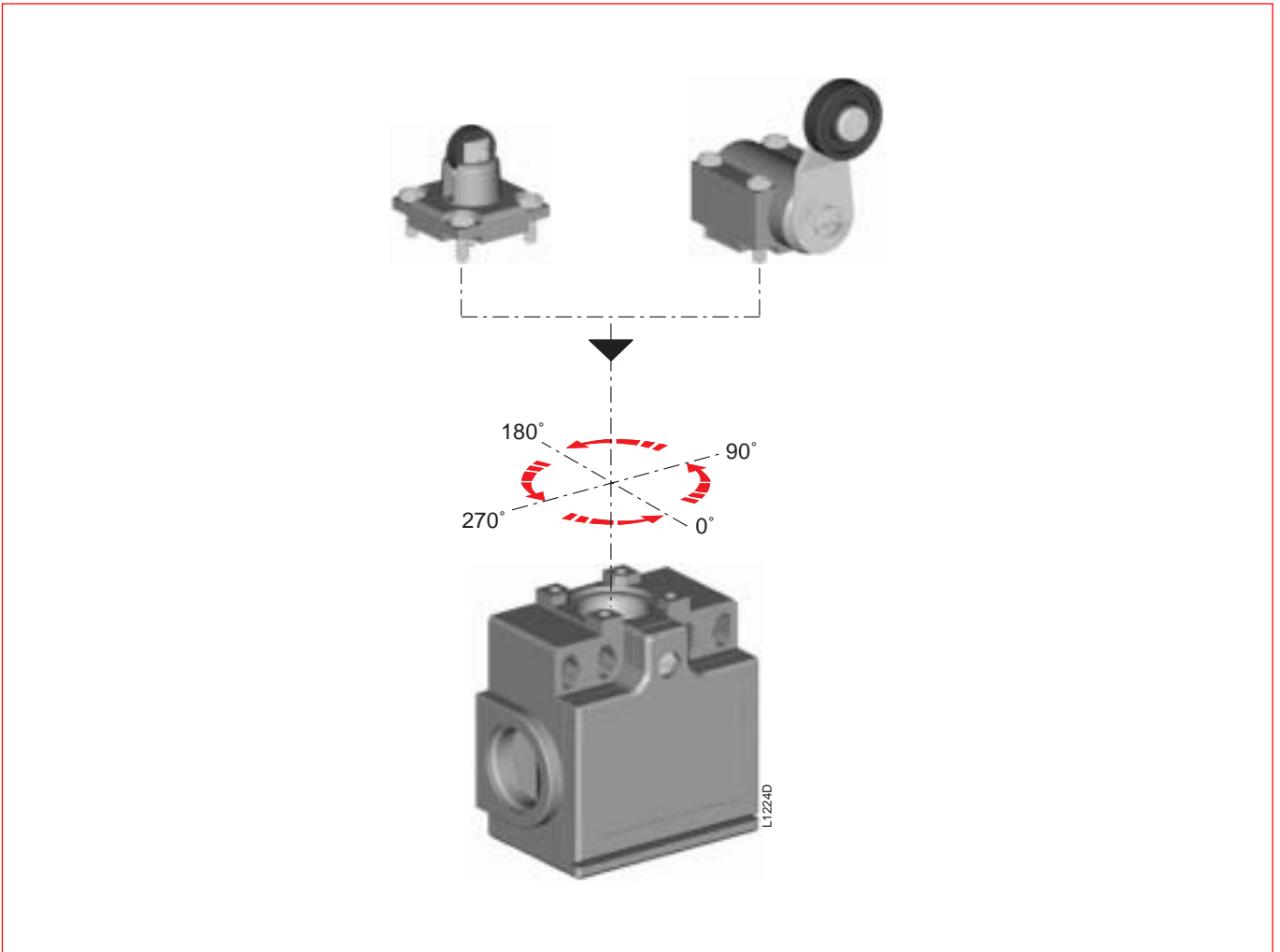

- Free position adjustment 10° in 10° of the lever.

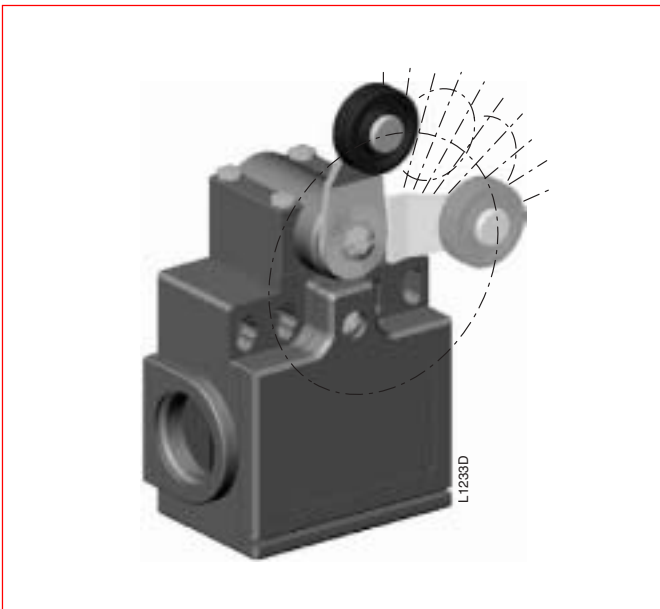

- Lever round turning.



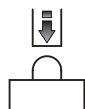
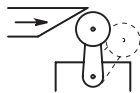
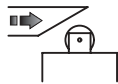
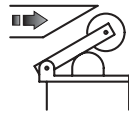
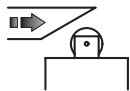
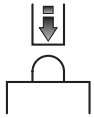
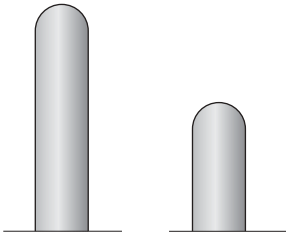

Limit Switches Plastic or Metal Casing

Technical Data

General Technical Data

	Plastic Casing	Metal Casing
Standards	IEC 60947-1, IEC 60947-5-1, EN 60947-1, EN 60947-5-1, UL 508 and CSA C22-2 n° 14	
Certifications - Approvals	UL - CSA	
Air temperature near the device		
– during operation	– 25 ... + 70	– 25 ... + 70
– for storage	– 30 ... + 80	– 30 ... + 80
Climatic withstand	According to IEC 68-2-3 and salty mist according to IEC 68-2-11	
Mounting positions	All positions are authorized	
Shock withstand (according to IEC 68-2-27 and EN 60068-2-27) g	50g* (1/2 sinusoidal shock for 11 ms) no change in contact position	
Resistance to vibrations (acc. to IEC 68-2-6 and EN 60068-2-6) g	25g (10 ... 500 Hz) no change in position of contacts greater than 100 μs	
Protection against electrical shocks (acc. to IEC 536)	Class II	Class I
Degree of protection (according to IEC 529 and EN 60529)	IP65	IP66 **
Consistency (measured over 1 million operations)	0.1 mm (upon closing point)	0.1 mm (upon closing point)
Minimum actuation speed	m/s Slow action contacts 0.060 / Snap action contacts 0.001	

Electrical Data

Rated insulation voltage U_i			
– according to IEC 60947-1 and EN 60947-1	V	500 (degree of pollution 3)	400 (degree of pollution 3)
– according to UL 508, CSA C22-2 n° 14	V	600	300
Rated impulse withstand voltage U_{imp}	kV	6	
(according to IEC 60947-1 and EN 60947-1)			
Conventional enclosed thermal current I_{the}	A	10	
(according to IEC 60947-5-1 and EN 60947-5-1) $\theta \leq 40^\circ\text{C}$			
Short-circuit protection	A	10	
gG type fuses			
Rated operational current			
I_e / AC-15 – acc. to IEC 60947-5-1			
24 V - 50/60 Hz	A	10	
130 V - 50/60 Hz	A	5.5	
230 V - 50/60 Hz	A	3.1	
240 V - 50/60 Hz	A	3	
400 V - 50/60 Hz	A	1.8	
– acc. to UL 508, CSA C22 n° 14		A 600	A 300
I_e / DC-13 – acc. to IEC 60947-5-1			
24 V - d.c.	A	2.8	
110 V - d.c.	A	0.6	
250 V - d.c.	A	0.27	
– acc. to UL 508, CSA C22 n° 14		Q 600	Q 300
Positivity		Contacts with positive opening operation as per IEC 60947-5-1 chapter 3 and EN 60947-5-1	
Resistance between contacts	mΩ	25	
Mechanical durability	Millions of operations	15 } LS7xP { 10...12 ; 30...38 10 } { 13 ; 41...46 ; 51...53 ; 71...78 > 5 } { 91...92 ; 98	15 } 3x } M { 11...12 ; 31...38 10 } LS } { 13 ; 41...46 ; 51...55 ; 61...78 > 5 } 7x } { 14 ; 91...92 ; 98
Electrical durability (according to IEC 60947-5-1 appendice C)		Utilization categories AC-15 and DC-13 (see curves and values below)	
– max. switching frequency	Cycles/h	3600	
– load factor		0.5	

* Except for LS32/33/35M42, M52 and M55 - LS72/73/75M42, M52 and M55 - LS72/73/75P42, P52 and P55: 25g

** Except for LS32/33/35M52, M55, M73, M74 and M92 - LS72/73/75M52, M55, M73, M74 and M92 : the degree of protection is IP65.

Electrical durability for AC-15 utilization category

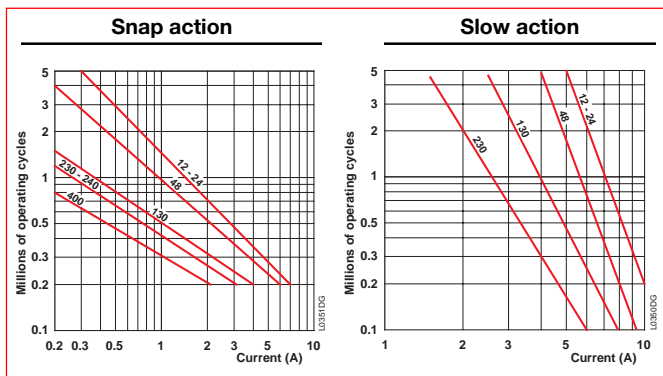

Electrical durability for DC-13 utilization category

	Snap action	Slow action
Power breaking for a durability of 5 million operating cycles		
Voltage 24 V	9.5 W	12 W
Voltage 48 V	6.8 W	9 W
Voltage 110 V	3.6 W	6 W

>> Ordering Details pages 52...76

LS32M..., LS33M..., LS35M... and LS72M..., LS73M..., LS75M... Limit Switches

Metal Casing IP66 - 30 mm and 60 mm width

Main Technical Data (continued)

Tightening Torques

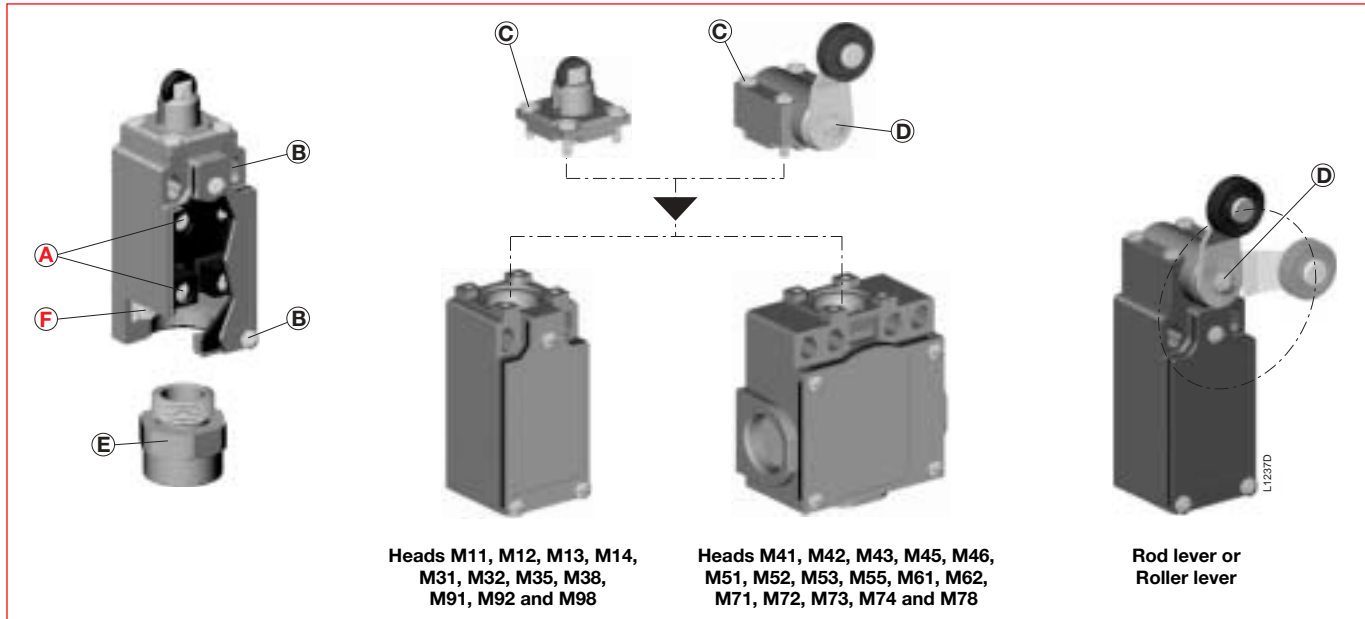

	A and F		B		C		D		E	
	Connecting terminals for: - Contact block (A) - Protective conductor (F)		Closing the cover		Assembling the operating head		Assembling or adjusting: - Rod lever - Roller lever		Cable inlet by 1/2" NPT metal adaptor *	
Screws	M3.5 ± pozidriv 2		M3 ± pozidriv 1		M3 ± pozidriv 1		M3 ± pozidriv 1		-	
Tightening torque	Recommended N.m / lb.in	Max. N.m	Recommended N.m / lb.in	Max. N.m	Recommended N.m / lb.in	Max. N.m	Recommended N.m / lb.in	Max. N.m	Recommended N.m / lb.in	Max. N.m
Limit switches										
LS32M11 ... M38	0.8 / 7	0.9	0.5 / 4.3	0.8	0.5 / 4.3	0.8	-	-	-	-
LS32M41 ... M78	0.8 / 7	0.9	0.5 / 4.3	0.8	0.5 / 4.3	0.8	0.5 / 4.3	0.8	-	-
LS32M91 ... M98	0.8 / 7	0.9	0.5 / 4.3	0.8	0.5 / 4.3	0.8	-	-	-	-
LS33M11 ... M38	0.8 / 7	0.9	0.5 / 4.3	0.8	0.5 / 4.3	0.8	-	-	-	-
LS33M41 ... M78	0.8 / 7	0.9	0.5 / 4.3	0.8	0.5 / 4.3	0.8	0.5 / 4.3	0.8	-	-
LS33M91 ... M98	0.8 / 7	0.9	0.5 / 4.3	0.8	0.5 / 4.3	0.8	-	-	-	-
LS35M11 ... M38	0.8 / 7	0.9	0.5 / 4.3	0.8	0.5 / 4.3	0.8	-	-	17 / 150	18
LS35M41 ... M78	0.8 / 7	0.9	0.5 / 4.3	0.8	0.5 / 4.3	0.8	0.5 / 4.3	0.8	17 / 150	18
LS35M91 ... M98	0.8 / 7	0.9	0.5 / 4.3	0.8	0.5 / 4.3	0.8	-	-	17 / 150	18
LS72M11 ... M38	0.8 / 7	0.9	0.5 / 4.3	0.8	0.5 / 4.3	0.8	-	-	-	-
LS72M41 ... M78	0.8 / 7	0.9	0.5 / 4.3	0.8	0.5 / 4.3	0.8	0.5 / 4.3	0.8	-	-
LS72M91 ... M98	0.8 / 7	0.9	0.5 / 4.3	0.8	0.5 / 4.3	0.8	-	-	-	-
LS73M11 ... M38	0.8 / 7	0.9	0.5 / 4.3	0.8	0.5 / 4.3	0.8	-	-	-	-
LS73M41 ... M78	0.8 / 7	0.9	0.5 / 4.3	0.8	0.5 / 4.3	0.8	0.5 / 4.3	0.8	-	-
LS73M91 ... M98	0.8 / 7	0.9	0.5 / 4.3	0.8	0.5 / 4.3	0.8	-	-	-	-
LS75M11 ... M38	0.8 / 7	0.9	0.5 / 4.3	0.8	0.5 / 4.3	0.8	-	-	17 / 150	18
LS75M41 ... M78	0.8 / 7	0.9	0.5 / 4.3	0.8	0.5 / 4.3	0.8	0.5 / 4.3	0.8	17 / 150	18
LS75M91 ... M98	0.8 / 7	0.9	0.5 / 4.3	0.8	0.5 / 4.3	0.8	-	-	17 / 150	18

Connecting data of contact blocks

Connecting terminals	M3.5 (+, -) pozidriv 2 screw with cable clamp	
Connecting capacity	0.5 mm ² / AWG 20 to 2.5 mm ² / AWG 14	
Terminal marking	According to EN 50013	

* This type of adaptor can be used with direct conduit connections.

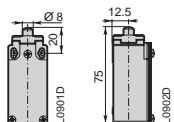

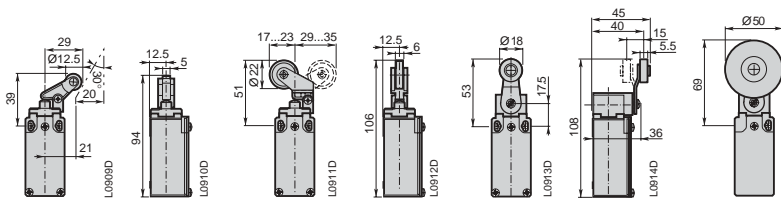
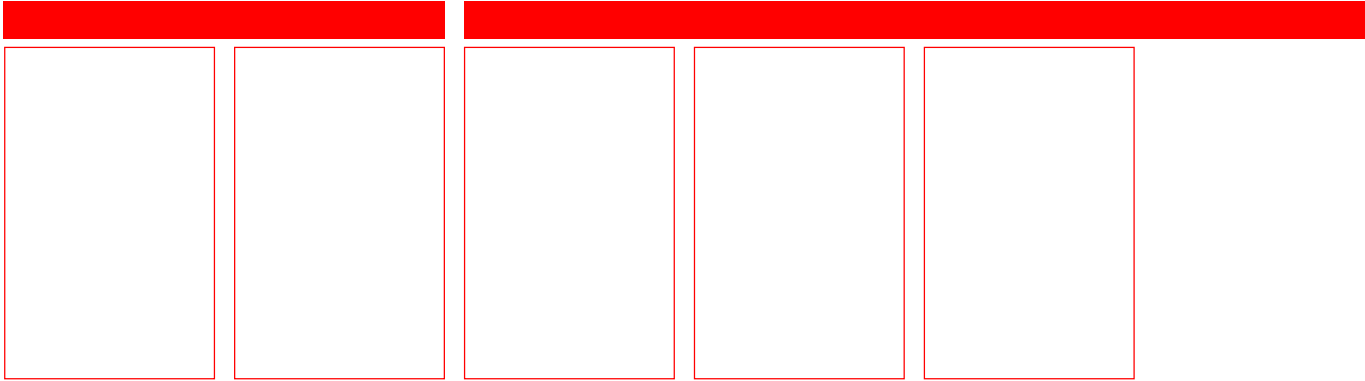

Actuator



	Adjustable ø18 roller lever	Adjustable ø50 rubber roller lever	Adjustable lever with ø50 rubber roller	Adjustable ø3 rod lever
Conformity / \rightarrow (N.C. contact with positive opening operation)	-	-	-	-
Maximum actuation speed	1.5 m/s	1.5 m/s	1.5 m/s	1.5 m/s
Min. force / torque: - actuation	0.1 N.m	0.1 N.m	0.1 N.m	0.1 N.m
- positive opening operation	0.32 N.m	0.32 N.m	0.32 N.m	0.32 N.m

Additional Technical Data

Type and Order code to be completed with code <input type="checkbox"/>		Metal roller <input type="checkbox"/> 3 Plastic roller <input type="checkbox"/> 1	-	-	Metal rod <input type="checkbox"/> 1 Fibre-glass rod <input type="checkbox"/> 2
Snap action contacts	Type Order code	LS32M5 <input type="checkbox"/> B11 1SBV01195 <input type="checkbox"/> R1211	LS32M52B11 1SBV011952R1211	LS32M55B11 1SBV011955R1211	LS32M7 <input type="checkbox"/> B11 1SBV01197 <input type="checkbox"/> R1211
	Operation diagram				
Non-overlapping Slow action contacts	Type Order code	LS32M5 <input type="checkbox"/> D11 1SBV01195 <input type="checkbox"/> R1411	LS32M52D11 1SBV011952R1411	LS32M55D11 1SBV011955R1411	LS32M7 <input type="checkbox"/> D11 1SBV01197 <input type="checkbox"/> R1411
	Operation diagram				
Overlapping Slow action contacts	Type Order code	LS32M5 <input type="checkbox"/> C11 1SBV01195 <input type="checkbox"/> R1511	LS32M52C11 1SBV011952R1511	LS32M55C11 1SBV011955R1511	LS32M7 <input type="checkbox"/> C11 1SBV01197 <input type="checkbox"/> R1511
	Operation diagram				
Slow action contacts	Type Order code	LS32M5 <input type="checkbox"/> L02 1SBV01195 <input type="checkbox"/> R1302	LS32M52L02 1SBV011952R1302	LS32M55L02 1SBV011955R1302	LS32M7 <input type="checkbox"/> L02 1SBV01197 <input type="checkbox"/> R1302
	Operation				μ

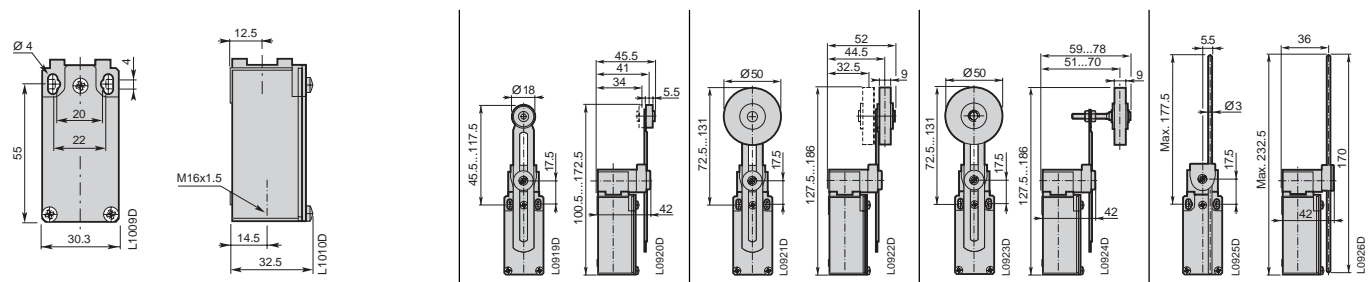

LS32M... Limit Switches

Metal Casing IP66 - 30 mm Width

1 Cable Inlet M16 x 1.5 for ISO 16 Cable Gland

Fully Directional Translation Movement

Multidirectional

Pull Action

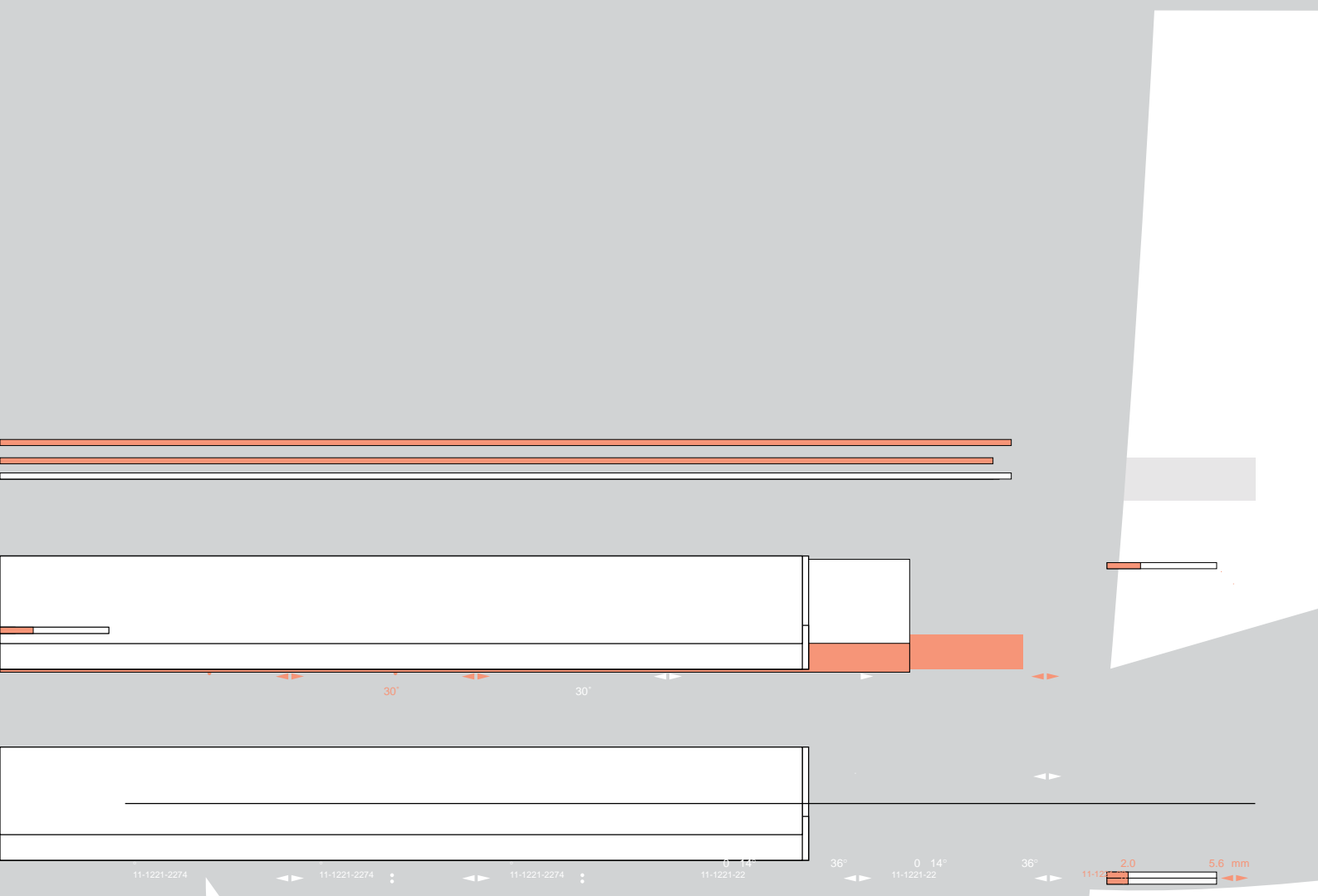

LS32M73L20	LS32M74L20	LS32M78L20	LS32M91L20	LS32M92L20	LS32M98L20-A1SBV01197
18 13-1423-24	74 13-1423-24	18 13-1423-24	74 13-1423-24	36 13-1423-24	36 13-1423-24
46	46	46	46	46	46
17 11-1221-2211-1221-22	17 30 11-1221-2211-1221-22	17 30 11-1221-2211-1221-22	17 30 11-1221-2211-1221-22	22 11-1221-2211-1221-22	12 22 11-1221-2211-1221-22
0	0	0	0	0	0
0.255	0.255	0.240	0.180	0.185	0.215

Special heads, accessories and special contact arrangement or particular function: please consult us.

Tearing withstand of
 - operating head: 200 daN
 - ring: 40 daN

LS33M... Limit Switches

Metal Casing IP66 - 30 mm Width
1 Cable Inlet M20 x 1.5 for ISO 20 Cable Gland

Movement to be detected:

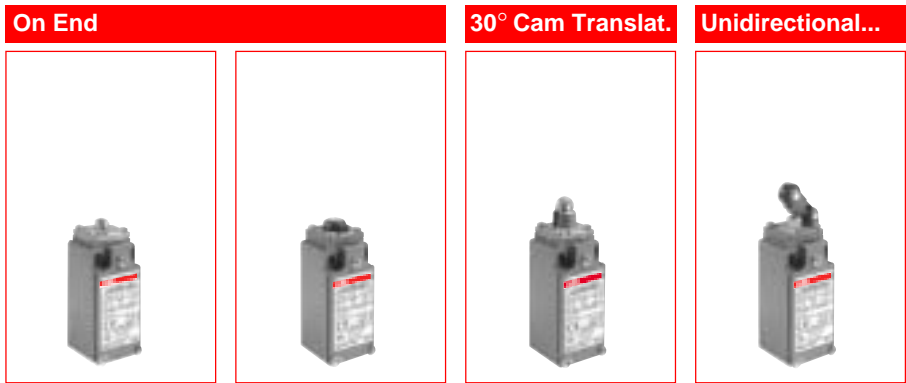



Actuator

	Plain plunger	Plain plunger with dust protection cup	Roller plunger	Plastic roller lever on plunger
Conformity / \odot (N.C. contact with positive opening operation)	EN 50047 (B shape) \odot	EN 50047 (B shape) \odot	EN 50047 (C shape) \odot	EN 50047 (E shape) \odot
Maximum actuation speed	0.5 m/s	0.5 m/s	0.3 m/s	1 m/s
Min. force / torque: - actuation	15 N	15 N	12 N	7 N
- positive opening operation	45 N	45 N	41 N	24 N

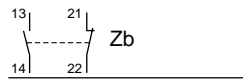
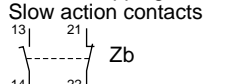
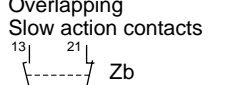
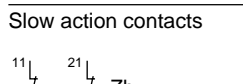
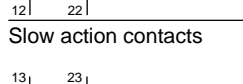
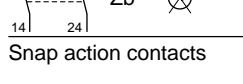
Additional Technical Data

Type and Order code to be completed with code <input type="checkbox"/>	Metal plunger <input type="checkbox"/> Plastic plunger <input checked="" type="checkbox"/>	Metal plunger <input checked="" type="checkbox"/> Plastic plunger <input checked="" type="checkbox"/>	Metal roller <input checked="" type="checkbox"/> Plastic roller <input checked="" type="checkbox"/>	Metal plunger <input checked="" type="checkbox"/> Plastic plunger <input checked="" type="checkbox"/>
Snap action contacts 	LS33M1 <input type="checkbox"/> B11 1SBV01381 <input type="checkbox"/> R1211 0 1.7 2.7 4.3 5.6 mm	LS33M1 <input checked="" type="checkbox"/> B11 1SBV01381 <input checked="" type="checkbox"/> R1211 0 1.7 2.7 4.3 5.6 mm	LS33M1 <input type="checkbox"/> B11 1SBV01381 <input type="checkbox"/> R1211 0 3.0 4.8 7.7 9.6 mm	LS33M3 <input type="checkbox"/> B11 1SBV01383 <input type="checkbox"/> R1211 0 4.9 9.0 14.5 21.0 mm
Non-overlapping Slow action contacts 	LS33M1 <input type="checkbox"/> D11 1SBV01381 <input type="checkbox"/> R1411 0 1.9 3.5 5.6 mm	LS33M1 <input checked="" type="checkbox"/> D11 1SBV01381 <input checked="" type="checkbox"/> R1411 0 1.9 3.5 5.6 mm	LS33M1 <input type="checkbox"/> D11 1SBV01381 <input type="checkbox"/> R1411 0 3.4 6.3 9.6 mm	LS33M3 <input type="checkbox"/> D11 1SBV01383 <input type="checkbox"/> R1411 0 6.0 10.5 21.0 mm
Overlapping Slow action contacts 	LS33M1 <input type="checkbox"/> C11 1SBV01381 <input type="checkbox"/> R1511 0 3.2 4.8 5.6 mm	LS33M1 <input checked="" type="checkbox"/> C11 1SBV01381 <input checked="" type="checkbox"/> R1511 0 3.2 4.8 5.6 mm	LS33M1 <input type="checkbox"/> C11 1SBV01381 <input type="checkbox"/> R1511 0 5.7 8.6 9.6 mm	LS33M3 <input type="checkbox"/> C11 1SBV01383 <input type="checkbox"/> R1511 0 10.2 14.6 21.0 mm
Slow action contacts 	LS33M1 <input type="checkbox"/> L02 1SBV01381 <input type="checkbox"/> R1302 0 1.9 3.5 5.6 mm	LS33M1 <input checked="" type="checkbox"/> L02 1SBV01381 <input checked="" type="checkbox"/> R1302 0 1.9 3.5 5.6 mm	LS33M1 <input type="checkbox"/> L02 1SBV01381 <input type="checkbox"/> R1302 0 3.4 6.3 9.6 mm	LS33M3 <input type="checkbox"/> L02 1SBV01383 <input type="checkbox"/> R1302 0 5.7 10.2 21.0 mm
Slow action contacts 	LS33M1 <input type="checkbox"/> L20 1SBV01381 <input type="checkbox"/> R1320 0 1.8 5.6 mm	LS33M1 <input checked="" type="checkbox"/> L20 1SBV01381 <input checked="" type="checkbox"/> R1320 0 1.8 5.6 mm	LS33M1 <input type="checkbox"/> L20 1SBV01381 <input type="checkbox"/> R1320 0 3.2 9.6 mm	LS33M3 <input type="checkbox"/> L20 1SBV01383 <input type="checkbox"/> R1320 0 5.3 21.0 mm
Snap action contacts 	LS33M1 <input type="checkbox"/> B02 1SBV01381 <input type="checkbox"/> R1202 0 1.8 2.8 4.4 5.6 mm	LS33M1 <input checked="" type="checkbox"/> B02 1SBV01381 <input checked="" type="checkbox"/> R1202 0 1.8 2.8 4.4 5.6 mm	LS33M1 <input type="checkbox"/> B02 1SBV01381 <input type="checkbox"/> R1202 0 3.2 5.0 7.9 9.6 mm	LS33M3 <input type="checkbox"/> B02 1SBV01383 <input type="checkbox"/> R1202 0 5.1 8.6 13.1 21.0 mm
Weight (packing per unit)	kg 0.180	0.180	0.185	0.175

Special heads, accessories and special contact arrangement or particular function: please consult us.

 Closed contact /  Open contact

Dimensions (in mm)

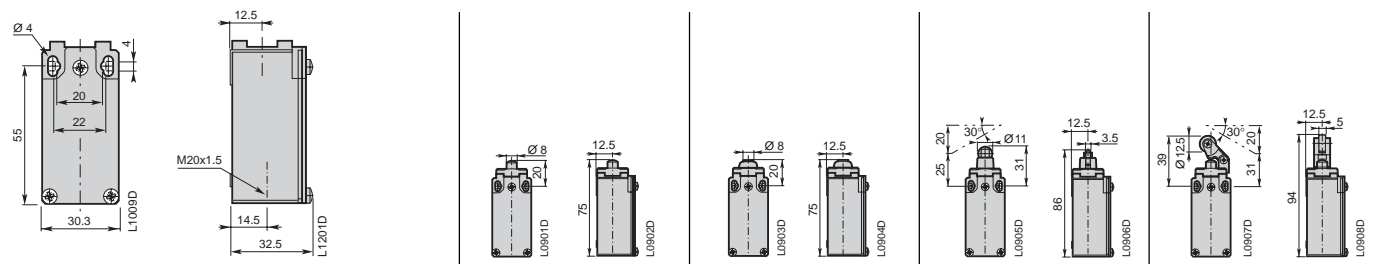

>> Description, Travel and Technical Data pages 4..11

>> Accessories page 48

>> Utilization Precautions page 51

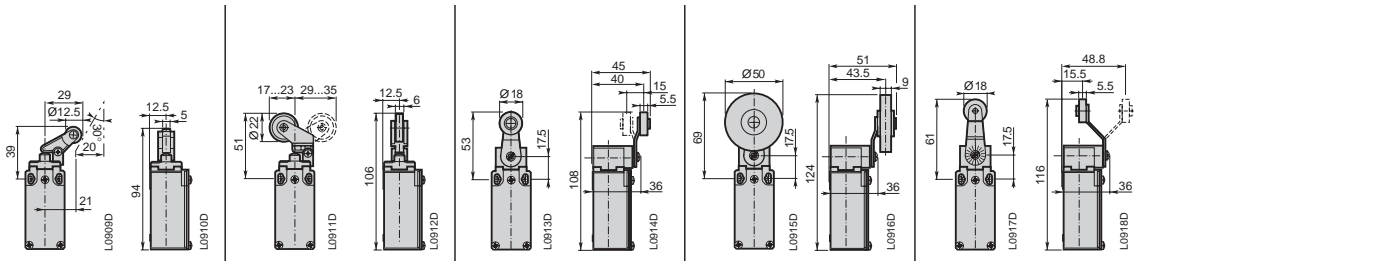
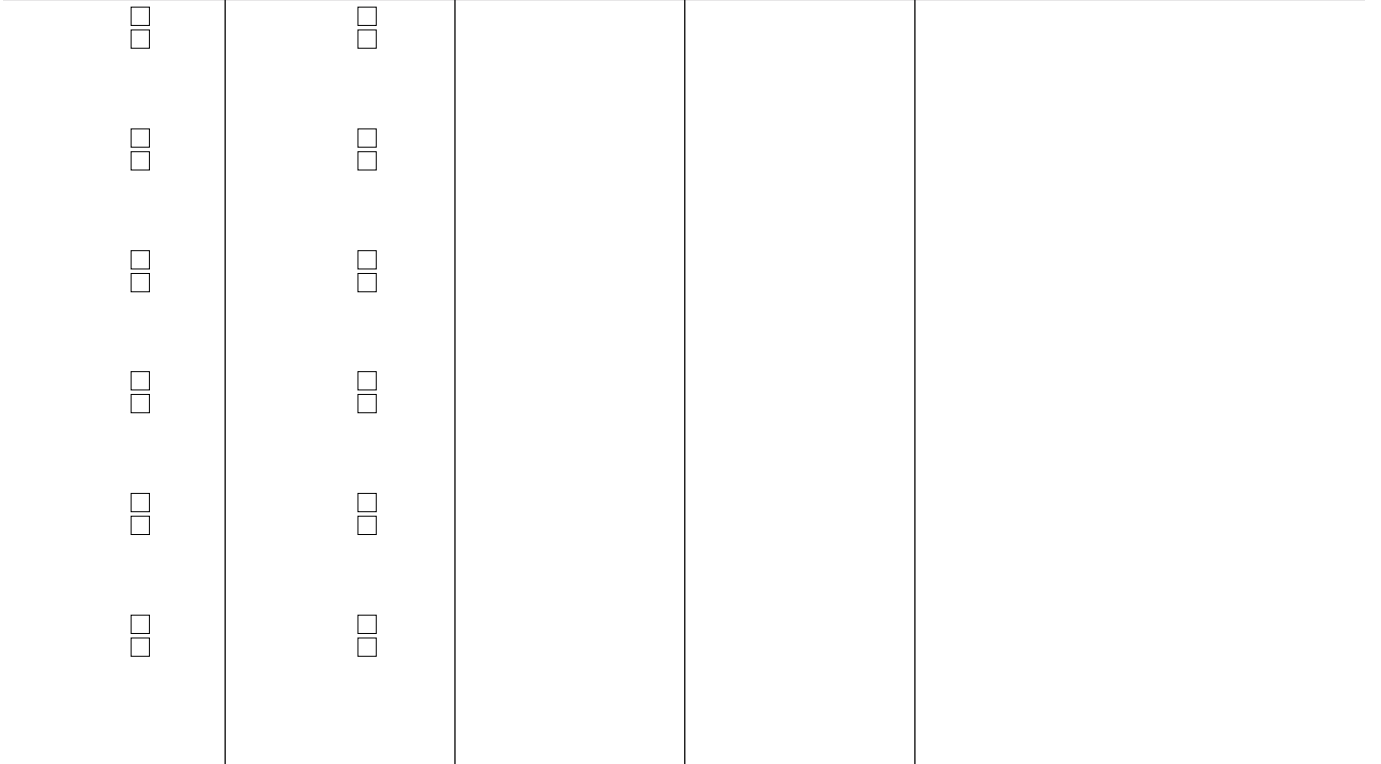
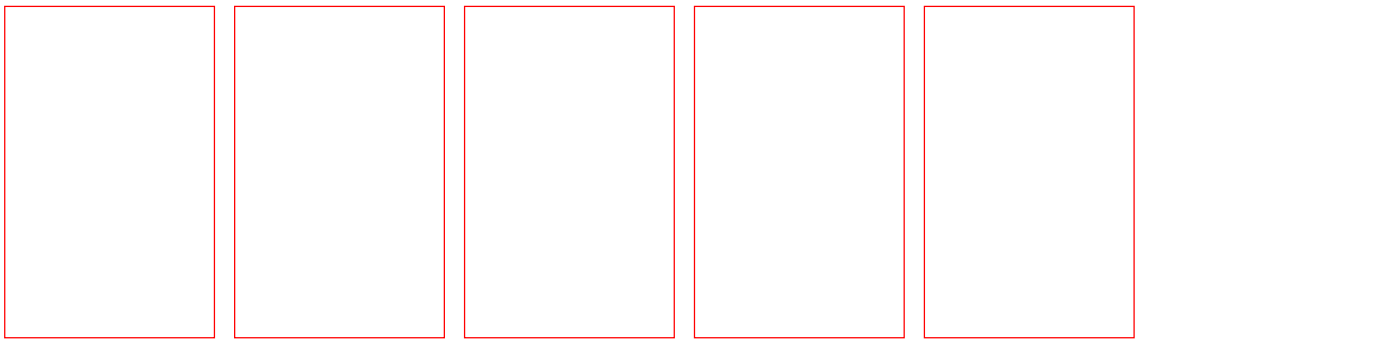

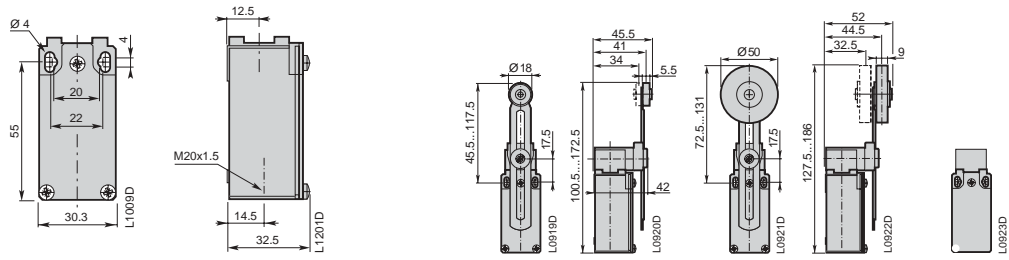
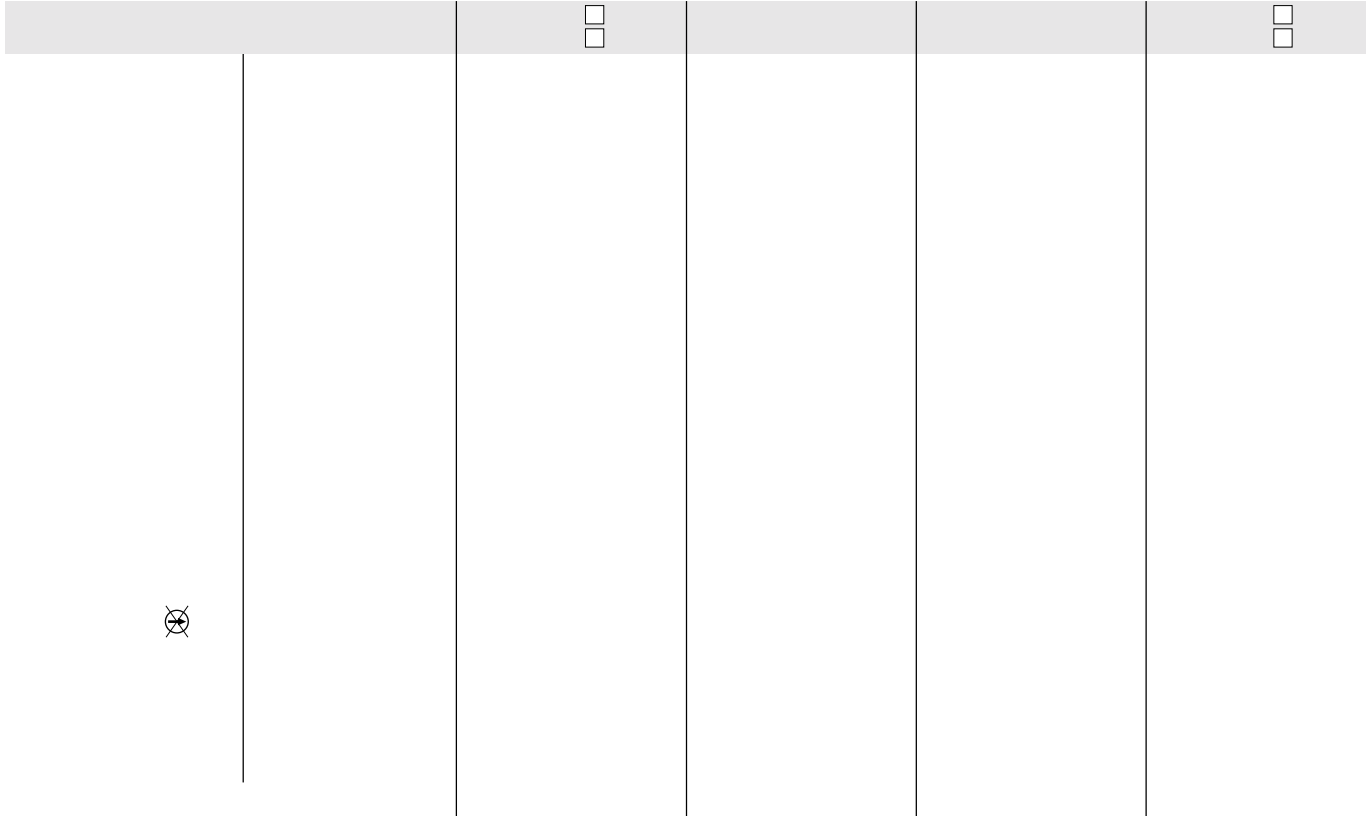
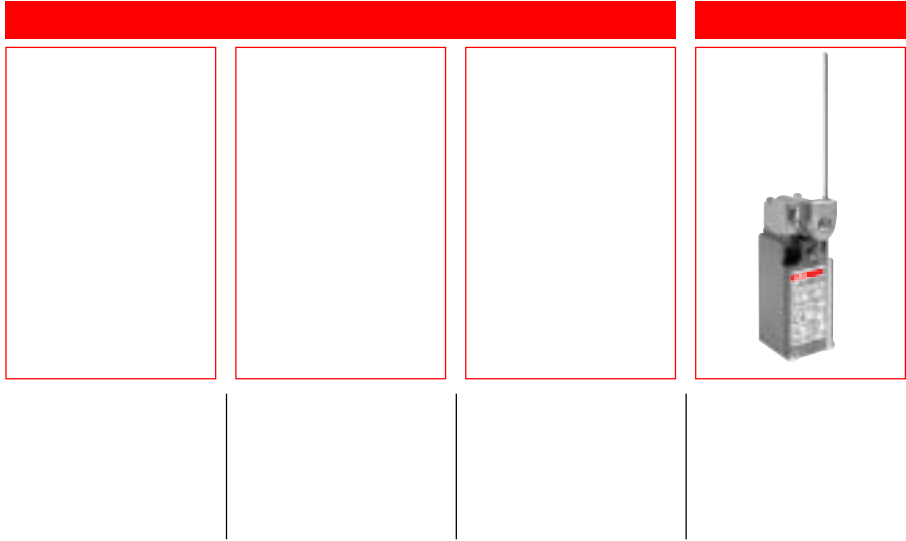

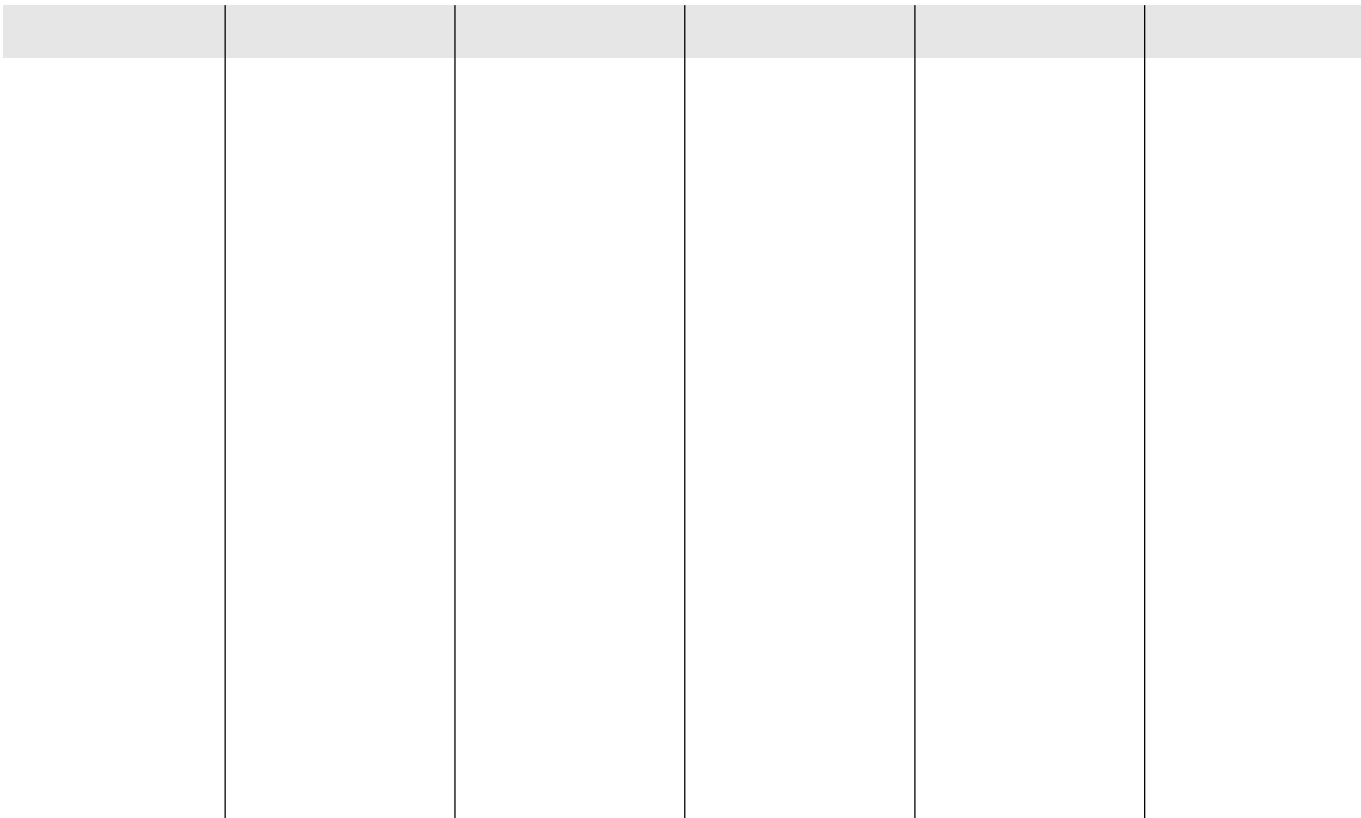
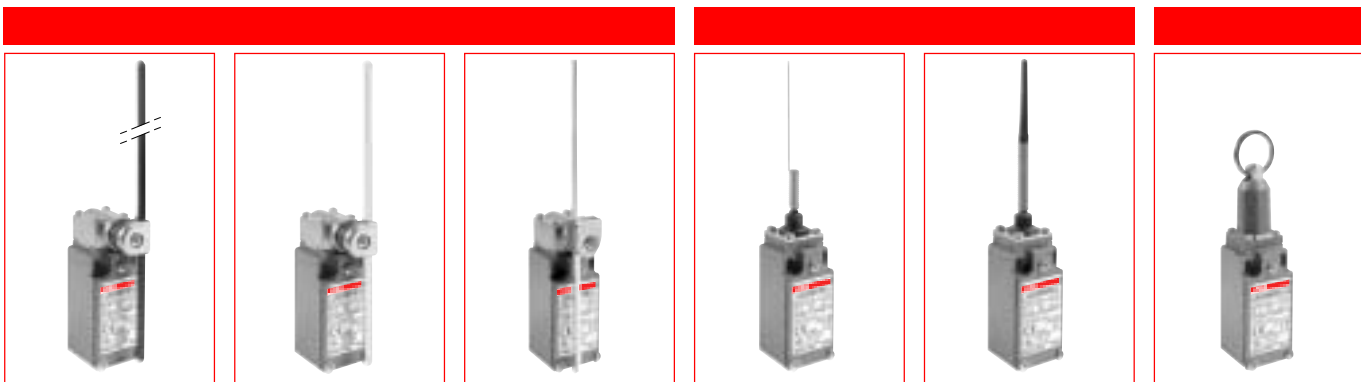

□

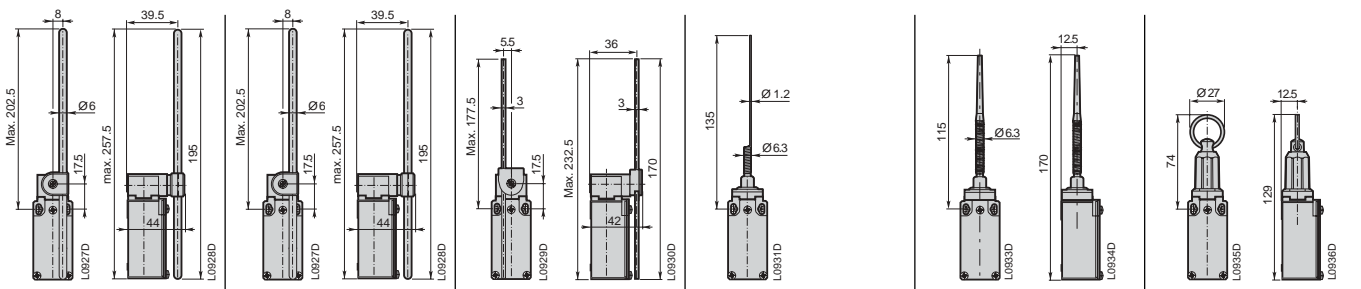

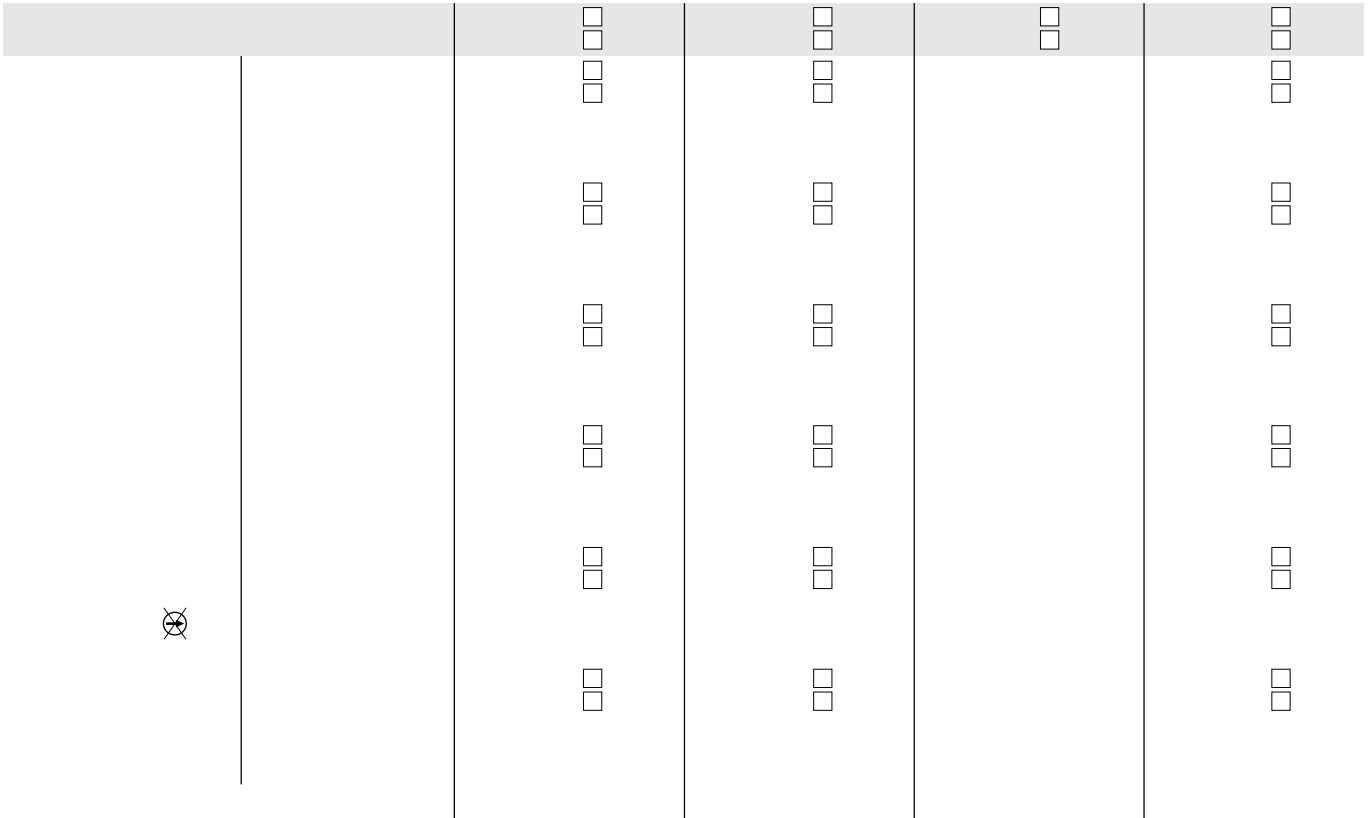
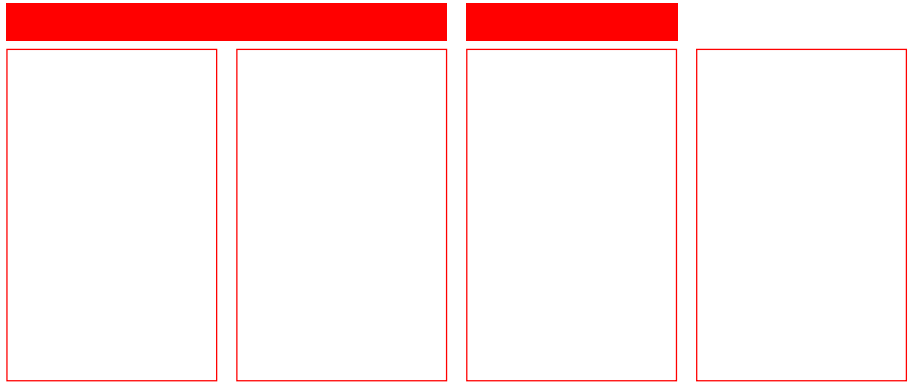







Ø8 12.5

LS35M... Limit Switches

Metal Casing IP66 - 30 mm Width
1 Cable Inlet for 1/2" NPT Cable Gland

Unidirectional 30° Cam Translation

30° Cam Translation Movement

					
Plastic roller lever on plunger	Adjustable plastic roller lever on plunger	ø18 roller lever	ø50 rubber roller lever	ø18 plastic roller with bent lever	ø18 steel roller with bent lever
1 m/s 7 N 24 N	1 m/s 7 N 24 N	EN 50047 (A shape) 1.5 m/s 0.1 N.m 0.32 N.m	1.5 m/s 0.1 N.m 0.32 N.m	1.5 m/s 0.1 N.m 0.32 N.m	1.5 m/s 0.1 N.m 0.32 N.m

Metal plunger <input type="checkbox"/> Plastic plunger <input checked="" type="checkbox"/>	Metal plunger <input type="checkbox"/> Plastic plunger <input checked="" type="checkbox"/>	Metal roller <input type="checkbox"/> Plastic roller <input type="checkbox"/>	-	-	-
LS35M3 <input type="checkbox"/> B11 1SBV01373 <input type="checkbox"/> R1211	LS35M3 <input type="checkbox"/> B11 1SBV01373 <input type="checkbox"/> R1211	LS35M4 <input type="checkbox"/> B11 1SBV01374 <input type="checkbox"/> R1211	LS35M42B11 1SBV013742R1211	LS35M45B11 1SBV013745R1211	LS35M46B11 1SBV013746R1211
0 4.9 9.0 14.5 21.0 mm	0 8.8 15.0 23.2 32.0 mm	0 17° 31° 47° 74°	0 17° 31° 47° 74°	0 17° 31° 47° 74°	0 17° 31° 47° 74°
21-22 13-14	21-22 13-14	21-22 13-14	21-22 13-14	21-22 13-14	21-22 13-14
LS35M3 <input type="checkbox"/> D11 1SBV01373 <input type="checkbox"/> R1411	LS35M3 <input type="checkbox"/> D11 1SBV01373 <input type="checkbox"/> R1411	LS35M4 <input type="checkbox"/> D11 1SBV01374 <input type="checkbox"/> R1411	LS35M42D11 1SBV 01 3742 R1411	LS35M45D11 1SBV013745R1411	LS35M46D11 1SBV013746R1411
0 6.0 10.5 21.0 mm	0 10.6 18.5 32.0 mm	0 21° 37° 74°	0 21° 37° 74°	0 21° 37° 74°	0 21° 37° 74°
21-22 13-14	21-22 13-14	21-22 13-14	21-22 13-14	21-22 13-14	21-22 13-14
LS35M3 <input type="checkbox"/> C11 1SBV01373 <input type="checkbox"/> R1511	LS35M3 <input type="checkbox"/> C11 1SBV01373 <input type="checkbox"/> R1511	LS35M4 <input type="checkbox"/> C11 1SBV01374 <input type="checkbox"/> R1511	LS35M42C11 1SBV013742R1511	LS35M45C11 1SBV013745R1511	LS35M46C11 1SBV013746R1511
0 10.2 14.6 21.0 mm	0 16.8 25.1 32.0 mm	0 35° 51° 74°	0 35° 51° 74°	0 35° 51° 74°	0 35° 51° 74°
21-22 13-14	21-22 13-14	21-22 13-14	21-22 13-14	21-22 13-14	21-22 13-14
LS35M3 <input type="checkbox"/> L02 1SBV01373 <input type="checkbox"/> R1302	LS35M3 <input type="checkbox"/> L02 1SBV01373 <input type="checkbox"/> R1302	LS35M4 <input type="checkbox"/> L02 1SBV01374 <input type="checkbox"/> R1302	LS35M42L02 1SBV013742R1302	LS35M45L02 1SBV013745R1302	LS35M46L02 1SBV013746R1302
0 5.7 10.2 21.0 mm	0 9.6 17.8 32.0 mm	0 19° 37° 74°	0 19° 37° 74°	0 19° 37° 74°	0 19° 37° 74°
11-12 21-22	11-12 21-22	11-12 21-22	11-12 21-22	11-12 21-22	11-12 21-22
LS35M3 <input type="checkbox"/> L20 1SBV01373 <input type="checkbox"/> R1320	LS35M3 <input type="checkbox"/> L20 1SBV01373 <input type="checkbox"/> R1320	LS35M4 <input type="checkbox"/> L20 1SBV01374 <input type="checkbox"/> R1320	LS35M42L20 1SBV013742R1320	LS35M45L20 1SBV013745R1320	LS35M46L20 1SBV013746R1320
0 5.3 21.0 mm	0 9.2 32.0 mm	0 18° 74°	0 18° 74°	0 18° 74°	0 18° 74°
13-14 23-24	13-14 23-24	13-14 23-24	13-14 23-24	13-14 23-24	13-14 23-24
LS35M3 <input type="checkbox"/> B02 1SBV01373 <input type="checkbox"/> R1202	LS35M3 <input type="checkbox"/> B02 1SBV01373 <input type="checkbox"/> R1202	LS35M4 <input type="checkbox"/> B02 1SBV01374 <input type="checkbox"/> R1202	LS35M42B02 1SBV013742R1202	LS35M45B02 1SBV013745R1202	LS35M46B02 1SBV013746R1202
0 5.1 8.6 13.1 21.0 mm	0 8.8 14.6 22.8 32.0 mm	0 17° 30° 46° 74°	0 17° 30° 46° 74°	0 17° 30° 46° 74°	0 17° 30° 46° 74°
11-12 21-22	11-12 21-22	11-12 21-22	11-12 21-22	11-12 21-22	11-12 21-22
0.175	0.180	0.235	0.255	0.250	0.255

Special heads, accessories and special contact arrangement or particular function: please consult us.

■ Closed contact / Open contact

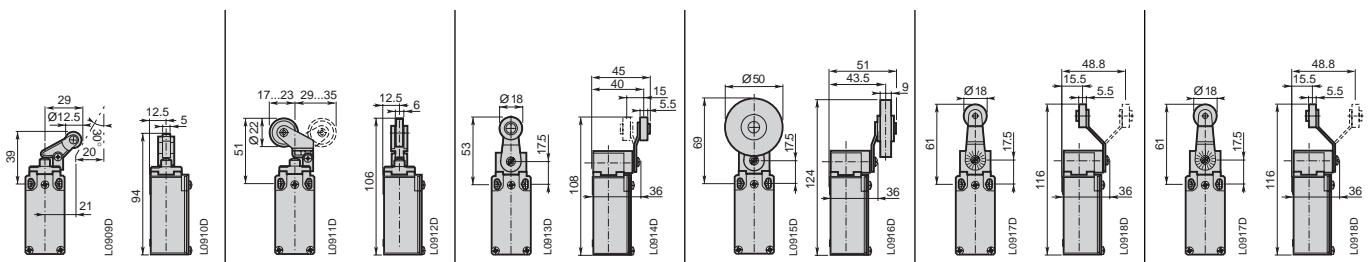

>> Description, Travel and Technical Data pages 4...11

>> Accessories page 48

>> Utilization Precautions page 51

Actuator



	Adjustable ø18 roller lever	Adjustable ø50 rubber roller lever	Adjustable lever with ø50 rubber roller	Adjustable ø3 rod lever
Conformity / \ominus (N.C. contact with positive opening operation)	-	-	-	-
Maximum actuation speed	1.5 m/s	1.5 m/s	1.5 m/s	1.5 m/s
Min. force / torque: - actuation	0.1 N.m	0.1 N.m	0.1 N.m	0.1 N.m
- positive opening operation	0.32 N.m	0.32 N.m	0.32 N.m	0.32 N.m

Additional Technical Data

Type and Order code to be completed with code <input type="checkbox"/>		Metal roller <input type="checkbox"/> 3 Plastic roller <input type="checkbox"/> 1	-	-	Metal rod <input type="checkbox"/> 1 Fibre-glass rod <input type="checkbox"/> 2
Snap action contacts	Type Order code	LS35M5 <input type="checkbox"/> B11 1SBV01375 <input type="checkbox"/> R1211	LS35M52B11 1SBV013752R1211	LS35M55B11 1SBV013755R1211	LS35M7 <input type="checkbox"/> B11 1SBV01377 <input type="checkbox"/> R1211
	Operation diagram				
Non-overlapping Slow action contacts	Type Order code	LS35M5 <input type="checkbox"/> D11 1SBV01375 <input type="checkbox"/> R1411	LS35M52D11 1SBV013752R1411	LS35M55D11 1SBV013755R1411	
	Operation diagram				
Overlapping Slow action contacts	Type Order code	LS35M5 <input type="checkbox"/> C11 1SBV01375 <input type="checkbox"/> R1511	LS35M52C11 1SBV013752R1511	LS35M55C11 1SBV013755R1511	
	Operation diagram				
Slow action contacts	Type Order code	LS35M5 <input type="checkbox"/> L02 1SBV01375 <input type="checkbox"/> R1302	LS35M52L02 1SBV013752R1302	LS35M55L02 1SBV013755R1302	
	Operation diagram				
Slow action contacts	Type Order code	LS35M5 <input type="checkbox"/> L20 1SBV01375 <input type="checkbox"/> R1320	LS35M52L20 1SBV013752R1320	LS35M55L20 1SBV013755R1320	
	Operation diagram				
Snap action contacts	Type Order code	LS35M5 <input type="checkbox"/> B02 1SBV01375 <input type="checkbox"/> R1202	LS35M52B02 1SBV013752R1202	LS35M55B02 1SBV013755R1202	
	Operation				

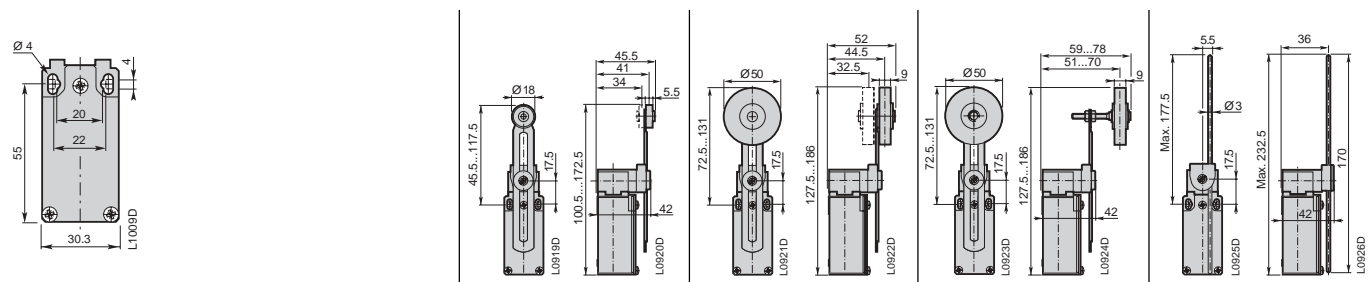

LS72M... Limit Switches

Metal Casing IP66 - 60 mm Width
3 Cable Inlets M16 x 1.5 for ISO 16 Cable Gland

Movement to be detected:

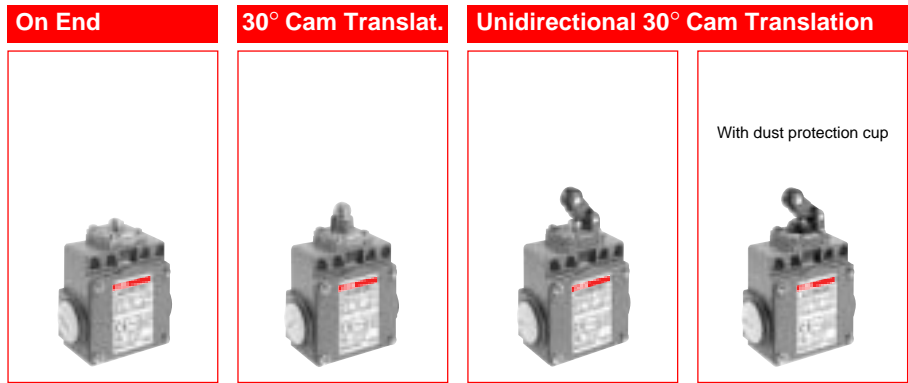



Actuator

	Plain plunger	Roller plunger	Plastic roller lever on plunger	Plastic roller lever on steel plunger
Conformity / \rightarrow (N.C. contact with positive opening operation)	-	-	-	-
Maximum actuation speed	0.5 m/s	0.3 m/s	1 m/s	1 m/s
Min. force / torque: - actuation	15 N	12 N	7 N	7 N
- positive opening operation	45 N	41 N	24 N	24 N

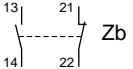
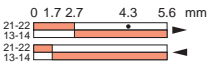
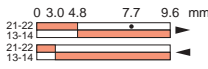
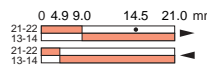
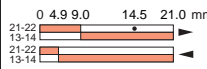
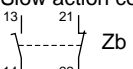
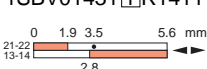
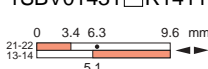
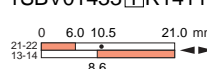
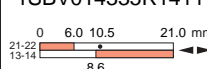
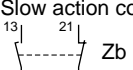
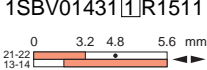
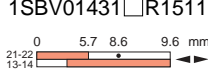
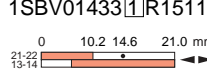
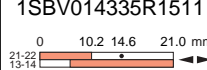
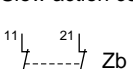
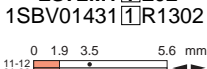
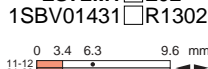
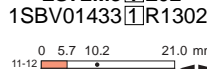
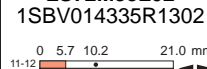
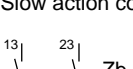
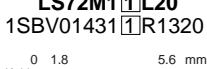
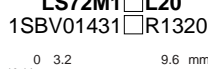
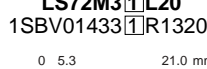
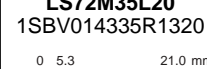
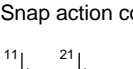
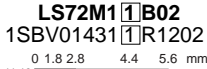
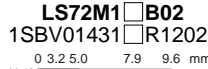
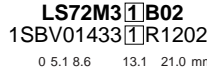
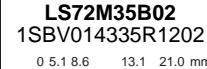
Additional Technical Data

Type and Order code to be completed with code <input type="checkbox"/>		Metal plunger <input type="checkbox"/> Plastic plunger <input checked="" type="checkbox"/>	Metal roller <input type="checkbox"/> Plastic roller <input checked="" type="checkbox"/>	Metal plunger <input type="checkbox"/> Plastic plunger <input checked="" type="checkbox"/>	- -
Snap action contacts	Type Order code	LS72M1 <input type="checkbox"/> B11 1SBV01431 <input type="checkbox"/> R1211	LS72M1 <input type="checkbox"/> B11 1SBV01431 <input type="checkbox"/> R1211	LS72M3 <input type="checkbox"/> B11 1SBV01433 <input type="checkbox"/> R1211	LS72M35B11 1SBV014335R1211
	Operation diagram				
Non-overlapping Slow action contacts	Type Order code	LS72M1 <input type="checkbox"/> D11 1SBV01431 <input type="checkbox"/> R1411	LS72M1 <input type="checkbox"/> D11 1SBV01431 <input type="checkbox"/> R1411	LS72M3 <input type="checkbox"/> D11 1SBV01433 <input type="checkbox"/> R1411	LS72M35D11 1SBV014335R1411
	Operation diagram				
Overlapping Slow action contacts	Type Order code	LS72M1 <input type="checkbox"/> C11 1SBV01431 <input type="checkbox"/> R1511	LS72M1 <input type="checkbox"/> C11 1SBV01431 <input type="checkbox"/> R1511	LS72M3 <input type="checkbox"/> C11 1SBV01433 <input type="checkbox"/> R1511	LS72M35C11 1SBV014335R1511
	Operation diagram				
Slow action contacts	Type Order code	LS72M1 <input type="checkbox"/> L02 1SBV01431 <input type="checkbox"/> R1302	LS72M1 <input type="checkbox"/> L02 1SBV01431 <input type="checkbox"/> R1302	LS72M3 <input type="checkbox"/> L02 1SBV01433 <input type="checkbox"/> R1302	LS72M35L02 1SBV014335R1302
	Operation diagram				
Slow action contacts	Type Order code	LS72M1 <input type="checkbox"/> L20 1SBV01431 <input type="checkbox"/> R1320	LS72M1 <input type="checkbox"/> L20 1SBV01431 <input type="checkbox"/> R1320	LS72M3 <input type="checkbox"/> L20 1SBV01433 <input type="checkbox"/> R1320	LS72M35L20 1SBV014335R1320
	Operation diagram				
Snap action contacts	Type Order code	LS72M1 <input type="checkbox"/> B02 1SBV01431 <input type="checkbox"/> R1202	LS72M1 <input type="checkbox"/> B02 1SBV01431 <input type="checkbox"/> R1202	LS72M3 <input type="checkbox"/> B02 1SBV01433 <input type="checkbox"/> R1202	LS72M35B02 1SBV014335R1202
	Operation diagram				
Weight (packing per unit)	kg	0.270	0.280	0.265	0.265

Special heads, accessories and special contact arrangement or particular function: please consult us.

 Closed contact /  Open contact

Dimensions (in mm)

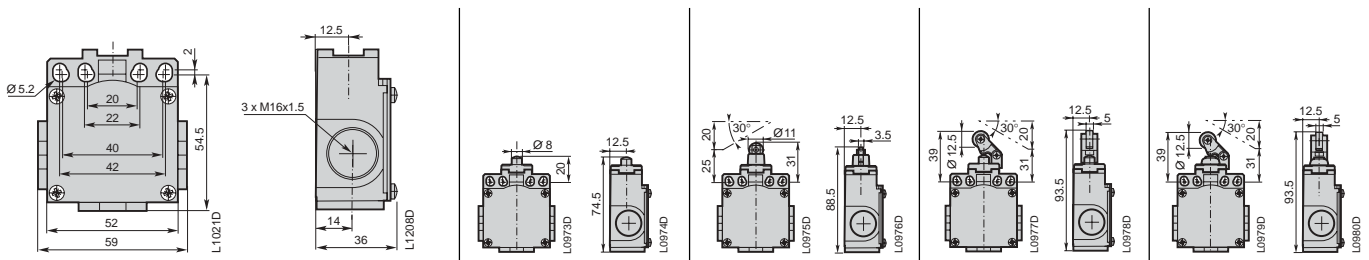

>> Description, Travel and Technical Data pages 4..11

>> Accessories page 48

>> Utilization Precautions page 51

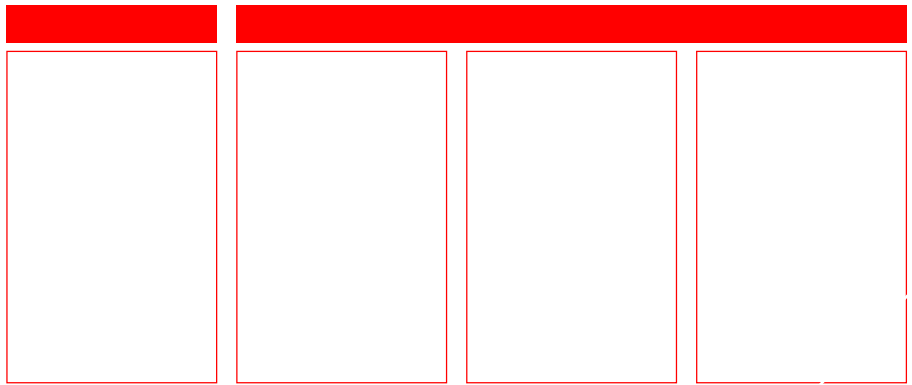



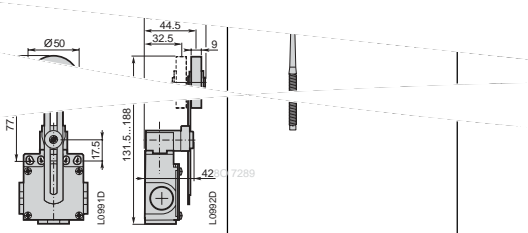
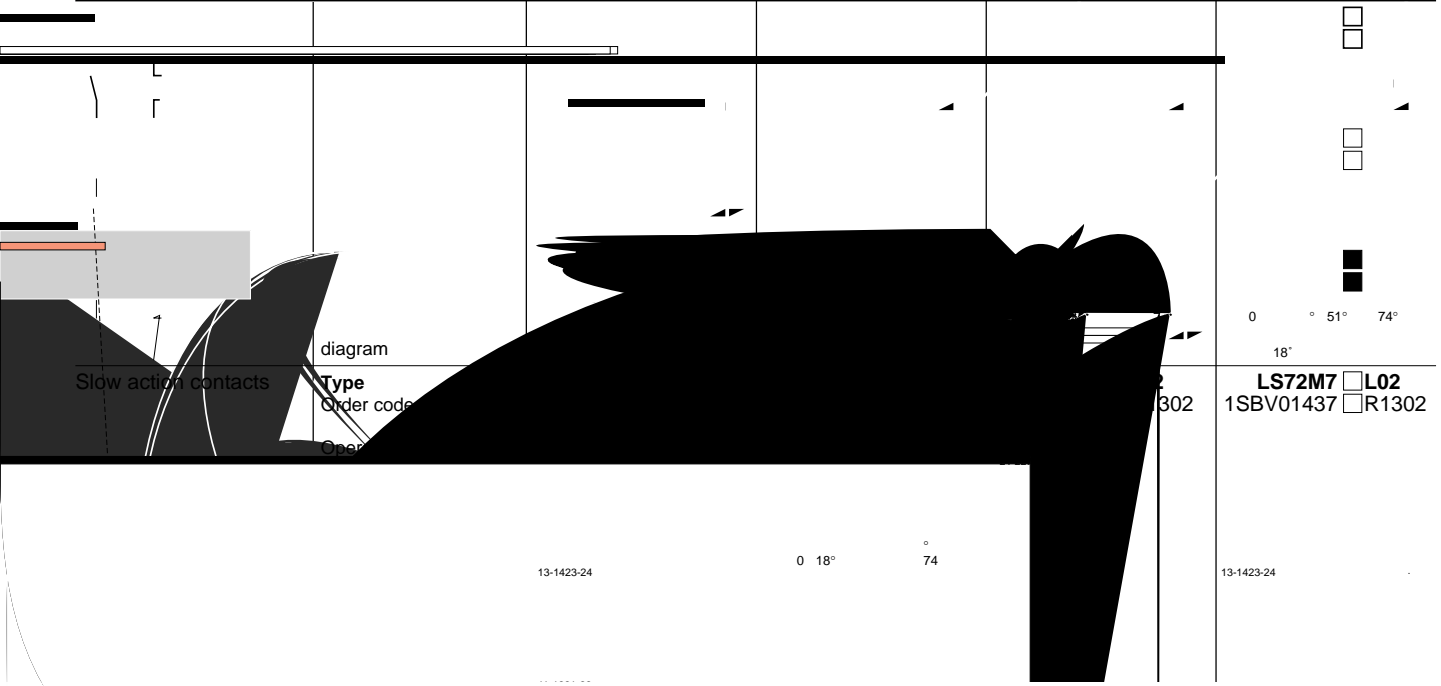
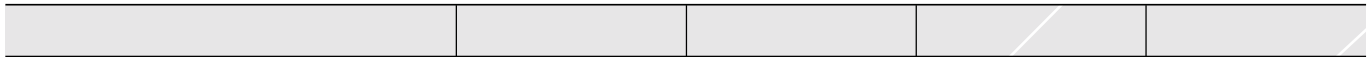

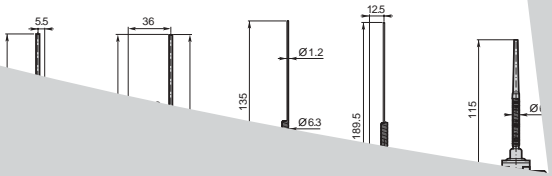
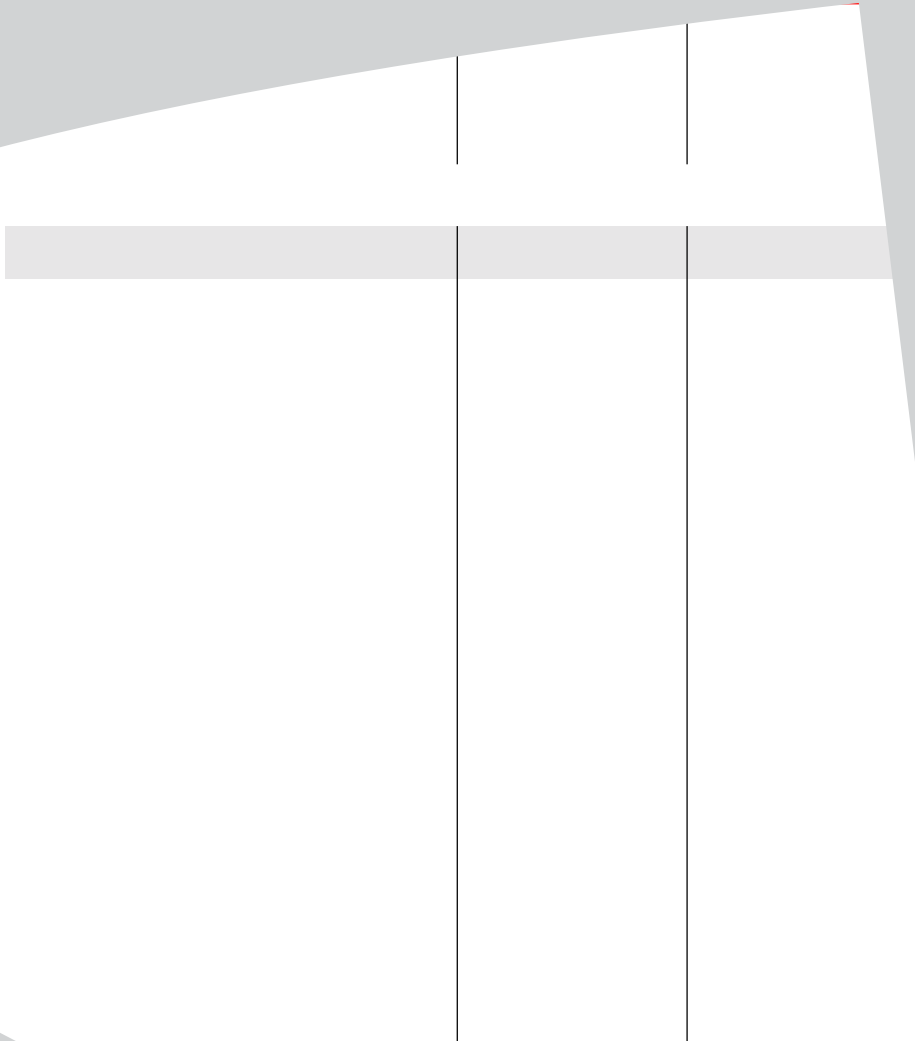

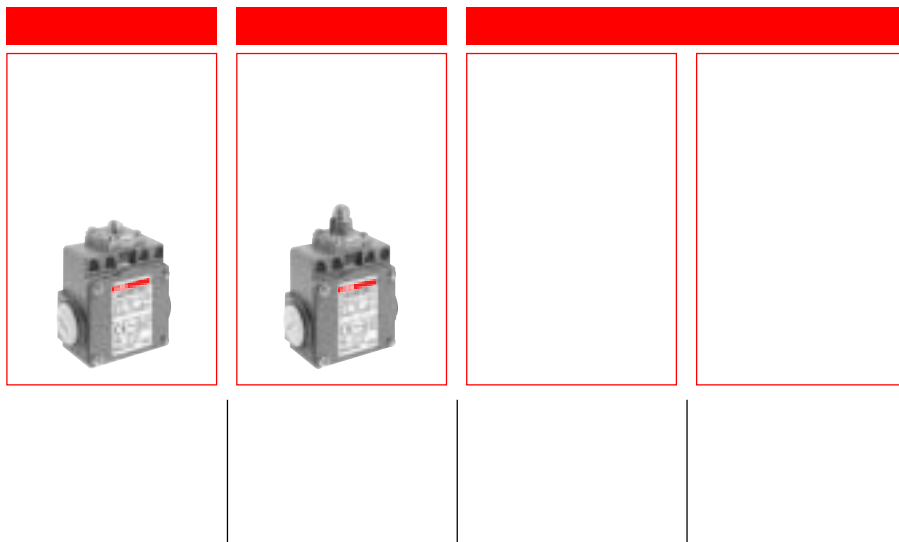





















--	--	--	--	--









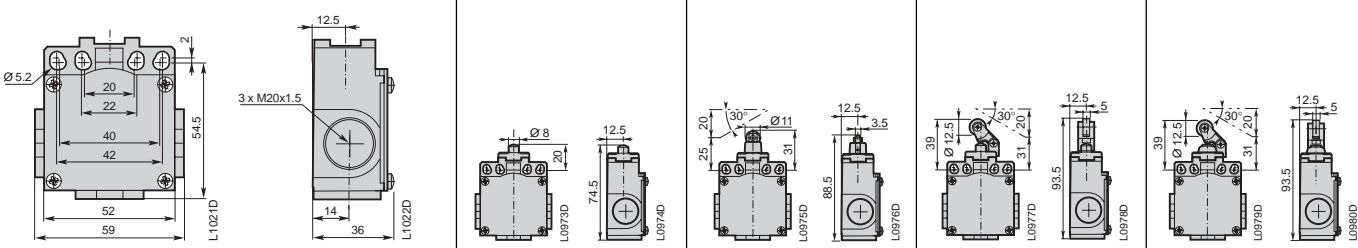

□



LS73M... Limit Switches

Metal Casing IP66 - 60 mm Width
3 Cable Inlets M20 x 1.5 for ISO 20 Cable Gland

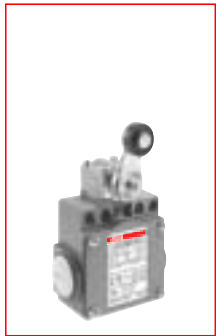
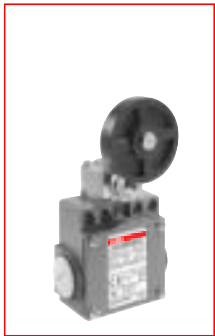
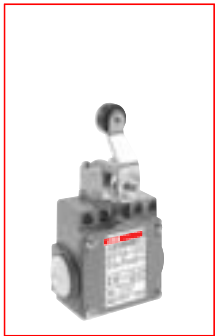
Unidirectional... 30° Cam Translation Movement

					
Adjustable plastic roller lever on plunger	ø18 roller lever	ø50 rubber roller lever	ø18 roller with bent lever	Adjustable ø18 plastic roller lever	Adjustable ø18 steel roller lever
1 m/s 7 N 24 N	1.5 m/s 0.1 N.m 0.32 N.m	1.5 m/s 0.1 N.m 0.32 N.m	1.5 m/s 0.1 N.m 0.32 N.m	1.5 m/s 0.1 N.m 0.32 N.m	1.5 m/s 0.1 N.m 0.32 N.m

Metal plunger 8 Plastic plunger *	Metal roller 3 Plastic roller 1	-	Metal roller 6 Plastic roller 5	-	-
LS73M38B11 1SBV015238R1211 0 8.8 15.0 23.2 32.0 mm	LS73M4B11 1SBV01524R1211 0 17° 31° 47° 74°	LS73M42B11 1SBV015242R1211 0 17° 31° 47° 74°	LS73M4B11 1SBV01524R1211 0 17° 31° 47° 74°	LS73M51B11 1SBV015251R1211 0 17° 31° 47° 74°	LS73M53B11 1SBV015253R1211 0 17° 31° 47° 74°
LS73M38D11 1SBV015238R1411 0 10.6 18.5 32.0 mm 15.1	LS73M4D11 1SBV01524R1411 0 21° 37° 74° 30°	LS73M42D11 1SBV015242R1411 0 21° 37° 74° 30°	LS73M4D11 1SBV01524R1411 0 21° 37° 74° 30°	LS73M51D11 1SBV015251R1411 0 21° 37° 74° 30°	LS73M53D11 1SBV015253R1411 0 21° 37° 74° 30°
LS73M38C11 1SBV015238R1511 0 16.8 25.1 32.0 mm 9.4	LS73M4C11 1SBV01524R1511 0 35° 51° 74° 18°	LS73M42C11 1SBV015242R1511 0 35° 51° 74° 18°	LS73M4C11 1SBV01524R1511 0 35° 51° 74° 18°	LS73M51C11 1SBV015251R1511 0 35° 51° 74° 18°	LS73M53C11 1SBV015253R1511 0 35° 51° 74° 18°
LS73M38L02 1SBV015238R1302 0 9.6 17.8 32.0 mm 11-12 21-22	LS73M4L02 1SBV01524R1302 0 19° 37° 74° 11-12 21-22	LS73M42L02 1SBV015242R1302 0 19° 37° 74° 11-12 21-22	LS73M4L02 1SBV01524R1302 0 19° 37° 74° 11-12 21-22	LS73M51L02 1SBV015251R1302 0 19° 37° 74° 11-12 21-22	LS73M53L02 1SBV015253R1302 0 19° 37° 74° 11-12 21-22
LS73M38L20 1SBV015238R1320 0 9.2 32.0 mm 13-14 23-24	LS73M4L20 1SBV01524R1320 0 18° 74° 13-14 23-24	LS73M42L20 1SBV015242R1320 0 18° 74° 13-14 23-24	LS73M4L20 1SBV01524R1320 0 18° 74° 13-14 23-24	LS73M51L20 1SBV015251R1320 0 18° 74° 13-14 23-24	LS73M53L20 1SBV015253R1320 0 18° 74° 13-14 23-24
LS73M38B02 1SBV015238R1202 0 8.8 14.6 22.8 32.0 mm 11-12 21-22	LS73M4B02 1SBV01524R1202 0 17° 30° 46° 74° 11-12 21-22	LS73M42B02 1SBV015242R1202 0 17° 30° 46° 74° 11-12 21-22	LS73M4B02 1SBV01524R1202 0 17° 30° 46° 74° 11-12 21-22	LS73M51B02 1SBV015251R1202 0 17° 30° 46° 74° 11-12 21-22	LS73M53B02 1SBV015253R1202 0 17° 30° 46° 74° 11-12 21-22
0.270	0.325	0.345	0.340	0.340	0.345

* Special heads, accessories and special contact arrangement or particular function: please consult us.

■ Closed contact / □ Open contact

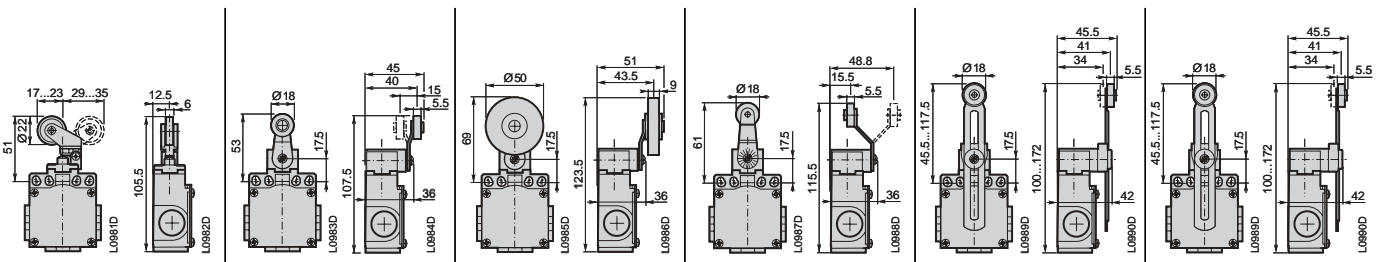



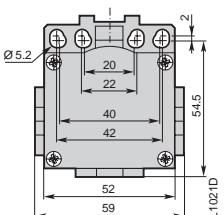
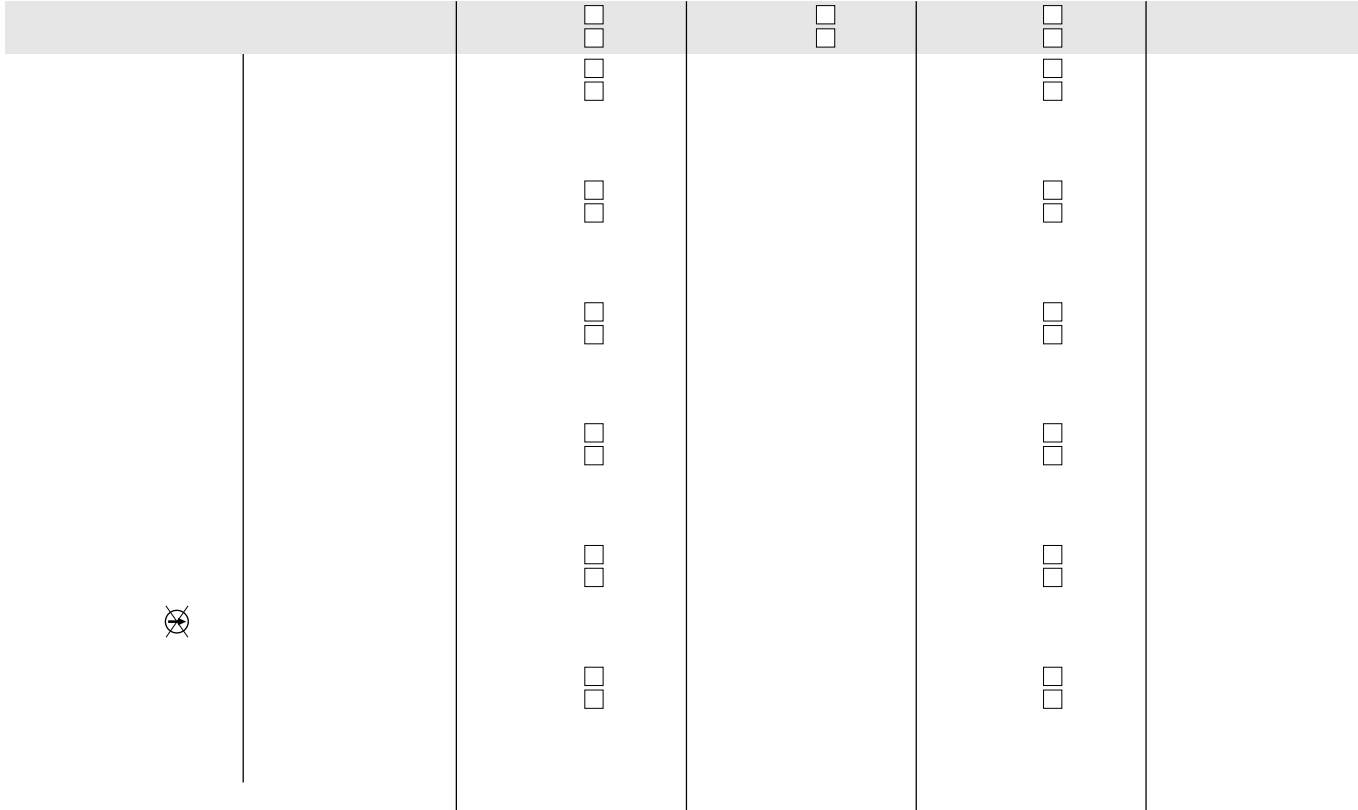
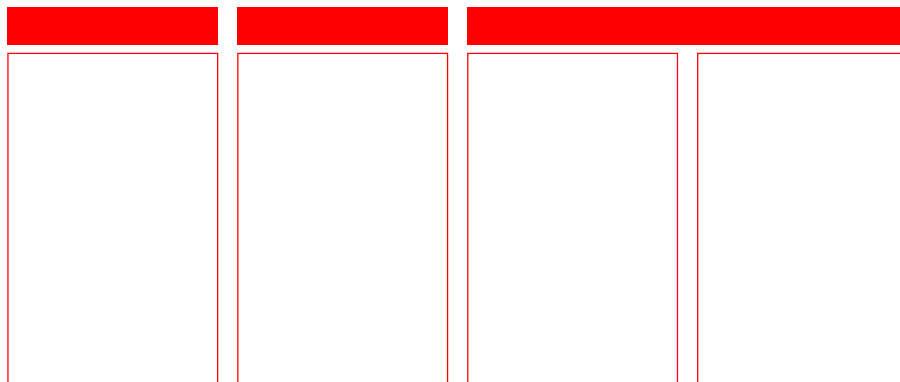

>> Description, Travel and Technical Data pages 4...11 >> Accessories page 48 >> Utilization Precautions page 51



LS75M... Limit Switches

Metal Casing IP66 - 60 mm Width
3 Cable Inlets for 1/2" NPT Cable Gland

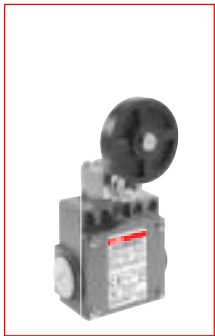
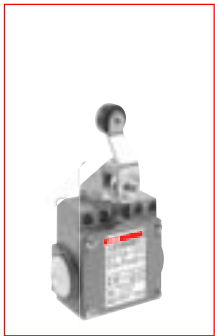
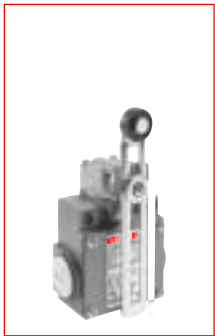
Unidirectional... 30° Cam Translation Movement

					
Adjustable plastic roller lever on plunger	ø18 roller lever	ø50 rubber roller lever	ø18 roller with bent lever	Adjustable ø18 plastic roller lever	Adjustable ø18 steel roller lever
1 m/s 7 N 24 N	1.5 m/s 0.1 N.m 0.32 N.m	1.5 m/s 0.1 N.m 0.32 N.m	1.5 m/s 0.1 N.m 0.32 N.m	1.5 m/s 0.1 N.m 0.32 N.m	1.5 m/s 0.1 N.m 0.32 N.m

Metal plunger 8 Plastic plunger *	Metal roller 3 Plastic roller 1	-	Metal roller 6 Plastic roller 5	-	-
LS75M38B11 1SBV015138R1211 0 8.8 15.0 23.2 32.0 mm	LS75M4B11 1SBV01514R1211 0 17° 31° 47° 74°	LS75M42B11 1SBV015142R1211 0 17° 31° 47° 74°	LS75M4B11 1SBV01514R1211 0 17° 31° 47° 74°	LS75M51B11 1SBV015151R1211 0 17° 31° 47° 74°	LS75M53B11 1SBV015153R1211 0 17° 31° 47° 74°
LS75M38D11 1SBV015138R1411 0 10.6 18.5 32.0 mm	LS75M4D11 1SBV01514R1411 0 21° 37° 74°	LS75M42D11 1SBV015142R1411 0 21° 37° 74°	LS75M4D11 1SBV01514R1411 0 21° 37° 74°	LS75M51D11 1SBV015151R1411 0 21° 37° 74°	LS75M53D11 1SBV015153R1411 0 21° 37° 74°
LS75M38C11 1SBV015138R1511 0 16.8 25.1 32.0 mm	LS75M4C11 1SBV01514R1511 0 35° 51° 74°	LS75M42C11 1SBV015142R1511 0 35° 51° 74°	LS75M4C11 1SBV01514R1511 0 35° 51° 74°	LS75M51C11 1SBV015151R1511 0 35° 51° 74°	LS75M53C11 1SBV015153R1511 0 35° 51° 74°
LS75M38L02 1SBV015138R1302 0 9.6 17.8 32.0 mm	LS75M4L02 1SBV01514R1302 0 19° 37° 74°	LS75M42L02 1SBV015142R1302 0 19° 37° 74°	LS75M4L02 1SBV01514R1302 0 19° 37° 74°	LS75M51L02 1SBV015151R1302 0 19° 37° 74°	LS75M53L02 1SBV015153R1302 0 19° 37° 74°
LS75M38L20 1SBV015138R1320 0 9.2 32.0 mm	LS75M4L20 1SBV01514R1320 0 18° 74°	LS75M42L20 1SBV015142R1320 0 18° 74°	LS75M4L20 1SBV01514R1320 0 18° 74°	LS75M51L20 1SBV015151R1320 0 18° 74°	LS75M53L20 1SBV015153R1320 0 18° 74°
LS75M38B02 1SBV015138R1202 0 8.8 14.6 22.8 32.0 mm	LS75M4B02 1SBV01514R1202 0 17° 30° 46° 74°	LS75M42B02 1SBV015142R1202 0 17° 30° 46° 74°	LS75M4B02 1SBV01514R1202 0 17° 30° 46° 74°	LS75M51B02 1SBV015151R1202 0 17° 30° 46° 74°	LS75M53B02 1SBV015153R1202 0 17° 30° 46° 74°
0.270	0.325	0.345	0.340	0.340	0.345

* Special heads, accessories and special contact arrangement or particular function: please consult us.

■ Closed contact / □ Open contact

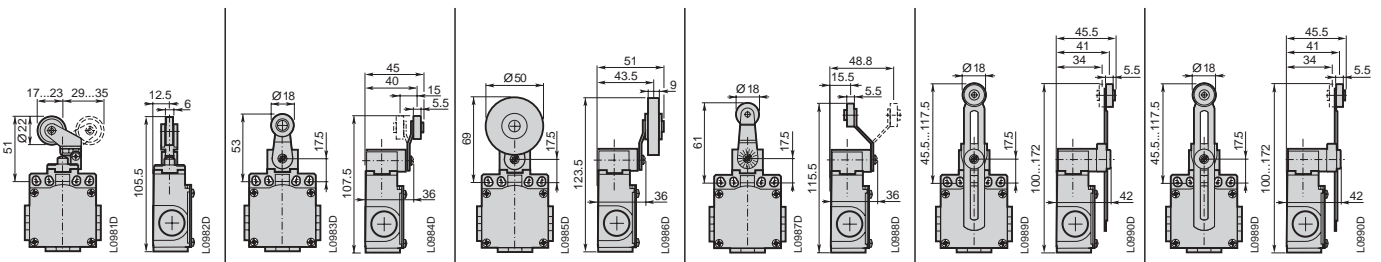

LS75M... Limit Switches

Metal Casing IP66 - 60 mm Width
3 Cable Inlets for 1/2" NPT Cable Gland

Movement to be detected:

30° Cam Translat.

Fully Directional Translation Movement

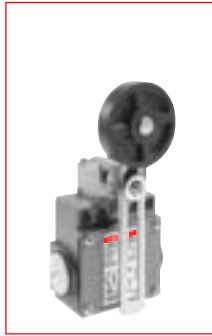

Actuator

	Adjustable ø50 rubber roller lever	Flexible lever with insulated end	Coil spring lever	Adjustable ø3 rod lever
Conformity / \odot (N.C. contact with positive opening operation)	-	-	-	-
Maximum actuation speed	1.5 m/s	1.5 m/s	1.5 m/s	1.5 m/s
Min. force / torque: - actuation	0.1 N.m	0.1 N.m	0.1 N.m	0.1 N.m
- positive opening operation	0.32 N.m	-	-	0.32 N.m

Additional Technical Data

Type and Order code to be completed with code <input type="checkbox"/>	-	-	-	Metal rod <input type="checkbox"/> 1 Fibre-glass rod <input type="checkbox"/> 2	
Snap action contacts	Type Order code	LS75M52B11 1SBV015152R1211	LS75M61B11 1SBV015161R1211	LS75M62B11 1SBV015162R1211	LS75M7 <input type="checkbox"/> B11 1SBV01517 <input type="checkbox"/> R1211
	Operation diagram				
Non-overlapping Slow action contacts	Type Order code	LS75M52D11 1SBV015152R1411	LS75M61D11 1SBV015161R1411	LS75M62D11 1SBV015162R1411	LS75M7 <input type="checkbox"/> D11 1SBV01517 <input type="checkbox"/> R1411
	Operation diagram				
Overlapping Slow action contacts	Type Order code	LS75M52C11 1SBV015152R1511	LS75M61C11 1SBV015161R1511	LS75M62C11 1SBV015162R1511	LS75M7 <input type="checkbox"/> C11 1SBV01517 <input type="checkbox"/> R1511
	Operation diagram				
Slow action contacts	Type Order code	LS75M52L02 1SBV015152R1302	LS75M61L02 1SBV015161R1302	LS75M62L02 1SBV015162R1302	LS75M7 <input type="checkbox"/> L02 1SBV01517 <input type="checkbox"/> R1302
	Operation diagram				
Slow action contacts	Type Order code	LS75M52L20 1SBV015152R1320	LS75M61L20 1SBV015161R1320	LS75M62L20 1SBV015162R1320	LS75M7 <input type="checkbox"/> L20 1SBV01517 <input type="checkbox"/> R1320
	Operation diagram				
Snap action contacts	Type Order code	LS75M52B02 1SBV015152R1202	LS75M61B02 1SBV015161R1202	LS75M62B02 1SBV015162R1202	LS75M7 <input type="checkbox"/> B02 1SBV01517 <input type="checkbox"/> R1202
	Operation diagram				
Weight (packing per unit)	kg	0.355	0.375	0.380	0.380

Special heads, accessories and special contact arrangement or particular function: please consult us.

Closed contact / Open contact

Dimensions (in mm)

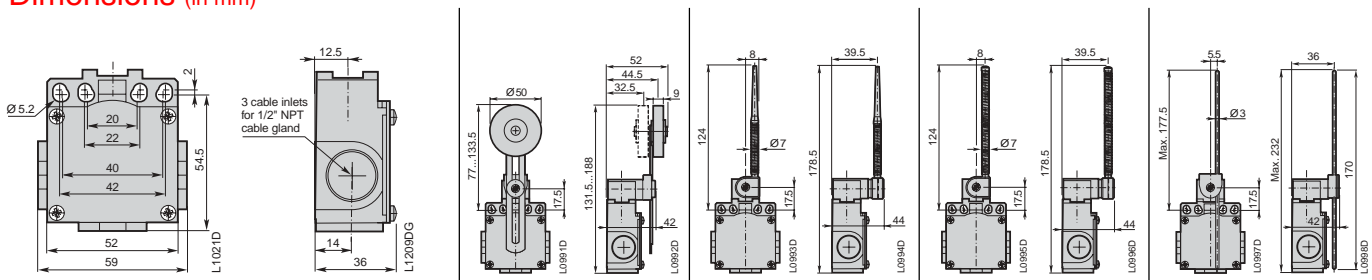

>> Description, Travel and Technical Data pages 4..11

>> Accessories page 48

>> Utilization Precautions page 51

LS75M... Limit Switches

Metal Casing IP66 - 60 mm Width
3 Cable Inlets for 1/2" NPT Cable Gland

Fully Directional Translation Movement

Multidirectional

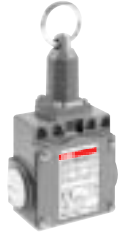
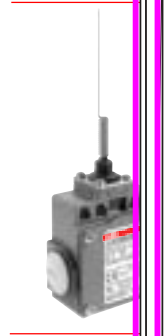
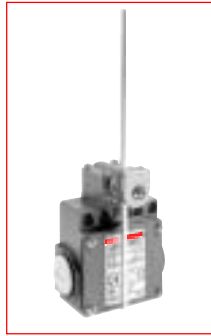
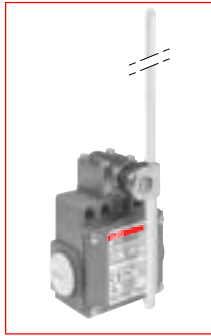
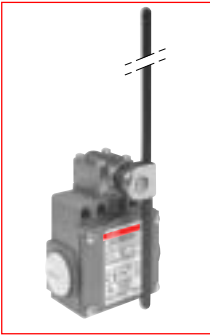

Adjustable ø6 polyamide rod lever

Adjustable ø6 fibre-glass rod lever

Adjustable ø3 square steel rod lever

Spring rod

Flexible rod with insulated end

Pull action with ring

1.5 m/s
0.1 N.m
0.32 N.m

1.5 m/s
0.1 N.m
0.32 N.m

1.5 m/s
0.1 N.m
0.32 N.m

1 m/s
0.12 N.m

1 m/s
0.12 N.m

0.5 m/s
30 N

Fully Directional Translation Movement		Multidirectional			
LS75M73B11 1SBV015173R1211	LS75M74B11 1SBV015174R1211	LS75M78B11 1SBV015178R1211	LS75M91B11 1SBV015191R1211	LS75M92B11 1SBV015192R1211	LS75M98B11-A 1SBV015198R1211
LS75M73D11 1SBV015173R1411	LS75M74D11 1SBV015174R1411	LS75M78D11 1SBV015178R1411	LS75M91D11 1SBV015191R1411	LS75M92D11 1SBV015192R1411	LS75M98D11-A 1SBV015198R1411
LS75M73C11 1SBV015173R1511	LS75M74C11 1SBV015174R1511	LS75M78C11 1SBV015178R1511	LS75M91C11 1SBV015191R1511	LS75M92C11 1SBV015192R1511	
LS75M73L02 1SBV015173R1302	LS75M74L02 1SBV015174R1302	LS75M78L02 1SBV015178R1302	LS75M91L02 1SBV015191R1302	LS75M92L02 1SBV015192R1302	LS75M98L02-A 1SBV015198R1302
LS75M73L20 1SBV015173R1320	LS75M74L20 1SBV015174R1320	LS75M78L20 1SBV015178R1320	LS75M91L20 1SBV015191R1320	LS75M92L20 1SBV015192R1320	LS75M98L20-A 1SBV015198R1320
LS75M73B02 1SBV015173R1202	LS75M74B02 1SBV015174R1202	LS75M78B02 1SBV015178R1202	LS75M91B02 1SBV015191R1202	LS75M92B02 1SBV015192R1202	
0.390	0.390	0.375	0.315	0.320	0.350

☒ Special heads, accessories and special contact arrangement or particular function: please consult us.

■ Closed contact / □ Open contact

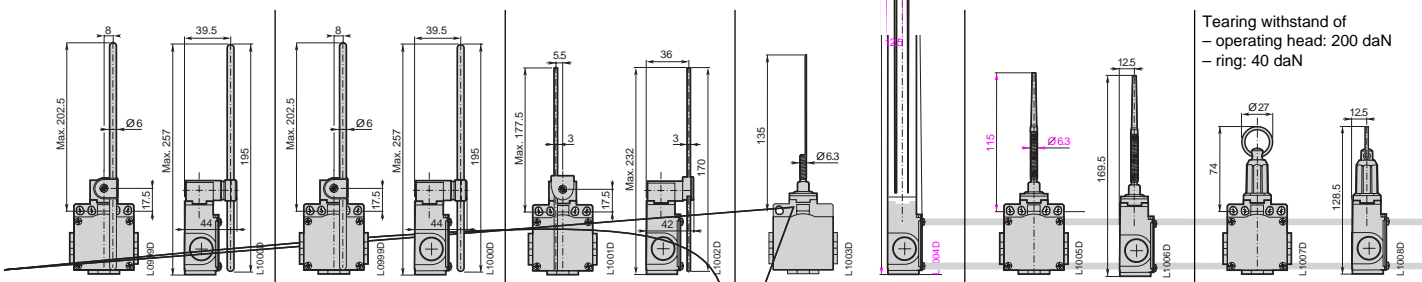





>> Description, Travel and Technical Data pages 4...11 >> Accessories page 48 >> Utilization Precautions page 51









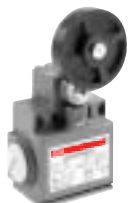





LS72P... Limit Switches

Double Insulation - Plastic Casing IP65 - 60 mm Width
2 Cable Inlets M16 x 1.5 for ISO 16 Cable Gland



Unidirectional 30° Cam Translation Movement

30° Cam Translation Movement

					
Plastic roller lever on steel plunger	Plastic roller lever on steel plunger With dust protection cup	Adjustable plastic roller lever on plunger	ø18 plastic roller lever	ø18 steel roller lever	ø50 rubber roller lever
1 m/s 7 N 24 N	1 m/s 7 N 24 N	1 m/s 7 N 24 N	1.5 m/s 0.1 N.m 0.32 N.m	1.5 m/s 0.1 N.m 0.32 N.m	1.5 m/s 0.1 N.m 0.32 N.m

-		Metal plunger 		-		-	
-		Plastic plunger 		-		-	
LS72P31B11 1SBV011031R1211	LS72P35B11 1SBV 011035R1211	LS72P3B11 1SBV 01103  R1211	LS72P41B11 1SBV011041R1211	LS72P43B11 1SBV011043R1211	LS72P42B11 1SBV011042R1211		
0 4.9 9.0 14.5 21.0 mm	0 4.9 9.0 14.5 21.0 mm	0 8.8 15.0 23.2 32.0 mm	0 17° 31° 47° 74°	0 17° 31° 47° 74°	0 17° 31° 47° 74°		
21-22 13-14	21-22 13-14	21-22 13-14	21-22 13-14	21-22 13-14	21-22 13-14		
LS72P31D11 1SBV011031R1411	LS72P35D11 1SBV011035R1411	LS72P3D11 1SBV01103  R1411	LS72P41D11 1SBV011041R1411	LS72P43D11 1SBV011043R1411	LS72P42D11 1SBV011042R1411		
0 6.0 10.5 21.0 mm	0 6.0 10.5 21.0 mm	0 10.6 18.5 32.0 mm	0 21° 37° 74°	0 21° 37° 74°	0 21° 37° 74°		
21-22 13-14	21-22 13-14	21-22 13-14	21-22 13-14	21-22 13-14	21-22 13-14		
LS72P31C11 1SBV011031R1511	LS72P35C11 1SBV011035R1511	LS72P3C11 1SBV01103  R1511	LS72P41C11 1SBV011041R1511	LS72P43C11 1SBV011043R1511	LS72P42C11 1SBV011042R1511		
0 10.2 14.6 21.0 mm	0 10.2 14.6 21.0 mm	0 16.8 25.1 32.0 mm	0 35° 51° 74°	0 35° 51° 74°	0 35° 51° 74°		
21-22 13-14	21-22 13-14	21-22 13-14	21-22 13-14	21-22 13-14	21-22 13-14		
LS72P31L02 1SBV011031R1302	LS72P35L02 1SBV011035R1302	LS72P3L02 1SBV01103  R1302	LS72P41L02 1SBV011041R1302	LS72P43L02 1SBV011043R1302	LS72P42L02 1SBV011042R1302		
0 5.7 10.2 21.0 mm	0 5.7 10.2 21.0 mm	0 9.6 17.8 32.0 mm	0 19° 37° 74°	0 19° 37° 74°	0 19° 37° 74°		
11-12 21-22	11-12 21-22	11-12 21-22	11-12 21-22	11-12 21-22	11-12 21-22		
LS72P31L20 1SBV011031R1320	LS72P35L20 1SBV011035R1320	LS72P3L20 1SBV01103  R1320	LS72P41L20 1SBV011041R1320	LS72P43L20 1SBV011043R1320	LS72P42L20 1SBV011042R1320		
0 5.3 21.0 mm	0 5.3 21.0 mm	0 9.2 32.0 mm	0 18° 74°	0 18° 74°	0 18° 74°		
13-14 23-24	13-14 23-24	13-14 23-24	13-14 23-24	13-14 23-24	13-14 23-24		
LS72P31B02 1SBV011031R1202	LS72P35B02 1SBV 011035R1202	LS72P3B02 1SBV01103  R1202	LS72P41B02 1SBV011041R1202	LS72P43B02 1SBV011043R1202	LS72P42B02 1SBV011042R1202		
0 5.1 8.6 13.1 21.0 mm	0 5.1 8.6 13.1 21.0 mm	0 8.8 14.6 22.8 32.0 mm	0 17° 30° 46° 74°	0 17° 30° 46° 74°	0 17° 30° 46° 74°		
11-12 21-22	11-12 21-22	11-12 21-22	11-12 21-22	11-12 21-22	11-12 21-22		
0.105	0.105	0.110	0.130	0.135	0.145		

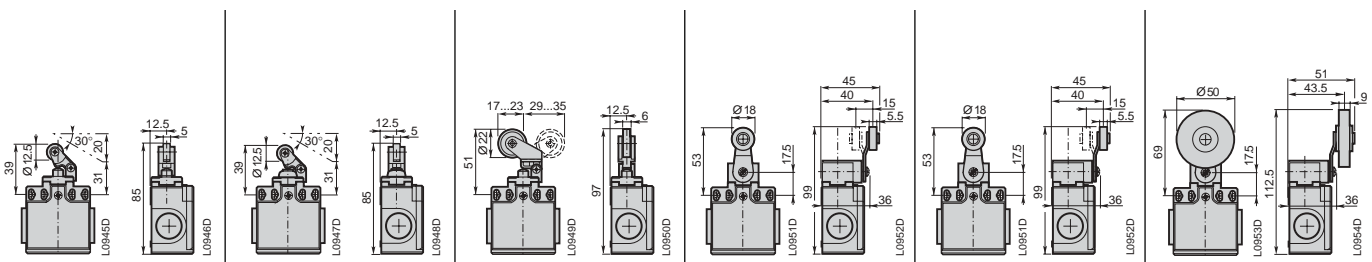

 Special heads, accessories and special contact arrangement or particular function: please consult us.

 Closed contact /  Open contact

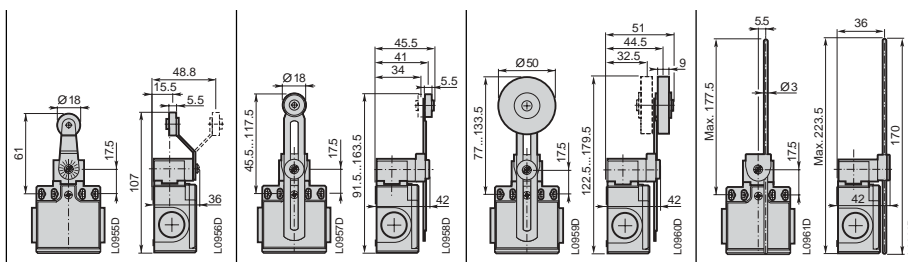
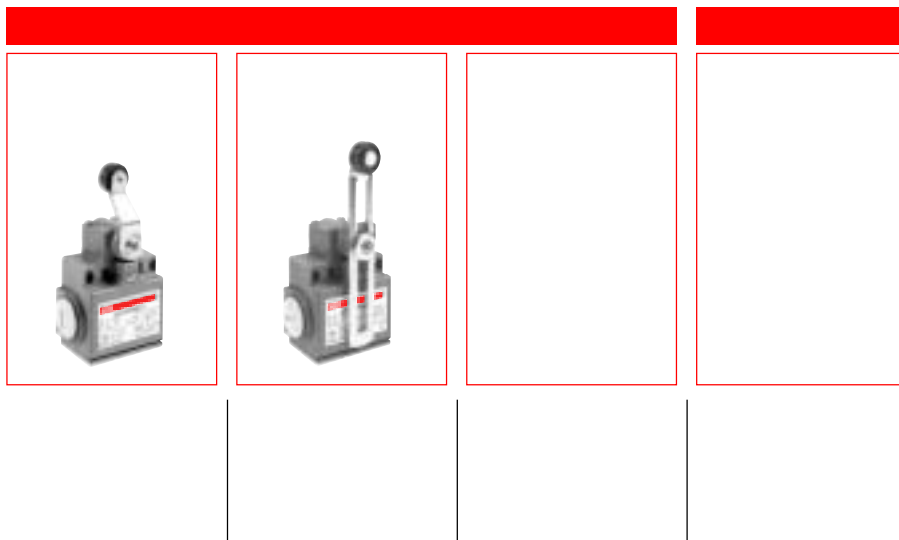

>> Description, Travel and Technical Data pages 4...11 >> Accessories page 48 >> Utilization Precautions page 51

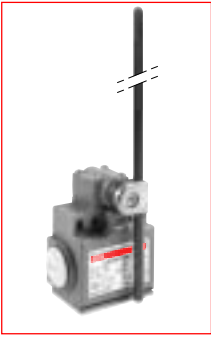
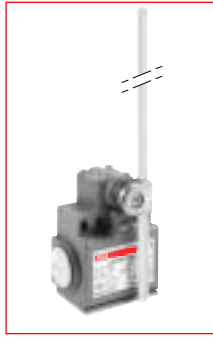
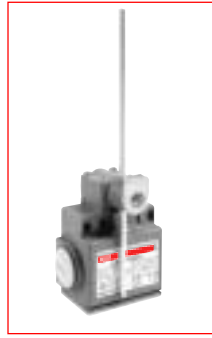
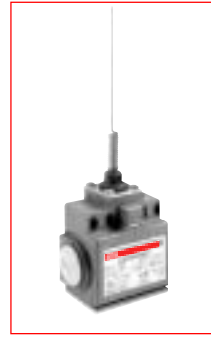

					
Adjustable ø6 polyamide rod lever	Adjustable ø6 fibre-glass rod lever	Adjustable 3 square steel rod lever	Spring rod	Flexible rod with insulated end	Pull action with ring
1.5 m/s 0.1 N.m 0.32 N.m	1.5 m/s 0.1 N.m 0.32 N.m	1.5 m/s 0.1 N.m 0.32 N.m	1 m/s 0.12 N.m -	1 m/s 0.12 N.m -	0.5 m/s 30 N -

LS72P73B11 1SBV011073R1211	LS72P74B11 1SBV011074R1211	LS72P78B11 1SBV011078R1211	LS72P91B11 1SBV011091R1211	LS72P92B11 1SBV011092R1211	LS72P98B11-A 1SBV011098R1211
0 17° 31° 47° 74°	0 17° 31° 47° 74°	0 17° 31° 47° 74°	0 12° 23° 36°	0 12° 23° 36°	0 0.9 2.0 5.6 mm
21-22 13-14	21-22 13-14	21-22 13-14	21-22 13-14	21-22 13-14	21-22 13-14
LS72P73D11 1SBV011073R1411	LS72P74D11 1SBV011074R1411	LS72P78D11 1SBV011078R1411	LS72P91D11 1SBV011091R1411	LS72P92D11 1SBV011092R1411	LS72P98D11-A 1SBV011098R1411
0 21° 37° 74°	0 21° 37° 74°	0 21° 37° 74°	0 14° 36°	0 14° 36°	0 1.0 5.6 mm
21-22 13-14	21-22 13-14	21-22 13-14	21-22 13-14	21-22 13-14	21-22 13-14
LS72P73C11 1SBV011073R1511	LS72P74C11 1SBV011074R1511	LS72P78C11 1SBV011078R1511	LS72P91C11 1SBV011091R1511	LS72P92C11 1SBV011092R1511	
0 35° 51° 74°	0 35° 51° 74°	0 35° 51° 74°	0 25° 36°	0 25° 36°	
21-22 13-14	21-22 13-14	21-22 13-14	21-22 13-14	21-22 13-14	
LS72P73L02 1SBV011073R1302	LS72P74L02 1SBV011074R1302	LS72P78L02 1SBV011078R1302	LS72P91L02 1SBV011091R1302	LS72P92L02 1SBV011092R1302	LS72P98L02-A 1SBV011098R1302
0 19° 37° 74°	0 19° 37° 74°	0 19° 37° 74°	0 14° 36°	0 14° 36°	0 2.0 5.6 mm
11-12 21-22	11-12 21-22	11-12 21-22	11-12 21-22	11-12 21-22	11-12 21-22
LS72P73L20 1SBV011073R1320	LS72P74L20 1SBV011074R1320	LS72P78L20 1SBV011078R1320	LS72P91L20 1SBV011091R1320	LS72P92L20 1SBV011092R1320	LS72P98L20-A 1SBV011098R1320
0 18° 74°	0 18° 74°	0 18° 74°	0 13° 36°	0 13° 36°	0 1.8
13-14 23-24	13-14 23-24	13-14 23-24	13-14 23-24	13-14 23-24	

□

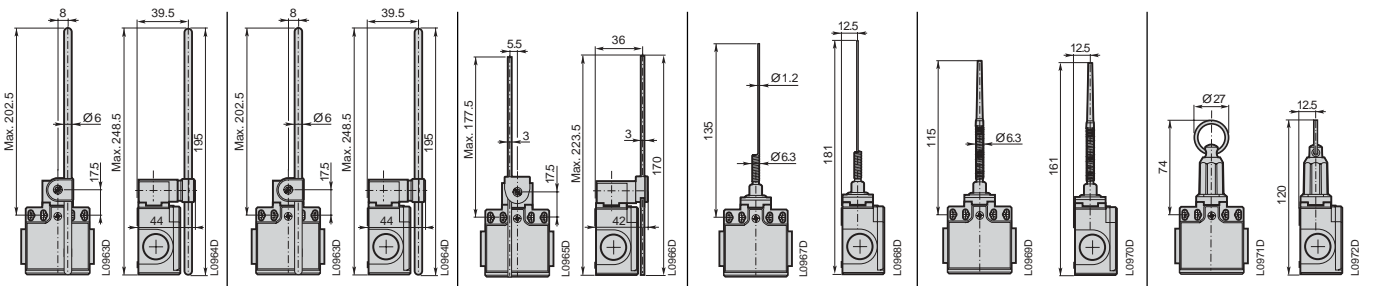

LS73P... Limit Switches

Double Insulation - Plastic Casing IP65 - 60 mm Width
2 Cable Inlets M20 x 1.5 for ISO 20 Cable Gland



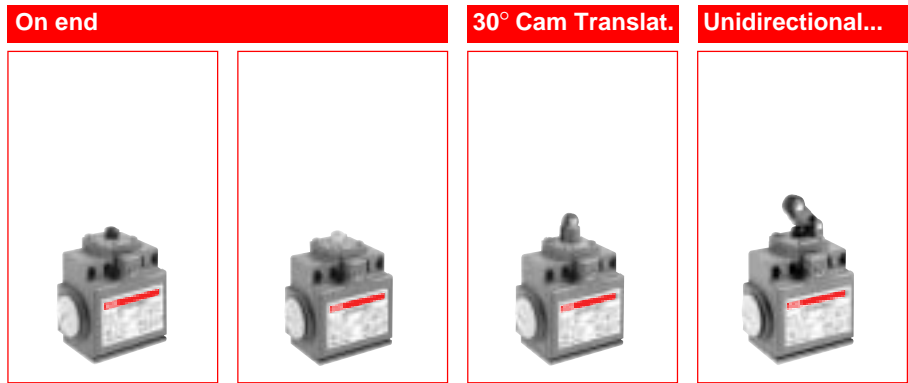







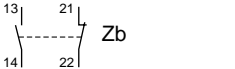

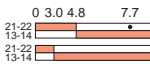
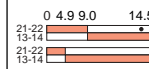
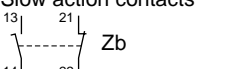

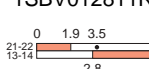
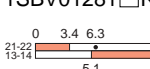
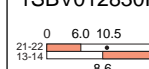
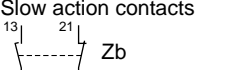

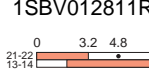
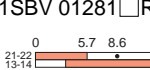
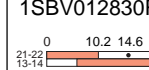
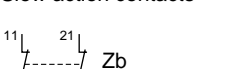
Movement to be detected:

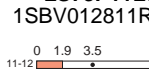

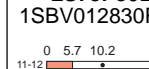
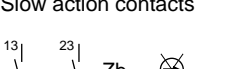

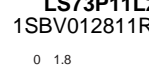
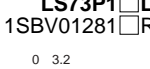
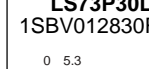
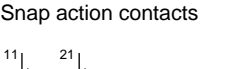
Actuator

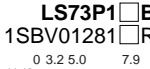
	Plastic plain plunger	Steel plain plunger	Roller plunger	Plastic roller lever on plastic plunger
Conformity / \ominus (N.C. contact with positive opening operation)	-	-	-	-
Maximum actuation speed	0.5 m/s	0.5 m/s	0.3 m/s	1 m/s
Min. force / torque: - actuation	15 N	15 N	12 N	7 N
- positive opening operation	45 N	45 N	41 N	24 N

Additional Technical Data

Type and Order code to be completed with code <input type="checkbox"/>	-	-	Metal roller <input type="checkbox"/> 2 Plastic roller <input type="checkbox"/> 3	-	
Snap action contacts	Type Order code	LS73P10B11 1SBV012810R1211	LS73P11B11 1SBV012811R1211	LS73P1□B11 1SBV01281□R1211	LS73P30B11 1SBV012830R1211
	Operation diagram				
Non-overlapping Slow action contacts	Type Order code	LS73P10D11 1SBV012810R1411	LS73P11D11 1SBV012811R1411	LS73P1□D11 1SBV01281□R1411	LS73P30D11 1SBV012830R1411
	Operation diagram				
Overlapping Slow action contacts	Type Order code	LS73P10C11 1SBV012810R1511	LS73P11C11 1SBV012811R1511	LS73P1□C11 1SBV 01281□R1511	LS73P30C11 1SBV012830R1511
	Operation diagram				
Slow action contacts	Type Order code	LS73P10L02 1SBV012810R1302	LS73P11L02 1SBV012811R1302	LS73P1□L02 1SBV01281□R1302	LS73P30L02 1SBV012830R1302
	Operation diagram				
Slow action contacts	Type Order code	LS73P10L20 1SBV012810R1320	LS73P11L20 1SBV012811R1320	LS73P1□L20 1SBV01281□R1320	LS73P30L20 1SBV012830R1320
	Operation diagram				
Snap action contacts	Type Order code	LS73P10B02 1SBV012810R1202	LS73P11B02 1SBV012811R1202	LS73P1□B02 1SBV01281□R1202	LS73P30B02 1SBV012830R1202
	Operation diagram				
Weight (packing per unit)	kg	0.095	0.100	0.105	0.100

Special heads, accessories and special contact arrangement or particular function: please consult us..

 Closed contact /  Open contact

Dimensions (in mm)

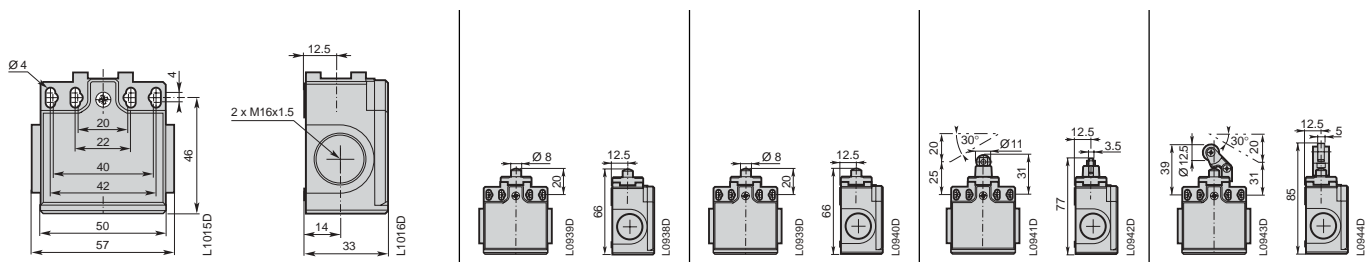

>> Description, Travel and Technical Data pages 4..11

>> Accessories page 48

>> Utilization Precautions page 51

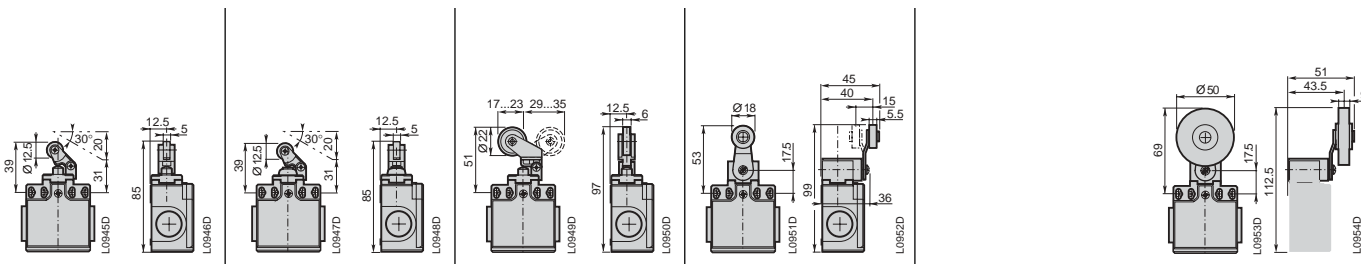
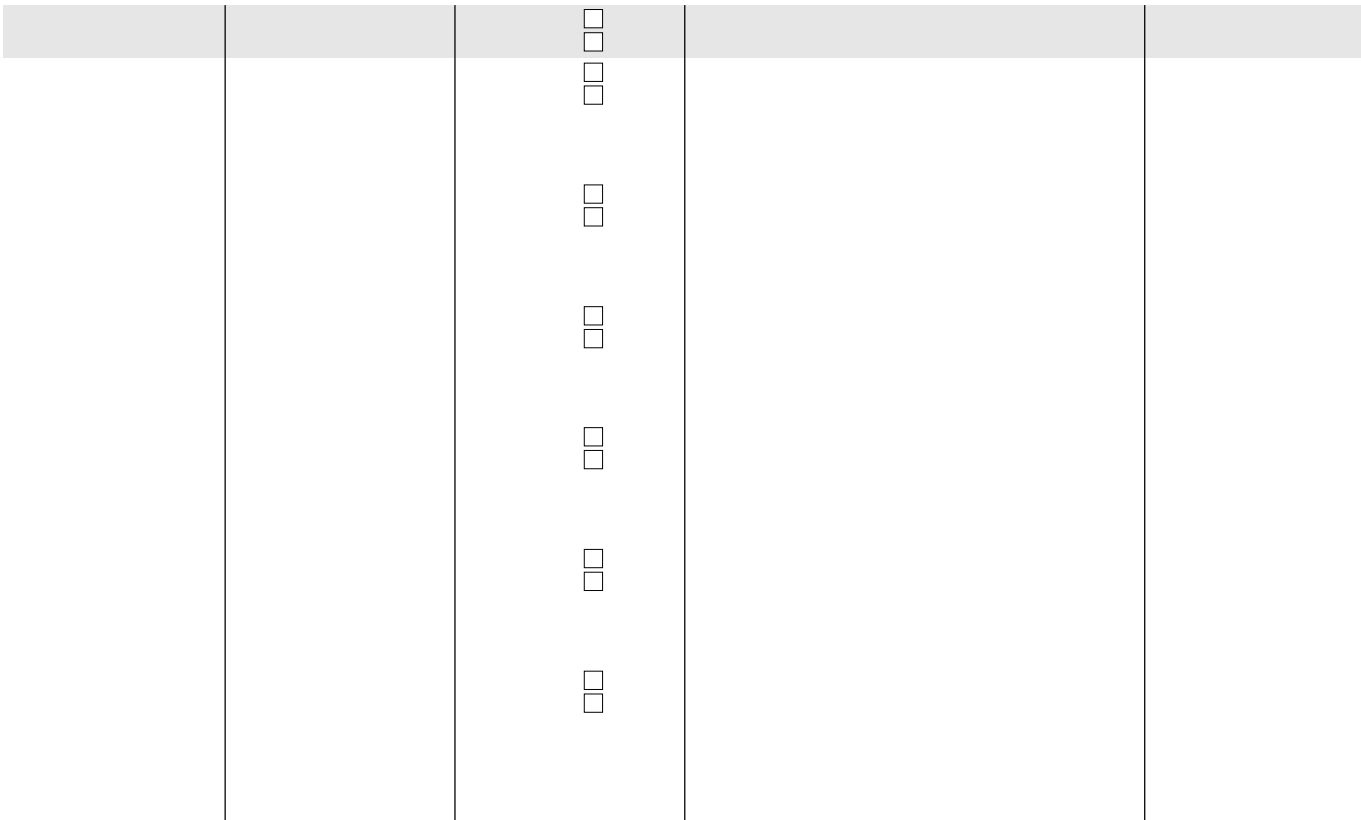
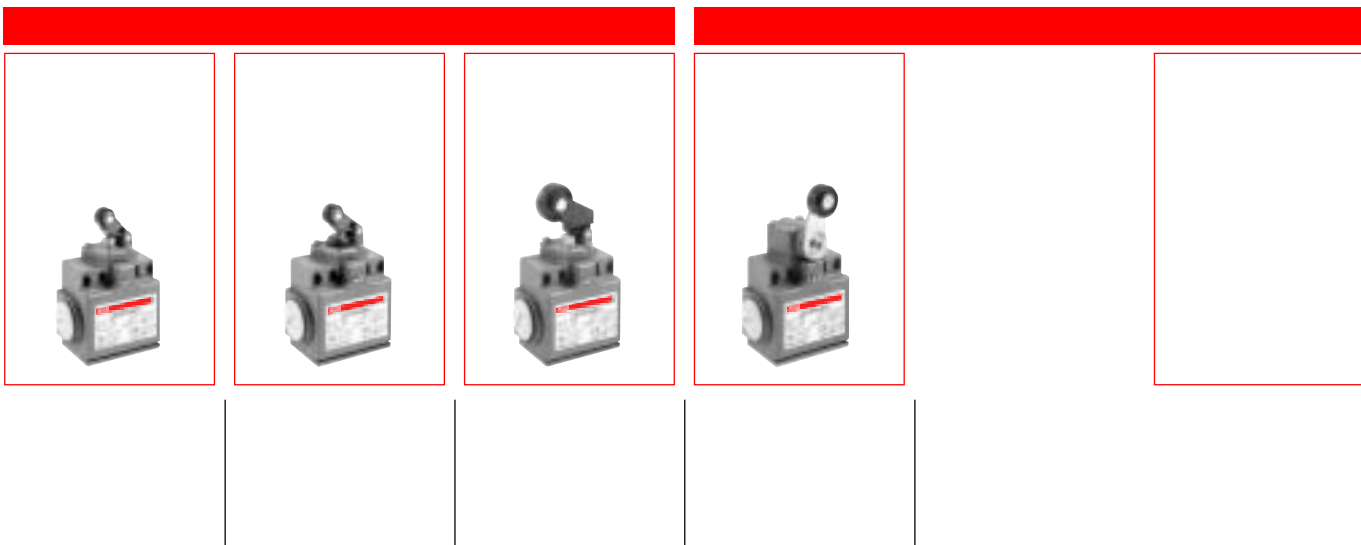

LS73P... Limit Switches

Double Insulation - Plastic Casing IP65 - 60 mm Width
2 Cable Inlets M20 x 1.5 for ISO 20 Cable Gland

Movement to be detected:

30° Cam Translation Movement

Fully Directional...

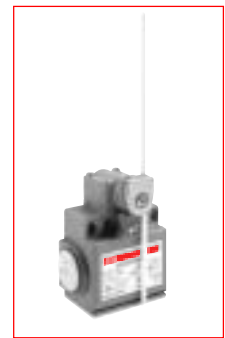
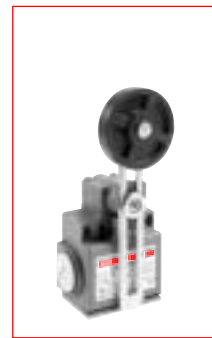
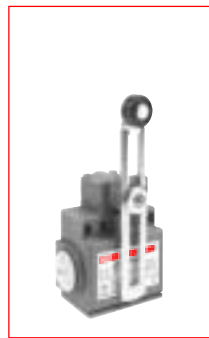
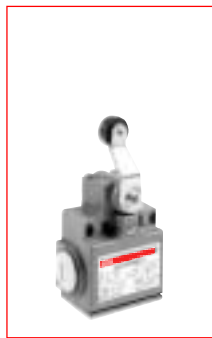

Actuator

	ø18 roller with bent lever	Adjustable ø18 roller lever	Adjustable ø50 rubber roller lever	Adjustable ø3 rod lever
Conformity / (N.C. contact with positive opening operation)	–	–	–	–
Maximum actuation speed	1.5 m/s	1.5 m/s	1.5 m/s	1.5 m/s
Min. force / torque: - actuation	0.1 N.m	0.1 N.m	0.1 N.m	0.1 N.m
- positive opening operation	0.32 N.m	0.32 N.m	0.32 N.m	0.32 N.m

Additional Technical Data

Type and Order code to be completed with code <input type="checkbox"/>		Metal roller <input type="checkbox"/> 6 Plastic roller <input type="checkbox"/> 5	Metal roller <input type="checkbox"/> 3 Plastic roller <input type="checkbox"/> 1	–	Metal rod <input type="checkbox"/> 1 Fibre-glass rod <input type="checkbox"/> 2
Snap action contacts	Type Order code	LS73P4 <input type="checkbox"/> B11 1SBV01284 <input type="checkbox"/> R1211	LS73P5 <input type="checkbox"/> B11 1SBV01285 <input type="checkbox"/> R1211	LS73P52B11 1SBV012852R1211	LS73P7 <input type="checkbox"/> B11 1SBV01287 <input type="checkbox"/> R1211
	Operation diagram				
Non-overlapping Slow action contacts	Type Order code	LS73P4 <input type="checkbox"/> D11 1SBV01284 <input type="checkbox"/> R1411	LS73P5 <input type="checkbox"/> D11 1SBV01285 <input type="checkbox"/> R1411	LS73P52D11 1SBV012852R1411	LS73P7 <input type="checkbox"/> D11 1SBV01287 <input type="checkbox"/> R1411
	Operation diagram				
Overlapping Slow action contacts	Type Order code	LS73P4 <input type="checkbox"/> C11 1SBV01284 <input type="checkbox"/> R1511	LS73P5 <input type="checkbox"/> C11 1SBV01285 <input type="checkbox"/> R1511	LS73P52C11 1SBV012852R1511	LS73P7 <input type="checkbox"/> C11 1SBV01287 <input type="checkbox"/> R1511
	Operation diagram				
Slow action contacts	Type Order code	LS73P4 <input type="checkbox"/> L02 1SBV01284 <input type="checkbox"/> R1302	LS73P5 <input type="checkbox"/> L02 1SBV01285 <input type="checkbox"/> R1302	LS73P52L02 1SBV012852R1302	LS73P7 <input type="checkbox"/> L02 1SBV01287 <input type="checkbox"/> R1302
	Operation diagram				
Slow action contacts	Type Order code	LS73P4 <input type="checkbox"/> L20 1SBV01284 <input type="checkbox"/> R1320	LS73P5 <input type="checkbox"/> L20 1SBV01285 <input type="checkbox"/> R1320	LS73P52L20 1SBV012852R1320	LS73P7 <input type="checkbox"/> L20 1SBV01287 <input type="checkbox"/> R1320
	Operation diagram				
Snap action contacts	Type Order code	LS73P4 <input type="checkbox"/> B02 1SBV01284 <input type="checkbox"/> R1202	LS73P5 <input type="checkbox"/> B02 1SBV01285 <input type="checkbox"/> R1202	LS73P52B02 1SBV012852R1202	LS73P7 <input type="checkbox"/> B02 1SBV01287 <input type="checkbox"/> R1202
	Operation diagram				
Weight (packing per unit)	kg	0.130	0.140	0.155	0.130

Special heads, accessories and special contact arrangement or particular function: please consult us.

Closed contact / Open contact

Dimensions (in mm)

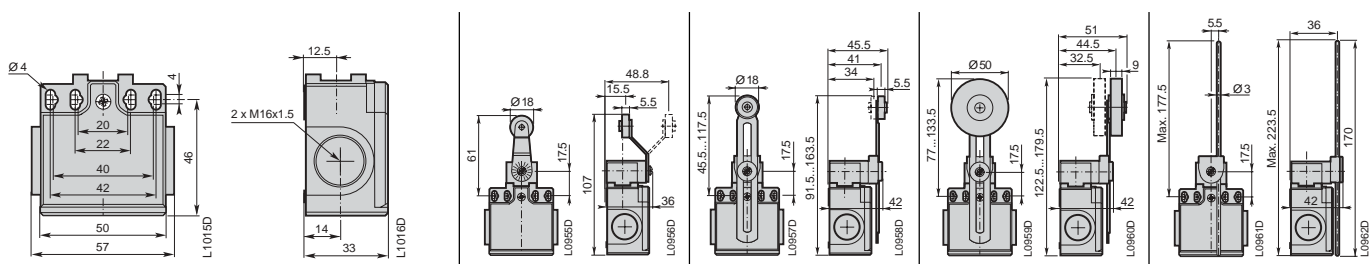

>> Description, Travel and Technical Data pages 4..11

>> Accessories page 48

>> Utilization Precautions page 51

LS73P... Limit Switches

Double Insulation - Plastic Casing IP65 - 60 mm Width
2 Cable Inlets M20 x 1.5 for ISO 20 Cable Gland

Fully Directional Translation Movement			Multidirectional		Pull Action
Adjustable $\varnothing 6$ polyamide rod lever	Adjustable $\varnothing 6$ fibre-glass rod lever	Adjustable $\varnothing 3$ square steel rod lever	Spring rod	Flexible rod with insulated end	Pull action with ring
1.5 m/s 0.1 N.m 0.32 N.m	1.5 m/s 0.1 N.m 0.32 N.m	1.5 m/s 0.1 N.m 0.32 N.m	1 m/s 0.12 N.m	1 m/s 0.12 N.m	0.5 m/s 30 N

LS73P73B11 1SBV012873R1211	LS73P74B11 1SBV012874R1211	LS73P78B11 1SBV012878R1211	LS73P91B11 1SBV012891R1211	LS73P92B11 1SBV012892R1211	LS73P98B11-A 1SBV012898R1211
LS73P73D11 1SBV012873R1411	LS73P74D11 1SBV012874R1411	LS73P78D11 1SBV012878R1411	LS73P91D11 1SBV012891R1411	LS73P92D11 1SBV012892R1411	LS73P98D11-A 1SBV012898R1411
LS73P73C11 1SBV012873R1511	LS73P74C11 1SBV012874R1511	LS73P78C11 1SBV012878R1511	LS73P91C11 1SBV012891R1511	LS73P92C11 1SBV012892R1511	
LS73P73L02 1SBV012873R1302	LS73P74L02 1SBV012874R1302	LS73P78L02 1SBV012878R1302	LS73P91L02 1SBV012891R1302	LS73P92L02 1SBV012892R1302	LS73P98L02-A 1SBV012898R1302
LS73P73L20 1SBV012873R1320	LS73P74L20 1SBV012874R1320	LS73P78L20 1SBV012878R1320	LS73P91L20 1SBV012891R1320	LS73P92L20 1SBV012892R1320	LS73P98L20-A 1SBV012898R1320
LS73P73B02 1SBV012873R1202	LS73P74B02 1SBV012874R1202	LS73P78B02 1SBV012878R1202	LS73P91B02 1SBV012891R1202	LS73P92B02 1SBV012892R1202	
0.145	0.145	0.125	0.110	0.115	0.145

☒ Special heads, accessories and special contact arrangement or particular function: please consult us.

■ Closed contact / □ Open contact

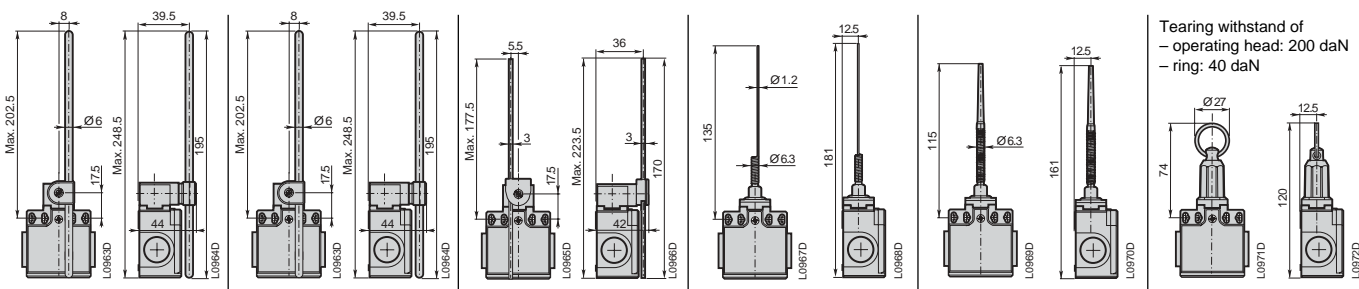

>> Description, Travel and Technical Data pages 4...11 >> Accessories page 48 >> Utilization Precautions page 51

LS75P... Limit Switches

Double Insulation - Plastic Casing IP65 - 60 mm Width
2 Cable Inlets for 1/2" NPT plastic adaptor

Movement to be detected:

- 1 cable inlet by 1/2" NPT plastic adaptor (delivered not mounted), and
- 1 cable inlet Pg11 for additional 1/2" NPT plastic adaptor (on request)

1/2" NPT plastic adaptors		
LSR1305	1SBV 04 7500 R1305	1 packet of 1 piece
LSR1305	1SBV 04 7500 T1305	1 packet of 10 pieces
LSR1305	1SBV 04 7500 W1305	1 packet of 50 pieces

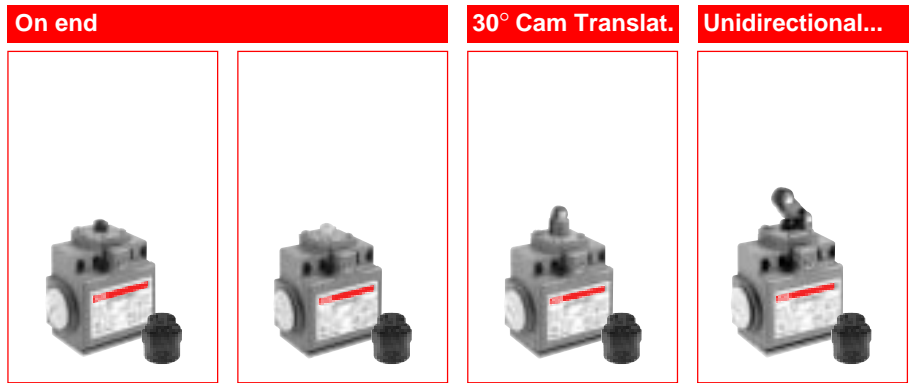

Actuator

	Plastic plain plunger	Steel plain plunger	Roller plunger	Plastic roller lever on plastic plunger
Conformity / \ominus (N.C. contact with positive opening operation)	-	-	-	-
Maximum actuation speed	0.5 m/s	0.5 m/s	0.3 m/s	1 m/s
Min. force / torque: - actuation	15 N	15 N	12 N	7 N
- positive opening operation	45 N	45 N	41 N	24 N

Additional Technical Data

Type and Order code to be completed with code <input type="checkbox"/>	-	-	Metal roller <input type="checkbox"/> 2 Plastic roller <input type="checkbox"/> 3	-	
Snap action contacts	Type Order code	LS75P10B11 1SBV012710R1211	LS75P11B11 1SBV012711R1211	LS75P1□B11 1SBV01271□R1211	LS75P30B11 1SBV012730R1211
	Operation diagram				
Non-overlapping Slow action contacts	Type Order code	LS75P10D11 1SBV012710R1411	LS75P11D11 1SBV012711R1411	LS75P1□D11 1SBV01271□R1411	LS75P30D11 1SBV012730R1411
	Operation diagram				
Overlapping Slow action contacts	Type Order code	LS75P10C11 1SBV012710R1511	LS75P11C11 1SBV012711R1511	LS75P1□C11 1SBV01271□R1511	LS75P30C11 1SBV012730R1511
	Operation diagram				
Slow action contacts	Type Order code	LS75P10L02 1SBV012710R1302	LS75P11L02 1SBV012711R1302	LS75P1□L02 1SBV01271□R1302	LS75P30L02 1SBV012730R1302
	Operation diagram				
Slow action contacts	Type Order code	LS75P10L20 1SBV012710R1320	LS75P11L20 1SBV012711R1320	LS75P1□L20 1SBV01271□R1320	LS75P30L20 1SBV012730R1320
	Operation diagram				
Snap action contacts	Type Order code	LS75P10B02 1SBV012710R1202	LS75P11B02 1SBV012711R1202	LS75P1□B02 1SBV01271□R1202	LS75P30B02 1SBV012730R1202
	Operation diagram				
Weight (packing per unit)	kg	0.102	0.107	0.112	0.107

Special heads, accessories and special contact arrangement or particular function: please consult us.

Closed contact / Open contact

Dimensions (in mm)

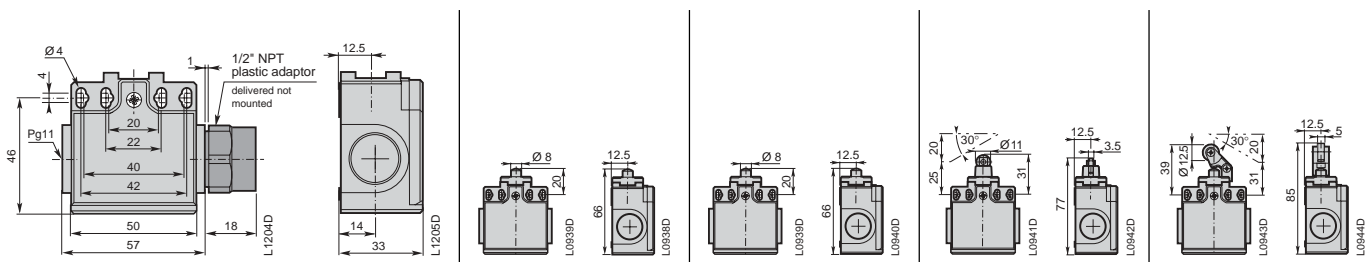

>> Description, Travel and Technical Data pages 4..11

>> Accessories page 48

>> Utilization Precautions page 51

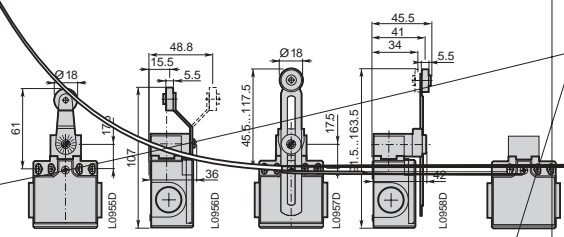
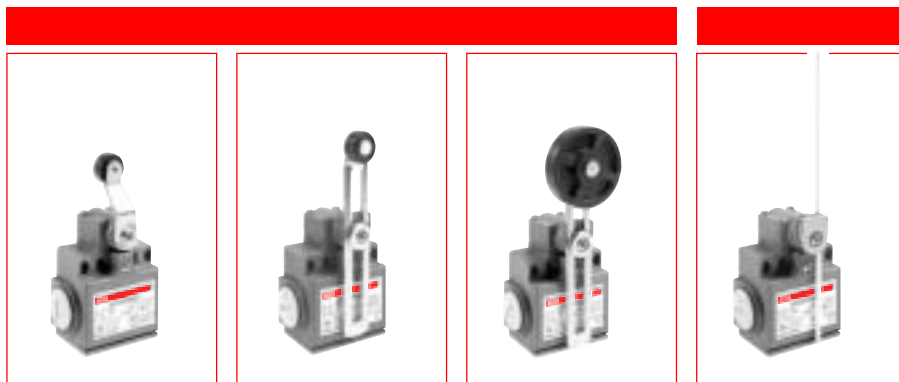

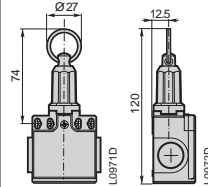
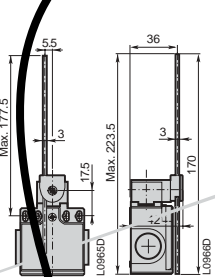
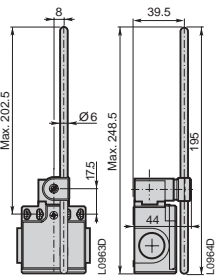
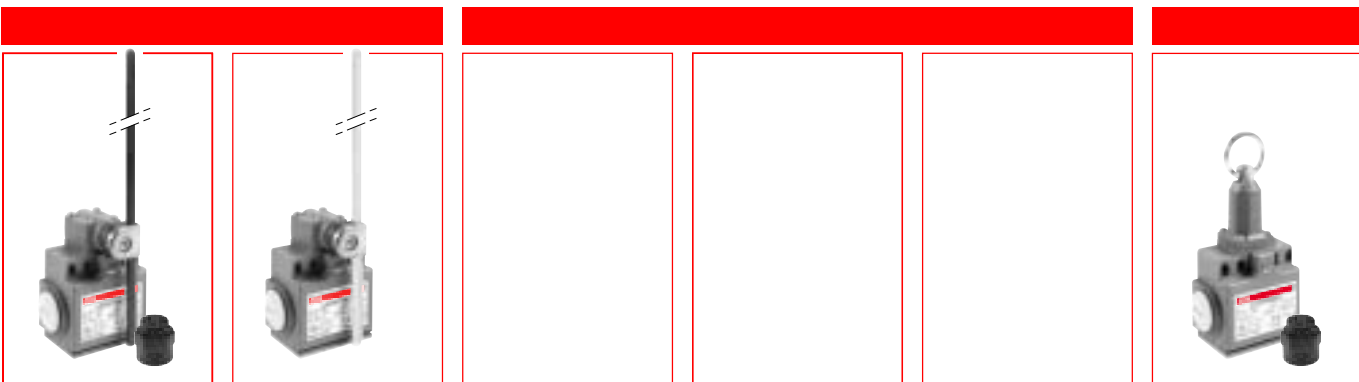

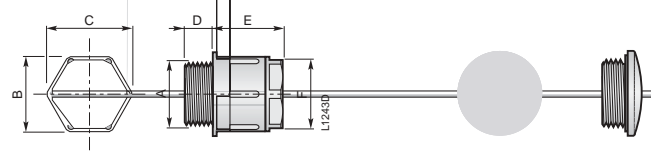
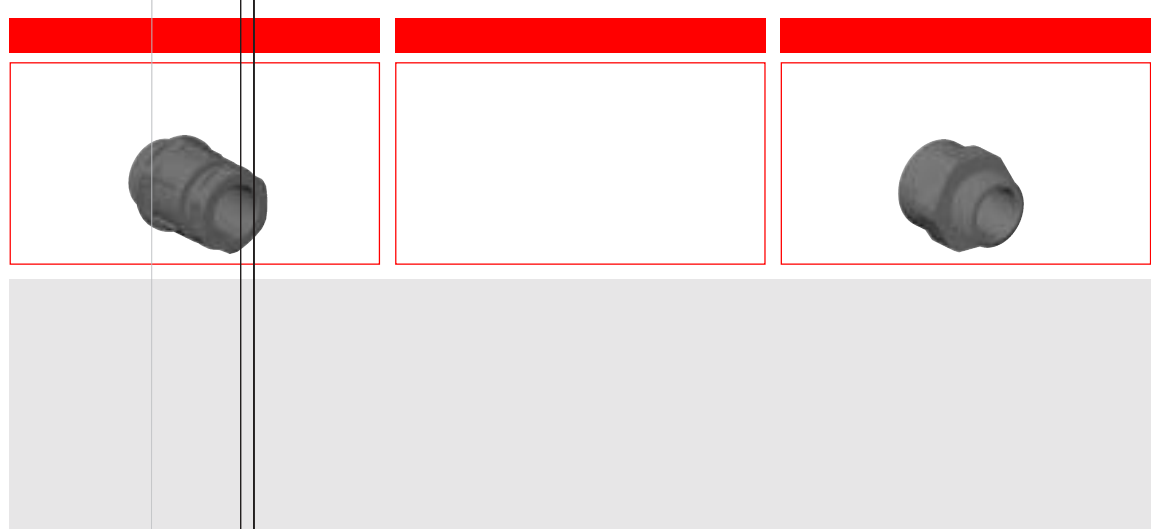
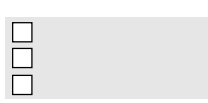
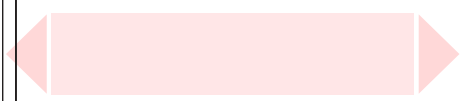
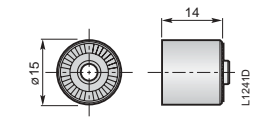

Limit Switches

EN 50047 Standard

The European Committee for Electrotechnical Standardization (CENELEC), which groups together 18 European countries, publishes EN standards. The present standard defines dimensions and mechanical data for limit switches (30 x 55 mm).

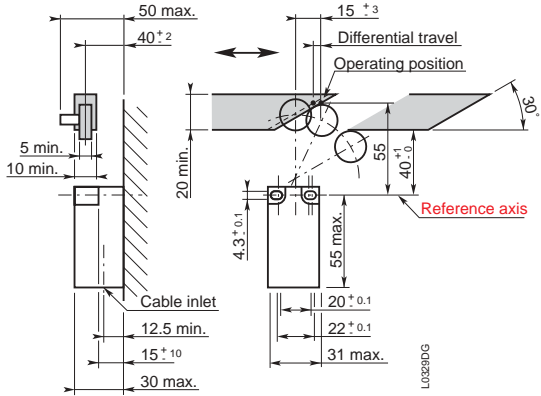

A Shape
Roller lever operating heads

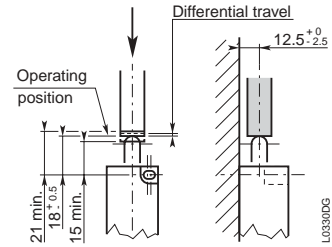

B Shape
Rounded plunger operating heads

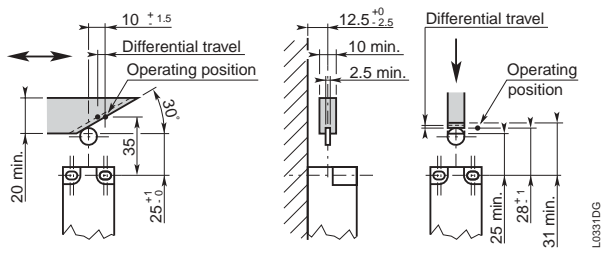

C Shape
Roller plunger operating heads

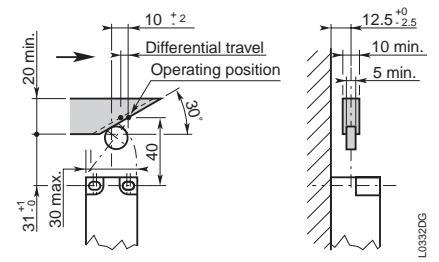

E Shape
Roller lever operating heads

LS Series Limit Switches

Terminology

Double Insulation

Class II materials, according to IEC 536, are designed with double insulation. This measure consists in doubling the functional insulation with an additional layer of insulation so as to eliminate the risk of electric shock and thus not having to protect elsewhere. No conductive part of "double insulated" material should be connected to a protective conductor.

Positive Opening Operation

A control switch, with one or more break-contact elements, has a positive opening operation when the switch actuator ensures full contact opening of the break-contact. For the part of travel that separates the contacts, there must be a positive drive, with no resilient member (e.g. springs), between the moving contacts and the point of the actuator to which the actuating force is applied.

Control switches with positive opening operation may be provided with either snap action or slow action contact elements. To use several contacts on the same control switch with positive opening operation, they must be electrically separated from each other, if not, only one may be used.

Every control switch with positive opening operation must be indelibly marked on the outside with the symbol: 

Snap Action

Snap action contacts are characterised by a release position that is distinct from the operating position (differential travel). Snap breaking of moving contacts is independent of the switch actuator's speed and contributes to regular electric performance even for slow switch actuator speeds.

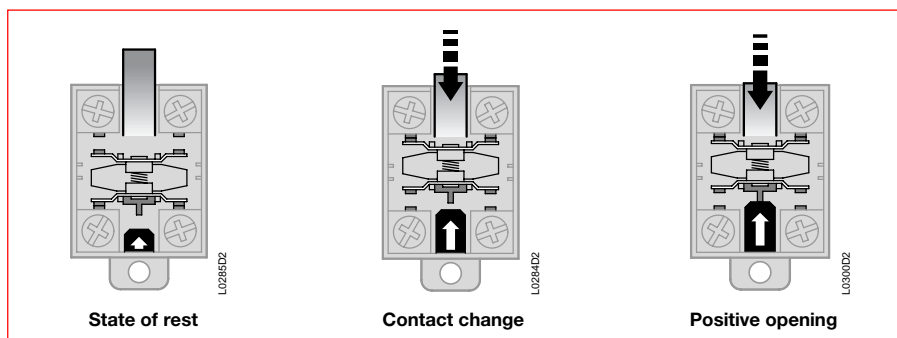

Slow Action

Slow action contacts are characterised by a release position that is the same as the operating position. The switch actuator's speed directly conditions the travel speed of contacts.

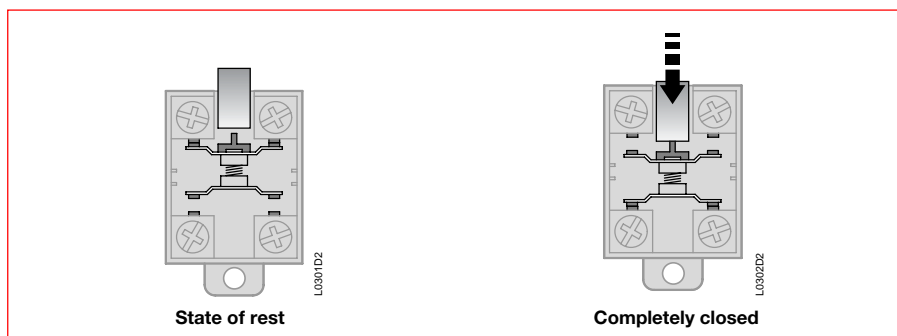

Contact shape according to IEC 60947-5-1. Change-over contact elements with 4 terminals must be indelibly marked **Za** or **Zb**. See figure opposite for contact representation.

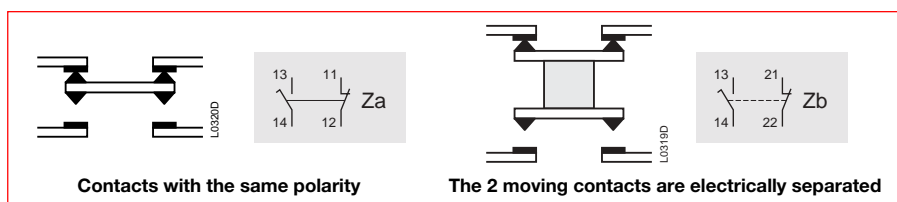

Utilization Category

AC-15: switching of electromagnetic loads of electromagnets using an alternating current (>72 VA).
DC-13: switching of electromagnets using a direct current.

Minimum Actuation Force / Torque

The minimum amount of force/torque that is to be applied to the switch actuator to produce a change in contact position.

Minimum Force / Torque to achieve Positive Opening Operation

The minimum amount of force/torque that is to be applied to the switch actuator to ensure positive opening operation of the N.C. contact.

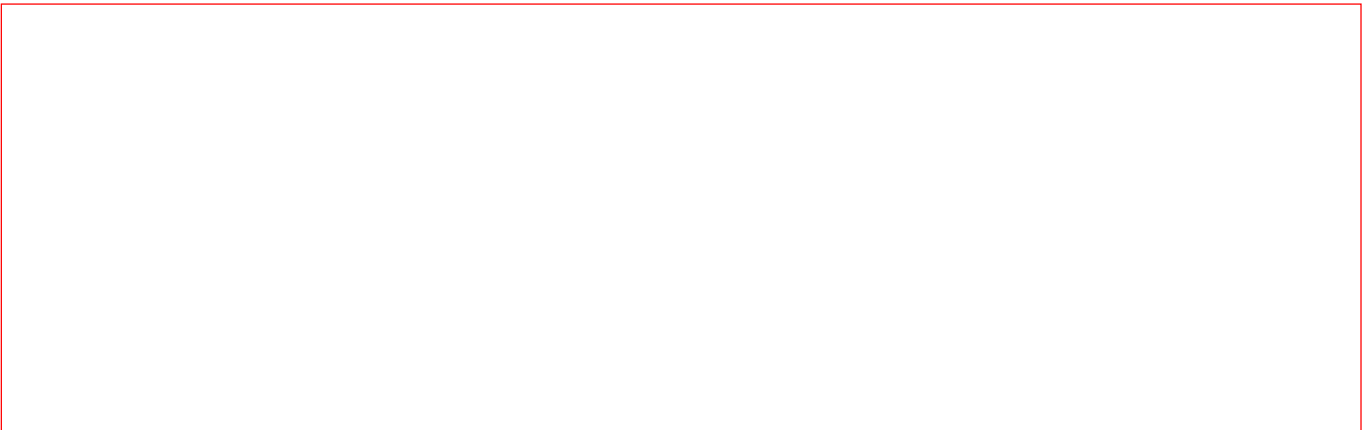
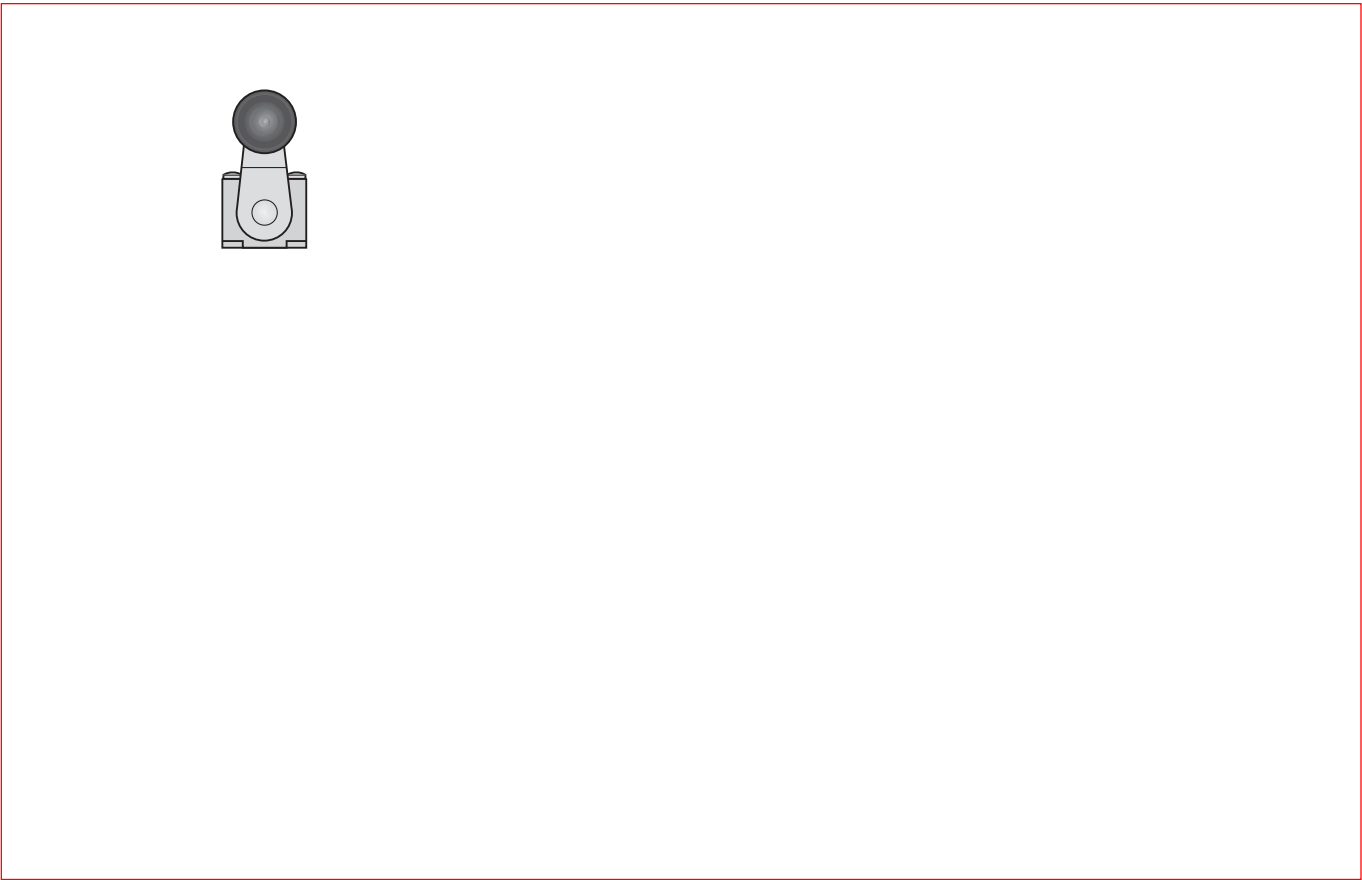

LS32M..., LS33M... and LS35M... Limit Switches

Metal Casing IP66 - 30 mm Width

LS32M with 1 cable inlet M16 x 1.5 for ISO 16 cable gland.
 LS33M with 1 cable inlet M20 x 1.5 for ISO 20 cable gland.
 LS35M with 1 cable inlet for 1/2" NPT cable gland.

Ordering Details

Contact blocks						Type	Order code	Unit weight kg
B11	D11	C11	L02	L20	B02			Packing

Steel plain plunger (zinc-plated)

1						LS32M11B11	1SBV 01 1911 R1211	0.180
	1					LS32M11D11	1SBV 01 1911 R1411	0.180
		1				LS32M11C11	1SBV 01 1911 R1511	0.180
			1			LS32M11L02	1SBV 01 1911 R1302	0.180
				1		LS32M11L20	1SBV 01 1911 R1320	0.180
					1	LS32M11B02	1SBV 01 1911 R1202	0.180
1						LS33M11B11	1SBV 01 3811 R1211	0.180
	1					LS33M11D11	1SBV 01 3811 R1411	0.180
		1				LS33M11C11	1SBV 01 3811 R1511	0.180
			1			LS33M11L02	1SBV 01 3811 R1302	0.180
				1		LS33M11L20	1SBV 01 3811 R1320	0.180
					1	LS33M11B02	1SBV 01 3811 R1202	0.180
1						LS35M11B11	1SBV 01 3711 R1211	0.180
	1					LS35M11D11	1SBV 01 3711 R1411	0.180
		1				LS35M11C11	1SBV 01 3711 R1511	0.180
			1			LS35M11L02	1SBV 01 3711 R1302	0.180
				1		LS35M11L20	1SBV 01 3711 R1320	0.180
					1	LS35M11B02	1SBV 01 3711 R1202	0.180

ø11 steel roller plunger (zinc-plated)

1						LS32M12B11	1SBV 01 1912 R1211	0.185
	1					LS32M12D11	1SBV 01 1912 R1411	0.185
		1				LS32M12C11	1SBV 01 1912 R1511	0.185
			1			LS32M12L02	1SBV 01 1912 R1302	0.185
				1		LS32M12L20	1SBV 01 1912 R1320	0.185
					1	LS32M12B02	1SBV 01 1912 R1202	0.185
1						LS33M12B11	1SBV 01 3812 R1211	0.185
	1					LS33M12D11	1SBV 01 3812 R1411	0.185
		1				LS33M12C11	1SBV 01 3812 R1511	0.185
			1			LS33M12L02	1SBV 01 3812 R1302	0.185
				1		LS33M12L20	1SBV 01 3812 R1320	0.185
					1	LS33M12B02	1SBV 01 3812 R1202	0.185
1						LS35M12B11	1SBV 01 3712 R1211	0.185
	1					LS35M12D11	1SBV 01 3712 R1411	0.185
		1				LS35M12C11	1SBV 01 3712 R1511	0.185
			1			LS35M12L02	1SBV 01 3712 R1302	0.185
				1		LS35M12L20	1SBV 01 3712 R1320	0.185
					1	LS35M12B02	1SBV 01 3712 R1202	0.185

ø11 plastic (polyacetal) roller plunger

1						LS32M13B11	1SBV 01 1913 R1211	0.185
	1					LS32M13D11	1SBV 01 1913 R1411	0.185
		1				LS32M13C11	1SBV 01 1913 R1511	0.185
			1			LS32M13L02	1SBV 01 1913 R1302	0.185
				1		LS32M13L20	1SBV 01 1913 R1320	0.185
					1	LS32M13B02	1SBV 01 1913 R1202	0.185
1						LS33M13B11	1SBV 01 3813 R1211	0.185
	1					LS33M13D11	1SBV 01 3813 R1411	0.185
		1				LS33M13C11	1SBV 01 3813 R1511	0.185
			1			LS33M13L02	1SBV 01 3813 R1302	0.185
				1		LS33M13L20	1SBV 01 3813 R1320	0.185
					1	LS33M13B02	1SBV 01 3813 R1202	0.185
1						LS35M13B11	1SBV 01 3713 R1211	0.185
	1					LS35M13D11	1SBV 01 3713 R1411	0.185
		1				LS35M13C11	1SBV 01 3713 R1511	0.185
			1			LS35M13L02	1SBV 01 3713 R1302	0.185
				1		LS35M13L20	1SBV 01 3713 R1320	0.185
					1	LS35M13B02	1SBV 01 3713 R1202	0.185

>> Technical Data, Dimensions page 12

>> Accessories page 76



LS32M11B11



LS32M12B11



LS32M13B11

LS32M..., LS33M... and LS35M... Limit Switches

Metal Casing IP66 - 30 mm Width

LS32M with 1 cable inlet M16 x 1.5 for ISO 16 cable gland.
 LS33M with 1 cable inlet M20 x 1.5 for ISO 20 cable gland.
 LS35M with 1 cable inlet for 1/2" NPT cable gland.

Ordering Details

Contact blocks						Type	Order code	Unit weight kg
B11	D11	C11	L02	L20	B02			Packing

Steel plain plunger (zinc-plated) with dust protection cup

1						LS32M14B11	1SBV 01 1914 R1211	0.180
	1					LS32M14D11	1SBV 01 1914 R1411	0.180
		1				LS32M14C11	1SBV 01 1914 R1511	0.180
			1			LS32M14L02	1SBV 01 1914 R1302	0.180
				1		LS32M14L20	1SBV 01 1914 R1320	0.180
					1	LS32M14B02	1SBV 01 1914 R1202	0.180
1						LS33M14B11	1SBV 01 3814 R1211	0.180
	1					LS33M14D11	1SBV 01 3814 R1411	0.180
		1				LS33M14C11	1SBV 01 3814 R1511	0.180
			1			LS33M14L02	1SBV 01 3814 R1302	0.180
				1		LS33M14L20	1SBV 01 3814 R1320	0.180
					1	LS33M14B02	1SBV 01 3814 R1202	0.180
1						LS35M14B11	1SBV 01 3714 R1211	0.180
	1					LS35M14D11	1SBV 01 3714 R1411	0.180
		1				LS35M14C11	1SBV 01 3714 R1511	0.180
			1			LS35M14L02	1SBV 01 3714 R1302	0.180
				1		LS35M14L20	1SBV 01 3714 R1320	0.180
					1	LS35M14B02	1SBV 01 3714 R1202	0.180

ø12.5 plastic (polyacetal) roller lever on steel plunger (zinc-plated)

1						LS32M31B11	1SBV 01 1931 R1211	0.175
	1					LS32M31D11	1SBV 01 1931 R1411	0.175
		1				LS32M31C11	1SBV 01 1931 R1511	0.175
			1			LS32M31L02	1SBV 01 1931 R1302	0.175
				1		LS32M31L20	1SBV 01 1931 R1320	0.175
					1	LS32M31B02	1SBV 01 1931 R1202	0.175
1						LS33M31B11	1SBV 01 3831 R1211	0.175
	1					LS33M31D11	1SBV 01 3831 R1411	0.175
		1				LS33M31C11	1SBV 01 3831 R1511	0.175
			1			LS33M31L02	1SBV 01 3831 R1302	0.175
				1		LS33M31L20	1SBV 01 3831 R1320	0.175
					1	LS33M31B02	1SBV 01 3831 R1202	0.175
1						LS35M31B11	1SBV 01 3731 R1211	0.175
	1					LS35M31D11	1SBV 01 3731 R1411	0.175
		1				LS35M31C11	1SBV 01 3731 R1511	0.175
			1			LS35M31L02	1SBV 01 3731 R1302	0.175
				1		LS35M31L20	1SBV 01 3731 R1320	0.175
					1	LS35M31B02	1SBV 01 3731 R1202	0.175

ø12.5 plastic (polyacetal) roller lever on steel plunger (zinc-plated)

1						LS32M32B11	1SBV 01 1932 R1211	0.175
	1					LS32M32D11	1SBV 01 1932 R1411	0.175
		1				LS32M32C11	1SBV 01 1932 R1511	0.175
			1			LS32M32L02	1SBV 01 1932 R1302	0.175
				1		LS32M32L20	1SBV 01 1932 R1320	0.175
					1	LS32M32B02	1SBV 01 1932 R1202	0.175
1						LS33M32B11	1SBV 01 3832 R1211	0.175
	1					LS33M32D11	1SBV 01 3832 R1411	0.175
		1				LS33M32C11	1SBV 01 3832 R1511	0.175
			1			LS33M32L02	1SBV 01 3832 R1302	0.175
				1		LS33M32L20	1SBV 01 3832 R1320	0.175
					1	LS33M32B02	1SBV 01 3832 R1202	0.175
1						LS35M32B11	1SBV 01 3732 R1211	0.175
	1					LS35M32D11	1SBV 01 3732 R1411	0.175
		1				LS35M32C11	1SBV 01 3732 R1511	0.175
			1			LS35M32L02	1SBV 01 3732 R1302	0.175
				1		LS35M32L20	1SBV 01 3732 R1320	0.175
					1	LS35M32B02	1SBV 01 3732 R1202	0.175

>> Technical Data, Dimensions pages 12, 13

>> Accessories page 76



LS32M14B11



LS32M31B11









LS32M32B11

LS32M..., LS33M... and LS35M... Limit Switches

Metal Casing IP66 - 30 mm Width

LS32M with 1 cable inlet M16 x 1.5 for ISO 16 cable gland.
 LS33M with 1 cable inlet M20 x 1.5 for ISO 20 cable gland.
 LS35M with 1 cable inlet for 1/2" NPT cable gland.

Ordering Details

Contact blocks						Type	Order code	Unit weight kg
								Packing
B11	D11	C11	L02	L20	B02			1 piece

Adjustable ø22 plastic (polyacetal) roller lever on steel plunger (zinc-plated)

1						LS32M38B11	1SBV 01 1938 R1211	0.180
	1					LS32M38D11	1SBV 01 1938 R1411	0.180
		1				LS32M38C11	1SBV 01 1938 R1511	0.180
			1			LS32M38L02	1SBV 01 1938 R1302	0.180
				1		LS32M38L20	1SBV 01 1938 R1320	0.180
					1	LS32M38B02	1SBV 01 1938 R1202	0.180
1						LS33M38B11	1SBV 01 3838 R1211	0.180
	1					LS33M38D11	1SBV 01 3838 R1411	0.180
		1				LS33M38C11	1SBV 01 3838 R1511	0.180
			1			LS33M38L02	1SBV 01 3838 R1302	0.180
				1		LS33M38L20	1SBV 01 3838 R1320	0.180
					1	LS33M38B02	1SBV 01 3838 R1202	0.180
1						LS35M38B11	1SBV 01 3738 R1211	0.180
	1					LS35M38D11	1SBV 01 3738 R1411	0.180
		1				LS35M38C11	1SBV 01 3738 R1511	0.180
			1			LS35M38L02	1SBV 01 3738 R1302	0.180
				1		LS35M38L20	1SBV 01 3738 R1320	0.180
					1	LS35M38B02	1SBV 01 3738 R1202	0.180

ø18 plastic (polyacetal) roller lever

1						LS32M41B11	1SBV 01 1941 R1211	0.230
	1					LS32M41D11	1SBV 01 1941 R1411	0.230
		1				LS32M41C11	1SBV 01 1941 R1511	0.230
			1			LS32M41L02	1SBV 01 1941 R1302	0.230
				1		LS32M41L20	1SBV 01 1941 R1320	0.230
					1	LS32M41B02	1SBV 01 1941 R1202	0.230
1						LS33M41B11	1SBV 01 3841 R1211	0.230
	1					LS33M41D11	1SBV 01 3841 R1411	0.230
		1				LS33M41C11	1SBV 01 3841 R1511	0.230
			1			LS33M41L02	1SBV 01 3841 R1302	0.230
				1		LS33M41L20	1SBV 01 3841 R1320	0.230
					1	LS33M41B02	1SBV 01 3841 R1202	0.230
1						LS35M41B11	1SBV 01 3741 R1211	0.230
	1					LS35M41D11	1SBV 01 3741 R1411	0.230
		1				LS35M41C11	1SBV 01 3741 R1511	0.230
			1			LS35M41L02	1SBV 01 3741 R1302	0.230
				1		LS35M41L20	1SBV 01 3741 R1320	0.230
					1	LS35M41B02	1SBV 01 3741 R1202	0.230

ø50 rubber roller lever

1						LS32M42B11	1SBV 01 1942 R1211	0.255
	1					LS32M42D11	1SBV 01 1942 R1411	0.255
		1				LS32M42C11	1SBV 01 1942 R1511	0.255
			1			LS32M42L02	1SBV 01 1942 R1302	0.255
				1		LS32M42L20	1SBV 01 1942 R1320	0.255
					1	LS32M42B02	1SBV 01 1942 R1202	0.255
1						LS33M42B11	1SBV 01 3842 R1211	0.255
	1					LS33M42D11	1SBV 01 3842 R1411	0.255
		1				LS33M42C11	1SBV 01 3842 R1511	0.255
			1			LS33M42L02	1SBV 01 3842 R1302	0.255
				1		LS33M42L20	1SBV 01 3842 R1320	0.255
					1	LS33M42B02	1SBV 01 3842 R1202	0.255
1						LS35M42B11	1SBV 01 3742 R1211	0.255
	1					LS35M42D11	1SBV 01 3742 R1411	0.255
		1				LS35M42C11	1SBV 01 3742 R1511	0.255
			1			LS35M42L02	1SBV 01 3742 R1302	0.255
				1		LS35M42L20	1SBV 01 3742 R1320	0.255
					1	LS35M42B02	1SBV 01 3742 R1202	0.255

>> Technical Data, Dimensions page 13

>> Accessories page 76



LS32M38B11

1SBC5 8572 1F030S



LS32M41B11

1SBC5 8573 1F030S

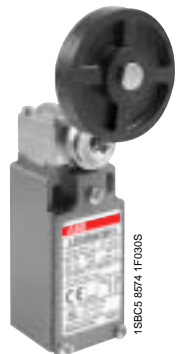

LS32M42B11

1SBC5 8574 1F030S

LS32M..., LS33M... and LS35M... Limit Switches

Metal Casing IP66 - 30 mm Width

LS32M with 1 cable inlet M16 x 1.5 for ISO 16 cable gland.
 LS33M with 1 cable inlet M20 x 1.5 for ISO 20 cable gland.
 LS35M with 1 cable inlet for 1/2" NPT cable gland.

Ordering Details

Contact blocks						Type	Order code	Unit weight kg Packing 1 piece
B11	D11	C11	L02	L20	B02			

ø18 steel roller lever (zinc-plated)

1						LS32M43B11	1SBV 01 1943 R1211	0.235
	1					LS32M43D11	1SBV 01 1943 R1411	0.235
		1				LS32M43C11	1SBV 01 1943 R1511	0.235
			1			LS32M43L02	1SBV 01 1943 R1302	0.235
				1		LS32M43L20	1SBV 01 1943 R1320	0.235
					1	LS32M43B02	1SBV 01 1943 R1202	0.235
1						LS33M43B11	1SBV 01 3843 R1211	0.235
	1					LS33M43D11	1SBV 01 3843 R1411	0.235
		1				LS33M43C11	1SBV 01 3843 R1511	0.235
			1			LS33M43L02	1SBV 01 3843 R1302	0.235
				1		LS33M43L20	1SBV 01 3843 R1320	0.235
					1	LS33M43B02	1SBV 01 3843 R1202	0.235
1						LS35M43B11	1SBV 01 3743 R1211	0.235
	1					LS35M43D11	1SBV 01 3743 R1411	0.235
		1				LS35M43C11	1SBV 01 3743 R1511	0.235
			1			LS35M43L02	1SBV 01 3743 R1302	0.235
				1		LS35M43L20	1SBV 01 3743 R1320	0.235
					1	LS35M43B02	1SBV 01 3743 R1202	0.235

ø18 plastic (polyacetal) roller with bent lever

1						LS32M45B11	1SBV 01 1945 R1211	0.245
	1					LS32M45D11	1SBV 01 1945 R1411	0.245
		1				LS32M45C11	1SBV 01 1945 R1511	0.245
			1			LS32M45L02	1SBV 01 1945 R1302	0.245
				1		LS32M45L20	1SBV 01 1945 R1320	0.245
					1	LS32M45B02	1SBV 01 1945 R1202	0.245
1						LS33M45B11	1SBV 01 3845 R1211	0.245
	1					LS33M45D11	1SBV 01 3845 R1411	0.245
		1				LS33M45C11	1SBV 01 3845 R1511	0.245
			1			LS33M45L02	1SBV 01 3845 R1302	0.245
				1		LS33M45L20	1SBV 01 3845 R1320	0.245
					1	LS33M45B02	1SBV 01 3845 R1202	0.245
1						LS35M45B11	1SBV 01 3745 R1211	0.245
	1					LS35M45D11	1SBV 01 3745 R1411	0.245
		1				LS35M45C11	1SBV 01 3745 R1511	0.245
			1			LS35M45L02	1SBV 01 3745 R1302	0.245
				1		LS35M45L20	1SBV 01 3745 R1320	0.245
					1	LS35M45B02	1SBV 01 3745 R1202	0.245

ø18 steel roller (zinc-plated) with bent lever

1						LS32M46B11	1SBV 01 1946 R1211	0.250
	1					LS32M46D11	1SBV 01 1946 R1411	0.250
		1				LS32M46C11	1SBV 01 1946 R1511	0.250
			1			LS32M46L02	1SBV 01 1946 R1302	0.250
				1		LS32M46L20	1SBV 01 1946 R1320	0.250
					1	LS32M46B02	1SBV 01 1946 R1202	0.250
1						LS33M46B11	1SBV 01 3846 R1211	0.250
	1					LS33M46D11	1SBV 01 3846 R1411	0.250
		1				LS33M46C11	1SBV 01 3846 R1511	0.250
			1			LS33M46L02	1SBV 01 3846 R1302	0.250
				1		LS33M46L20	1SBV 01 3846 R1320	0.250
					1	LS33M46B02	1SBV 01 3846 R1202	0.250
1						LS35M46B11	1SBV 01 3746 R1211	0.250
	1					LS35M46D11	1SBV 01 3746 R1411	0.250
		1				LS35M46C11	1SBV 01 3746 R1511	0.250
			1			LS35M46L02	1SBV 01 3746 R1302	0.250
				1		LS35M46L20	1SBV 01 3746 R1320	0.250
					1	LS35M46B02	1SBV 01 3746 R1202	0.250

>> Technical Data, Dimensions page 13

>> Accessories page 76



LS32M43B11

1SBCE5 9041 1F030S



LS32M45B11

1SBCE5 8676 1F030S



LS32M46B11

1SBCE5 9042 1F030S

LS32M..., LS33M... and LS35M... Limit Switches

Metal Casing IP66 - 30 mm Width

LS32M with 1 cable inlet M16 x 1.5 for ISO 16 cable gland.
 LS33M with 1 cable inlet M20 x 1.5 for ISO 20 cable gland.
 LS35M with 1 cable inlet for 1/2" NPT cable gland.

Ordering Details

Contact blocks						Type	Order code	Unit weight kg
B11	D11	C11	L02	L20	B02			Packing
								1 piece

Adjustable ø18 plastic (polyacetal) roller lever

1						LS32M51B11	1SBV 01 1951 R1211	0.240
	1					LS32M51D11	1SBV 01 1951 R1411	0.240
		1				LS32M51C11	1SBV 01 1951 R1511	0.240
			1			LS32M51L02	1SBV 01 1951 R1302	0.240
				1		LS32M51L20	1SBV 01 1951 R1320	0.240
					1	LS32M51B02	1SBV 01 1951 R1202	0.240
1						LS33M51B11	1SBV 01 3851 R1211	0.240
	1					LS33M51D11	1SBV 01 3851 R1411	0.240
		1				LS33M51C11	1SBV 01 3851 R1511	0.240
			1			LS33M51L02	1SBV 01 3851 R1302	0.240
				1		LS33M51L20	1SBV 01 3851 R1320	0.240
					1	LS33M51B02	1SBV 01 3851 R1202	0.240
1						LS35M51B11	1SBV 01 3751 R1211	0.240
	1					LS35M51D11	1SBV 01 3751 R1411	0.240
		1				LS35M51C11	1SBV 01 3751 R1511	0.240
			1			LS35M51L02	1SBV 01 3751 R1302	0.240
				1		LS35M51L20	1SBV 01 3751 R1320	0.240
					1	LS35M51B02	1SBV 01 3751 R1202	0.240

Adjustable ø50 rubber roller lever

1						LS32M52B11	1SBV 01 1952 R1211	0.265
	1					LS32M52D11	1SBV 01 1952 R1411	0.265
		1				LS32M52C11	1SBV 01 1952 R1511	0.265
			1			LS32M52L02	1SBV 01 1952 R1302	0.265
				1		LS32M52L20	1SBV 01 1952 R1320	0.265
					1	LS32M52B02	1SBV 01 1952 R1202	0.265
1						LS33M52B11	1SBV 01 3852 R1211	0.265
	1					LS33M52D11	1SBV 01 3852 R1411	0.265
		1				LS33M52C11	1SBV 01 3852 R1511	0.265
			1			LS33M52L02	1SBV 01 3852 R1302	0.265
				1		LS33M52L20	1SBV 01 3852 R1320	0.265
					1	LS33M52B02	1SBV 01 3852 R1202	0.265
1						LS35M52B11	1SBV 01 3752 R1211	0.265
	1					LS35M52D11	1SBV 01 3752 R1411	0.265
		1				LS35M52C11	1SBV 01 3752 R1511	0.265
			1			LS35M52L02	1SBV 01 3752 R1302	0.265
				1		LS35M52L20	1SBV 01 3752 R1320	0.265
					1	LS35M52B02	1SBV 01 3752 R1202	0.265

Adjustable ø18 steel roller lever (zinc-plated)

1						LS32M53B11	1SBV 01 1953 R1211	0.245
	1					LS32M53D11	1SBV 01 1953 R1411	0.245
		1				LS32M53C11	1SBV 01 1953 R1511	0.245
			1			LS32M53L02	1SBV 01 1953 R1302	0.245
				1		LS32M53L20	1SBV 01 1953 R1320	0.245
					1	LS32M53B02	1SBV 01 1953 R1202	0.245
1						LS33M53B11	1SBV 01 3853 R1211	0.245
	1					LS33M53D11	1SBV 01 3853 R1411	0.245
		1				LS33M53C11	1SBV 01 3853 R1511	0.245
			1			LS33M53L02	1SBV 01 3853 R1302	0.245
				1		LS33M53L20	1SBV 01 3853 R1320	0.245
					1	LS33M53B02	1SBV 01 3853 R1202	0.245
1						LS35M53B11	1SBV 01 3753 R1211	0.245
	1					LS35M53D11	1SBV 01 3753 R1411	0.245
		1				LS35M53C11	1SBV 01 3753 R1511	0.245
			1			LS35M53L02	1SBV 01 3753 R1302	0.245
				1		LS35M53L20	1SBV 01 3753 R1320	0.245
					1	LS35M53B02	1SBV 01 3753 R1202	0.245

>> Technical Data, Dimensions page 14

>> Accessories page 76



LS32M51B11

1SBCE5 8576 1F030S

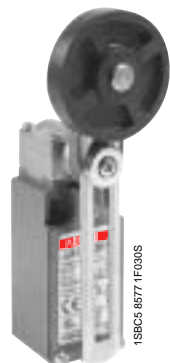

LS32M52B11

1SBCE5 8577 1F030S



LS32M53B11





1SBCE5 9043 1F030S

LS32M..., LS33M... and LS35M... Limit Switches

Metal Casing IP66 - 30 mm Width

LS32M with 1 cable inlet M16 x 1.5 for ISO 16 cable gland.
 LS33M with 1 cable inlet M20 x 1.5 for ISO 20 cable gland.
 LS35M with 1 cable inlet for 1/2" NPT cable gland.

Ordering Details

Contact blocks	Type	Order code	Unit weight kg Packing
 B11	 D11	 C11	 L02
 L20	 B02		

Adjustable lever (vertical and horizontal) with ø50 rubber roller

1				LS32M55B11	1SBV 01 1955 R1211	0.270
	1			LS32M55D11	1SBV 01 1955 R1411	0.270
		1		LS32M55C11	1SBV 01 1955 R1511	0.270
			1	LS32M55L02	1SBV 01 1955 R1302	0.270
				LS32M55L20	1SBV 01 1955 R1320	0.270
				LS32M55B02	1SBV 01 1955 R1202	0.270
1				LS33M55B11	1SBV 01 3855 R1211	0.270
	1			LS33M55D11	1SBV 01 3855 R1411	0.270
		1		LS33M55C11	1SBV 01 3855 R1511	0.270
			1	LS33M55L02	1SBV 01 3855 R1302	0.270
				LS33M55L20	1SBV 01 3855 R1320	0.270
				LS33M55B02	1SBV 01 3855 R1202	0.270
1				LS35M55B11	1SBV 01 3755 R1211	0.270
	1			LS35M55D11	1SBV 01 3755 R1411	0.270
		1		LS35M55C11	1SBV 01 3755 R1511	0.270
			1	LS35M55L02	1SBV 01 3755 R1302	0.270
				LS35M55L20	1SBV 01 3755 R1320	0.270
				LS35M55B02	1SBV 01 3755 R1202	0.270

Adjustable ø3 stainless steel rod lever

1				LS32M71B11	1SBV 01 1971 R1211	0.245
	1			LS32M71D11	1SBV 01 1971 R1411	0.245
		1		LS32M71C11	1SBV 01 1971 R1511	0.245
			1	LS32M71L02	1SBV 01 1971 R1302	0.245
				LS32M71L20	1SBV 01 1971 R1320	0.245
				LS32M71B02	1SBV 01 1971 R1202	0.245
1				LS33M71B11	1SBV 01 3871 R1211	0.245
	1			LS33M71D11	1SBV 01 3871 R1411	0.245
		1		LS33M71C11	1SBV 01 3871 R1511	0.245
			1	LS33M71L02	1SBV 01 3871 R1302	0.245
				LS33M71L20	1SBV 01 3871 R1320	0.245
				LS33M71B02	1SBV 01 3871 R1202	0.245
1				LS35M71B11	1SBV 01 3771 R1211	0.245
	1			LS35M71D11	1SBV 01 3771 R1411	0.245
		1		LS35M71C11	1SBV 01 3771 R1511	0.245
			1	LS35M71L02	1SBV 01 3771 R1302	0.245
				LS35M71L20	1SBV 01 3771 R1320	0.245
				LS35M71B02	1SBV 01 3771 R1202	0.245

Adjustable ø3 fibre-glass rod lever

1				LS32M72B11	1SBV 01 1972 R1211	0.235
	1			LS32M72D11	1SBV 01 1972 R1411	0.235
		1		LS32M72C11	1SBV 01 1972 R1511	0.235
			1	LS32M72L02	1SBV 01 1972 R1302	0.235
				LS32M72L20	1SBV 01 1972 R1320	0.235
				LS32M72B02	1SBV 01 1972 R1202	0.235
1				LS33M72B11	1SBV 01 3872 R1211	0.235
	1			LS33M72D11	1SBV 01 3872 R1411	0.235
		1		LS33M72C11	1SBV 01 3872 R1511	0.235
			1	LS33M72L02	1SBV 01 3872 R1302	0.235
				LS33M72L20	1SBV 01 3872 R1320	0.235
				LS33M72B02	1SBV 01 3872 R1202	0.235
1				LS35M72B11	1SBV 01 3772 R1211	0.235
	1			LS35M72D11	1SBV 01 3772 R1411	0.235
		1		LS35M72C11	1SBV 01 3772 R1511	0.235
			1	LS35M72L02	1SBV 01 3772 R1302	0.235
				LS35M72L20	1SBV 01 3772 R1320	0.235
				LS35M72B02	1SBV 01 3772 R1202	0.235



LS32M55B11



LS32M71B11



LS32M72B11

>> Technical Data, Dimensions page 14

>> Accessories page 76

LS32M..., LS33M... and LS35M... Limit Switches

Metal Casing IP66 - 30 mm Width

LS32M with 1 cable inlet M16 x 1.5 for ISO 16 cable gland.
 LS33M with 1 cable inlet M20 x 1.5 for ISO 20 cable gland.
 LS35M with 1 cable inlet for 1/2" NPT cable gland.

Ordering Details

Contact blocks						Type	Order code	Unit weight kg
B11	D11	C11	L02	L20	B02			Packing
								1 piece

Adjustable ø6 polyamide rod lever

1						LS32M73B11	1SBV 01 1973 R1211	0.255
	1					LS32M73D11	1SBV 01 1973 R1411	0.255
		1				LS32M73C11	1SBV 01 1973 R1511	0.255
			1			LS32M73L02	1SBV 01 1973 R1302	0.255
				1		LS32M73L20	1SBV 01 1973 R1320	0.255
					1	LS32M73B02	1SBV 01 1973 R1202	0.255
1						LS33M73B11	1SBV 01 3873 R1211	0.255
	1					LS33M73D11	1SBV 01 3873 R1411	0.255
		1				LS33M73C11	1SBV 01 3873 R1511	0.255
			1			LS33M73L02	1SBV 01 3873 R1302	0.255
				1		LS33M73L20	1SBV 01 3873 R1320	0.255
					1	LS33M73B02	1SBV 01 3873 R1202	0.255
1						LS35M73B11	1SBV 01 3773 R1211	0.255
	1					LS35M73D11	1SBV 01 3773 R1411	0.255
		1				LS35M73C11	1SBV 01 3773 R1511	0.255
			1			LS35M73L02	1SBV 01 3773 R1302	0.255
				1		LS35M73L20	1SBV 01 3773 R1320	0.255
					1	LS35M73B02	1SBV 01 3773 R1202	0.255

Adjustable ø6 fibre-glass rod lever

1						LS32M74B11	1SBV 01 1974 R1211	0.255
	1					LS32M74D11	1SBV 01 1974 R1411	0.255
		1				LS32M74C11	1SBV 01 1974 R1511	0.255
			1			LS32M74L02	1SBV 01 1974 R1302	0.255
				1		LS32M74L20	1SBV 01 1974 R1320	0.255
					1	LS32M74B02	1SBV 01 1974 R1202	0.255
1						LS33M74B11	1SBV 01 3874 R1211	0.255
	1					LS33M74D11	1SBV 01 3874 R1411	0.255
		1				LS33M74C11	1SBV 01 3874 R1511	0.255
			1			LS33M74L02	1SBV 01 3874 R1302	0.255
				1		LS33M74L20	1SBV 01 3874 R1320	0.255
					1	LS33M74B02	1SBV 01 3874 R1202	0.255
1						LS35M74B11	1SBV 01 3774 R1211	0.255
	1					LS35M74D11	1SBV 01 3774 R1411	0.255
		1				LS35M74C11	1SBV 01 3774 R1511	0.255
			1			LS35M74L02	1SBV 01 3774 R1302	0.255
				1		LS35M74L20	1SBV 01 3774 R1320	0.255
					1	LS35M74B02	1SBV 01 3774 R1202	0.255

Adjustable ø3 square steel rod lever (zinc-plated)

1						LS32M78B11	1SBV 01 1978 R1211	0.240
	1					LS32M78D11	1SBV 01 1978 R1411	0.240
		1				LS32M78C11	1SBV 01 1978 R1511	0.240
			1			LS32M78L02	1SBV 01 1978 R1302	0.240
				1		LS32M78L20	1SBV 01 1978 R1320	0.240
					1	LS32M78B02	1SBV 01 1978 R1202	0.240
1						LS33M78B11	1SBV 01 3878 R1211	0.240
	1					LS33M78D11	1SBV 01 3878 R1411	0.240
		1				LS33M78C11	1SBV 01 3878 R1511	0.240
			1			LS33M78L02	1SBV 01 3878 R1302	0.240
				1		LS33M78L20	1SBV 01 3878 R1320	0.240
					1	LS33M78B02	1SBV 01 3878 R1202	0.240
1						LS35M78B11	1SBV 01 3778 R1211	0.240
	1					LS35M78D11	1SBV 01 3778 R1411	0.240
		1				LS35M78C11	1SBV 01 3778 R1511	0.240
			1			LS35M78L02	1SBV 01 3778 R1302	0.240
				1		LS35M78L20	1SBV 01 3778 R1320	0.240
					1	LS35M78B02	1SBV 01 3778 R1202	0.240

>> Technical Data, Dimensions page 15

>> Accessories page 76

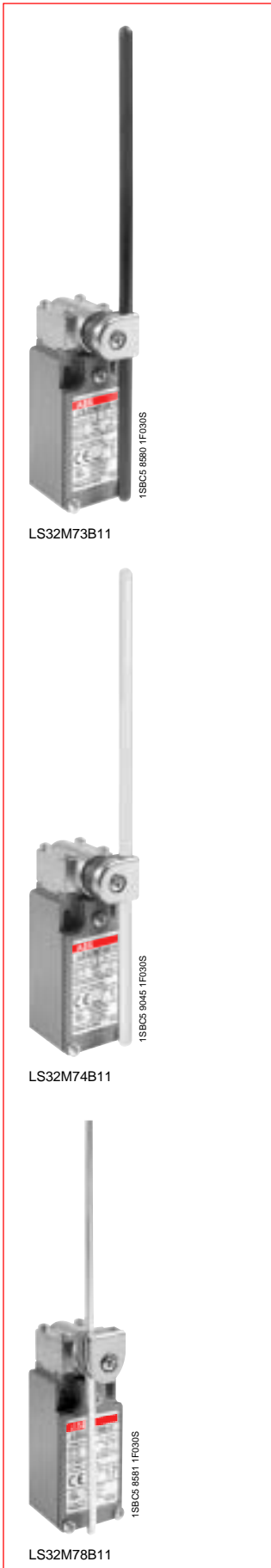

LS32M..., LS33M... and LS35M... Limit Switches

Metal Casing IP66 - 30 mm Width

LS32M with 1 cable inlet M16 x 1.5 for ISO 16 cable gland.
 LS33M with 1 cable inlet M20 x 1.5 for ISO 20 cable gland.
 LS35M with 1 cable inlet for 1/2" NPT cable gland.

Ordering Details

Contact blocks						Type	Order code	Unit weight kg Packing 1 piece
B11	D11	C11	L02	L20	B02			

Spring rod

1						LS32M91B11	1SBV 01 1991 R1211	0.180
	1					LS32M91D11	1SBV 01 1991 R1411	0.180
		1				LS32M91C11	1SBV 01 1991 R1511	0.180
			1			LS32M91L02	1SBV 01 1991 R1302	0.180
				1		LS32M91L20	1SBV 01 1991 R1320	0.180
					1	LS32M91B02	1SBV 01 1991 R1202	0.180
1						LS33M91B11	1SBV 01 3891 R1211	0.180
	1					LS33M91D11	1SBV 01 3891 R1411	0.180
		1				LS33M91C11	1SBV 01 3891 R1511	0.180
			1			LS33M91L02	1SBV 01 3891 R1302	0.180
				1		LS33M91L20	1SBV 01 3891 R1320	0.180
					1	LS33M91B02	1SBV 01 3891 R1202	0.180
1						LS35M91B11	1SBV 01 3791 R1211	0.180
	1					LS35M91D11	1SBV 01 3791 R1411	0.180
		1				LS35M91C11	1SBV 01 3791 R1511	0.180
			1			LS35M91L02	1SBV 01 3791 R1302	0.180
				1		LS35M91L20	1SBV 01 3791 R1320	0.180
					1	LS35M91B02	1SBV 01 3791 R1202	0.180

Flexible rod with insulated end

1						LS32M92B11	1SBV 01 1992 R1211	0.185
	1					LS32M92D11	1SBV 01 1992 R1411	0.185
		1				LS32M92C11	1SBV 01 1992 R1511	0.185
			1			LS32M92L02	1SBV 01 1992 R1302	0.185
				1		LS32M92L20	1SBV 01 1992 R1320	0.185
					1	LS32M92B02	1SBV 01 1992 R1202	0.185
1						LS33M92B11	1SBV 01 3892 R1211	0.185
	1					LS33M92D11	1SBV 01 3892 R1411	0.185
		1				LS33M92C11	1SBV 01 3892 R1511	0.185
			1			LS33M92L02	1SBV 01 3892 R1302	0.185
				1		LS33M92L20	1SBV 01 3892 R1320	0.185
					1	LS33M92B02	1SBV 01 3892 R1202	0.185
1						LS35M92B11	1SBV 01 3792 R1211	0.185
	1					LS35M92D11	1SBV 01 3792 R1411	0.185
		1				LS35M92C11	1SBV 01 3792 R1511	0.185
			1			LS35M92L02	1SBV 01 3792 R1302	0.185
				1		LS35M92L20	1SBV 01 3792 R1320	0.185
					1	LS35M92B02	1SBV 01 3792 R1202	0.185

Pull action with ring

1						LS32M98B11-A	1SBV 01 1998 R1211	0.215
	1					LS32M98D11-A	1SBV 01 1998 R1411	0.215
			1			LS32M98L02-A	1SBV 01 1998 R1302	0.215
				1		LS32M98L20-A	1SBV 01 1998 R1320	0.215
1						LS33M98B11-A	1SBV 01 3898 R1211	0.215
	1					LS33M98D11-A	1SBV 01 3898 R1411	0.215
			1			LS33M98L02-A	1SBV 01 3898 R1302	0.215
				1		LS33M98L20-A	1SBV 01 3898 R1320	0.215
1						LS35M98B11-A	1SBV 01 3798 R1211	0.215
	1					LS35M98D11-A	1SBV 01 3798 R1411	0.215
			1			LS35M98L02-A	1SBV 01 3798 R1302	0.215
				1		LS35M98L20-A	1SBV 01 3798 R1320	0.215



LS32M91B11



LS32M92B11



LS32M98B11-A

>> Technical Data, Dimensions page 15

>> Accessories page 76

LS72M..., LS73M... and LS75M... Limit Switches

Metal Casing IP66 - 60 mm Width

LS72M with 3 cable inlets M16 x 1.5 for ISO 16 cable gland.
 LS73M with 3 cable inlets M20 x 1.5 for ISO 20 cable gland.
 LS75M with 3 cable inlets for 1/2" NPT cable gland.

Ordering Details

Contact blocks	Type	Order code	Unit weight kg
 B11			Packing
 D11			1 piece
 C11			
 L02			
 L20			
 B02			

Steel plain plunger (zinc-plated)

1		LS72M11B11	1SBV 01 4311 R1211	0.270	
	1	LS72M11D11	1SBV 01 4311 R1411	0.270	
		1	LS72M11C11	1SBV 01 4311 R1511	0.270
		1	LS72M11L02	1SBV 01 4311 R1302	0.270
		1	LS72M11L20	1SBV 01 4311 R1320	0.270
		1	LS72M11B02	1SBV 01 4311 R1202	0.270
1		LS73M11B11	1SBV 01 5211 R1211	0.270	
	1	LS73M11D11	1SBV 01 5211 R1411	0.270	
		1	LS73M11C11	1SBV 01 5211 R1511	0.270
		1	LS73M11L02	1SBV 01 5211 R1302	0.270
		1	LS73M11L20	1SBV 01 5211 R1320	0.270
		1	LS73M11B02	1SBV 01 5211 R1202	0.270
1		LS75M11B11	1SBV 01 5111 R1211	0.270	
	1	LS75M11D11	1SBV 01 5111 R1411	0.270	
		1	LS75M11C11	1SBV 01 5111 R1511	0.270
		1	LS75M11L02	1SBV 01 5111 R1302	0.270
		1	LS75M11L20	1SBV 01 5111 R1320	0.270
		1	LS75M11B02	1SBV 01 5111 R1202	0.270

ø11 steel roller plunger (zinc-plated)

1		LS72M12B11	1SBV 01 4312 R1211	0.280	
	1	LS72M12D11	1SBV 01 4312 R1411	0.280	
		1	LS72M12C11	1SBV 01 4312 R1511	0.280
		1	LS72M12L02	1SBV 01 4312 R1302	0.280
		1	LS72M12L20	1SBV 01 4312 R1320	0.280
		1	LS72M12B02	1SBV 01 4312 R1202	0.280
1		LS73M12B11	1SBV 01 5212 R1211	0.280	
	1	LS73M12D11	1SBV 01 5212 R1411	0.280	
		1	LS73M12C11	1SBV 01 5212 R1511	0.280
		1	LS73M12L02	1SBV 01 5212 R1302	0.280
		1	LS73M12L20	1SBV 01 5212 R1320	0.280
		1	LS73M12B02	1SBV 01 5212 R1202	0.280
1		LS75M12B11	1SBV 01 5112 R1211	0.280	
	1	LS75M12D11	1SBV 01 5112 R1411	0.280	
		1	LS75M12C11	1SBV 01 5112 R1511	0.280
		1	LS75M12L02	1SBV 01 5112 R1302	0.280
		1	LS75M12L20	1SBV 01 5112 R1320	0.280
		1	LS75M12B02	1SBV 01 5112 R1202	0.280

ø11 plastic (polyacetal) roller plunger

1		LS72M13B11	1SBV 01 4313 R1211	0.275	
	1	LS72M13D11	1SBV 01 4313 R1411	0.275	
		1	LS72M13C11	1SBV 01 4313 R1511	0.275
		1	LS72M13L02	1SBV 01 4313 R1302	0.275
		1	LS72M13L20	1SBV 01 4313 R1320	0.275
		1	LS72M13B02	1SBV 01 4313 R1202	0.275
1		LS73M13B11	1SBV 01 5213 R1211	0.275	
	1	LS73M13D11	1SBV 01 5213 R1411	0.275	
		1	LS73M13C11	1SBV 01 5213 R1511	0.275
		1	LS73M13L02	1SBV 01 5213 R1302	0.275
		1	LS73M13L20	1SBV 01 5213 R1320	0.275
		1	LS73M13B02	1SBV 01 5213 R1202	0.275
1		LS75M13B11	1SBV 01 5113 R1211	0.275	
	1	LS75M13D11	1SBV 01 5113 R1411	0.275	
		1	LS75M13C11	1SBV 01 5113 R1511	0.275
		1	LS75M13L02	1SBV 01 5113 R1302	0.275
		1	LS75M13L20	1SBV 01 5113 R1320	0.275
		1	LS75M13B02	1SBV 01 5113 R1202	0.275

>> Technical Data, Dimensions page 24

>> Accessories page 76

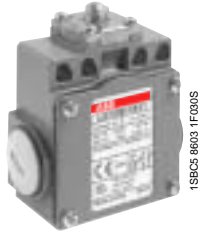

LS72M11B11

1SBC5 8603 1F030S



LS72M12B11

1SBC5 8604 1F030S



LS72M13B11







1SBC5 9046 1F030S

LS72M..., LS73M... and LS75M... Limit Switches

Metal Casing IP66 - 60 mm Width

LS72M with 3 cable inlets M16 x 1.5 for ISO 16 cable gland.
 LS73M with 3 cable inlets M20 x 1.5 for ISO 20 cable gland.
 LS75M with 3 cable inlets for 1/2" NPT cable gland.

Ordering Details

Contact blocks	Type	Order code	Unit weight kg Packing
 B11			1 piece
 D11			
 C11			
 L02			
 L20			
 B02			

ø12.5 plastic (polyacetal) roller lever on steel plunger (zinc-plated)

1			LS72M31B11	1SBV 01 4331 R1211	0.265		
	1		LS72M31D11	1SBV 01 4331 R1411	0.265		
		1	LS72M31C11	1SBV 01 4331 R1511	0.265		
			1	LS72M31L02	1SBV 01 4331 R1302	0.265	
				1	LS72M31L20	1SBV 01 4331 R1320	0.265
				1	LS72M31B02	1SBV 01 4331 R1202	0.265
1			LS73M31B11	1SBV 01 5231 R1211	0.265		
	1		LS73M31D11	1SBV 01 5231 R1411	0.265		
		1	LS73M31C11	1SBV 01 5231 R1511	0.265		
			1	LS73M31L02	1SBV 01 5231 R1302	0.265	
			1	LS73M31L20	1SBV 01 5231 R1320	0.265	
				1	LS73M31B02	1SBV 01 5231 R1202	0.265
1			LS75M31B11	1SBV 01 5131 R1211	0.265		
	1		LS75M31D11	1SBV 01 5131 R1411	0.265		
		1	LS75M31C11	1SBV 01 5131 R1511	0.265		
			1	LS75M31L02	1SBV 01 5131 R1302	0.265	
			1	LS75M31L20	1SBV 01 5131 R1320	0.265	
				1	LS75M31B02	1SBV 01 5131 R1202	0.265

ø12.5 plastic (polyacetal) roller lever on steel plunger (zinc-plated) with dust protection cup

1			LS72M35B11	1SBV 01 4335 R1211	0.265		
	1		LS72M35D11	1SBV 01 4335 R1411	0.265		
		1	LS72M35C11	1SBV 01 4335 R1511	0.265		
			1	LS72M35L02	1SBV 01 4335 R1302	0.265	
			1	LS72M35L20	1SBV 01 4335 R1320	0.265	
				1	LS72M35B02	1SBV 01 4335 R1202	0.265
1			LS73M35B11	1SBV 01 5235 R1211	0.265		
	1		LS73M35D11	1SBV 01 5235 R1411	0.265		
		1	LS73M35C11	1SBV 01 5235 R1511	0.265		
			1	LS73M35L02	1SBV 01 5235 R1302	0.265	
			1	LS73M35L20	1SBV 01 5235 R1320	0.265	
				1	LS73M35B02	1SBV 01 5235 R1202	0.265
1			LS75M35B11	1SBV 01 5135 R1211	0.265		
	1		LS75M35D11	1SBV 01 5135 R1411	0.265		
		1	LS75M35C11	1SBV 01 5135 R1511	0.265		
			1	LS75M35L02	1SBV 01 5135 R1302	0.265	
			1	LS75M35L20	1SBV 01 5135 R1320	0.265	
				1	LS75M35B02	1SBV 01 5135 R1202	0.265

Adjustable ø22 plastic (polyacetal) roller lever on steel plunger (zinc-plated)

1			LS72M38B11	1SBV 01 4338 R1211	0.270		
	1		LS72M38D11	1SBV 01 4338 R1411	0.270		
		1	LS72M38C11	1SBV 01 4338 R1511	0.270		
			1	LS72M38L02	1SBV 01 4338 R1302	0.270	
			1	LS72M38L20	1SBV 01 4338 R1320	0.270	
				1	LS72M38B02	1SBV 01 4338 R1202	0.270
1			LS73M38B11	1SBV 01 5238 R1211	0.270		
	1		LS73M38D11	1SBV 01 5238 R1411	0.270		
		1	LS73M38C11	1SBV 01 5238 R1511	0.270		
			1	LS73M38L02	1SBV 01 5238 R1302	0.270	
			1	LS73M38L20	1SBV 01 5238 R1320	0.270	
				1	LS73M38B02	1SBV 01 5238 R1202	0.270
1			LS75M38B11	1SBV 01 5138 R1211	0.270		
	1		LS75M38D11	1SBV 01 5138 R1411	0.270		
		1	LS75M38C11	1SBV 01 5138 R1511	0.270		
			1	LS75M38L02	1SBV 01 5138 R1302	0.270	
			1	LS75M38L20	1SBV 01 5138 R1320	0.270	
				1	LS75M38B02	1SBV 01 5138 R1202	0.270

>> Technical Data, Dimensions pages 24, 25

>> Accessories page 76

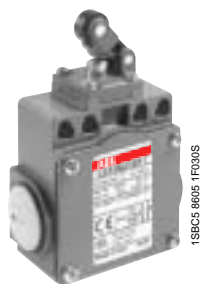

LS72M31B11

1SBCE5 8635 1F030S

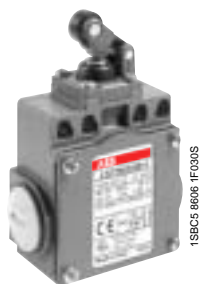

LS72M35B11

1SBCE5 8636 1F030S

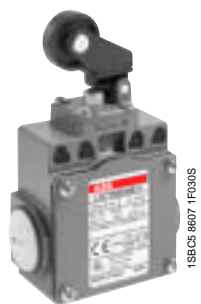

LS72M38B11

1SBCE5 8637 1F030S

LS72M..., LS73M... and LS75M... Limit Switches

Metal Casing IP66 - 60 mm Width

LS72M with 3 cable inlets M16 x 1.5 for ISO 16 cable gland.
 LS73M with 3 cable inlets M20 x 1.5 for ISO 20 cable gland.
 LS75M with 3 cable inlets for 1/2" NPT cable gland.

Ordering Details

Contact blocks						Type	Order code	Unit weight kg
B11	D11	C11	L02	L20	B02			Packing 1 piece
ø18 plastic (polyacetal) roller lever								
1						LS72M41B11	1SBV 01 4341 R1211	0.320
	1					LS72M41D11	1SBV 01 4341 R1411	0.320
		1				LS72M41C11	1SBV 01 4341 R1511	0.320
			1			LS72M41L02	1SBV 01 4341 R1302	0.320
				1		LS72M41L20	1SBV 01 4341 R1320	0.320
					1	LS72M41B02	1SBV 01 4341 R1202	0.320
1						LS73M41B11	1SBV 01 5241 R1211	0.320
	1					LS73M41D11	1SBV 01 5241 R1411	0.320
		1				LS73M41C11	1SBV 01 5241 R1511	0.320
			1			LS73M41L02	1SBV 01 5241 R1302	0.320
				1		LS73M41L20	1SBV 01 5241 R1320	0.320
					1	LS73M41B02	1SBV 01 5241 R1202	0.320
1						LS75M41B11	1SBV 01 5141 R1211	0.320
	1					LS75M41D11	1SBV 01 5141 R1411	0.320
		1				LS75M41C11	1SBV 01 5141 R1511	0.320
			1			LS75M41L02	1SBV 01 5141 R1302	0.320
				1		LS75M41L20	1SBV 01 5141 R1320	0.320
					1	LS75M41B02	1SBV 01 5141 R1202	0.320
ø50 rubber roller lever								
1						LS72M42B11	1SBV 01 4342 R1211	0.345
	1					LS72M42D11	1SBV 01 4342 R1411	0.345
		1				LS72M42C11	1SBV 01 4342 R1511	0.345
			1			LS72M42L02	1SBV 01 4342 R1302	0.345
				1		LS72M42L20	1SBV 01 4342 R1320	0.345
					1	LS72M42B02	1SBV 01 4342 R1202	0.345
1						LS73M42B11	1SBV 01 5242 R1211	0.345
	1					LS73M42D11	1SBV 01 5242 R1411	0.345
		1				LS73M42C11	1SBV 01 5242 R1511	0.345
			1			LS73M42L02	1SBV 01 5242 R1302	0.345
				1		LS73M42L20	1SBV 01 5242 R1320	0.345
					1	LS73M42B02	1SBV 01 5242 R1202	0.345
1						LS75M42B11	1SBV 01 5142 R1211	0.345
	1					LS75M42D11	1SBV 01 5142 R1411	0.345
		1				LS75M42C11	1SBV 01 5142 R1511	0.345
			1			LS75M42L02	1SBV 01 5142 R1302	0.345
				1		LS75M42L20	1SBV 01 5142 R1320	0.345
					1	LS75M42B02	1SBV 01 5142 R1202	0.345
ø18 steel roller lever (zinc-plated)								
1						LS72M43B11	1SBV 01 4343 R1211	0.325
	1					LS72M43D11	1SBV 01 4343 R1411	0.325
		1				LS72M43C11	1SBV 01 4343 R1511	0.325
			1			LS72M43L02	1SBV 01 4343 R1302	0.325
				1		LS72M43L20	1SBV 01 4343 R1320	0.325
					1	LS72M43B02	1SBV 01 4343 R1202	0.325
1						LS73M43B11	1SBV 01 5243 R1211	0.325
	1					LS73M43D11	1SBV 01 5243 R1411	0.325
		1				LS73M43C11	1SBV 01 5243 R1511	0.325
			1			LS73M43L02	1SBV 01 5243 R1302	0.325
				1		LS73M43L20	1SBV 01 5243 R1320	0.325
					1	LS73M43B02	1SBV 01 5243 R1202	0.325
1						LS75M43B11	1SBV 01 5143 R1211	0.325
	1					LS75M43D11	1SBV 01 5143 R1411	0.325
		1				LS75M43C11	1SBV 01 5143 R1511	0.325
			1			LS75M43L02	1SBV 01 5143 R1302	0.325
				1		LS75M43L20	1SBV 01 5143 R1320	0.325
					1	LS75M43B02	1SBV 01 5143 R1202	0.325

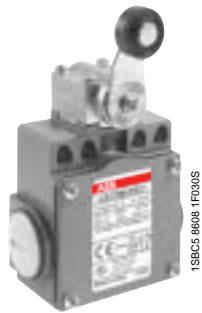

LS72M41B11

1SBC5 8808 1F030S

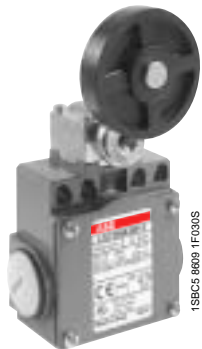

LS72M42B11

1SBC5 8809 1F030S

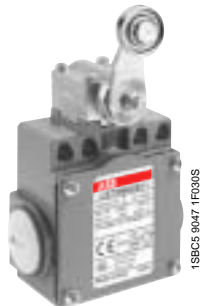

LS72M43B11







1SBC5 8047 1F030S

LS72M..., LS73M... and LS75M... Limit Switches

Metal Casing IP66 - 60 mm Width

LS72M with 3 cable inlets M16 x 1.5 for ISO 16 cable gland.
 LS73M with 3 cable inlets M20 x 1.5 for ISO 20 cable gland.
 LS75M with 3 cable inlets for 1/2" NPT cable gland.

Ordering Details

Contact blocks	Type	Order code	Unit weight kg Packing
 B11	 D11	 C11	 L02
 L20	 B02		

ø18 plastic (polyacetal) roller with bent lever

1					LS72M45B11	1SBV 01 4345 R1211	0.335
	1				LS72M45D11	1SBV 01 4345 R1411	0.335
		1			LS72M45C11	1SBV 01 4345 R1511	0.335
			1		LS72M45L02	1SBV 01 4345 R1302	0.335
				1	LS72M45L20	1SBV 01 4345 R1320	0.335
					LS72M45B02	1SBV 01 4345 R1202	0.335
1					LS73M45B11	1SBV 01 5245 R1211	0.335
	1				LS73M45D11	1SBV 01 5245 R1411	0.335
		1			LS73M45C11	1SBV 01 5245 R1511	0.335
			1		LS73M45L02	1SBV 01 5245 R1302	0.335
				1	LS73M45L20	1SBV 01 5245 R1320	0.335
					LS73M45B02	1SBV 01 5245 R1202	0.335
1					LS75M45B11	1SBV 01 5145 R1211	0.335
	1				LS75M45D11	1SBV 01 5145 R1411	0.335
		1			LS75M45C11	1SBV 01 5145 R1511	0.335
			1		LS75M45L02	1SBV 01 5145 R1302	0.335
				1	LS75M45L20	1SBV 01 5145 R1320	0.335
					LS75M45B02	1SBV 01 5145 R1202	0.335

ø18 steel roller (zinc-plated) with bent lever

1					LS72M46B11	1SBV 01 4346 R1211	0.340
	1				LS72M46D11	1SBV 01 4346 R1411	0.340
		1			LS72M46C11	1SBV 01 4346 R1511	0.340
			1		LS72M46L02	1SBV 01 4346 R1302	0.340
				1	LS72M46L20	1SBV 01 4346 R1320	0.340
					LS72M46B02	1SBV 01 4346 R1202	0.340
1					LS73M46B11	1SBV 01 5246 R1211	0.340
	1				LS73M46D11	1SBV 01 5246 R1411	0.340
		1			LS73M46C11	1SBV 01 5246 R1511	0.340
			1		LS73M46L02	1SBV 01 5246 R1302	0.340
				1	LS73M46L20	1SBV 01 5246 R1320	0.340
					LS73M46B02	1SBV 01 5246 R1202	0.340
1					LS75M46B11	1SBV 01 5146 R1211	0.340
	1				LS75M46D11	1SBV 01 5146 R1411	0.340
		1			LS75M46C11	1SBV 01 5146 R1511	0.340
			1		LS75M46L02	1SBV 01 5146 R1302	0.340
				1	LS75M46L20	1SBV 01 5146 R1320	0.340
					LS75M46B02	1SBV 01 5146 R1202	0.340

Adjustable ø18 plastic (polyacetal) roller lever

1					LS72M51B11	1SBV 01 4351 R1211	0.335
	1				LS72M51D11	1SBV 01 4351 R1411	0.335
		1			LS72M51C11	1SBV 01 4351 R1511	0.335
			1		LS72M51L02	1SBV 01 4351 R1302	0.335
				1	LS72M51L20	1SBV 01 4351 R1320	0.335
					LS72M51B02	1SBV 01 4351 R1202	0.335
1					LS73M51B11	1SBV 01 5251 R1211	0.335
	1				LS73M51D11	1SBV 01 5251 R1411	0.335
		1			LS73M51C11	1SBV 01 5251 R1511	0.335
			1		LS73M51L02	1SBV 01 5251 R1302	0.335
				1	LS73M51L20	1SBV 01 5251 R1320	0.335
					LS73M51B02	1SBV 01 5251 R1202	0.335
1					LS75M51B11	1SBV 01 5151 R1211	0.335
	1				LS75M51D11	1SBV 01 5151 R1411	0.335
		1			LS75M51C11	1SBV 01 5151 R1511	0.335
			1		LS75M51L02	1SBV 01 5151 R1302	0.335
				1	LS75M51L20	1SBV 01 5151 R1320	0.335
					LS75M51B02	1SBV 01 5151 R1202	0.335

>> Technical Data, Dimensions page 25

>> Accessories page 76

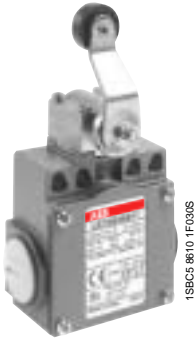

LS72M45B11

1SBC5 8610 1F030S

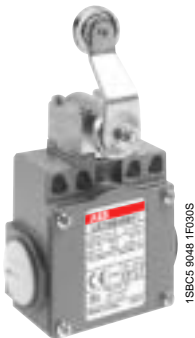

LS72M46B11

1SBC5 8616 1F030S

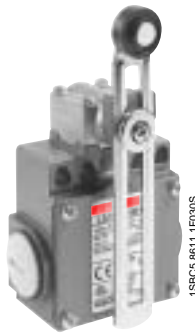

LS72M51B11







1SBC5 8611 1F030S

LS72M..., LS73M... and LS75M... Limit Switches

Metal Casing IP66 - 60 mm Width

LS72M with 3 cable inlets M16 x 1.5 for ISO 16 cable gland.
 LS73M with 3 cable inlets M20 x 1.5 for ISO 20 cable gland.
 LS75M with 3 cable inlets for 1/2" NPT cable gland.

Ordering Details

Contact blocks						Type	Order code	Unit weight kg
B11	D11	C11	L02	L20	B02			Packing
								1 piece

Adjustable ø50 rubber roller lever

1						LS72M52B11	1SBV 01 4352 R1211	0.355
	1					LS72M52D11	1SBV 01 4352 R1411	0.355
		1				LS72M52C11	1SBV 01 4352 R1511	0.355
			1			LS72M52L02	1SBV 01 4352 R1302	0.355
				1		LS72M52L20	1SBV 01 4352 R1320	0.355
					1	LS72M52B02	1SBV 01 4352 R1202	0.355
1						LS73M52B11	1SBV 01 5252 R1211	0.355
	1					LS73M52D11	1SBV 01 5252 R1411	0.355
		1				LS73M52C11	1SBV 01 5252 R1511	0.355
			1			LS73M52L02	1SBV 01 5252 R1302	0.355
				1		LS73M52L20	1SBV 01 5252 R1320	0.355
					1	LS73M52B02	1SBV 01 5252 R1202	0.355
1						LS75M52B11	1SBV 01 5152 R1211	0.355
	1					LS75M52D11	1SBV 01 5152 R1411	0.355
		1				LS75M52C11	1SBV 01 5152 R1511	0.355
			1			LS75M52L02	1SBV 01 5152 R1302	0.355
				1		LS75M52L20	1SBV 01 5152 R1320	0.355
					1	LS75M52B02	1SBV 01 5152 R1202	0.355

Adjustable ø18 steel roller lever (zinc-plated)

1						LS72M53B11	1SBV 01 4353 R1211	0.340
	1					LS72M53D11	1SBV 01 4353 R1411	0.340
		1				LS72M53C11	1SBV 01 4353 R1511	0.340
			1			LS72M53L02	1SBV 01 4353 R1302	0.340
				1		LS72M53L20	1SBV 01 4353 R1320	0.340
					1	LS72M53B02	1SBV 01 4353 R1202	0.340
1						LS73M53B11	1SBV 01 5253 R1211	0.340
	1					LS73M53D11	1SBV 01 5253 R1411	0.340
		1				LS73M53C11	1SBV 01 5253 R1511	0.340
			1			LS73M53L02	1SBV 01 5253 R1302	0.340
				1		LS73M53L20	1SBV 01 5253 R1320	0.340
					1	LS73M53B02	1SBV 01 5253 R1202	0.340
1						LS75M53B11	1SBV 01 5153 R1211	0.340
	1					LS75M53D11	1SBV 01 5153 R1411	0.340
		1				LS75M53C11	1SBV 01 5153 R1511	0.340
			1			LS75M53L02	1SBV 01 5153 R1302	0.340
				1		LS75M53L20	1SBV 01 5153 R1320	0.340
					1	LS75M53B02	1SBV 01 5153 R1202	0.340

Flexible lever with insulated end

1						LS72M61B11	1SBV 01 4361 R1211	0.375
	1					LS72M61D11	1SBV 01 4361 R1411	0.375
		1				LS72M61C11	1SBV 01 4361 R1511	0.375
			1			LS72M61L02	1SBV 01 4361 R1302	0.375
				1		LS72M61L20	1SBV 01 4361 R1320	0.375
					1	LS72M61B02	1SBV 01 4361 R1202	0.375
1						LS73M61B11	1SBV 01 5261 R1211	0.375
	1					LS73M61D11	1SBV 01 5261 R1411	0.375
		1				LS73M61C11	1SBV 01 5261 R1511	0.375
			1			LS73M61L02	1SBV 01 5261 R1302	0.375
				1		LS73M61L20	1SBV 01 5261 R1320	0.375
					1	LS73M61B02	1SBV 01 5261 R1202	0.375
1						LS75M61B11	1SBV 01 5161 R1211	0.375
	1					LS75M61D11	1SBV 01 5161 R1411	0.375
		1				LS75M61C11	1SBV 01 5161 R1511	0.375
			1			LS75M61L02	1SBV 01 5161 R1302	0.375
				1		LS75M61L20	1SBV 01 5161 R1320	0.375
					1	LS75M61B02	1SBV 01 5161 R1202	0.375

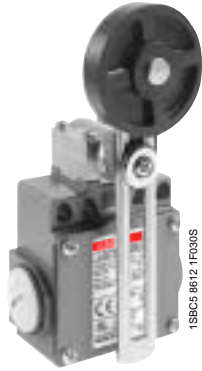

LS72M52B11

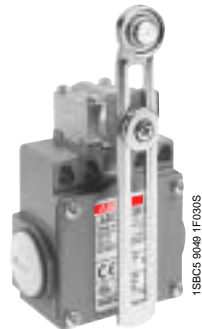

LS72M53B11

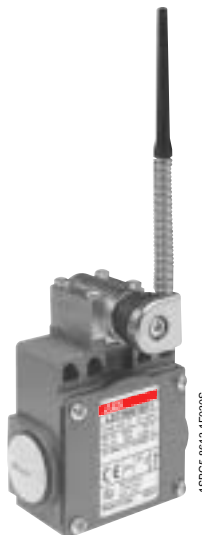













LS72M61B11

LS72M..., LS73M... and LS75M... Limit Switches

Metal Casing IP66 - 60 mm Width

LS72M with 3 cable inlets M16 x 1.5 for ISO 16 cable gland.
 LS73M with 3 cable inlets M20 x 1.5 for ISO 20 cable gland.
 LS75M with 3 cable inlets for 1/2" NPT cable gland.

Ordering Details

Contact blocks	Type	Order code	Unit weight kg Packing
 B11			1 piece
 D11			
 C11			
 L02			
 L20			
 B02			

Coil spring lever

1				LS72M62B11	1SBV 01 4362 R1211	0.380
	1			LS72M62D11	1SBV 01 4362 R1411	0.380
		1		LS72M62C11	1SBV 01 4362 R1511	0.380
			1	LS72M62L02	1SBV 01 4362 R1302	0.380
				LS72M62L20	1SBV 01 4362 R1320	0.380
				LS72M62B02	1SBV 01 4362 R1202	0.380
1				LS73M62B11	1SBV 01 5262 R1211	0.380
	1			LS73M62D11	1SBV 01 5262 R1411	0.380
		1		LS73M62C11	1SBV 01 5262 R1511	0.380
			1	LS73M62L02	1SBV 01 5262 R1302	0.380
				LS73M62L20	1SBV 01 5262 R1320	0.380
				LS73M62B02	1SBV 01 5262 R1202	0.380
1				LS75M62B11	1SBV 01 5162 R1211	0.380
	1			LS75M62D11	1SBV 01 5162 R1411	0.380
		1		LS75M62C11	1SBV 01 5162 R1511	0.380
			1	LS75M62L02	1SBV 01 5162 R1302	0.380
				LS75M62L20	1SBV 01 5162 R1320	0.380
				LS75M62B02	1SBV 01 5162 R1202	0.380

Adjustable ø3 stainless steel rod lever

1				LS72M71B11	1SBV 01 4371 R1211	0.380
	1			LS72M71D11	1SBV 01 4371 R1411	0.380
		1		LS72M71C11	1SBV 01 4371 R1511	0.380
			1	LS72M71L02	1SBV 01 4371 R1302	0.380
				LS72M71L20	1SBV 01 4371 R1320	0.380
				LS72M71B02	1SBV 01 4371 R1202	0.380
1				LS73M71B11	1SBV 01 5271 R1211	0.380
	1			LS73M71D11	1SBV 01 5271 R1411	0.380
		1		LS73M71C11	1SBV 01 5271 R1511	0.380
			1	LS73M71L02	1SBV 01 5271 R1302	0.380
				LS73M71L20	1SBV 01 5271 R1320	0.380
				LS73M71B02	1SBV 01 5271 R1202	0.380
1				LS75M71B11	1SBV 01 5171 R1211	0.380
	1			LS75M71D11	1SBV 01 5171 R1411	0.380
		1		LS75M71C11	1SBV 01 5171 R1511	0.380
			1	LS75M71L02	1SBV 01 5171 R1302	0.380
				LS75M71L20	1SBV 01 5171 R1320	0.380
				LS75M71B02	1SBV 01 5171 R1202	0.380

Adjustable ø3 fibre-glass rod lever

1				LS72M72B11	1SBV 01 4372 R1211	0.370
	1			LS72M72D11	1SBV 01 4372 R1411	0.370
		1		LS72M72C11	1SBV 01 4372 R1511	0.370
			1	LS72M72L02	1SBV 01 4372 R1302	0.370
				LS72M72L20	1SBV 01 4372 R1320	0.370
				LS72M72B02	1SBV 01 4372 R1202	0.370
1				LS73M72B11	1SBV 01 5272 R1211	0.370
	1			LS73M72D11	1SBV 01 5272 R1411	0.370
		1		LS73M72C11	1SBV 01 5272 R1511	0.370
			1	LS73M72L02	1SBV 01 5272 R1302	0.370
				LS73M72L20	1SBV 01 5272 R1320	0.370
				LS73M72B02	1SBV 01 5272 R1202	0.370
1				LS75M72B11	1SBV 01 5172 R1211	0.370
	1			LS75M72D11	1SBV 01 5172 R1411	0.370
		1		LS75M72C11	1SBV 01 5172 R1511	0.370
			1	LS75M72L02	1SBV 01 5172 R1302	0.370
				LS75M72L20	1SBV 01 5172 R1320	0.370
				LS75M72B02	1SBV 01 5172 R1202	0.370

>> Technical Data, Dimensions page 26

>> Accessories page 76

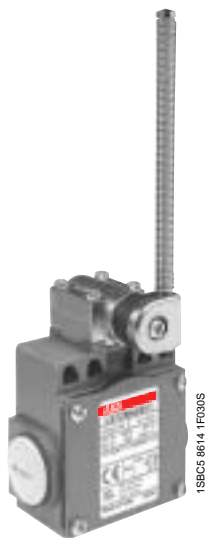

LS72M62B11

1SBVCS 8614 1FO30S

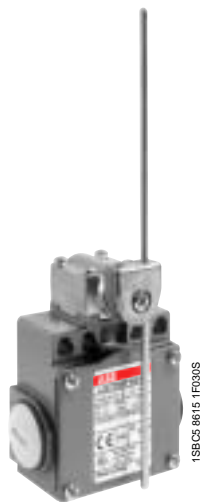

LS72M71B11

1SBVCS 8615 1FO30S



LS72M72B11

1SBVCS 9060 1FO30S

LS72M..., LS73M... and LS75M... Limit Switches

Metal Casing IP66 - 60 mm Width

LS72M with 3 cable inlets M16 x 1.5 for ISO 16 cable gland.
 LS73M with 3 cable inlets M20 x 1.5 for ISO 20 cable gland.
 LS75M with 3 cable inlets for 1/2" NPT cable gland.

Ordering Details

Contact blocks						Type	Order code	Unit weight kg
B11	D11	C11	L02	L20	B02			Packing 1 piece

Adjustable ø6 polyamide rod lever

1						LS72M73B11	1SBV 01 4373 R1211	0.390
	1					LS72M73D11	1SBV 01 4373 R1411	0.390
		1				LS72M73C11	1SBV 01 4373 R1511	0.390
			1			LS72M73L02	1SBV 01 4373 R1302	0.390
				1		LS72M73L20	1SBV 01 4373 R1320	0.390
					1	LS72M73B02	1SBV 01 4373 R1202	0.390
1						LS73M73B11	1SBV 01 5273 R1211	0.390
	1					LS73M73D11	1SBV 01 5273 R1411	0.390
		1				LS73M73C11	1SBV 01 5273 R1511	0.390
			1			LS73M73L02	1SBV 01 5273 R1302	0.390
				1		LS73M73L20	1SBV 01 5273 R1320	0.390
					1	LS73M73B02	1SBV 01 5273 R1202	0.390
1						LS75M73B11	1SBV 01 5173 R1211	0.390
	1					LS75M73D11	1SBV 01 5173 R1411	0.390
		1				LS75M73C11	1SBV 01 5173 R1511	0.390
			1			LS75M73L02	1SBV 01 5173 R1302	0.390
				1		LS75M73L20	1SBV 01 5173 R1320	0.390
					1	LS75M73B02	1SBV 01 5173 R1202	0.390

Adjustable ø6 fibre-glass rod lever

1						LS72M74B11	1SBV 01 4374 R1211	0.390
	1					LS72M74D11	1SBV 01 4374 R1411	0.390
		1				LS72M74C11	1SBV 01 4374 R1511	0.390
			1			LS72M74L02	1SBV 01 4374 R1302	0.390
				1		LS72M74L20	1SBV 01 4374 R1320	0.390
					1	LS72M74B02	1SBV 01 4374 R1202	0.390
1						LS73M74B11	1SBV 01 5274 R1211	0.390
	1					LS73M74D11	1SBV 01 5274 R1411	0.390
		1				LS73M74C11	1SBV 01 5274 R1511	0.390
			1			LS73M74L02	1SBV 01 5274 R1302	0.390
				1		LS73M74L20	1SBV 01 5274 R1320	0.390
					1	LS73M74B02	1SBV 01 5274 R1202	0.390
1						LS75M74B11	1SBV 01 5174 R1211	0.390
	1					LS75M74D11	1SBV 01 5174 R1411	0.390
		1				LS75M74C11	1SBV 01 5174 R1511	0.390
			1			LS75M74L02	1SBV 01 5174 R1302	0.390
				1		LS75M74L20	1SBV 01 5174 R1320	0.390
					1	LS75M74B02	1SBV 01 5174 R1202	0.390

Adjustable ø3 square steel rod lever (zinc-plated)

1						LS72M78B11	1SBV 01 4378 R1211	0.375
	1					LS72M78D11	1SBV 01 4378 R1411	0.375
		1				LS72M78C11	1SBV 01 4378 R1511	0.375
			1			LS72M78L02	1SBV 01 4378 R1302	0.375
				1		LS72M78L20	1SBV 01 4378 R1320	0.375
					1	LS72M78B02	1SBV 01 4378 R1202	0.375
1						LS73M78B11	1SBV 01 5278 R1211	0.375
	1					LS73M78D11	1SBV 01 5278 R1411	0.375
		1				LS73M78C11	1SBV 01 5278 R1511	0.375
			1			LS73M78L02	1SBV 01 5278 R1302	0.375
				1		LS73M78L20	1SBV 01 5278 R1320	0.375
					1	LS73M78B02	1SBV 01 5278 R1202	0.375
1						LS75M78B11	1SBV 01 5178 R1211	0.375
	1					LS75M78D11	1SBV 01 5178 R1411	0.375
		1				LS75M78C11	1SBV 01 5178 R1511	0.375
			1			LS75M78L02	1SBV 01 5178 R1302	0.375
				1		LS75M78L20	1SBV 01 5178 R1320	0.375
					1	LS75M78B02	1SBV 01 5178 R1202	0.375

>> Technical Data, Dimensions page 27

>> Accessories page 76



LS72M..., LS73M... and LS75M... Limit Switches

Metal Casing IP66 - 60 mm Width

LS72M with 3 cable inlets M16 x 1.5 for ISO 16 cable gland.
 LS73M with 3 cable inlets M20 x 1.5 for ISO 20 cable gland.
 LS75M with 3 cable inlets for 1/2" NPT cable gland.

Ordering Details

Contact blocks						Type	Order code	Unit weight kg Packing
B11	D11	C11	L02	L20	B02			1 piece

Spring rod

1						LS72M91B11	1SBV 01 4391 R1211	0.315
	1					LS72M91D11	1SBV 01 4391 R1411	0.315
		1				LS72M91C11	1SBV 01 4391 R1511	0.315
			1			LS72M91L02	1SBV 01 4391 R1302	0.315
				1		LS72M91L20	1SBV 01 4391 R1320	0.315
					1	LS72M91B02	1SBV 01 4391 R1202	0.315
1						LS73M91B11	1SBV 01 5291 R1211	0.315
	1					LS73M91D11	1SBV 01 5291 R1411	0.315
		1				LS73M91C11	1SBV 01 5291 R1511	0.315
			1			LS73M91L02	1SBV 01 5291 R1302	0.315
				1		LS73M91L20	1SBV 01 5291 R1320	0.315
					1	LS73M91B02	1SBV 01 5291 R1202	0.315
1						LS75M91B11	1SBV 01 5191 R1211	0.315
	1					LS75M91D11	1SBV 01 5191 R1411	0.315
		1				LS75M91C11	1SBV 01 5191 R1511	0.315
			1			LS75M91L02	1SBV 01 5191 R1302	0.315
				1		LS75M91L20	1SBV 01 5191 R1320	0.315
					1	LS75M91B02	1SBV 01 5191 R1202	0.315

Flexible rod with insulated end

1						LS72M92B11	1SBV 01 4392 R1211	0.320
	1					LS72M92D11	1SBV 01 4392 R1411	0.320
		1				LS72M92C11	1SBV 01 4392 R1511	0.320
			1			LS72M92L02	1SBV 01 4392 R1302	0.320
				1		LS72M92L20	1SBV 01 4392 R1320	0.320
					1	LS72M92B02	1SBV 01 4392 R1202	0.320
1						LS73M92B11	1SBV 01 5292 R1211	0.320
	1					LS73M92D11	1SBV 01 5292 R1411	0.320
		1				LS73M92C11	1SBV 01 5292 R1511	0.320
			1			LS73M92L02	1SBV 01 5292 R1302	0.320
				1		LS73M92L20	1SBV 01 5292 R1320	0.320
					1	LS73M92B02	1SBV 01 5292 R1202	0.320
1						LS75M92B11	1SBV 01 5192 R1211	0.320
	1					LS75M92D11	1SBV 01 5192 R1411	0.320
		1				LS75M92C11	1SBV 01 5192 R1511	0.320
			1			LS75M92L02	1SBV 01 5192 R1302	0.320
				1		LS75M92L20	1SBV 01 5192 R1320	0.320
					1	LS75M92B02	1SBV 01 5192 R1202	0.320

Pull action with ring

1						LS72M98B11-A	1SBV 01 4398 R1211	0.350
	1					LS72M98D11-A	1SBV 01 4398 R1411	0.350
			1			LS72M98L02-A	1SBV 01 4398 R1302	0.350
				1		LS72M98L20-A	1SBV 01 4398 R1320	0.350
1						LS73M98B11-A	1SBV 01 5298 R1211	0.350
	1					LS73M98D11-A	1SBV 01 5298 R1411	0.350
			1			LS73M98L02-A	1SBV 01 5298 R1302	0.350
				1		LS73M98L20-A	1SBV 01 5298 R1320	0.350
1						LS75M98B11-A	1SBV 01 5198 R1211	0.350
	1					LS75M98D11-A	1SBV 01 5198 R1411	0.350
			1			LS75M98L02-A	1SBV 01 5198 R1302	0.350
				1		LS75M98L20-A	1SBV 01 5198 R1320	0.350



LS72M91B11



LS72M92B11

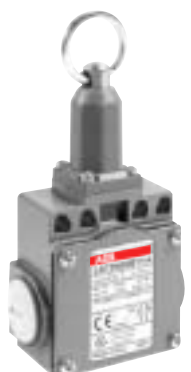

LS72M98B11-A

>> Technical Data, Dimensions page 27







>> Accessories page 76

LS72P..., LS73P... and LS75P... Limit Switches

Double Insulation - Plastic Casing IP65 - 60 mm Width

LS72P with 2 cable inlets M16 x 1.5 for ISO 16 cable gland.
 LS73P with 2 cable inlets M20 x 1.5 for ISO 20 cable gland.
 LS75P with 1 cable inlet by 1/2" NPT plastic adaptor + 1 cable inlet Pg11 for additional 1/2" NPT plastic adaptor (on request).

Ordering Details

Contact blocks						Type	Order code	Unit weight kg Packing 1 piece
								
B11	D11	C11	L02	L20	B02			

Plastic plain plunger (polyacetal)

1						LS72P10B11	1SBV 01 1010 R1211	0.095
	1					LS72P10D11	1SBV 01 1010 R1411	0.095
		1				LS72P10C11	1SBV 01 1010 R1511	0.095
			1			LS72P10L02	1SBV 01 1010 R1302	0.095
				1		LS72P10L20	1SBV 01 1010 R1320	0.095
					1	LS72P10B02	1SBV 01 1010 R1202	0.095
1						LS73P10B11	1SBV 01 2810 R1211	0.095
	1					LS73P10D11	1SBV 01 2810 R1411	0.095
		1				LS73P10C11	1SBV 01 2810 R1511	0.095
			1			LS73P10L02	1SBV 01 2810 R1302	0.095
				1		LS73P10L20	1SBV 01 2810 R1320	0.095
					1	LS73P10B02	1SBV 01 2810 R1202	0.095
1						LS75P10B11	1SBV 01 2710 R1211	0.102
	1					LS75P10D11	1SBV 01 2710 R1411	0.102
		1				LS75P10C11	1SBV 01 2710 R1511	0.102
			1			LS75P10L02	1SBV 01 2710 R1302	0.102
				1		LS75P10L20	1SBV 01 2710 R1320	0.102
					1	LS75P10B02	1SBV 01 2710 R1202	0.102

Steel plain plunger (zinc-plated)

1						LS72P11B11	1SBV 01 1011 R1211	0.100
	1					LS72P11D11	1SBV 01 1011 R1411	0.100
		1				LS72P11C11	1SBV 01 1011 R1511	0.100
			1			LS72P11L02	1SBV 01 1011 R1302	0.100
				1		LS72P11L20	1SBV 01 1011 R1320	0.100
					1	LS72P11B02	1SBV 01 1011 R1202	0.100
1						LS73P11B11	1SBV 01 2811 R1211	0.100
	1					LS73P11D11	1SBV 01 2811 R1411	0.100
		1				LS73P11C11	1SBV 01 2811 R1511	0.100
			1			LS73P11L02	1SBV 01 2811 R1302	0.100
				1		LS73P11L20	1SBV 01 2811 R1320	0.100
					1	LS73P11B02	1SBV 01 2811 R1202	0.100
1						LS75P11B11	1SBV 01 2711 R1211	0.107
	1					LS75P11D11	1SBV 01 2711 R1411	0.107
		1				LS75P11C11	1SBV 01 2711 R1511	0.107
			1			LS75P11L02	1SBV 01 2711 R1302	0.107
				1		LS75P11L20	1SBV 01 2711 R1320	0.107
					1	LS75P11B02	1SBV 01 2711 R1202	0.107

ø11 steel roller plunger (zinc-plated)

1						LS72P12B11	1SBV 01 1012 R1211	0.105
	1					LS72P12D11	1SBV 01 1012 R1411	0.105
		1				LS72P12C11	1SBV 01 1012 R1511	0.105
			1			LS72P12L02	1SBV 01 1012 R1302	0.105
				1		LS72P12L20	1SBV 01 1012 R1320	0.105
					1	LS72P12B02	1SBV 01 1012 R1202	0.105
1						LS73P12B11	1SBV 01 2812 R1211	0.105
	1					LS73P12D11	1SBV 01 2812 R1411	0.105
		1				LS73P12C11	1SBV 01 2812 R1511	0.105
			1			LS73P12L02	1SBV 01 2812 R1302	0.105
				1		LS73P12L20	1SBV 01 2812 R1320	0.105
					1	LS73P12B02	1SBV 01 2812 R1202	0.105
1						LS75P12B11	1SBV 01 2712 R1211	0.112
	1					LS75P12D11	1SBV 01 2712 R1411	0.112
		1				LS75P12C11	1SBV 01 2712 R1511	0.112
			1			LS75P12L02	1SBV 01 2712 R1302	0.112
				1		LS75P12L20	1SBV 01 2712 R1320	0.112
					1	LS75P12B02	1SBV 01 2712 R1202	0.112



LS72P10B11

1SBC5 8686 1F0305



LS72P11B11

1SBC5 8686 1F0305



LS72P12B11







1SBC5 9002 1F0305

LS72P..., LS73P... and LS75P... Limit Switches

Double Insulation - Plastic Casing IP65 - 60 mm Width

LS72P with 2 cable inlets M16 x 1.5 for ISO 16 cable gland.
 LS73P with 2 cable inlets M20 x 1.5 for ISO 20 cable gland.
 LS75P with 1 cable inlet by 1/2" NPT plastic adaptor + 1 cable inlet Pg11 for additional 1/2" NPT plastic adaptor (on request).

Ordering Details

Contact blocks						Type	Order code	Unit weight kg Packing 1 piece
								
B11	D11	C11	L02	L20	B02			

ø11 plastic (polyacetal) roller plunger

1						LS72P13B11	1SBV 01 1013 R1211	0.100
	1					LS72P13D11	1SBV 01 1013 R1411	0.100
		1				LS72P13C11	1SBV 01 1013 R1511	0.100
			1			LS72P13L02	1SBV 01 1013 R1302	0.100
				1		LS72P13L20	1SBV 01 1013 R1320	0.100
					1	LS72P13B02	1SBV 01 1013 R1202	0.100
1						LS73P13B11	1SBV 01 2813 R1211	0.100
	1					LS73P13D11	1SBV 01 2813 R1411	0.100
		1				LS73P13C11	1SBV 01 2813 R1511	0.100
			1			LS73P13L02	1SBV 01 2813 R1302	0.100
				1		LS73P13L20	1SBV 01 2813 R1320	0.100
					1	LS73P13B02	1SBV 01 2813 R1202	0.100
1						LS75P13B11	1SBV 01 2713 R1211	0.107
	1					LS75P13D11	1SBV 01 2713 R1411	0.107
		1				LS75P13C11	1SBV 01 2713 R1511	0.107
			1			LS75P13L02	1SBV 01 2713 R1302	0.107
				1		LS75P13L20	1SBV 01 2713 R1320	0.107
					1	LS75P13B02	1SBV 01 2713 R1202	0.107

ø12.5 plastic (polyacetal) roller lever on plastic (polyacetal) plunger

1						LS72P30B11	1SBV 01 1030 R1211	0.100
	1					LS72P30D11	1SBV 01 1030 R1411	0.100
		1				LS72P30C11	1SBV 01 1030 R1511	0.100
			1			LS72P30L02	1SBV 01 1030 R1302	0.100
				1		LS72P30L20	1SBV 01 1030 R1320	0.100
					1	LS72P30B02	1SBV 01 1030 R1202	0.100
1						LS73P30B11	1SBV 01 2830 R1211	0.100
	1					LS73P30D11	1SBV 01 2830 R1411	0.100
		1				LS73P30C11	1SBV 01 2830 R1511	0.100
			1			LS73P30L02	1SBV 01 2830 R1302	0.100
				1		LS73P30L20	1SBV 01 2830 R1320	0.100
					1	LS73P30B02	1SBV 01 2830 R1202	0.100
1						LS75P30B11	1SBV 01 2730 R1211	0.107
	1					LS75P30D11	1SBV 01 2730 R1411	0.107
		1				LS75P30C11	1SBV 01 2730 R1511	0.107
			1			LS75P30L02	1SBV 01 2730 R1302	0.107
				1		LS75P30L20	1SBV 01 2730 R1320	0.107
					1	LS75P30B02	1SBV 01 2730 R1202	0.107

ø12.5 plastic (polyacetal) roller lever on steel plunger (zinc-plated)

1						LS72P31B11	1SBV 01 1031 R1211	0.105
	1					LS72P31D11	1SBV 01 1031 R1411	0.105
		1				LS72P31C11	1SBV 01 1031 R1511	0.105
			1			LS72P31L02	1SBV 01 1031 R1302	0.105
				1		LS72P31L20	1SBV 01 1031 R1320	0.105
					1	LS72P31B02	1SBV 01 1031 R1202	0.105
1						LS73P31B11	1SBV 01 2831 R1211	0.105
	1					LS73P31D11	1SBV 01 2831 R1411	0.105
		1				LS73P31C11	1SBV 01 2831 R1511	0.105
			1			LS73P31L02	1SBV 01 2831 R1302	0.105
				1		LS73P31L20	1SBV 01 2831 R1320	0.105
					1	LS73P31B02	1SBV 01 2831 R1202	0.105
1						LS75P31B11	1SBV 01 2731 R1211	0.112
	1					LS75P31D11	1SBV 01 2731 R1411	0.112
		1				LS75P31C11	1SBV 01 2731 R1511	0.112
			1			LS75P31L02	1SBV 01 2731 R1302	0.112
				1		LS75P31L20	1SBV 01 2731 R1320	0.112
					1	LS75P31B02	1SBV 01 2731 R1202	0.112

>> Technical Data, Dimensions pages 36, 37

>> Accessories page 76



LS72P13B11

1SBG05 8697 1F030S



LS72P30B11

1SBG05 8698 1F030S



LS72P31B11

1SBG05 8699 1F030S

LS72P..., LS73P... and LS75P... Limit Switches

Double Insulation - Plastic Casing IP65 - 60 mm Width

LS72P with 2 cable inlets M16 x 1.5 for ISO 16 cable gland.
 LS73P with 2 cable inlets M20 x 1.5 for ISO 20 cable gland.
 LS75P with 1 cable inlet by 1/2" NPT plastic adaptor + 1 cable inlet Pg11 for additional 1/2" NPT plastic adaptor (on request).

Ordering Details

Contact blocks						Type	Order code	Unit weight kg
B11	D11	C11	L02	L20	B02			Packing 1 piece

ø12.5 plastic (polyacetal) roller lever on steel plunger (zinc-plated) with dust production cup

1						LS72P35B11	1SBV 01 1035 R1211	0.105
	1					LS72P35D11	1SBV 01 1035 R1411	0.105
		1				LS72P35C11	1SBV 01 1035 R1511	0.105
			1			LS72P35L02	1SBV 01 1035 R1302	0.105
				1		LS72P35L20	1SBV 01 1035 R1320	0.105
					1	LS72P35B02	1SBV 01 1035 R1202	0.105
1						LS73P35B11	1SBV 01 2835 R1211	0.105
	1					LS73P35D11	1SBV 01 2835 R1411	0.105
		1				LS73P35C11	1SBV 01 2835 R1511	0.105
			1			LS73P35L02	1SBV 01 2835 R1302	0.105
				1		LS73P35L20	1SBV 01 2835 R1320	0.105
					1	LS73P35B02	1SBV 01 2835 R1202	0.105
1						LS75P35B11	1SBV 01 2735 R1211	0.112
	1					LS75P35D11	1SBV 01 2735 R1411	0.112
		1				LS75P35C11	1SBV 01 2735 R1511	0.112
			1			LS75P35L02	1SBV 01 2735 R1302	0.112
				1		LS75P35L20	1SBV 01 2735 R1320	0.112
					1	LS75P35B02	1SBV 01 2735 R1202	0.112

Adjustable ø22 plastic (polyacetal) roller lever on steel plunger (zinc-plated)

1						LS72P38B11	1SBV 01 1038 R1211	0.110
	1					LS72P38D11	1SBV 01 1038 R1411	0.110
		1				LS72P38C11	1SBV 01 1038 R1511	0.110
			1			LS72P38L02	1SBV 01 1038 R1302	0.110
				1		LS72P38L20	1SBV 01 1038 R1320	0.110
					1	LS72P38B02	1SBV 01 1038 R1202	0.110
1						LS73P38B11	1SBV 01 2838 R1211	0.110
	1					LS73P38D11	1SBV 01 2838 R1411	0.110
		1				LS73P38C11	1SBV 01 2838 R1511	0.110
			1			LS73P38L02	1SBV 01 2838 R1302	0.110
				1		LS73P38L20	1SBV 01 2838 R1320	0.110
					1	LS73P38B02	1SBV 01 2838 R1202	0.110
1						LS75P38B11	1SBV 01 2738 R1211	0.117
	1					LS75P38D11	1SBV 01 2738 R1411	0.117
		1				LS75P38C11	1SBV 01 2738 R1511	0.117
			1			LS75P38L02	1SBV 01 2738 R1302	0.117
				1		LS75P38L20	1SBV 01 2738 R1320	0.117
					1	LS75P38B02	1SBV 01 2738 R1202	0.117

ø18 plastic (polyacetal) roller lever

1						LS72P41B11	1SBV 01 1041 R1211	0.125
	1					LS72P41D11	1SBV 01 1041 R1411	0.125
		1				LS72P41C11	1SBV 01 1041 R1511	0.125
			1			LS72P41L02	1SBV 01 1041 R1302	0.125
				1		LS72P41L20	1SBV 01 1041 R1320	0.125
					1	LS72P41B02	1SBV 01 1041 R1202	0.125
1						LS73P41B11	1SBV 01 2841 R1211	0.125
	1					LS73P41D11	1SBV 01 2841 R1411	0.125
		1				LS73P41C11	1SBV 01 2841 R1511	0.125
			1			LS73P41L02	1SBV 01 2841 R1302	0.125
				1		LS73P41L20	1SBV 01 2841 R1320	0.125
					1	LS73P41B02	1SBV 01 2841 R1202	0.125
1						LS75P41B11	1SBV 01 2741 R1211	0.132
	1					LS75P41D11	1SBV 01 2741 R1411	0.132
		1				LS75P41C11	1SBV 01 2741 R1511	0.132
			1			LS75P41L02	1SBV 01 2741 R1302	0.132
				1		LS75P41L20	1SBV 01 2741 R1320	0.132
					1	LS75P41B02	1SBV 01 2741 R1202	0.132

>> Technical Data, Dimensions page 37

>> Accessories page 76



LS72P35B11



LS72P38B11



LS72P41B11

LS72P..., LS73P... and LS75P... Limit Switches

Double Insulation - Plastic Casing IP65 - 60 mm Width

LS72P with 2 cable inlets M16 x 1.5 for ISO 16 cable gland.
 LS73P with 2 cable inlets M20 x 1.5 for ISO 20 cable gland.
 LS75P with 1 cable inlet by 1/2" NPT plastic adaptor + 1 cable inlet Pg11 for additional 1/2" NPT plastic adaptor (on request).

Ordering Details

Contact blocks						Type	Order code	Unit weight kg Packing 1 piece
B11	D11	C11	L02	L20	B02			

ø50 rubber roller lever

1						LS72P42B11	1SBV 01 1042 R1211	0.145
	1					LS72P42D11	1SBV 01 1042 R1411	0.145
		1				LS72P42C11	1SBV 01 1042 R1511	0.145
			1			LS72P42L02	1SBV 01 1042 R1302	0.145
				1		LS72P42L20	1SBV 01 1042 R1320	0.145
					1	LS72P42B02	1SBV 01 1042 R1202	0.145
1						LS73P42B11	1SBV 01 2842 R1211	0.145
	1					LS73P42D11	1SBV 01 2842 R1411	0.145
		1				LS73P42C11	1SBV 01 2842 R1511	0.145
			1			LS73P42L02	1SBV 01 2842 R1302	0.145
				1		LS73P42L20	1SBV 01 2842 R1320	0.145
					1	LS73P42B02	1SBV 01 2842 R1202	0.145
1						LS75P42B11	1SBV 01 2742 R1211	0.152
	1					LS75P42D11	1SBV 01 2742 R1411	0.152
		1				LS75P42C11	1SBV 01 2742 R1511	0.152
			1			LS75P42L02	1SBV 01 2742 R1302	0.152
				1		LS75P42L20	1SBV 01 2742 R1320	0.152
					1	LS75P42B02	1SBV 01 2742 R1202	0.152

ø18 steel roller lever (zinc-plated)

1						LS72P43B11	1SBV 01 1043 R1211	0.130
	1					LS72P43D11	1SBV 01 1043 R1411	0.130
		1				LS72P43C11	1SBV 01 1043 R1511	0.130
			1			LS72P43L02	1SBV 01 1043 R1302	0.130
				1		LS72P43L20	1SBV 01 1043 R1320	0.130
					1	LS72P43B02	1SBV 01 1043 R1202	0.130
1						LS73P43B11	1SBV 01 2843 R1211	0.130
	1					LS73P43D11	1SBV 01 2843 R1411	0.130
		1				LS73P43C11	1SBV 01 2843 R1511	0.130
			1			LS73P43L02	1SBV 01 2843 R1302	0.130
				1		LS73P43L20	1SBV 01 2843 R1320	0.130
					1	LS73P43B02	1SBV 01 2843 R1202	0.130
1						LS75P43B11	1SBV 01 2743 R1211	0.137
	1					LS75P43D11	1SBV 01 2743 R1411	0.137
		1				LS75P43C11	1SBV 01 2743 R1511	0.137
			1			LS75P43L02	1SBV 01 2743 R1302	0.137
				1		LS75P43L20	1SBV 01 2743 R1320	0.137
					1	LS75P43B02	1SBV 01 2743 R1202	0.137

ø18 plastic (polyacetal) roller with bent lever

1						LS72P45B11	1SBV 01 1045 R1211	0.125
	1					LS72P45D11	1SBV 01 1045 R1411	0.125
		1				LS72P45C11	1SBV 01 1045 R1511	0.125
			1			LS72P45L02	1SBV 01 1045 R1302	0.125
				1		LS72P45L20	1SBV 01 1045 R1320	0.125
					1	LS72P45B02	1SBV 01 1045 R1202	0.125
1						LS73P45B11	1SBV 01 2845 R1211	0.125
	1					LS73P45D11	1SBV 01 2845 R1411	0.125
		1				LS73P45C11	1SBV 01 2845 R1511	0.125
			1			LS73P45L02	1SBV 01 2845 R1302	0.125
				1		LS73P45L20	1SBV 01 2845 R1320	0.125
					1	LS73P45B02	1SBV 01 2845 R1202	0.125
1						LS75P45B11	1SBV 01 2745 R1211	0.132
	1					LS75P45D11	1SBV 01 2745 R1411	0.132
		1				LS75P45C11	1SBV 01 2745 R1511	0.132
			1			LS75P45L02	1SBV 01 2745 R1302	0.132
				1		LS75P45L20	1SBV 01 2745 R1320	0.132
					1	LS75P45B02	1SBV 01 2745 R1202	0.132

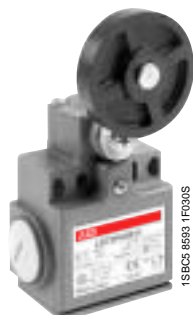

LS72P42B11



LS72P43B11





LS72P45B11

LS72P..., LS73P... and LS75P... Limit Switches

Double Insulation - Plastic Casing IP65 - 60 mm Width

LS72P with 2 cable inlets M16 x 1.5 for ISO 16 cable gland.
 LS73P with 2 cable inlets M20 x 1.5 for ISO 20 cable gland.
 LS75P with 1 cable inlet by 1/2" NPT plastic adaptor + 1 cable inlet Pg11 for additional 1/2" NPT plastic adaptor (on request).

Ordering Details

Contact blocks						Type	Order code	Unit weight kg Packing 1 piece
								
B11	D11	C11	L02	L20	B02			

ø18 steel roller (zinc-plated) with bent lever

1						LS72P46B11	1SBV 01 1046 R1211	0.130
	1					LS72P46D11	1SBV 01 1046 R1411	0.130
		1				LS72P46C11	1SBV 01 1046 R1511	0.130
			1			LS72P46L02	1SBV 01 1046 R1302	0.130
				1		LS72P46L20	1SBV 01 1046 R1320	0.130
					1	LS72P46B02	1SBV 01 1046 R1202	0.130
1						LS73P46B11	1SBV 01 2846 R1211	0.130
	1					LS73P46D11	1SBV 01 2846 R1411	0.130
		1				LS73P46C11	1SBV 01 2846 R1511	0.130
			1			LS73P46L02	1SBV 01 2846 R1302	0.130
				1		LS73P46L20	1SBV 01 2846 R1320	0.130
					1	LS73P46B02	1SBV 01 2846 R1202	0.130
1						LS75P46B11	1SBV 01 2746 R1211	0.137
	1					LS75P46D11	1SBV 01 2746 R1411	0.137
		1				LS75P46C11	1SBV 01 2746 R1511	0.137
			1			LS75P46L02	1SBV 01 2746 R1302	0.137
				1		LS75P46L20	1SBV 01 2746 R1320	0.137
					1	LS75P46B02	1SBV 01 2746 R1202	0.137

Adjustable ø18 plastic (polyacetal) roller lever

1						LS72P51B11	1SBV 01 1051 R1211	0.135
	1					LS72P51D11	1SBV 01 1051 R1411	0.135
		1				LS72P51C11	1SBV 01 1051 R1511	0.135
			1			LS72P51L02	1SBV 01 1051 R1302	0.135
				1		LS72P51L20	1SBV 01 1051 R1320	0.135
					1	LS72P51B02	1SBV 01 1051 R1202	0.135
1						LS73P51B11	1SBV 01 2851 R1211	0.135
	1					LS73P51D11	1SBV 01 2851 R1411	0.135
		1				LS73P51C11	1SBV 01 2851 R1511	0.135
			1			LS73P51L02	1SBV 01 2851 R1302	0.135
				1		LS73P51L20	1SBV 01 2851 R1320	0.135
					1	LS73P51B02	1SBV 01 2851 R1202	0.135
1						LS75P51B11	1SBV 01 2751 R1211	0.142
	1					LS75P51D11	1SBV 01 2751 R1411	0.142
		1				LS75P51C11	1SBV 01 2751 R1511	0.142
			1			LS75P51L02	1SBV 01 2751 R1302	0.142
				1		LS75P51L20	1SBV 01 2751 R1320	0.142
					1	LS75P51B02	1SBV 01 2751 R1202	0.142

Adjustable ø50 rubber roller lever

1						LS72P52B11	1SBV 01 1052 R1211	0.155
	1					LS72P52D11	1SBV 01 1052 R1411	0.155
		1				LS72P52C11	1SBV 01 1052 R1511	0.155
			1			LS72P52L02	1SBV 01 1052 R1302	0.155
				1		LS72P52L20	1SBV 01 1052 R1320	0.155
					1	LS72P52B02	1SBV 01 1052 R1202	0.155
1						LS73P52B11	1SBV 01 2852 R1211	0.155
	1					LS73P52D11	1SBV 01 2852 R1411	0.155
		1				LS73P52C11	1SBV 01 2852 R1511	0.155
			1			LS73P52L02	1SBV 01 2852 R1302	0.155
				1		LS73P52L20	1SBV 01 2852 R1320	0.155
					1	LS73P52B02	1SBV 01 2852 R1202	0.155
1						LS75P52B11	1SBV 01 2752 R1211	0.162
	1					LS75P52D11	1SBV 01 2752 R1411	0.162
		1				LS75P52C11	1SBV 01 2752 R1511	0.162
			1			LS75P52L02	1SBV 01 2752 R1302	0.162
				1		LS75P52L20	1SBV 01 2752 R1320	0.162
					1	LS75P52B02	1SBV 01 2752 R1202	0.162

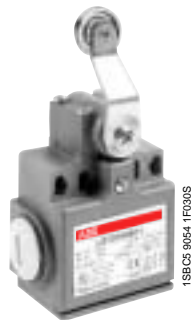

LS72P46B11

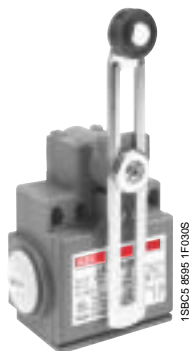

LS72P51B11

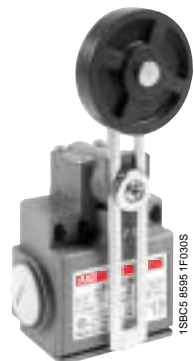

LS72P52B11

LS72P..., LS73P... and LS75P... Limit Switches

Double Insulation - Plastic Casing IP65 - 60 mm Width

LS72P with 2 cable inlets M16 x 1.5 for ISO 16 cable gland.
 LS73P with 2 cable inlets M20 x 1.5 for ISO 20 cable gland.
 LS75P with 1 cable inlet by 1/2" NPT plastic adaptor + 1 cable inlet Pg11 for additional 1/2" NPT plastic adaptor (on request).

Ordering Details

Contact blocks						Type	Order code	Unit weight kg Packing 1 piece
B11	D11	C11	L02	L20	B02			

Adjustable ø18 steel roller (zinc-plated) lever

1						LS72P53B11	1SBV 01 1053 R1211	0.140
	1					LS72P53D11	1SBV 01 1053 R1411	0.140
		1				LS72P53C11	1SBV 01 1053 R1511	0.140
			1			LS72P53L02	1SBV 01 1053 R1302	0.140
				1		LS72P53L20	1SBV 01 1053 R1320	0.140
					1	LS72P53B02	1SBV 01 1053 R1202	0.140
1						LS73P53B11	1SBV 01 2853 R1211	0.140
	1					LS73P53D11	1SBV 01 2853 R1411	0.140
		1				LS73P53C11	1SBV 01 2853 R1511	0.140
			1			LS73P53L02	1SBV 01 2853 R1302	0.140
				1		LS73P53L20	1SBV 01 2853 R1320	0.140
					1	LS73P53B02	1SBV 01 2853 R1202	0.140
1						LS75P53B11	1SBV 01 2753 R1211	0.147
	1					LS75P53D11	1SBV 01 2753 R1411	0.147
		1				LS75P53C11	1SBV 01 2753 R1511	0.147
			1			LS75P53L02	1SBV 01 2753 R1302	0.147
				1		LS75P53L20	1SBV 01 2753 R1320	0.147
					1	LS75P53B02	1SBV 01 2753 R1202	0.147

Adjustable ø3 stainless steel rod lever

1						LS72P71B11	1SBV 01 1071 R1211	0.130
	1					LS72P71D11	1SBV 01 1071 R1411	0.130
		1				LS72P71C11	1SBV 01 1071 R1511	0.130
			1			LS72P71L02	1SBV 01 1071 R1302	0.130
				1		LS72P71L20	1SBV 01 1071 R1320	0.130
					1	LS72P71B02	1SBV 01 1071 R1202	0.130
1						LS73P71B11	1SBV 01 2871 R1211	0.130
	1					LS73P71D11	1SBV 01 2871 R1411	0.130
		1				LS73P71C11	1SBV 01 2871 R1511	0.130
			1			LS73P71L02	1SBV 01 2871 R1302	0.130
				1		LS73P71L20	1SBV 01 2871 R1320	0.130
					1	LS73P71B02	1SBV 01 2871 R1202	0.130
1						LS75P71B11	1SBV 01 2771 R1211	0.137
	1					LS75P71D11	1SBV 01 2771 R1411	0.137
		1				LS75P71C11	1SBV 01 2771 R1511	0.137
			1			LS75P71L02	1SBV 01 2771 R1302	0.137
				1		LS75P71L20	1SBV 01 2771 R1320	0.137
					1	LS75P71B02	1SBV 01 2771 R1202	0.137

Adjustable ø3 fibre-glass rod lever

1						LS72P72B11	1SBV 01 1072 R1211	0.120
	1					LS72P72D11	1SBV 01 1072 R1411	0.120
		1				LS72P72C11	1SBV 01 1072 R1511	0.120
			1			LS72P72L02	1SBV 01 1072 R1302	0.120
				1		LS72P72L20	1SBV 01 1072 R1320	0.120
					1	LS72P72B02	1SBV 01 1072 R1202	0.120
1						LS73P72B11	1SBV 01 2872 R1211	0.120
	1					LS73P72D11	1SBV 01 2872 R1411	0.120
		1				LS73P72C11	1SBV 01 2872 R1511	0.120
			1			LS73P72L02	1SBV 01 2872 R1302	0.120
				1		LS73P72L20	1SBV 01 2872 R1320	0.120
					1	LS73P72B02	1SBV 01 2872 R1202	0.120
1						LS75P72B11	1SBV 01 2772 R1211	0.127
	1					LS75P72D11	1SBV 01 2772 R1411	0.127
		1				LS75P72C11	1SBV 01 2772 R1511	0.127
			1			LS75P72L02	1SBV 01 2772 R1302	0.127
				1		LS75P72L20	1SBV 01 2772 R1320	0.127
					1	LS75P72B02	1SBV 01 2772 R1202	0.127

>> Technical Data, Dimensions page 38

>> Accessories page 76



LS72P53B11

1SBSC5 9065 1F030S



LS72P71B11

1SBSC5 9066 1F030S



LS72P72B11







1SBSC5 9567 1F030S

LS72P..., LS73P... and LS75P... Limit Switches

Double Insulation - Plastic Casing IP65 - 60 mm Width

LS72P with 2 cable inlets M16 x 1.5 for ISO 16 cable gland.
 LS73P with 2 cable inlets M20 x 1.5 for ISO 20 cable gland.
 LS75P with 1 cable inlet by 1/2" NPT plastic adaptor + 1 cable inlet Pg11 for additional 1/2" NPT plastic adaptor (on request).

Ordering Details

Contact blocks						Type	Order code	Unit weight kg
								Packing 1 piece
B11	D11	C11	L02	L20	B02			

Adjustable ø6 polyamide rod lever

1						LS72P73B11	1SBV 01 1073 R1211	0.145
	1					LS72P73D11	1SBV 01 1073 R1411	0.145
		1				LS72P73C11	1SBV 01 1073 R1511	0.145
			1			LS72P73L02	1SBV 01 1073 R1302	0.145
				1		LS72P73L20	1SBV 01 1073 R1320	0.145
					1	LS72P73B02	1SBV 01 1073 R1202	0.145
1						LS73P73B11	1SBV 01 2873 R1211	0.145
	1					LS73P73D11	1SBV 01 2873 R1411	0.145
		1				LS73P73C11	1SBV 01 2873 R1511	0.145
			1			LS73P73L02	1SBV 01 2873 R1302	0.145
				1		LS73P73L20	1SBV 01 2873 R1320	0.145
					1	LS73P73B02	1SBV 01 2873 R1202	0.145
1						LS75P73B11	1SBV 01 2773 R1211	0.152
	1					LS75P73D11	1SBV 01 2773 R1411	0.152
		1				LS75P73C11	1SBV 01 2773 R1511	0.152
			1			LS75P73L02	1SBV 01 2773 R1302	0.152
				1		LS75P73L20	1SBV 01 2773 R1320	0.152
					1	LS75P73B02	1SBV 01 2773 R1202	0.152

Adjustable ø6 fibre-glass rod lever

1						LS72P74B11	1SBV 01 1074 R1211	0.145
	1					LS72P74D11	1SBV 01 1074 R1411	0.145
		1				LS72P74C11	1SBV 01 1074 R1511	0.145
			1			LS72P74L02	1SBV 01 1074 R1302	0.145
				1		LS72P74L20	1SBV 01 1074 R1320	0.145
					1	LS72P74B02	1SBV 01 1074 R1202	0.145
1						LS73P74B11	1SBV 01 2874 R1211	0.145
	1					LS73P74D11	1SBV 01 2874 R1411	0.145
		1				LS73P74C11	1SBV 01 2874 R1511	0.145
			1			LS73P74L02	1SBV 01 2874 R1302	0.145
				1		LS73P74L20	1SBV 01 2874 R1320	0.145
					1	LS73P74B02	1SBV 01 2874 R1202	0.145
1						LS75P74B11	1SBV 01 2774 R1211	0.152
	1					LS75P74D11	1SBV 01 2774 R1411	0.152
		1				LS75P74C11	1SBV 01 2774 R1511	0.152
			1			LS75P74L02	1SBV 01 2774 R1302	0.152
				1		LS75P74L20	1SBV 01 2774 R1320	0.152
					1	LS75P74B02	1SBV 01 2774 R1202	0.152

Adjustable 3 square steel rod lever (zinc-plated)

1						LS72P78B11	1SBV 01 1078 R1211	0.125
	1					LS72P78D11	1SBV 01 1078 R1411	0.125
		1				LS72P78C11	1SBV 01 1078 R1511	0.125
			1			LS72P78L02	1SBV 01 1078 R1302	0.125
				1		LS72P78L20	1SBV 01 1078 R1320	0.125
					1	LS72P78B02	1SBV 01 1078 R1202	0.125
1						LS73P78B11	1SBV 01 2878 R1211	0.125
	1					LS73P78D11	1SBV 01 2878 R1411	0.125
		1				LS73P78C11	1SBV 01 2878 R1511	0.125
			1			LS73P78L02	1SBV 01 2878 R1302	0.125
				1		LS73P78L20	1SBV 01 2878 R1320	0.125
					1	LS73P78B02	1SBV 01 2878 R1202	0.125
1						LS75P78B11	1SBV 01 2778 R1211	0.132
	1					LS75P78D11	1SBV 01 2778 R1411	0.132
		1				LS75P78C11	1SBV 01 2778 R1511	0.132
			1			LS75P78L02	1SBV 01 2778 R1302	0.132
				1		LS75P78L20	1SBV 01 2778 R1320	0.132
					1	LS75P78B02	1SBV 01 2778 R1202	0.132

>> Technical Data, Dimensions page 39

>> Accessories page 76

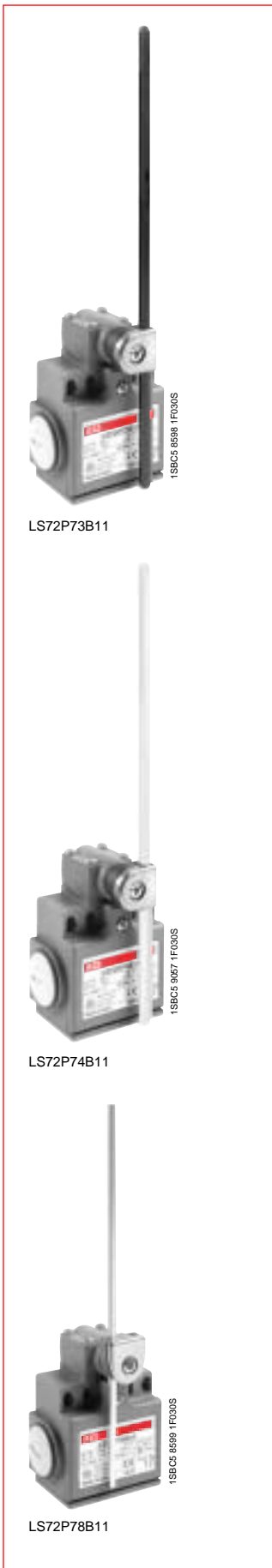

LS72P..., LS73P... and LS75P... Limit Switches

Double Insulation - Plastic Casing IP65 - 60 mm Width

LS72P with 2 cable inlets M16 x 1.5 for ISO 16 cable gland.
 LS73P with 2 cable inlets M20 x 1.5 for ISO 20 cable gland.
 LS75P with 1 cable inlet by 1/2" NPT plastic adaptor + 1 cable inlet Pg11 for additional 1/2" NPT plastic adaptor (on request).

Ordering Details

Contact blocks						Type	Order code	Unit weight kg Packing 1 piece
B11	D11	C11	L02	L20	B02			

Spring rod

1						LS72P91B11	1SBV 01 1091 R1211	0.110
	1					LS72P91D11	1SBV 01 1091 R1411	0.110
		1				LS72P91C11	1SBV 01 1091 R1511	0.110
			1			LS72P91L02	1SBV 01 1091 R1302	0.110
				1		LS72P91L20	1SBV 01 1091 R1320	0.110
					1	LS72P91B02	1SBV 01 1091 R1202	0.110
1						LS73P91B11	1SBV 01 2891 R1211	0.110
	1					LS73P91D11	1SBV 01 2891 R1411	0.110
		1				LS73P91C11	1SBV 01 2891 R1511	0.110
			1			LS73P91L02	1SBV 01 2891 R1302	0.110
				1		LS73P91L20	1SBV 01 2891 R1320	0.110
					1	LS73P91B02	1SBV 01 2891 R1202	0.110
1						LS75P91B11	1SBV 01 2791 R1211	0.117
	1					LS75P91D11	1SBV 01 2791 R1411	0.117
		1				LS75P91C11	1SBV 01 2791 R1511	0.117
			1			LS75P91L02	1SBV 01 2791 R1302	0.117
				1		LS75P91L20	1SBV 01 2791 R1320	0.117
					1	LS75P91B02	1SBV 01 2791 R1202	0.117

Flexible rod with insulated end

1						LS72P92B11	1SBV 01 1092 R1211	0.115
	1					LS72P92D11	1SBV 01 1092 R1411	0.115
		1				LS72P92C11	1SBV 01 1092 R1511	0.115
			1			LS72P92L02	1SBV 01 1092 R1302	0.115
				1		LS72P92L20	1SBV 01 1092 R1320	0.115
					1	LS72P92B02	1SBV 01 1092 R1202	0.115
1						LS73P92B11	1SBV 01 2892 R1211	0.115
	1					LS73P92D11	1SBV 01 2892 R1411	0.115
		1				LS73P92C11	1SBV 01 2892 R1511	0.115
			1			LS73P92L02	1SBV 01 2892 R1302	0.115
				1		LS73P92L20	1SBV 01 2892 R1320	0.115
					1	LS73P92B02	1SBV 01 2892 R1202	0.115
1						LS75P92B11	1SBV 01 2792 R1211	0.122
	1					LS75P92D11	1SBV 01 2792 R1411	0.122
		1				LS75P92C11	1SBV 01 2792 R1511	0.122
			1			LS75P92L02	1SBV 01 2792 R1302	0.122
				1		LS75P92L20	1SBV 01 2792 R1320	0.122
					1	LS75P92B02	1SBV 01 2792 R1202	0.122

Pull action with ring

1						LS72P98B11-A	1SBV 01 1098 R1211	0.145
	1					LS72P98D11-A	1SBV 01 1098 R1411	0.145
			1			LS72P98L02-A	1SBV 01 1098 R1302	0.145
				1		LS72P98L20-A	1SBV 01 1098 R1320	0.145
1						LS73P98B11-A	1SBV 01 2898 R1211	0.145
	1					LS73P98D11-A	1SBV 01 2898 R1411	0.145
			1			LS73P98L02-A	1SBV 01 2898 R1302	0.145
				1		LS73P98L20-A	1SBV 01 2898 R1320	0.145
1						LS75P98B11-A	1SBV 01 2798 R1211	0.152
	1					LS75P98D11-A	1SBV 01 2798 R1411	0.152
			1			LS75P98L02-A	1SBV 01 2798 R1302	0.152
				1		LS75P98L20-A	1SBV 01 2798 R1320	0.152

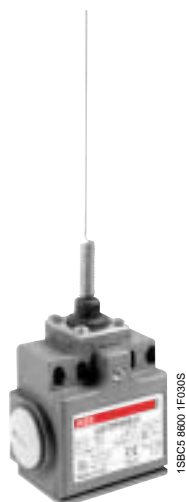

LS72P91B11



LS72P92B11



LS72P98B11-A

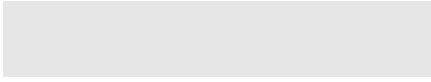

LSB 74R1320

LS35M73C



HLJ12-LG27-B	15BU 23 0030 R4421	34
HLJ12-LG27-C	15BU 23 0030 R4717	34
HLJ12-LG27-D	15BU 23 0030 R4721	34
HLJ12-LG27-E	15BU 23 0030 R4251	34
HLJ12-LG27-F	15BU 23 0030 R4261	34
HLJ12-LG27-G	15BU 23 0030 R4451	34
HLJ12-LG27-H	15BU 23 0030 R4461	34
HLJ12-LG27-I	15BU 23 0030 R4751	34
HLJ12-LG27-J	15BU 23 0030 R4761	34
HLJ12-LG27-K	15BU 23 0030 R4231	34
HLJ12-LG27-L	15BU 23 0030 R4241	34
HLJ12-LG27-M	15BU 23 0030 R4431	34
HLJ12-LG27-N	15BU 23 0030 R4441	34
HLJ12-LG27-O	15BU 23 0030 R4731	34
HLJ12-LG27-P	15BU 23 0030 R4741	34
HLJ12-LG27-Q	15BU 23 0030 R4213	34
HLJ12-LG27-R	15BU 23 0030 R4223	34
HLJ12-LG27-S	15BU 23 0030 R4413	34
HLJ12-LG27-T	15BU 23 0030 R4423	34
HLJ12-LG27-U	15BU 23 0030 R4713	34
HLJ12-LG27-V	15BU 23 0030 R4723	34
HLJ12-LG27-W	15BU 23 0030 R4253	34
HLJ12-LG27-X	15BU 23 0030 R4263	34
HLJ12-LG27-Y	15BU 23 0030 R4453	34
HLJ12-LG27-Z	15BU 23 0030 R4463	34
HLJ12-LG27-AA	15BU 23 0030 R4753	34
HLJ12-LG27-AB	15BU 23 0030 R4763	34
HLJ12-LG27-AC	15BU 23 0030 R4233	34
HLJ12-LG27-AD	15BU 23 0030 R4243	34
HLJ12-LG27-AE	15BU 23 0030 R4433	34
HLJ12-LG27-AF	15BU 23 0030 R4443	34
HLJ12-LG27-AG	15BU 23 0030 R4733	34
HLJ12-LG27-AH	15BU 23 0030 R4743	34
HLJ12-LG27-AI	15BU 23 0030 R4211	34
HLJ12-LG27-AJ	15BU 23 0030 R4221	34
HLJ12-LG27-AK	15BU 23 0030 R4411	34
HLJ12-LG27-AL	15BU 23 0030 R4421	34
HLJ12-LG27-AM	15BU 23 0030 R4711	34
HLJ12-LG27-AN	15BU 23 0030 R4721	34
HLJ12-LG27-AO	15BU 23 0030 R4251	34
HLJ12-LG27-AP	15BU 23 0030 R4261	34
HLJ12-LG27-AQ	15BU 23 0030 R4451	34
HLJ12-LG27-AR	15BU 23 0030 R4461	34
HLJ12-LG27-AS	15BU 23 0030 R4751	34
HLJ12-LG27-AT	15BU 23 0030 R4761	34
HLJ12-LG27-AU	15BU 23 0030 R4231	34

IE241C	15BU 37 1010 R4002	56
IE241F	15BU 37 1000 R4001	56
IE242C	15BU 37 1010 R4004	56
IE242F	15BU 37 1000 R4003	56
IE243C	15BU 37 1010 R4006	56
IE243F	15BU 37 1000 R4005	56
IE291C	15BU 37 1010 R4008	56
IE291F	15BU 37 1000 R4007	56
IE292C	15BU 37 1010 R4010	56
IE292F	15BU 37 1000 R4009	56
IE293C	15BU 37 1010 R4012	56
IE293F	15BU 37 1000 R4011	56



15BU 20 0000 R3101	41
15BU 20 0000 R3111	41
15BU 20 0000 R3151	41
15BU 20 0000 R3155	41
15BU 20 0000 R3110	41
15BU 20 0000 R3150	41
15BU 53 3110 T4021	41
15BU 53 3110 T4012	41

Index

Classification by Type

Type	Order Code	Page	Type	Order Code	Page	Type	Order Code	Page
LS32M11...			LS32M45...			LS32M78...		
LS32M11B02	1SBV 01 1911 R1202	52	LS32M45B02	1SBV 01 1945 R1202	55	LS32M78B02	1SBV 01 1978 R1202	58
LS32M11B11	1SBV 01 1911 R1211	52	LS32M45B11	1SBV 01 1945 R1211	55	LS32M78B11	1SBV 01 1978 R1211	58
LS32M11C11	1SBV 01 1911 R1511	52	LS32M45C11	1SBV 01 1945 R1511	55	LS32M78C11	1SBV 01 1978 R1511	58
LS32M11D11	1SBV 01 1911 R1411	52	LS32M45D11	1SBV 01 1945 R1411	55	LS32M78D11	1SBV 01 1978 R1411	58
LS32M11L02	1SBV 01 1911 R1302	52	LS32M45L02	1SBV 01 1945 R1302	55	LS32M78L02	1SBV 01 1978 R1302	58
LS32M11L20	1SBV 01 1911 R1320	52	LS32M45L20	1SBV 01 1945 R1320	55	LS32M78L20	1SBV 01 1978 R1320	58
LS32M12...			LS32M46...			LS32M91...		
LS32M12B02	1SBV 01 1912 R1202	52	LS32M46B02	1SBV 01 1946 R1202	55	LS32M91B02	1SBV 01 1991 R1202	59
LS32M12B11	1SBV 01 1912 R1211	52	LS32M46B11	1SBV 01 1946 R1211	55	LS32M91B11	1SBV 01 1991 R1211	59
LS32M12C11	1SBV 01 1912 R1511	52	LS32M46C11	1SBV 01 1946 R1511	55	LS32M91C11	1SBV 01 1991 R1511	59
LS32M12D11	1SBV 01 1912 R1411	52	LS32M46D11	1SBV 01 1946 R1411	55	LS32M91D11	1SBV 01 1991 R1411	59
LS32M12L02	1SBV 01 1912 R1302	52	LS32M46L02	1SBV 01 1946 R1302	55	LS32M91L02	1SBV 01 1991 R1302	59
LS32M12L20	1SBV 01 1912 R1320	52	LS32M46L20	1SBV 01 1946 R1320	55	LS32M91L20	1SBV 01 1991 R1320	59
LS32M13...			LS32M51...			LS32M92...		
LS32M13B02	1SBV 01 1913 R1202	52	LS32M51B02	1SBV 01 1951 R1202	56	LS32M92B02	1SBV 01 1992 R1202	59
LS32M13B11	1SBV 01 1913 R1211	52	LS32M51B11	1SBV 01 1951 R1211	56	LS32M92B11	1SBV 01 1992 R1211	59
LS32M13C11	1SBV 01 1913 R1511	52	LS32M51C11	1SBV 01 1951 R1511	56	LS32M92C11	1SBV 01 1992 R1511	59
LS32M13D11	1SBV 01 1913 R1411	52	LS32M51D11	1SBV 01 1951 R1411	56	LS32M92D11	1SBV 01 1992 R1411	59
LS32M13L02	1SBV 01 1913 R1302	52	LS32M51L02	1SBV 01 1951 R1302	56	LS32M92L02	1SBV 01 1992 R1302	59
LS32M13L20	1SBV 01 1913 R1320	52	LS32M51L20	1SBV 01 1951 R1320	56	LS32M92L20	1SBV 01 1992 R1320	59
LS32M14...			LS32M52...			LS32M98...		
LS32M14B02	1SBV 01 1914 R1202	53	LS32M52B02	1SBV 01 1952 R1202	56	LS32M98B11-A	1SBV 01 1998 R1211	59
LS32M14B11	1SBV 01 1914 R1211	53	LS32M52B11	1SBV 01 1952 R1211	56	LS32M98D11-A	1SBV 01 1998 R1411	59
LS32M14C11	1SBV 01 1914 R1511	53	LS32M52C11	1SBV 01 1952 R1511	56	LS32M98L02-A	1SBV 01 1998 R1302	59
LS32M14D11	1SBV 01 1914 R1411	53	LS32M52D11	1SBV 01 1952 R1411	56	LS32M98L20-A	1SBV 01 1998 R1320	59
LS32M14L02	1SBV 01 1914 R1302	53	LS32M52L02	1SBV 01 1952 R1302	56			
LS32M14L20	1SBV 01 1914 R1320	53	LS32M52L20	1SBV 01 1952 R1320	56			
LS32M31...			LS32M53...			LS33M11...		
LS32M31B02	1SBV 01 1931 R1202	53	LS32M53B02	1SBV 01 1953 R1202	56	LS33M11B02	1SBV 01 3811 R1202	52
LS32M31B11	1SBV 01 1931 R1211	53	LS32M53B11	1SBV 01 1953 R1211	56	LS33M11B11	1SBV 01 3811 R1211	52
LS32M31C11	1SBV 01 1931 R1511	53	LS32M53C11	1SBV 01 1953 R1511	56	LS33M11C11	1SBV 01 3811 R1511	52
LS32M31D11	1SBV 01 1931 R1411	53	LS32M53D11	1SBV 01 1953 R1411	56	LS33M11D11	1SBV 01 3811 R1411	52
LS32M31L02	1SBV 01 1931 R1302	53	LS32M53L02	1SBV 01 1953 R1302	56	LS33M11L02	1SBV 01 3811 R1302	52
LS32M31L20	1SBV 01 1931 R1320	53	LS32M53L20	1SBV 01 1953 R1320	56	LS33M11L20	1SBV 01 3811 R1320	52
LS32M32...			LS32M55...			LS33M12...		
LS32M32B02	1SBV 01 1932 R1202	53	LS32M55B02	1SBV 01 1955 R1202	57	LS33M12B02	1SBV 01 3812 R1202	52
LS32M32B11	1SBV 01 1932 R1211	53	LS32M55B11	1SBV 01 1955 R1211	57	LS33M12B11	1SBV 01 3812 R1211	52
LS32M32C11	1SBV 01 1932 R1511	53	LS32M55C11	1SBV 01 1955 R1511	57	LS33M12C11	1SBV 01 3812 R1511	52
LS32M32D11	1SBV 01 1932 R1411	53	LS32M55D11	1SBV 01 1955 R1411	57	LS33M12D11	1SBV 01 3812 R1411	52
LS32M32L02	1SBV 01 1932 R1302	53	LS32M55L02	1SBV 01 1955 R1302	57	LS33M12L02	1SBV 01 3812 R1302	52
LS32M32L20	1SBV 01 1932 R1320	53	LS32M55L20	1SBV 01 1955 R1320	57	LS33M12L20	1SBV 01 3812 R1320	52
LS32M38...			LS32M71...			LS33M13...		
LS32M38B02	1SBV 01 1938 R1202	54	LS32M71B02	1SBV 01 1971 R1202	57	LS33M13B02	1SBV 01 3813 R1202	52
LS32M38B11	1SBV 01 1938 R1211	54	LS32M71B11	1SBV 01 1971 R1211	57	LS33M13B11	1SBV 01 3813 R1211	52
LS32M38C11	1SBV 01 1938 R1511	54	LS32M71C11	1SBV 01 1971 R1511	57	LS33M13C11	1SBV 01 3813 R1511	52
LS32M38D11	1SBV 01 1938 R1411	54	LS32M71D11	1SBV 01 1971 R1411	57	LS33M13D11	1SBV 01 3813 R1411	52
LS32M38L02	1SBV 01 1938 R1302	54	LS32M71L02	1SBV 01 1971 R1302	57	LS33M13L02	1SBV 01 3813 R1302	52
LS32M38L20	1SBV 01 1938 R1320	54	LS32M71L20	1SBV 01 1971 R1320	57	LS33M13L20	1SBV 01 3813 R1320	52
LS32M41...			LS32M72...			LS33M14...		
LS32M41B02	1SBV 01 1941 R1202	54	LS32M72B02	1SBV 01 1972 R1202	57	LS33M14B02	1SBV 01 3814 R1202	53
LS32M41B11	1SBV 01 1941 R1211	54	LS32M72B11	1SBV 01 1972 R1211	57	LS33M14B11	1SBV 01 3814 R1211	53
LS32M41C11	1SBV 01 1941 R1511	54	LS32M72C11	1SBV 01 1972 R1511	57	LS33M14C11	1SBV 01 3814 R1511	53
LS32M41D11	1SBV 01 1941 R1411	54	LS32M72D11	1SBV 01 1972 R1411	57	LS33M14D11	1SBV 01 3814 R1411	53
LS32M41L02	1SBV 01 1941 R1302	54	LS32M72L02	1SBV 01 1972 R1302	57	LS33M14L02	1SBV 01 3814 R1302	53
LS32M41L20	1SBV 01 1941 R1320	54	LS32M72L20	1SBV 01 1972 R1320	57	LS33M14L20	1SBV 01 3814 R1320	53
LS32M42...			LS32M73...			LS33M31...		
LS32M42B02	1SBV 01 1942 R1202	54	LS32M73B02	1SBV 01 1973 R1202	58	LS33M31B02	1SBV 01 3831 R1202	53
LS32M42B11	1SBV 01 1942 R1211	54	LS32M73B11	1SBV 01 1973 R1211	58	LS33M31B11	1SBV 01 3831 R1211	53
LS32M42C11	1SBV 01 1942 R1511	54	LS32M73C11	1SBV 01 1973 R1511	58	LS33M31C11	1SBV 01 3831 R1511	53
LS32M42D11	1SBV 01 1942 R1411	54	LS32M73D11	1SBV 01 1973 R1411	58	LS33M31D11	1SBV 01 3831 R1411	53
LS32M42L02	1SBV 01 1942 R1302	54	LS32M73L02	1SBV 01 1973 R1302	58	LS33M31L02	1SBV 01 3831 R1302	53
LS32M42L20	1SBV 01 1942 R1320	54	LS32M73L20	1SBV 01 1973 R1320	58	LS33M31L20	1SBV 01 3831 R1320	53
LS32M43...			LS32M74...			LS33M32...		
LS32M43B02	1SBV 01 1943 R1202	55	LS32M74B02	1SBV 01 1974 R1202	58	LS33M32B02	1SBV 01 3832 R1202	53
LS32M43B11	1SBV 01 1943 R1211	55	LS32M74B11	1SBV 01 1974 R1211	58	LS33M32B11	1SBV 01 3832 R1211	53
LS32M43C11	1SBV 01 1943 R1511	55	LS32M74C11	1SBV 01 1974 R1511	58	LS33M32C11	1SBV 01 3832 R1511	53
LS32M43D11	1SBV 01 1943 R1411	55	LS32M74D11	1SBV 01 1974 R1411	58	LS33M32D11	1SBV 01 3832 R1411	53
LS32M43L02	1SBV 01 1943 R1302	55	LS32M74L02	1SBV 01 1974 R1302	58	LS33M32L02	1SBV 01 3832 R1302	53
LS32M43L20	1SBV 01 1943 R1320	55	LS32M74L20	1SBV 01 1974 R1320	58	LS33M32L20	1SBV 01 3832 R1320	53

Index

Classification by Type

Type	Order Code	Page	Type	Order Code	Page	Type	Order Code	Page
LS33M38...			LS33M71...			LS35M13...		
LS33M38B02	1SBV 01 3838 R1202	54	LS33M71B02	1SBV 01 3871 R1202	57	LS35M13B02	1SBV 01 3713 R1202	52
LS33M38B11	1SBV 01 3838 R1211	54	LS33M71B11	1SBV 01 3871 R1211	57	LS35M13B11	1SBV 01 3713 R1211	52
LS33M38C11	1SBV 01 3838 R1511	54	LS33M71C11	1SBV 01 3871 R1511	57	LS35M13C11	1SBV 01 3713 R1511	52
LS33M38D11	1SBV 01 3838 R1411	54	LS33M71D11	1SBV 01 3871 R1411	57	LS35M13D11	1SBV 01 3713 R1411	52
LS33M38L02	1SBV 01 3838 R1302	54	LS33M71L02	1SBV 01 3871 R1302	57	LS35M13L02	1SBV 01 3713 R1302	52
LS33M38L20	1SBV 01 3838 R1320	54	LS33M71L20	1SBV 01 3871 R1320	57	LS35M13L20	1SBV 01 3713 R1320	52
LS33M41...			LS33M72...			LS35M14...		
LS33M41B02	1SBV 01 3841 R1202	54	LS33M72B02	1SBV 01 3872 R1202	57	LS35M14B02	1SBV 01 3714 R1202	53
LS33M41B11	1SBV 01 3841 R1211	54	LS33M72B11	1SBV 01 3872 R1211	57	LS35M14B11	1SBV 01 3714 R1211	53
LS33M41C11	1SBV 01 3841 R1511	54	LS33M72C11	1SBV 01 3872 R1511	57	LS35M14C11	1SBV 01 3714 R1511	53
LS33M41D11	1SBV 01 3841 R1411	54	LS33M72D11	1SBV 01 3872 R1411	57	LS35M14D11	1SBV 01 3714 R1411	53
LS33M41L02	1SBV 01 3841 R1302	54	LS33M72L02	1SBV 01 3872 R1302	57	LS35M14L02	1SBV 01 3714 R1302	53
LS33M41L20	1SBV 01 3841 R1320	54	LS33M72L20	1SBV 01 3872 R1320	57	LS35M14L20	1SBV 01 3714 R1320	53
LS33M42...			LS33M73...			LS35M31...		
LS33M42B02	1SBV 01 3842 R1202	54	LS33M73B02	1SBV 01 3873 R1202	58	LS35M31B02	1SBV 01 3731 R1202	53
LS33M42B11	1SBV 01 3842 R1211	54	LS33M73B11	1SBV 01 3873 R1211	58	LS35M31B11	1SBV 01 3731 R1211	53
LS33M42C11	1SBV 01 3842 R1511	54	LS33M73C11	1SBV 01 3873 R1511	58	LS35M31C11	1SBV 01 3731 R1511	53
LS33M42D11	1SBV 01 3842 R1411	54	LS33M73D11	1SBV 01 3873 R1411	58	LS35M31D11	1SBV 01 3731 R1411	53
LS33M42L02	1SBV 01 3842 R1302	54	LS33M73L02	1SBV 01 3873 R1302	58	LS35M31L02	1SBV 01 3731 R1302	53
LS33M42L20	1SBV 01 3842 R1320	54	LS33M73L20	1SBV 01 3873 R1320	58	LS35M31L20	1SBV 01 3731 R1320	53
LS33M43...			LS33M74...			LS35M32...		
LS33M43B02	1SBV 01 3843 R1202	55	LS33M74B02	1SBV 01 3874 R1202	58	LS35M32B02	1SBV 01 3732 R1202	53
LS33M43B11	1SBV 01 3843 R1211	55	LS33M74B11	1SBV 01 3874 R1211	58	LS35M32B11	1SBV 01 3732 R1211	53
LS33M43C11	1SBV 01 3843 R1511	55	LS33M74C11	1SBV 01 3874 R1511	58	LS35M32C11	1SBV 01 3732 R1511	53
LS33M43D11	1SBV 01 3843 R1411	55	LS33M74D11	1SBV 01 3874 R1411	58	LS35M32D11	1SBV 01 3732 R1411	53
LS33M43L02	1SBV 01 3843 R1302	55	LS33M74L02	1SBV 01 3874 R1302	58	LS35M32L02	1SBV 01 3732 R1302	53
LS33M43L20	1SBV 01 3843 R1320	55	LS33M74L20	1SBV 01 3874 R1320	58	LS35M32L20	1SBV 01 3732 R1320	53
LS33M45...			LS33M78 ...			LS35M38...		
LS33M45B02	1SBV 01 3845 R1202	55	LS33M78B02	1SBV 01 3878 R1202	58	LS35M38B02	1SBV 01 3738 R1202	54
LS33M45B11	1SBV 01 3845 R1211	55	LS33M78B11	1SBV 01 3878 R1211	58	LS35M38B11	1SBV 01 3738 R1211	54
LS33M45C11	1SBV 01 3845 R1511	55	LS33M78C11	1SBV 01 3878 R1511	58	LS35M38C11	1SBV 01 3738 R1511	54
LS33M45D11	1SBV 01 3845 R1411	55	LS33M78D11	1SBV 01 3878 R1411	58	LS35M38D11	1SBV 01 3738 R1411	54
LS33M45L02	1SBV 01 3845 R1302	55	LS33M78L02	1SBV 01 3878 R1302	58	LS35M38L02	1SBV 01 3738 R1302	54
LS33M45L20	1SBV 01 3845 R1320	55	LS33M78L20	1SBV 01 3878 R1320	58	LS35M38L20	1SBV 01 3738 R1320	54
LS33M46...			LS33M91...			LS35M41...		
LS33M46B02	1SBV 01 3846 R1202	55	LS33M91B02	1SBV 01 3891 R1202	59	LS35M41B02	1SBV 01 3741 R1202	54
LS33M46B11	1SBV 01 3846 R1211	55	LS33M91B11	1SBV 01 3891 R1211	59	LS35M41B11	1SBV 01 3741 R1211	54
LS33M46C11	1SBV 01 3846 R1511	55	LS33M91C11	1SBV 01 3891 R1511	59	LS35M41C11	1SBV 01 3741 R1511	54
LS33M46D11	1SBV 01 3846 R1411	55	LS33M91D11	1SBV 01 3891 R1411	59	LS35M41D11	1SBV 01 3741 R1411	54
LS33M46L02	1SBV 01 3846 R1302	55	LS33M91L02	1SBV 01 3891 R1302	59	LS35M41L02	1SBV 01 3741 R1302	54
LS33M46L20	1SBV 01 3846 R1320	55	LS33M91L20	1SBV 01 3891 R1320	59	LS35M41L20	1SBV 01 3741 R1320	54
LS33M51...			LS33M92...			LS35M42...		
LS33M51B02	1SBV 01 3851 R1202	56	LS33M92B02	1SBV 01 3892 R1202	59	LS35M42B02	1SBV 01 3742 R1202	54
LS33M51B11	1SBV 01 3851 R1211	56	LS33M92B11	1SBV 01 3892 R1211	59	LS35M42B11	1SBV 01 3742 R1211	54
LS33M51C11	1SBV 01 3851 R1511	56	LS33M92C11	1SBV 01 3892 R1511	59	LS35M42C11	1SBV 01 3742 R1511	54
LS33M51D11	1SBV 01 3851 R1411	56	LS33M92D11	1SBV 01 3892 R1411	59	LS35M42D11	1SBV 01 3742 R1411	54
LS33M51L02	1SBV 01 3851 R1302	56	LS33M92L02	1SBV 01 3892 R1302	59	LS35M42L02	1SBV 01 3742 R1302	54
LS33M51L20	1SBV 01 3851 R1320	56	LS33M92L20	1SBV 01 3892 R1320	59	LS35M42L20	1SBV 01 3742 R1320	54
LS33M52...			LS33M98...			LS35M43...		
LS33M52B02	1SBV 01 3852 R1202	56	LS33M98B11-A	1SBV 01 3898 R1211	59	LS35M43B02	1SBV 01 3743 R1202	55
LS33M52B11	1SBV 01 3852 R1211	56	LS33M98D11-A	1SBV 01 3898 R1411	59	LS35M43B11	1SBV 01 3743 R1211	55
LS33M52C11	1SBV 01 3852 R1511	56	LS33M98L02-A	1SBV 01 3898 R1302	59	LS35M43C11	1SBV 01 3743 R1511	55
LS33M52D11	1SBV 01 3852 R1411	56	LS33M98L20-A	1SBV 01 3898 R1320	59	LS35M43D11	1SBV 01 3743 R1411	55
LS33M52L02	1SBV 01 3852 R1302	56				LS35M43L02	1SBV 01 3743 R1302	55
LS33M52L20	1SBV 01 3852 R1320	56				LS35M43L20	1SBV 01 3743 R1320	55
LS33M53...			LS35M11...			LS35M45...		
LS33M53B02	1SBV 01 3853 R1202	56	LS35M11B02	1SBV 01 3711 R1202	52	LS35M45B02	1SBV 01 3745 R1202	55
LS33M53B11	1SBV 01 3853 R1211	56	LS35M11B11	1SBV 01 3711 R1211	52	LS35M45B11	1SBV 01 3745 R1211	55
LS33M53C11	1SBV 01 3853 R1511	56	LS35M11C11	1SBV 01 3711 R1511	52	LS35M45C11	1SBV 01 3745 R1511	55
LS33M53D11	1SBV 01 3853 R1411	56	LS35M11D11	1SBV 01 3711 R1411	52	LS35M45D11	1SBV 01 3745 R1411	55
LS33M53L02	1SBV 01 3853 R1302	56	LS35M11L02	1SBV 01 3711 R1302	52	LS35M45L02	1SBV 01 3745 R1302	55
LS33M53L20	1SBV 01 3853 R1320	56	LS35M11L20	1SBV 01 3711 R1320	52	LS35M45L20	1SBV 01 3745 R1320	55
LS33M55...			LS35M12...			LS35M46...		
LS33M55B02	1SBV 01 3855 R1202	57	LS35M12B02	1SBV 01 3712 R1202	52	LS35M46B02	1SBV 01 3746 R1202	55
LS33M55B11	1SBV 01 3855 R1211	57	LS35M12B11	1SBV 01 3712 R1211	52	LS35M46B11	1SBV 01 3746 R1211	55
LS33M55C11	1SBV 01 3855 R1511	57	LS35M12C11	1SBV 01 3712 R1511	52	LS35M46C11	1SBV 01 3746 R1511	55
LS33M55D11	1SBV 01 3855 R1411	57	LS35M12D11	1SBV 01 3712 R1411	52	LS35M46D11	1SBV 01 3746 R1411	55
LS33M55L02	1SBV 01 3855 R1302	57	LS35M12L02	1SBV 01 3712 R1302	52	LS35M46L02	1SBV 01 3746 R1302	55
LS33M55L20	1SBV 01 3855 R1320	57	LS35M12L20	1SBV 01 3712 R1320	52	LS35M46L20	1SBV 01 3746 R1320	55

Index

Classification by Type

Type	Order Code	Page	Type	Order Code	Page	Type	Order Code	Page
LS35M51...			LS35M92...			LS72M43...		
LS35M51B02	1SBV 01 3751 R1202	56	LS35M92B02	1SBV 01 3792 R1202	59	LS72M43B02	1SBV 01 4343 R1202	62
LS35M51B11	1SBV 01 3751 R1211	56	LS35M92B11	1SBV 01 3792 R1211	59	LS72M43B11	1SBV 01 4343 R1211	62
LS35M51C11	1SBV 01 3751 R1511	56	LS35M92C11	1SBV 01 3792 R1511	59	LS72M43C11	1SBV 01 4343 R1511	62
LS35M51D11	1SBV 01 3751 R1411	56	LS35M92D11	1SBV 01 3792 R1411	59	LS72M43D11	1SBV 01 4343 R1411	62
LS35M51L02	1SBV 01 3751 R1302	56	LS35M92L02	1SBV 01 3792 R1302	59	LS72M43L02	1SBV 01 4343 R1302	62
LS35M51L20	1SBV 01 3751 R1320	56	LS35M92L20	1SBV 01 3792 R1320	59	LS72M43L20	1SBV 01 4343 R1320	62
LS35M52...			LS35M98...			LS72M45...		
LS35M52B02	1SBV 01 3752 R1202	56	LS35M98B11-A	1SBV 01 3798 R1211	59	LS72M45B02	1SBV 01 4345 R1202	63
LS35M52B11	1SBV 01 3752 R1211	56	LS35M98D11-A	1SBV 01 3798 R1411	59	LS72M45B11	1SBV 01 4345 R1211	63
LS35M52C11	1SBV 01 3752 R1511	56	LS35M98L02-A	1SBV 01 3798 R1302	59	LS72M45C11	1SBV 01 4345 R1511	63
LS35M52D11	1SBV 01 3752 R1411	56	LS35M98L20-A	1SBV 01 3798 R1320	59	LS72M45D11	1SBV 01 4345 R1411	63
LS35M52L02	1SBV 01 3752 R1302	56				LS72M45L02	1SBV 01 4345 R1302	63
LS35M52L20	1SBV 01 3752 R1320	56				LS72M45L20	1SBV 01 4345 R1320	63
LS35M53...			LS72M11...			LS72M46...		
LS35M53B02	1SBV 01 3753 R1202	56	LS72M11B02	1SBV 01 4311 R1202	60	LS72M46B02	1SBV 01 4346 R1202	63
LS35M53B11	1SBV 01 3753 R1211	56	LS72M11B11	1SBV 01 4311 R1211	60	LS72M46B11	1SBV 01 4346 R1211	63
LS35M53C11	1SBV 01 3753 R1511	56	LS72M11C11	1SBV 01 4311 R1511	60	LS72M46C11	1SBV 01 4346 R1511	63
LS35M53D11	1SBV 01 3753 R1411	56	LS72M11D11	1SBV 01 4311 R1411	60	LS72M46D11	1SBV 01 4346 R1411	63
LS35M53L02	1SBV 01 3753 R1302	56	LS72M11L02	1SBV 01 4311 R1302	60	LS72M46L02	1SBV 01 4346 R1302	63
LS35M53L20	1SBV 01 3753 R1320	56	LS72M11L20	1SBV 01 4311 R1320	60	LS72M46L20	1SBV 01 4346 R1320	63
LS35M55...			LS72M12...			LS72M51...		
LS35M55B02	1SBV 01 3755 R1202	57	LS72M12B02	1SBV 01 4312 R1202	60	LS72M51B02	1SBV 01 4351 R1202	63
LS35M55B11	1SBV 01 3755 R1211	57	LS72M12B11	1SBV 01 4312 R1211	60	LS72M51B11	1SBV 01 4351 R1211	63
LS35M55C11	1SBV 01 3755 R1511	57	LS72M12C11	1SBV 01 4312 R1511	60	LS72M51C11	1SBV 01 4351 R1511	63
LS35M55D11	1SBV 01 3755 R1411	57	LS72M12D11	1SBV 01 4312 R1411	60	LS72M51D11	1SBV 01 4351 R1411	63
LS35M55L02	1SBV 01 3755 R1302	57	LS72M12L02	1SBV 01 4312 R1302	60	LS72M51L02	1SBV 01 4351 R1302	63
LS35M55L20	1SBV 01 3755 R1320	57	LS72M12L20	1SBV 01 4312 R1320	60	LS72M51L20	1SBV 01 4351 R1320	63
LS35M71...			LS72M13...			LS72M52...		
LS35M71B02	1SBV 01 3771 R1202	57	LS72M13B02	1SBV 01 4313 R1202	60	LS72M52B02	1SBV 01 4352 R1202	64
LS35M71B11	1SBV 01 3771 R1211	57	LS72M13B11	1SBV 01 4313 R1211	60	LS72M52B11	1SBV 01 4352 R1211	64
LS35M71C11	1SBV 01 3771 R1511	57	LS72M13C11	1SBV 01 4313 R1511	60	LS72M52C11	1SBV 01 4352 R1511	64
LS35M71D11	1SBV 01 3771 R1411	57	LS72M13D11	1SBV 01 4313 R1411	60	LS72M52D11	1SBV 01 4352 R1411	64
LS35M71L02	1SBV 01 3771 R1302	57	LS72M13L02	1SBV 01 4313 R1302	60	LS72M52L02	1SBV 01 4352 R1302	64
LS35M71L20	1SBV 01 3771 R1320	57	LS72M13L20	1SBV 01 4313 R1320	60	LS72M52L20	1SBV 01 4352 R1320	64
LS35M72...			LS72M31...			LS72M53...		
LS35M72B02	1SBV 01 3772 R1202	57	LS72M31B02	1SBV 01 4331 R1202	61	LS72M53B02	1SBV 01 4353 R1202	64
LS35M72B11	1SBV 01 3772 R1211	57	LS72M31B11	1SBV 01 4331 R1211	61	LS72M53B11	1SBV 01 4353 R1211	64
LS35M72C11	1SBV 01 3772 R1511	57	LS72M31C11	1SBV 01 4331 R1511	61	LS72M53C11	1SBV 01 4353 R1511	64
LS35M72D11	1SBV 01 3772 R1411	57	LS72M31D11	1SBV 01 4331 R1411	61	LS72M53D11	1SBV 01 4353 R1411	64
LS35M72L02	1SBV 01 3772 R1302	57	LS72M31L02	1SBV 01 4331 R1302	61	LS72M53L02	1SBV 01 4353 R1302	64
LS35M72L20	1SBV 01 3772 R1320	57	LS72M31L20	1SBV 01 4331 R1320	61	LS72M53L20	1SBV 01 4353 R1320	64
LS35M73...			LS72M35...			LS72M61...		
LS35M73B02	1SBV 01 3773 R1202	58	LS72M35B02	1SBV 01 4335 R1202	61	LS72M61B02	1SBV 01 4361 R1202	64
LS35M73B11	1SBV 01 3773 R1211	58	LS72M35B11	1SBV 01 4335 R1211	61	LS72M61B11	1SBV 01 4361 R1211	64
LS35M73C11	1SBV 01 3773 R1511	58	LS72M35C11	1SBV 01 4335 R1511	61	LS72M61C11	1SBV 01 4361 R1511	64
LS35M73D11	1SBV 01 3773 R1411	58	LS72M35D11	1SBV 01 4335 R1411	61	LS72M61D11	1SBV 01 4361 R1411	64
LS35M73L02	1SBV 01 3773 R1302	58	LS72M35L02	1SBV 01 4335 R1302	61	LS72M61L02	1SBV 01 4361 R1302	64
LS35M73L20	1SBV 01 3773 R1320	58	LS72M35L20	1SBV 01 4335 R1320	61	LS72M61L20	1SBV 01 4361 R1320	64
LS35M74...			LS72M38...			LS72M62...		
LS35M74B02	1SBV 01 3774 R1202	58	LS72M38B02	1SBV 01 4338 R1202	61	LS72M62B02	1SBV 01 4362 R1202	65
LS35M74B11	1SBV 01 3774 R1211	58	LS72M38B11	1SBV 01 4338 R1211	61	LS72M62B11	1SBV 01 4362 R1211	65
LS35M74C11	1SBV 01 3774 R1511	58	LS72M38C11	1SBV 01 4338 R1511	61	LS72M62C11	1SBV 01 4362 R1511	65
LS35M74D11	1SBV 01 3774 R1411	58	LS72M38D11	1SBV 01 4338 R1411	61	LS72M62D11	1SBV 01 4362 R1411	65
LS35M74L02	1SBV 01 3774 R1302	58	LS72M38L02	1SBV 01 4338 R1302	61	LS72M62L02	1SBV 01 4362 R1302	65
LS35M74L20	1SBV 01 3774 R1320	58	LS72M38L20	1SBV 01 4338 R1320	61	LS72M62L20	1SBV 01 4362 R1320	65
LS35M78...			LS72M41...			LS72M71...		
LS35M78B02	1SBV 01 3778 R1202	58	LS72M41B02	1SBV 01 4341 R1202	62	LS72M71B02	1SBV 01 4371 R1202	65
LS35M78B11	1SBV 01 3778 R1211	58	LS72M41B11	1SBV 01 4341 R1211	62	LS72M71B11	1SBV 01 4371 R1211	65
LS35M78C11	1SBV 01 3778 R1511	58	LS72M41C11	1SBV 01 4341 R1511	62	LS72M71C11	1SBV 01 4371 R1511	65
LS35M78D11	1SBV 01 3778 R1411	58	LS72M41D11	1SBV 01 4341 R1411	62	LS72M71D11	1SBV 01 4371 R1411	65
LS35M78L02	1SBV 01 3778 R1302	58	LS72M41L02	1SBV 01 4341 R1302	62	LS72M71L02	1SBV 01 4371 R1302	65
LS35M78L20	1SBV 01 3778 R1320	58	LS72M41L20	1SBV 01 4341 R1320	62	LS72M71L20	1SBV 01 4371 R1320	65
LS35M91...			LS72M42...			LS72M72...		
LS35M91B02	1SBV 01 3791 R1202	59	LS72M42B02	1SBV 01 4342 R1202	62	LS72M72B02	1SBV 01 4372 R1202	65
LS35M91B11	1SBV 01 3791 R1211	59	LS72M42B11	1SBV 01 4342 R1211	62	LS72M72B11	1SBV 01 4372 R1211	65
LS35M91C11	1SBV 01 3791 R1511	59	LS72M42C11	1SBV 01 4342 R1511	62	LS72M72C11	1SBV 01 4372 R1511	65
LS35M91D11	1SBV 01 3791 R1411	59	LS72M42D11	1SBV 01 4342 R1411	62	LS72M72D11	1SBV 01 4372 R1411	65
LS35M91L02	1SBV 01 3791 R1302	59	LS72M42L02	1SBV 01 4342 R1302	62	LS72M72L02	1SBV 01 4372 R1302	65
LS35M91L20	1SBV 01 3791 R1320	59	LS72M42L20	1SBV 01 4342 R1320	62	LS72M72L20	1SBV 01 4372 R1320	65

Index

Classification by Type

Type	Order Code	Page	Type	Order Code	Page	Type	Order Code	Page
LS72M73...			LS72P30...			LS72P52...		
LS72M73B02	1SBV 01 4373 R1202	66	LS72P30B02	1SBV 01 1030 R1202	69	LS72P52B02	1SBV 01 1052 R1202	72
LS72M73B11	1SBV 01 4373 R1211	66	LS72P30B11	1SBV 01 1030 R1211	69	LS72P52B11	1SBV 01 1052 R1211	72
LS72M73C11	1SBV 01 4373 R1511	66	LS72P30C11	1SBV 01 1030 R1511	69	LS72P52C11	1SBV 01 1052 R1511	72
LS72M73D11	1SBV 01 4373 R1411	66	LS72P30D11	1SBV 01 1030 R1411	69	LS72P52D11	1SBV 01 1052 R1411	72
LS72M73L02	1SBV 01 4373 R1302	66	LS72P30L02	1SBV 01 1030 R1302	69	LS72P52L02	1SBV 01 1052 R1302	72
LS72M73L20	1SBV 01 4373 R1320	66	LS72P30L20	1SBV 01 1030 R1320	69	LS72P52L20	1SBV 01 1052 R1320	72
LS72M74...			LS72P31...			LS72P53...		
LS72M74B02	1SBV 01 4374 R1202	66	LS72P31B02	1SBV 01 1031 R1202	69	LS72P53B02	1SBV 01 1053 R1202	73
LS72M74B11	1SBV 01 4374 R1211	66	LS72P31B11	1SBV 01 1031 R1211	69	LS72P53B11	1SBV 01 1053 R1211	73
LS72M74C11	1SBV 01 4374 R1511	66	LS72P31C11	1SBV 01 1031 R1511	69	LS72P53C11	1SBV 01 1053 R1511	73
LS72M74D11	1SBV 01 4374 R1411	66	LS72P31D11	1SBV 01 1031 R1411	69	LS72P53D11	1SBV 01 1053 R1411	73
LS72M74L02	1SBV 01 4374 R1302	66	LS72P31L02	1SBV 01 1031 R1302	69	LS72P53L02	1SBV 01 1053 R1302	73
LS72M74L20	1SBV 01 4374 R1320	66	LS72P31L20	1SBV 01 1031 R1320	69	LS72P53L20	1SBV 01 1053 R1320	73
LS72M78...			LS72P35...			LS72P71...		
LS72M78B02	1SBV 01 4378 R1202	66	LS72P35B02	1SBV 01 1035 R1202	70	LS72P71B02	1SBV 01 1071 R1202	73
LS72M78B11	1SBV 01 4378 R1211	66	LS72P35B11	1SBV 01 1035 R1211	70	LS72P71B11	1SBV 01 1071 R1211	73
LS72M78C11	1SBV 01 4378 R1511	66	LS72P35C11	1SBV 01 1035 R1511	70	LS72P71C11	1SBV 01 1071 R1511	73
LS72M78D11	1SBV 01 4378 R1411	66	LS72P35D11	1SBV 01 1035 R1411	70	LS72P71D11	1SBV 01 1071 R1411	73
LS72M78L02	1SBV 01 4378 R1302	66	LS72P35L02	1SBV 01 1035 R1302	70	LS72P71L02	1SBV 01 1071 R1302	73
LS72M78L20	1SBV 01 4378 R1320	66	LS72P35L20	1SBV 01 1035 R1320	70	LS72P71L20	1SBV 01 1071 R1320	73
LS72M91...			LS72P38...			LS72P72...		
LS72M91B02	1SBV 01 4391 R1202	67	LS72P38B02	1SBV 01 1038 R1202	70	LS72P72B02	1SBV 01 1072 R1202	73
LS72M91B11	1SBV 01 4391 R1211	67	LS72P38B11	1SBV 01 1038 R1211	70	LS72P72B11	1SBV 01 1072 R1211	73
LS72M91C11	1SBV 01 4391 R1511	67	LS72P38C11	1SBV 01 1038 R1511	70	LS72P72C11	1SBV 01 1072 R1511	73
LS72M91D11	1SBV 01 4391 R1411	67	LS72P38D11	1SBV 01 1038 R1411	70	LS72P72D11	1SBV 01 1072 R1411	73
LS72M91L02	1SBV 01 4391 R1302	67	LS72P38L02	1SBV 01 1038 R1302	70	LS72P72L02	1SBV 01 1072 R1302	73
LS72M91L20	1SBV 01 4391 R1320	67	LS72P38L20	1SBV 01 1038 R1320	70	LS72P72L20	1SBV 01 1072 R1320	73
LS72M92...			LS72P41...			LS72P73...		
LS72M92B02	1SBV 01 4392 R1202	67	LS72P41B02	1SBV 01 1041 R1202	70	LS72P73B02	1SBV 01 1073 R1202	74
LS72M92B11	1SBV 01 4392 R1211	67	LS72P41B11	1SBV 01 1041 R1211	70	LS72P73B11	1SBV 01 1073 R1211	74
LS72M92C11	1SBV 01 4392 R1511	67	LS72P41C11	1SBV 01 1041 R1511	70	LS72P73C11	1SBV 01 1073 R1511	74
LS72M92D11	1SBV 01 4392 R1411	67	LS72P41D11	1SBV 01 1041 R1411	70	LS72P73D11	1SBV 01 1073 R1411	74
LS72M92L02	1SBV 01 4392 R1302	67	LS72P41L02	1SBV 01 1041 R1302	70	LS72P73L02	1SBV 01 1073 R1302	74
LS72M92L20	1SBV 01 4392 R1320	67	LS72P41L20	1SBV 01 1041 R1320	70	LS72P73L20	1SBV 01 1073 R1320	74
LS72M98...			LS72P42...			LS72P74...		
LS72M98B11-A	1SBV 01 4398 R1211	67	LS72P42B02	1SBV 01 1042 R1202	71	LS72P74B02	1SBV 01 1074 R1202	74
LS72M98D11-A	1SBV 01 4398 R1411	67	LS72P42B11	1SBV 01 1042 R1211	71	LS72P74B11	1SBV 01 1074 R1211	74
LS72M98L02-A	1SBV 01 4398 R1302	67	LS72P42C11	1SBV 01 1042 R1511	71	LS72P74C11	1SBV 01 1074 R1511	74
LS72M98L20-A	1SBV 01 4398 R1320	67	LS72P42D11	1SBV 01 1042 R1411	71	LS72P74D11	1SBV 01 1074 R1411	74
			LS72P42L02	1SBV 01 1042 R1302	71	LS72P74L02	1SBV 01 1074 R1302	74
			LS72P42L20	1SBV 01 1042 R1320	71	LS72P74L20	1SBV 01 1074 R1320	74
LS72P10...			LS72P43...			LS72P78...		
LS72P10B02	1SBV 01 1010 R1202	68	LS72P43B02	1SBV 01 1043 R1202	71	LS72P78B02	1SBV 01 1078 R1202	74
LS72P10B11	1SBV 01 1010 R1211	68	LS72P43B11	1SBV 01 1043 R1211	71	LS72P78B11	1SBV 01 1078 R1211	74
LS72P10C11	1SBV 01 1010 R1511	68	LS72P43C11	1SBV 01 1043 R1511	71	LS72P78C11	1SBV 01 1078 R1511	74
LS72P10D11	1SBV 01 1010 R1411	68	LS72P43D11	1SBV 01 1043 R1411	71	LS72P78D11	1SBV 01 1078 R1411	74
LS72P10L02	1SBV 01 1010 R1302	68	LS72P43L02	1SBV 01 1043 R1302	71	LS72P78L02	1SBV 01 1078 R1302	74
LS72P10L20	1SBV 01 1010 R1320	68	LS72P43L20	1SBV 01 1043 R1320	71	LS72P78L20	1SBV 01 1078 R1320	74
LS72P11...			LS72P45...			LS72P91...		
LS72P11B02	1SBV 01 1011 R1202	68	LS72P45B02	1SBV 01 1045 R1202	71	LS72P91B02	1SBV 01 1091 R1202	75
LS72P11B11	1SBV 01 1011 R1211	68	LS72P45B11	1SBV 01 1045 R1211	71	LS72P91B11	1SBV 01 1091 R1211	75
LS72P11C11	1SBV 01 1011 R1511	68	LS72P45C11	1SBV 01 1045 R1511	71	LS72P91C11	1SBV 01 1091 R1511	75
LS72P11D11	1SBV 01 1011 R1411	68	LS72P45D11	1SBV 01 1045 R1411	71	LS72P91D11	1SBV 01 1091 R1411	75
LS72P11L02	1SBV 01 1011 R1302	68	LS72P45L02	1SBV 01 1045 R1302	71	LS72P91L02	1SBV 01 1091 R1302	75
LS72P11L20	1SBV 01 1011 R1320	68	LS72P45L20	1SBV 01 1045 R1320	71	LS72P91L20	1SBV 01 1091 R1320	75
LS72P12...			LS72P46...			LS72P92...		
LS72P12B02	1SBV 01 1012 R1202	68	LS72P46B02	1SBV 01 1046 R1202	72	LS72P92B02	1SBV 01 1092 R1202	75
LS72P12B11	1SBV 01 1012 R1211	68	LS72P46B11	1SBV 01 1046 R1211	72	LS72P92B11	1SBV 01 1092 R1211	75
LS72P12C11	1SBV 01 1012 R1511	68	LS72P46C11	1SBV 01 1046 R1511	72	LS72P92C11	1SBV 01 1092 R1511	75
LS72P12D11	1SBV 01 1012 R1411	68	LS72P46D11	1SBV 01 1046 R1411	72	LS72P92D11	1SBV 01 1092 R1411	75
LS72P12L02	1SBV 01 1012 R1302	68	LS72P46L02	1SBV 01 1046 R1302	72	LS72P92L02	1SBV 01 1092 R1302	75
LS72P12L20	1SBV 01 1012 R1320	68	LS72P46L20	1SBV 01 1046 R1320	72	LS72P92L20	1SBV 01 1092 R1320	75
LS72P13...			LS72P51...			LS72P98...		
LS72P13B02	1SBV 01 1013 R1202	69	LS72P51B02	1SBV 01 1051 R1202	72	LS72P98B11-A	1SBV 01 1098 R1211	75
LS72P13B11	1SBV 01 1013 R1211	69	LS72P51B11	1SBV 01 1051 R1211	72	LS72P98D11-A	1SBV 01 1098 R1411	75
LS72P13C11	1SBV 01 1013 R1511	69	LS72P51C11	1SBV 01 1051 R1511	72	LS72P98L02-A	1SBV 01 1098 R1302	75
LS72P13D11	1SBV 01 1013 R1411	69	LS72P51D11	1SBV 01 1051 R1411	72	LS72P98L20-A	1SBV 01 1098 R1320	75
LS72P13L02	1SBV 01 1013 R1302	69	LS72P51L02	1SBV 01 1051 R1302	72			
LS72P13L20	1SBV 01 1013 R1320	69	LS72P51L20	1SBV 01 1051 R1320	72			

Index

Classification by Type

Type	Order Code	Page	Type	Order Code	Page	Type	Order Code	Page
LS73M11...			LS73M46...			LS73M78		
LS73M11B02	1SBV 01 5211 R1202	60	LS73M46B02	1SBV 01 5246 R1202	63	LS73M78B02	1SBV 01 5278 R1202	66
LS73M11B11	1SBV 01 5211 R1211	60	LS73M46B11	1SBV 01 5246 R1211	63	LS73M78B11	1SBV 01 5278 R1211	66
LS73M11C11	1SBV 01 5211 R1511	60	LS73M46C11	1SBV 01 5246 R1511	63	LS73M78C11	1SBV 01 5278 R1511	66
LS73M11D11	1SBV 01 5211 R1411	60	LS73M46D11	1SBV 01 5246 R1411	63	LS73M78D11	1SBV 01 5278 R1411	66
LS73M11L02	1SBV 01 5211 R1302	60	LS73M46L02	1SBV 01 5246 R1302	63	LS73M78L02	1SBV 01 5278 R1302	66
LS73M11L20	1SBV 01 5211 R1320	60	LS73M46L20	1SBV 01 5246 R1320	63	LS73M78L20	1SBV 01 5278 R1320	66
LS73M12...			LS73M51...			LS73M91		
LS73M12B02	1SBV 01 5212 R1202	60	LS73M51B02	1SBV 01 5251 R1202	63	LS73M91B02	1SBV 01 5291 R1202	67
LS73M12B11	1SBV 01 5212 R1211	60	LS73M51B11	1SBV 01 5251 R1211	63	LS73M91B11	1SBV 01 5291 R1211	67
LS73M12C11	1SBV 01 5212 R1511	60	LS73M51C11	1SBV 01 5251 R1511	63	LS73M91C11	1SBV 01 5291 R1511	67
LS73M12D11	1SBV 01 5212 R1411	60	LS73M51D11	1SBV 01 5251 R1411	63	LS73M91D11	1SBV 01 5291 R1411	67
LS73M12L02	1SBV 01 5212 R1302	60	LS73M51L02	1SBV 01 5251 R1302	63	LS73M91L02	1SBV 01 5291 R1302	67
LS73M12L20	1SBV 01 5212 R1320	60	LS73M51L20	1SBV 01 5251 R1320	63	LS73M91L20	1SBV 01 5291 R1320	67
LS73M13...			LS73M52...			LS73M92		
LS73M13B02	1SBV 01 5213 R1202	60	LS73M52B02	1SBV 01 5252 R1202	64	LS73M92B02	1SBV 01 5292 R1202	67
LS73M13B11	1SBV 01 5213 R1211	60	LS73M52B11	1SBV 01 5252 R1211	64	LS73M92B11	1SBV 01 5292 R1211	67
LS73M13C11	1SBV 01 5213 R1511	60	LS73M52C11	1SBV 01 5252 R1511	64	LS73M92C11	1SBV 01 5292 R1511	67
LS73M13D11	1SBV 01 5213 R1411	60	LS73M52D11	1SBV 01 5252 R1411	64	LS73M92D11	1SBV 01 5292 R1411	67
LS73M13L02	1SBV 01 5213 R1302	60	LS73M52L02	1SBV 01 5252 R1302	64	LS73M92L02	1SBV 01 5292 R1302	67
LS73M13L20	1SBV 01 5213 R1320	60	LS73M52L20	1SBV 01 5252 R1320	64	LS73M92L20	1SBV 01 5292 R1320	67
LS73M31...			LS73M53...			LS73M98		
LS73M31B02	1SBV 01 5231 R1202	61	LS73M53B02	1SBV 01 5253 R1202	64	LS73M98B11-A	1SBV 01 5298 R1211	67
LS73M31B11	1SBV 01 5231 R1211	61	LS73M53B11	1SBV 01 5253 R1211	64	LS73M98D11-A	1SBV 01 5298 R1411	67
LS73M31C11	1SBV 01 5231 R1511	61	LS73M53C11	1SBV 01 5253 R1511	64	LS73M98L02-A	1SBV 01 5298 R1302	67
LS73M31D11	1SBV 01 5231 R1411	61	LS73M53D11	1SBV 01 5253 R1411	64	LS73M98L20-A	1SBV 01 5298 R1320	67
LS73M31L02	1SBV 01 5231 R1302	61	LS73M53L02	1SBV 01 5253 R1302	64			
LS73M31L20	1SBV 01 5231 R1320	61	LS73M53L20	1SBV 01 5253 R1320	64			
LS73M35...			LS73M61...			LS73P10		
LS73M35B02	1SBV 01 5235 R1202	61	LS73M61B02	1SBV 01 5261 R1202	64	LS73P10B02	1SBV 01 2810 R1202	68
LS73M35B11	1SBV 01 5235 R1211	61	LS73M61B11	1SBV 01 5261 R1211	64	LS73P10B11	1SBV 01 2810 R1211	68
LS73M35C11	1SBV 01 5235 R1511	61	LS73M61C11	1SBV 01 5261 R1511	64	LS73P10C11	1SBV 01 2810 R1511	68
LS73M35L02	1SBV 01 5235 R1302	61	LS73M61D11	1SBV 01 5261 R1411	64	LS73P10D11	1SBV 01 2810 R1411	68
LS73M35L20	1SBV 01 5235 R1320	61	LS73M61L02	1SBV 01 5261 R1302	64	LS73P10L02	1SBV 01 2810 R1302	68
			LS73M61L20	1SBV 01 5261 R1320	64	LS73P10L20	1SBV 01 2810 R1320	68
LS73M38...			LS73M62...			LS73P11		
LS73M38B02	1SBV 01 5238 R1202	61	LS73M62B02	1SBV 01 5262 R1202	65	LS73P11B02	1SBV 01 2811 R1202	68
LS73M38B11	1SBV 01 5238 R1211	61	LS73M62B11	1SBV 01 5262 R1211	65	LS73P11B11	1SBV 01 2811 R1211	68
LS73M38C11	1SBV 01 5238 R1511	61	LS73M62C11	1SBV 01 5262 R1511	65	LS73P11C11	1SBV 01 2811 R1511	68
LS73M38D11	1SBV 01 5238 R1411	61	LS73M62D11	1SBV 01 5262 R1411	65	LS73P11D11	1SBV 01 2811 R1411	68
LS73M38L02	1SBV 01 5238 R1302	61	LS73M62L02	1SBV 01 5262 R1302	65	LS73P11L02	1SBV 01 2811 R1302	68
LS73M38L20	1SBV 01 5238 R1320	61	LS73M62L20	1SBV 01 5262 R1320	65	LS73P11L20	1SBV 01 2811 R1320	68
LS73M41...			LS73M71...			LS73P12		
LS73M41B02	1SBV 01 5241 R1202	62	LS73M71B02	1SBV 01 5271 R1202	65	LS73P12B02	1SBV 01 2812 R1202	68
LS73M41B11	1SBV 01 5241 R1211	62	LS73M71B11	1SBV 01 5271 R1211	65	LS73P12B11	1SBV 01 2812 R1211	68
LS73M41C11	1SBV 01 5241 R1511	62	LS73M71C11	1SBV 01 5271 R1511	65	LS73P12C11	1SBV 01 2812 R1511	68
LS73M41D11	1SBV 01 5241 R1411	62	LS73M71D11	1SBV 01 5271 R1411	65	LS73P12D11	1SBV 01 2812 R1411	68
LS73M41L02	1SBV 01 5241 R1302	62	LS73M71L02	1SBV 01 5271 R1302	65	LS73P12L02	1SBV 01 2812 R1302	68
LS73M41L20	1SBV 01 5241 R1320	62	LS73M71L20	1SBV 01 5271 R1320	65	LS73P12L20	1SBV 01 2812 R1320	68
LS73M42...			LS73M72...			LS73P13		
LS73M42B02	1SBV 01 5242 R1202	62	LS73M72B02	1SBV 01 5272 R1202	65	LS73P13B02	1SBV 01 2813 R1202	69
LS73M42B11	1SBV 01 5242 R1211	62	LS73M72B11	1SBV 01 5272 R1211	65	LS73P13B11	1SBV 01 2813 R1211	69
LS73M42C11	1SBV 01 5242 R1511	62	LS73M72C11	1SBV 01 5272 R1511	65	LS73P13C11	1SBV 01 2813 R1511	69
LS73M42D11	1SBV 01 5242 R1411	62	LS73M72D11	1SBV 01 5272 R1411	65	LS73P13D11	1SBV 01 2813 R1411	69
LS73M42L02	1SBV 01 5242 R1302	62	LS73M72L02	1SBV 01 5272 R1302	65	LS73P13L02	1SBV 01 2813 R1302	69
LS73M42L20	1SBV 01 5242 R1320	62	LS73M72L20	1SBV 01 5272 R1320	65	LS73P13L20	1SBV 01 2813 R1320	69
LS73M43...			LS73M73...			LS73P30		
LS73M43B02	1SBV 01 5243 R1202	62	LS73M73B02	1SBV 01 5273 R1202	66	LS73P30B02	1SBV 01 2830 R1202	69
LS73M43B11	1SBV 01 5243 R1211	62	LS73M73B11	1SBV 01 5273 R1211	66	LS73P30B11	1SBV 01 2830 R1211	69
LS73M43C11	1SBV 01 5243 R1511	62	LS73M73C11	1SBV 01 5273 R1511	66	LS73P30C11	1SBV 01 2830 R1511	69
LS73M43D11	1SBV 01 5243 R1411	62	LS73M73D11	1SBV 01 5273 R1411	66	LS73P30D11	1SBV 01 2830 R1411	69
LS73M43L02	1SBV 01 5243 R1302	62	LS73M73L02	1SBV 01 5273 R1302	66	LS73P30L02	1SBV 01 2830 R1302	69
LS73M43L20	1SBV 01 5243 R1320	62	LS73M73L20	1SBV 01 5273 R1320	66	LS73P30L20	1SBV 01 2830 R1320	69
LS73M45...			LS73M74			LS73P31		
LS73M45B02	1SBV 01 5245 R1202	63	LS73M74B02	1SBV 01 5274 R1202	66	LS73P31B02	1SBV 01 2831 R1202	69
LS73M45B11	1SBV 01 5245 R1211	63	LS73M74B11	1SBV 01 5274 R1211	66	LS73P31B11	1SBV 01 2831 R1211	69
LS73M45C11	1SBV 01 5245 R1511	63	LS73M74C11	1SBV 01 5274 R1511	66	LS73P31C11	1SBV 01 2831 R1511	69
LS73M45D11	1SBV 01 5245 R1411	63	LS73M74D11	1SBV 01 5274 R1411	66	LS73P31D11	1SBV 01 2831 R1411	69
LS73M45L02	1SBV 01 5245 R1302	63	LS73M74L02	1SBV 01 5274 R1302	66	LS73P31L02	1SBV 01 2831 R1302	69
LS73M45L20	1SBV 01 5245 R1320	63	LS73M74L20	1SBV 01 5274 R1320	66	LS73P31L20	1SBV 01 2831 R1320	69

Index

Classification by Type

Type	Order Code	Page	Type	Order Code	Page	Type	Order Code	Page
LS73P35			LS73P71			LS75M13		
LS73P35B02	1SBV 01 2835 R1202	70	LS73P71B02	1SBV 01 2871 R1202	73	LS75M13B02	1SBV 01 5113 R1202	60
LS73P35B11	1SBV 01 2835 R1211	70	LS73P71B11	1SBV 01 2871 R1211	73	LS75M13B11	1SBV 01 5113 R1211	60
LS73P35C11	1SBV 01 2835 R1511	70	LS73P71C11	1SBV 01 2871 R1511	73	LS75M13C11	1SBV 01 5113 R1511	60
LS73P35D11	1SBV 01 2835 R1411	70	LS73P71D11	1SBV 01 2871 R1411	73	LS75M13D11	1SBV 01 5113 R1411	60
LS73P35L02	1SBV 01 2835 R1302	70	LS73P71L02	1SBV 01 2871 R1302	73	LS75M13L02	1SBV 01 5113 R1302	60
LS73P35L20	1SBV 01 2835 R1320	70	LS73P71L20	1SBV 01 2871 R1320	73	LS75M13L20	1SBV 01 5113 R1320	60
LS73P38			LS73P72			LS75M31		
LS73P38B02	1SBV 01 2838 R1202	70	LS73P72B02	1SBV 01 2872 R1202	73	LS75M31B02	1SBV 01 5131 R1202	61
LS73P38B11	1SBV 01 2838 R1211	70	LS73P72B11	1SBV 01 2872 R1211	73	LS75M31B11	1SBV 01 5131 R1211	61
LS73P38C11	1SBV 01 2838 R1511	70	LS73P72C11	1SBV 01 2872 R1511	73	LS75M31C11	1SBV 01 5131 R1511	61
LS73P38D11	1SBV 01 2838 R1411	70	LS73P72D11	1SBV 01 2872 R1411	73	LS75M31D11	1SBV 01 5131 R1411	61
LS73P38L02	1SBV 01 2838 R1302	70	LS73P72L02	1SBV 01 2872 R1302	73	LS75M31L02	1SBV 01 5131 R1302	61
LS73P38L20	1SBV 01 2838 R1320	70	LS73P72L20	1SBV 01 2872 R1320	73	LS75M31L20	1SBV 01 5131 R1320	61
LS73P41			LS73P73			LS75M35		
LS73P41B02	1SBV 01 2841 R1202	70	LS73P73B02	1SBV 01 2873 R1202	74	LS75M35B02	1SBV 01 5135 R1202	61
LS73P41B11	1SBV 01 2841 R1211	70	LS73P73B11	1SBV 01 2873 R1211	74	LS75M35B11	1SBV 01 5135 R1211	61
LS73P41C11	1SBV 01 2841 R1511	70	LS73P73C11	1SBV 01 2873 R1511	74	LS75M35C11	1SBV 01 5135 R1511	61
LS73P41D11	1SBV 01 2841 R1411	70	LS73P73D11	1SBV 01 2873 R1411	74	LS75M35D11	1SBV 01 5135 R1411	61
LS73P41L02	1SBV 01 2841 R1302	70	LS73P73L02	1SBV 01 2873 R1302	74	LS75M35L02	1SBV 01 5135 R1302	61
LS73P41L20	1SBV 01 2841 R1320	70	LS73P73L20	1SBV 01 2873 R1320	74	LS75M35L20	1SBV 01 5135 R1320	61
LS73P42			LS73P74			LS75M38		
LS73P42B02	1SBV 01 2842 R1202	71	LS73P74B02	1SBV 01 2874 R1202	74	LS75M38B02	1SBV 01 5138 R1202	61
LS73P42B11	1SBV 01 2842 R1211	71	LS73P74B11	1SBV 01 2874 R1211	74	LS75M38B11	1SBV 01 5138 R1211	61
LS73P42C11	1SBV 01 2842 R1511	71	LS73P74C11	1SBV 01 2874 R1511	74	LS75M38C11	1SBV 01 5138 R1511	61
LS73P42D11	1SBV 01 2842 R1411	71	LS73P74D11	1SBV 01 2874 R1411	74	LS75M38D11	1SBV 01 5138 R1411	61
LS73P42L02	1SBV 01 2842 R1302	71	LS73P74L02	1SBV 01 2874 R1302	74	LS75M38L02	1SBV 01 5138 R1302	61
LS73P42L20	1SBV 01 2842 R1320	71	LS73P74L20	1SBV 01 2874 R1320	74	LS75M38L20	1SBV 01 5138 R1320	61
LS73P43			LS73P78			LS75M41		
LS73P43B02	1SBV 01 2843 R1202	71	LS73P78B02	1SBV 01 2878 R1202	74	LS75M41B02	1SBV 01 5141 R1202	62
LS73P43B11	1SBV 01 2843 R1211	71	LS73P78B11	1SBV 01 2878 R1211	74	LS75M41B11	1SBV 01 5141 R1211	62
LS73P43C11	1SBV 01 2843 R1511	71	LS73P78C11	1SBV 01 2878 R1511	74	LS75M41C11	1SBV 01 5141 R1511	62
LS73P43D11	1SBV 01 2843 R1411	71	LS73P78D11	1SBV 01 2878 R1411	74	LS75M41D11	1SBV 01 5141 R1411	62
LS73P43L02	1SBV 01 2843 R1302	71	LS73P78L02	1SBV 01 2878 R1302	74	LS75M41L02	1SBV 01 5141 R1302	62
LS73P43L20	1SBV 01 2843 R1320	71	LS73P78L20	1SBV 01 2878 R1320	74	LS75M41L20	1SBV 01 5141 R1320	62
LS73P45			LS73P91			LS75M42		
LS73P45B02	1SBV 01 2845 R1202	71	LS73P91B02	1SBV 01 2891 R1202	75	LS75M42B02	1SBV 01 5142 R1202	62
LS73P45B11	1SBV 01 2845 R1211	71	LS73P91B11	1SBV 01 2891 R1211	75	LS75M42B11	1SBV 01 5142 R1211	62
LS73P45C11	1SBV 01 2845 R1511	71	LS73P91C11	1SBV 01 2891 R1511	75	LS75M42C11	1SBV 01 5142 R1511	62
LS73P45D11	1SBV 01 2845 R1411	71	LS73P91D11	1SBV 01 2891 R1411	75	LS75M42D11	1SBV 01 5142 R1411	62
LS73P45L02	1SBV 01 2845 R1302	71	LS73P91L02	1SBV 01 2891 R1302	75	LS75M42L02	1SBV 01 5142 R1302	62
LS73P45L20	1SBV 01 2845 R1320	71	LS73P91L20	1SBV 01 2891 R1320	75	LS75M42L20	1SBV 01 5142 R1320	62
LS73P46			LS73P92			LS75M43		
LS73P46B02	1SBV 01 2846 R1202	72	LS73P92B02	1SBV 01 2892 R1202	75	LS75M43B02	1SBV 01 5143 R1202	62
LS73P46B11	1SBV 01 2846 R1211	72	LS73P92B11	1SBV 01 2892 R1211	75	LS75M43B11	1SBV 01 5143 R1211	62
LS73P46C11	1SBV 01 2846 R1511	72	LS73P92C11	1SBV 01 2892 R1511	75	LS75M43C11	1SBV 01 5143 R1511	62
LS73P46D11	1SBV 01 2846 R1411	72	LS73P92D11	1SBV 01 2892 R1411	75	LS75M43D11	1SBV 01 5143 R1411	62
LS73P46L02	1SBV 01 2846 R1302	72	LS73P92L02	1SBV 01 2892 R1302	75	LS75M43L02	1SBV 01 5143 R1302	62
LS73P46L20	1SBV 01 2846 R1320	72	LS73P92L20	1SBV 01 2892 R1320	75	LS75M43L20	1SBV 01 5143 R1320	62
LS73P51			LS73P98			LS75M45		
LS73P51B02	1SBV 01 2851 R1202	72	LS73P98B11-A	1SBV 01 2898 R1211	75	LS75M45B02	1SBV 01 5145 R1202	63
LS73P51B11	1SBV 01 2851 R1211	72	LS73P98D11-A	1SBV 01 2898 R1411	75	LS75M45B11	1SBV 01 5145 R1211	63
LS73P51C11	1SBV 01 2851 R1511	72	LS73P98L02-A	1SBV 01 2898 R1302	75	LS75M45C11	1SBV 01 5145 R1511	63
LS73P51D11	1SBV 01 2851 R1411	72	LS73P98L20-A	1SBV 01 2898 R1320	75	LS75M45D11	1SBV 01 5145 R1411	63
LS73P51L02	1SBV 01 2851 R1302	72				LS75M45L02	1SBV 01 5145 R1302	63
LS73P51L20	1SBV 01 2851 R1320	72				LS75M45L20	1SBV 01 5145 R1320	63
LS73P52			LS75M11			LS75M46		
LS73P52B02	1SBV 01 2852 R1202	72	LS75M11B02	1SBV 01 5111 R1202	60	LS75M46B02	1SBV 01 5146 R1202	63
LS73P52B11	1SBV 01 2852 R1211	72	LS75M11B11	1SBV 01 5111 R1211	60	LS75M46B11	1SBV 01 5146 R1211	63
LS73P52C11	1SBV 01 2852 R1511	72	LS75M11C11	1SBV 01 5111 R1511	60	LS75M46C11	1SBV 01 5146 R1511	63
LS73P52D11	1SBV 01 2852 R1411	72	LS75M11D11	1SBV 01 5111 R1411	60	LS75M46D11	1SBV 01 5146 R1411	63
LS73P52L02	1SBV 01 2852 R1302	72	LS75M11L02	1SBV 01 5111 R1302	60	LS75M46L02	1SBV 01 5146 R1302	63
LS73P52L20	1SBV 01 2852 R1320	72	LS75M11L20	1SBV 01 5111 R1320	60	LS75M46L20	1SBV 01 5146 R1320	63
LS73P53			LS75M12			LS75M51		
LS73P53B02	1SBV 01 2853 R1202	73	LS75M12B02	1SBV 01 5112 R1202	60	LS75M51B02	1SBV 01 5151 R1202	63
LS73P53B11	1SBV 01 2853 R1211	73	LS75M12B11	1SBV 01 5112 R1211	60	LS75M51B11	1SBV 01 5151 R1211	63
LS73P53C11	1SBV 01 2853 R1511	73	LS75M12C11	1SBV 01 5112 R1511	60	LS75M51C11	1SBV 01 5151 R1511	63
LS73P53D11	1SBV 01 2853 R1411	73	LS75M12D11	1SBV 01 5112 R1411	60	LS75M51D11	1SBV 01 5151 R1411	63
LS73P53L02	1SBV 01 2853 R1302	73	LS75M12L02	1SBV 01 5112 R1302	60	LS75M51L02	1SBV 01 5151 R1302	63
LS73P53L20	1SBV 01 2853 R1320	73	LS75M12L20	1SBV 01 5112 R1320	60	LS75M51L20	1SBV 01 5151 R1320	63

Index

Classification by Type

Type	Order Code	Page	Type	Order Code	Page	Type	Order Code	Page
LS75M52			LS75M92			LS75P41		
LS75M52B02	1SBV 01 5152 R1202	64	LS75M92B02	1SBV 01 5192 R1202	67	LS75P41B02	1SBV 01 2741 R1202	70
LS75M52B11	1SBV 01 5152 R1211	64	LS75M92B11	1SBV 01 5192 R1211	67	LS75P41B11	1SBV 01 2741 R1211	70
LS75M52C11	1SBV 01 5152 R1511	64	LS75M92C11	1SBV 01 5192 R1511	67	LS75P41C11	1SBV 01 2741 R1511	70
LS75M52D11	1SBV 01 5152 R1411	64	LS75M92D11	1SBV 01 5192 R1411	67	LS75P41D11	1SBV 01 2741 R1411	70
LS75M52L02	1SBV 01 5152 R1302	64	LS75M92L02	1SBV 01 5192 R1302	67	LS75P41L02	1SBV 01 2741 R1302	70
LS75M52L20	1SBV 01 5152 R1320	64	LS75M92L20	1SBV 01 5192 R1320	67	LS75P41L20	1SBV 01 2741 R1320	70
LS75M53			LS75M98			LS75P42		
LS75M53B02	1SBV 01 5153 R1202	64	LS75M98B11-A	1SBV 01 5198 R1211	67	LS75P42B02	1SBV 01 2742 R1202	71
LS75M53B11	1SBV 01 5153 R1211	64	LS75M98D11-A	1SBV 01 5198 R1411	67	LS75P42B11	1SBV 01 2742 R1211	71
LS75M53C11	1SBV 01 5153 R1511	64	LS75M98L02-A	1SBV 01 5198 R1302	67	LS75P42C11	1SBV 01 2742 R1511	71
LS75M53D11	1SBV 01 5153 R1411	64	LS75M98L20-A	1SBV 01 5198 R1320	67	LS75P42D11	1SBV 01 2742 R1411	71
LS75M53L02	1SBV 01 5153 R1302	64	LS75P10			LS75P42L02	1SBV 01 2742 R1302	71
LS75M53L20	1SBV 01 5153 R1320	64	LS75P10B02	1SBV 01 2710 R1202	68	LS75P42L20	1SBV 01 2742 R1320	71
LS75M61			LS75P11			LS75P43		
LS75M61B02	1SBV 01 5161 R1202	64	LS75P11B02	1SBV 01 2711 R1202	68	LS75P43B02	1SBV 01 2743 R1202	71
LS75M61B11	1SBV 01 5161 R1211	64	LS75P11B11	1SBV 01 2711 R1211	68	LS75P43B11	1SBV 01 2743 R1211	71
LS75M61C11	1SBV 01 5161 R1511	64	LS75P11C11	1SBV 01 2711 R1511	68	LS75P43C11	1SBV 01 2743 R1511	71
LS75M61D11	1SBV 01 5161 R1411	64	LS75P11D11	1SBV 01 2711 R1411	68	LS75P43D11	1SBV 01 2743 R1411	71
LS75M61L02	1SBV 01 5161 R1302	64	LS75P11L02	1SBV 01 2711 R1302	68	LS75P43L02	1SBV 01 2743 R1302	71
LS75M61L20	1SBV 01 5161 R1320	64	LS75P11L20	1SBV 01 2711 R1320	68	LS75P43L20	1SBV 01 2743 R1320	71
LS75M62			LS75P12			LS75P45		
LS75M62B02	1SBV 01 5162 R1202	65	LS75P12B02	1SBV 01 2712 R1202	68	LS75P45B02	1SBV 01 2745 R1202	71
LS75M62B11	1SBV 01 5162 R1211	65	LS75P12B11	1SBV 01 2712 R1211	68	LS75P45B11	1SBV 01 2745 R1211	71
LS75M62C11	1SBV 01 5162 R1511	65	LS75P12C11	1SBV 01 2712 R1511	68	LS75P45C11	1SBV 01 2745 R1511	71
LS75M62D11	1SBV 01 5162 R1411	65	LS75P12D11	1SBV 01 2712 R1411	68	LS75P45D11	1SBV 01 2745 R1411	71
LS75M62L02	1SBV 01 5162 R1302	65	LS75P12L02	1SBV 01 2712 R1302	68	LS75P45L02	1SBV 01 2745 R1302	71
LS75M62L20	1SBV 01 5162 R1320	65	LS75P12L20	1SBV 01 2712 R1320	68	LS75P45L20	1SBV 01 2745 R1320	71
LS75M71			LS75P13			LS75P46		
LS75M71B02	1SBV 01 5171 R1202	65	LS75P13B02	1SBV 01 2713 R1202	69	LS75P46B02	1SBV 01 2746 R1202	72
LS75M71B11	1SBV 01 5171 R1211	65	LS75P13B11	1SBV 01 2713 R1211	69	LS75P46B11	1SBV 01 2746 R1211	72
LS75M71C11	1SBV 01 5171 R1511	65	LS75P13C11	1SBV 01 2713 R1511	69	LS75P46C11	1SBV 01 2746 R1511	72
LS75M71D11	1SBV 01 5171 R1411	65	LS75P13D11	1SBV 01 2713 R1411	69	LS75P46D11	1SBV 01 2746 R1411	72
LS75M71L02	1SBV 01 5171 R1302	65	LS75P13L02	1SBV 01 2713 R1302	69	LS75P46L02	1SBV 01 2746 R1302	72
LS75M71L20	1SBV 01 5171 R1320	65	LS75P13L20	1SBV 01 2713 R1320	69	LS75P46L20	1SBV 01 2746 R1320	72
LS75M72			LS75P30			LS75P51		
LS75M72B02	1SBV 01 5172 R1202	65	LS75P30B02	1SBV 01 2730 R1202	69	LS75P51B02	1SBV 01 2751 R1202	72
LS75M72B11	1SBV 01 5172 R1211	65	LS75P30B11	1SBV 01 2730 R1211	69	LS75P51B11	1SBV 01 2751 R1211	72
LS75M72C11	1SBV 01 5172 R1511	65	LS75P30C11	1SBV 01 2730 R1511	69	LS75P51C11	1SBV 01 2751 R1511	72
LS75M72D11	1SBV 01 5172 R1411	65	LS75P30D11	1SBV 01 2730 R1411	69	LS75P51D11	1SBV 01 2751 R1411	72
LS75M72L02	1SBV 01 5172 R1302	65	LS75P30L02	1SBV 01 2730 R1302	69	LS75P51L02	1SBV 01 2751 R1302	72
LS75M72L20	1SBV 01 5172 R1320	65	LS75P30L20	1SBV 01 2730 R1320	69	LS75P51L20	1SBV 01 2751 R1320	72
LS75M73			LS75P31			LS75P52		
LS75M73B02	1SBV 01 5173 R1202	66	LS75P31B02	1SBV 01 2731 R1202	69	LS75P52B02	1SBV 01 2752 R1202	72
LS75M73B11	1SBV 01 5173 R1211	66	LS75P31B11	1SBV 01 2731 R1211	69	LS75P52B11	1SBV 01 2752 R1211	72
LS75M73C11	1SBV 01 5173 R1511	66	LS75P31C11	1SBV 01 2731 R1511	69	LS75P52C11	1SBV 01 2752 R1511	72
LS75M73D11	1SBV 01 5173 R1411	66	LS75P31D11	1SBV 01 2731 R1411	69	LS75P52D11	1SBV 01 2752 R1411	72
LS75M73L02	1SBV 01 5173 R1302	66	LS75P31L02	1SBV 01 2731 R1302	69	LS75P52L02	1SBV 01 2752 R1302	72
LS75M73L20	1SBV 01 5173 R1320	66	LS75P31L20	1SBV 01 2731 R1320	69	LS75P52L20	1SBV 01 2752 R1320	72
LS75M74			LS75P35			LS75P53		
LS75M74B02	1SBV 01 5174 R1202	66	LS75P35B02	1SBV 01 2735 R1202	70	LS75P53B02	1SBV 01 2753 R1202	73
LS75M74B11	1SBV 01 5174 R1211	66	LS75P35B11	1SBV 01 2735 R1211	70	LS75P53B11	1SBV 01 2753 R1211	73
LS75M74C11	1SBV 01 5174 R1511	66	LS75P35C11	1SBV 01 2735 R1511	70	LS75P53C11	1SBV 01 2753 R1511	73
LS75M74D11	1SBV 01 5174 R1411	66	LS75P35D11	1SBV 01 2735 R1411	70	LS75P53D11	1SBV 01 2753 R1411	73
LS75M74L02	1SBV 01 5174 R1302	66	LS75P35L02	1SBV 01 2735 R1302	70	LS75P53L02	1SBV 01 2753 R1302	73
LS75M74L20	1SBV 01 5174 R1320	66	LS75P35L20	1SBV 01 2735 R1320	70	LS75P53L20	1SBV 01 2753 R1320	73
LS75M78			LS75P38			LS75P71		
LS75M78B02	1SBV 01 5178 R1202	66	LS75P38B02	1SBV 01 2738 R1202	70	LS75P71B02	1SBV 01 2771 R1202	73
LS75M78B11	1SBV 01 5178 R1211	66	LS75P38B11	1SBV 01 2738 R1211	70	LS75P71B11	1SBV 01 2771 R1211	73
LS75M78C11	1SBV 01 5178 R1511	66	LS75P38C11	1SBV 01 2738 R1511	70	LS75P71C11	1SBV 01 2771 R1511	73
LS75M78D11	1SBV 01 5178 R1411	66	LS75P38D11	1SBV 01 2738 R1411	70	LS75P71D11	1SBV 01 2771 R1411	73
LS75M78L02	1SBV 01 5178 R1302	66	LS75P38L02	1SBV 01 2738 R1302	70	LS75P71L02	1SBV 01 2771 R1302	73
LS75M78L20	1SBV 01 5178 R1320	66	LS75P38L20	1SBV 01 2738 R1320	70	LS75P71L20	1SBV 01 2771 R1320	73
LS75M91			LS75P72			LS75P72		
LS75M91B02	1SBV 01 5191 R1202	67	LS75P72B02	1SBV 01 2772 R1202	73	LS75P72B02	1SBV 01 2772 R1202	73
LS75M91B11	1SBV 01 5191 R1211	67	LS75P72B11	1SBV 01 2772 R1211	73	LS75P72B11	1SBV 01 2772 R1211	73
LS75M91C11	1SBV 01 5191 R1511	67	LS75P72C11	1SBV 01 2772 R1511	73	LS75P72C11	1SBV 01 2772 R1511	73
LS75M91D11	1SBV 01 5191 R1411	67	LS75P72D11	1SBV 01 2772 R1411	73	LS75P72D11	1SBV 01 2772 R1411	73
LS75M91L02	1SBV 01 5191 R1302	67						
LS75M91L20	1SBV 01 5191 R1320	67						

Index

Classification by Type

Type	Order Code	Page	Type	Order Code	Page	Type	Order Code	Page
LS75P72L02	1SBV 01 2772 R1302	73						
LS75P72L20	1SBV 01 2772 R1320	73						
LS75P73								
LS75P73B02	1SBV 01 2773 R1202	74						
LS75P73B11	1SBV 01 2773 R1211	74						
LS75P73C11	1SBV 01 2773 R1511	74						
LS75P73D11	1SBV 01 2773 R1411	74						
LS75P73L02	1SBV 01 2773 R1302	74						
LS75P73L20	1SBV 01 2773 R1320	74						
LS75P74								
LS75P74B02	1SBV 01 2774 R1202	74						
LS75P74B11	1SBV 01 2774 R1211	74						
LS75P74C11	1SBV 01 2774 R1511	74						
LS75P74D11	1SBV 01 2774 R1411	74						
LS75P74L02	1SBV 01 2774 R1302	74						
LS75P74L20	1SBV 01 2774 R1320	74						
LS75P78								
LS75P78B02	1SBV 01 2778 R1202	74						
LS75P78B11	1SBV 01 2778 R1211	74						
LS75P78C11	1SBV 01 2778 R1511	74						
LS75P78D11	1SBV 01 2778 R1411	74						
LS75P78L02	1SBV 01 2778 R1302	74						
LS75P78L20	1SBV 01 2778 R1320	74						
LS75P91								
LS75P91B02	1SBV 01 2791 R1202	75						
LS75P91B11	1SBV 01 2791 R1211	75						
LS75P91C11	1SBV 01 2791 R1511	75						
LS75P91D11	1SBV 01 2791 R1411	75						
LS75P91L02	1SBV 01 2791 R1302	75						
LS75P91L20	1SBV 01 2791 R1320	75						
LS75P92								
LS75P92B02	1SBV 01 2792 R1202	75						
LS75P92B11	1SBV 01 2792 R1211	75						
LS75P92C11	1SBV 01 2792 R1511	75						
LS75P92D11	1SBV 01 2792 R1411	75						
LS75P92L02	1SBV 01 2792 R1302	75						
LS75P92L20	1SBV 01 2792 R1320	75						
LS75P98								
LS75P98B11-A	1SBV 01 2798 R1211	75						
LS75P98D11-A	1SBV 01 2798 R1411	75						
LS75P98L02-A	1SBV 01 2798 R1302	75						
LS75P98L20-A	1SBV 01 2798 R1320	75						

Index

Classification by Order Code

Order Code	Type	Page	Order Code	Type	Page	Order Code	Type	Page
1SBV 01 101...			1SBV 01 1046 R1411	LS72P46D11	72	1SBV 01 1912 R1211	LS32M12B11	52
1SBV 01 1010 R1202	LS72P10B02	68	1SBV 01 1046 R1511	LS72P46C11	72	1SBV 01 1912 R1302	LS32M12L02	52
1SBV 01 1010 R1211	LS72P10B11	68				1SBV 01 1912 R1320	LS32M12L20	52
1SBV 01 1010 R1302	LS72P10L02	68	1SBV 01 105...			1SBV 01 1912 R1411	LS32M12D11	52
1SBV 01 1010 R1320	LS72P10L20	68	1SBV 01 1051 R1202	LS72P51B02	72	1SBV 01 1912 R1511	LS32M12C11	52
1SBV 01 1010 R1411	LS72P10D11	68	1SBV 01 1051 R1211	LS72P51B11	72	1SBV 01 1913 R1202	LS32M13B02	52
1SBV 01 1010 R1511	LS72P10C11	68	1SBV 01 1051 R1302	LS72P51L02	72	1SBV 01 1913 R1211	LS32M13B11	52
1SBV 01 1011 R1202	LS72P11B02	68	1SBV 01 1051 R1320	LS72P51L20	72	1SBV 01 1913 R1302	LS32M13L02	52
1SBV 01 1011 R1211	LS72P11B11	68	1SBV 01 1051 R1411	LS72P51D11	72	1SBV 01 1913 R1320	LS32M13L20	52
1SBV 01 1011 R1302	LS72P11L02	68	1SBV 01 1051 R1511	LS72P51C11	72	1SBV 01 1913 R1411	LS32M13D11	52
1SBV 01 1011 R1320	LS72P11L20	68	1SBV 01 1052 R1202	LS72P52B02	72	1SBV 01 1913 R1511	LS32M13C11	52
1SBV 01 1011 R1411	LS72P11D11	68	1SBV 01 1052 R1211	LS72P52B11	72	1SBV 01 1914 R1202	LS32M14B02	53
1SBV 01 1011 R1511	LS72P11C11	68	1SBV 01 1052 R1302	LS72P52L02	72	1SBV 01 1914 R1211	LS32M14B11	53
1SBV 01 1012 R1202	LS72P12B02	68	1SBV 01 1052 R1411	LS72P52D11	72	1SBV 01 1914 R1302	LS32M14L02	53
1SBV 01 1012 R1211	LS72P12B11	68	1SBV 01 1052 R1511	LS72P52C11	72	1SBV 01 1914 R1320	LS32M14L20	53
1SBV 01 1012 R1302	LS72P12L02	68	1SBV 01 1053 R1202	LS72P53B02	73	1SBV 01 1914 R1411	LS32M14D11	53
1SBV 01 1012 R1320	LS72P12L20	68	1SBV 01 1053 R1211	LS72P53B11	73	1SBV 01 1914 R1511	LS32M14C11	53
1SBV 01 1012 R1411	LS72P12D11	68	1SBV 01 1053 R1302	LS72P53L02	73			
1SBV 01 1012 R1511	LS72P12C11	68	1SBV 01 1053 R1320	LS72P53D11	73	1SBV 01 193...		
1SBV 01 1013 R1202	LS72P13B02	69	1SBV 01 1053 R1411	LS72P53C11	73	1SBV 01 1931 R1202	LS32M31B02	53
1SBV 01 1013 R1211	LS72P13B11	69	1SBV 01 1053 R1511			1SBV 01 1931 R1211	LS32M31B11	53
1SBV 01 1013 R1302	LS72P13L02	69				1SBV 01 1931 R1302	LS32M31L02	53
1SBV 01 1013 R1320	LS72P13L20	69	1SBV 01 107...			1SBV 01 1931 R1320	LS32M31L20	53
1SBV 01 1013 R1411	LS72P13D11	69	1SBV 01 1071 R1202	LS72P71B02	73	1SBV 01 1931 R1411	LS32M31D11	53
1SBV 01 1013 R1511	LS72P13C11	69	1SBV 01 1071 R1211	LS72P71B11	73	1SBV 01 1931 R1511	LS32M31C11	53
			1SBV 01 1071 R1302	LS72P71L02	73	1SBV 01 1932 R1202	LS32M32B02	53
1SBV 01 103...			1SBV 01 1071 R1320	LS72P71L20	73	1SBV 01 1932 R1211	LS32M32B11	53
1SBV 01 1030 R1202	LS72P30B02	69	1SBV 01 1071 R1411	LS72P71D11	73	1SBV 01 1932 R1302	LS32M32L02	53
1SBV 01 1030 R1211	LS72P30B11	69	1SBV 01 1071 R1511	LS72P71C11	73	1SBV 01 1932 R1320	LS32M32L20	53
1SBV 01 1030 R1302	LS72P30L02	69	1SBV 01 1072 R1202	LS72P72B02	73	1SBV 01 1932 R1411	LS32M32D11	53
1SBV 01 1030 R1320	LS72P30L20	69	1SBV 01 1072 R1211	LS72P72B11	73	1SBV 01 1932 R1511	LS32M32C11	53
1SBV 01 1030 R1411	LS72P30D11	69	1SBV 01 1072 R1302	LS72P72L02	73	1SBV 01 1938 R1202	LS32M38B02	54
1SBV 01 1030 R1511	LS72P30C11	69	1SBV 01 1072 R1320	LS72P72L20	73	1SBV 01 1938 R1211	LS32M38B11	54
1SBV 01 1031 R1202	LS72P31B02	69	1SBV 01 1072 R1411	LS72P72D11	73	1SBV 01 1938 R1302	LS32M38L02	54
1SBV 01 1031 R1211	LS72P31B11	69	1SBV 01 1072 R1511	LS72P72C11	73	1SBV 01 1938 R1320	LS32M38L20	54
1SBV 01 1031 R1302	LS72P31L02	69	1SBV 01 1073 R1202	LS72P73B02	74	1SBV 01 1938 R1411	LS32M38D11	54
1SBV 01 1031 R1320	LS72P31L20	69	1SBV 01 1073 R1211	LS72P73B11	74	1SBV 01 1938 R1511	LS32M38C11	54
1SBV 01 1031 R1411	LS72P31D11	69	1SBV 01 1073 R1302	LS72P73L02	74			
1SBV 01 1031 R1511	LS72P31C11	69	1SBV 01 1073 R1320	LS72P73L20	74	1SBV 01 194...		
1SBV 01 1035 R1202	LS72P35B02	70	1SBV 01 1073 R1411	LS72P73D11	74	1SBV 01 1941 R1202	LS32M41B02	54
1SBV 01 1035 R1211	LS72P35B11	70	1SBV 01 1073 R1511	LS72P73C11	74	1SBV 01 1941 R1211	LS32M41B11	54
1SBV 01 1035 R1302	LS72P35L02	70	1SBV 01 1074 R1202	LS72P74B02	74	1SBV 01 1941 R1302	LS32M41L02	54
1SBV 01 1035 R1320	LS72P35L20	70	1SBV 01 1074 R1211	LS72P74B11	74	1SBV 01 1941 R1320	LS32M41L20	54
1SBV 01 1035 R1411	LS72P35D11	70	1SBV 01 1074 R1302	LS72P74L02	74	1SBV 01 1941 R1411	LS32M41D11	54
1SBV 01 1035 R1511	LS72P35C11	70	1SBV 01 1074 R1320	LS72P74L20	74	1SBV 01 1941 R1511	LS32M41C11	54
1SBV 01 1038 R1202	LS72P38B02	70	1SBV 01 1074 R1411	LS72P74D11	74	1SBV 01 1942 R1202	LS32M42B02	54
1SBV 01 1038 R1211	LS72P38B11	70	1SBV 01 1074 R1511	LS72P74C11	74	1SBV 01 1942 R1211	LS32M42B11	54
1SBV 01 1038 R1302	LS72P38L02	70	1SBV 01 1078 R1202	LS72P78B02	74	1SBV 01 1942 R1302	LS32M42L02	54
1SBV 01 1038 R1320	LS72P38L20	70	1SBV 01 1078 R1211	LS72P78B11	74	1SBV 01 1942 R1320	LS32M42L20	54
1SBV 01 1038 R1411	LS72P38D11	70	1SBV 01 1078 R1302	LS72P78L02	74	1SBV 01 1942 R1411	LS32M42D11	54
1SBV 01 1038 R1511	LS72P38C11	70	1SBV 01 1078 R1320	LS72P78L20	74	1SBV 01 1942 R1511	LS32M42C11	54
			1SBV 01 1078 R1411	LS72P78D11	74	1SBV 01 1943 R1202	LS32M43B02	55
1SBV 01 104...			1SBV 01 1078 R1511	LS72P78C11	74	1SBV 01 1943 R1211	LS32M43B11	55
1SBV 01 1041 R1202	LS72P41B02	70				1SBV 01 1943 R1302	LS32M43L02	55
1SBV 01 1041 R1211	LS72P41B11	70	1SBV 01 109...			1SBV 01 1943 R1320	LS32M43L20	55
1SBV 01 1041 R1302	LS72P41L02	70	1SBV 01 1091 R1202	LS72P91B02	75	1SBV 01 1943 R1411	LS32M43D11	55
1SBV 01 1041 R1320	LS72P41L20	70	1SBV 01 1091 R1211	LS72P91B11	75	1SBV 01 1943 R1511	LS32M43C11	55
1SBV 01 1041 R1411	LS72P41D11	70	1SBV 01 1091 R1302	LS72P91L02	75	1SBV 01 1945 R1202	LS32M45B02	55
1SBV 01 1041 R1511	LS72P41C11	70	1SBV 01 1091 R1320	LS72P91L20	75	1SBV 01 1945 R1211	LS32M45B11	55
1SBV 01 1042 R1202	LS72P42B02	71	1SBV 01 1091 R1411	LS72P91D11	75	1SBV 01 1945 R1302	LS32M45L02	55
1SBV 01 1042 R1211	LS72P42B11	71	1SBV 01 1091 R1511	LS72P91C11	75	1SBV 01 1945 R1320	LS32M45L20	55
1SBV 01 1042 R1302	LS72P42L02	71	1SBV 01 1092 R1202	LS72P92B02	75	1SBV 01 1945 R1411	LS32M45D11	55
1SBV 01 1042 R1320	LS72P42L20	71	1SBV 01 1092 R1211	LS72P92B11	75	1SBV 01 1945 R1511	LS32M45C11	55
1SBV 01 1042 R1411	LS72P42D11	71	1SBV 01 1092 R1302	LS72P92L02	75	1SBV 01 1946 R1202	LS32M46B02	55
1SBV 01 1042 R1511	LS72P42C11	71	1SBV 01 1092 R1320	LS72P92L20	75	1SBV 01 1946 R1211	LS32M46B11	55
1SBV 01 1043 R1202	LS72P43B02	71	1SBV 01 1092 R1411	LS72P92D11	75	1SBV 01 1946 R1302	LS32M46L02	55
1SBV 01 1043 R1211	LS72P43B11	71	1SBV 01 1092 R1511	LS72P92C11	75	1SBV 01 1946 R1320	LS32M46L20	55
1SBV 01 1043 R1302	LS72P43L02	71	1SBV 01 1098 R1211	LS72P98B11-A	75	1SBV 01 1946 R1411	LS32M46D11	55
1SBV 01 1043 R1320	LS72P43L20	71	1SBV 01 1098 R1302	LS72P98L02-A	75	1SBV 01 1946 R1511	LS32M46C11	55
1SBV 01 1043 R1411	LS72P43D11	71	1SBV 01 1098 R1320	LS72P98L20-A	75			
1SBV 01 1043 R1511	LS72P43C11	71	1SBV 01 1098 R1411	LS72P98D11-A	75	1SBV 01 195...		
1SBV 01 1045 R1202	LS72P45B02	71				1SBV 01 1951 R1202	LS32M51B02	56
1SBV 01 1045 R1211	LS72P45B11	71	1SBV 01 191...			1SBV 01 1951 R1211	LS32M51B11	56
1SBV 01 1045 R1302	LS72P45L02	71	1SBV 01 1911 R1202	LS32M11B02	52	1SBV 01 1951 R1302	LS32M51L02	56
1SBV 01 1045 R1320	LS72P45L20	71	1SBV 01 1911 R1211	LS32M11B11	52	1SBV 01 1951 R1320	LS32M51L20	56
1SBV 01 1045 R1411	LS72P45D11	71	1SBV 01 1911 R1302	LS32M11L02	52	1SBV 01 1951 R1411	LS32M51D11	56
1SBV 01 1045 R1511	LS72P45C11	71	1SBV 01 1911 R1320	LS32M11L20	52	1SBV 01 1951 R1511	LS32M51C11	56
1SBV 01 1046 R1202	LS72P46B02	72	1SBV 01 1911 R1411	LS32M11D11	52	1SBV 01 1952 R1202	LS32M52B02	56
1SBV 01 1046 R1211	LS72P46B11	72	1SBV 01 1911 R1511	LS32M11C11	52	1SBV 01 1952 R1211	LS32M52B11	56
1SBV 01 1046 R1302	LS72P46L02	72	1SBV 01 1912 R1202	LS32M12B02	52	1SBV 01 1952 R1302	LS32M52L02	56
1SBV 01 1046 R1320	LS72P46L20	72				1SBV 01 1952 R1320	LS32M52L20	56

Index

Classification by Order Code

Order Code	Type	Page	Order Code	Type	Page	Order Code	Type	Page
1SBV 01 283...			1SBV 01 2871 R1302	LS73P71L02	73	1SBV 01 3732 R1211	LS35M32B11	53
1SBV 01 2830 R1202	LS73P30B02	69	1SBV 01 2871 R1320	LS73P71L20	73	1SBV 01 3732 R1302	LS35M32L02	53
1SBV 01 2830 R1211	LS73P30B11	69	1SBV 01 2871 R1411	LS73P71D11	73	1SBV 01 3732 R1320	LS35M32L20	53
1SBV 01 2830 R1302	LS73P30L02	69	1SBV 01 2871 R1511	LS73P71C11	73	1SBV 01 3732 R1411	LS35M32D11	53
1SBV 01 2830 R1320	LS73P30L20	69	1SBV 01 2872 R1202	LS73P72B02	73	1SBV 01 3732 R1511	LS35M32C11	53
1SBV 01 2830 R1411	LS73P30D11	69	1SBV 01 2872 R1211	LS73P72B11	73	1SBV 01 3738 R1202	LS35M38B02	54
1SBV 01 2830 R1511	LS73P30C11	69	1SBV 01 2872 R1302	LS73P72L02	73	1SBV 01 3738 R1211	LS35M38B11	54
1SBV 01 2831 R1202	LS73P31B02	69	1SBV 01 2872 R1320	LS73P72L20	73	1SBV 01 3738 R1302	LS35M38L02	54
1SBV 01 2831 R1211	LS73P31B11	69	1SBV 01 2872 R1411	LS73P72D11	73	1SBV 01 3738 R1320	LS35M38L20	54
1SBV 01 2831 R1302	LS73P31L02	69	1SBV 01 2872 R1511	LS73P72C11	73	1SBV 01 3738 R1411	LS35M38D11	54
1SBV 01 2831 R1320	LS73P31L20	69	1SBV 01 2873 R1202	LS73P73B02	74	1SBV 01 3738 R1511	LS35M38C11	54
1SBV 01 2831 R1411	LS73P31D11	69	1SBV 01 2873 R1211	LS73P73B11	74			
1SBV 01 2831 R1511	LS73P31C11	69	1SBV 01 2873 R1302	LS73P73L02	74	1SBV 01 374...		
1SBV 01 2835 R1202	LS73P35B02	70	1SBV 01 2873 R1320	LS73P73L20	74	1SBV 01 3741 R1202	LS35M41B02	54
1SBV 01 2835 R1211	LS73P35B11	70	1SBV 01 2873 R1411	LS73P73D11	74	1SBV 01 3741 R1211	LS35M41B11	54
1SBV 01 2835 R1302	LS73P35L02	70	1SBV 01 2873 R1511	LS73P73C11	74	1SBV 01 3741 R1302	LS35M41L02	54
1SBV 01 2835 R1320	LS73P35L20	70	1SBV 01 2874 R1202	LS73P74B02	74	1SBV 01 3741 R1320	LS35M41L20	54
1SBV 01 2835 R1411	LS73P35D11	70	1SBV 01 2874 R1211	LS73P74B11	74	1SBV 01 3741 R1411	LS35M41D11	54
1SBV 01 2835 R1511	LS73P35C11	70	1SBV 01 2874 R1302	LS73P74L02	74	1SBV 01 3741 R1511	LS35M41C11	54
1SBV 01 2838 R1202	LS73P38B02	70	1SBV 01 2874 R1320	LS73P74L20	74	1SBV 01 3742 R1202	LS35M42B02	54
1SBV 01 2838 R1211	LS73P38B11	70	1SBV 01 2874 R1411	LS73P74D11	74	1SBV 01 3742 R1211	LS35M42B11	54
1SBV 01 2838 R1302	LS73P38L02	70	1SBV 01 2874 R1511	LS73P74C11	74	1SBV 01 3742 R1302	LS35M42L02	54
1SBV 01 2838 R1320	LS73P38L20	70	1SBV 01 2878 R1202	LS73P78B02	74	1SBV 01 3742 R1320	LS35M42L20	54
1SBV 01 2838 R1411	LS73P38D11	70	1SBV 01 2878 R1211	LS73P78B11	74	1SBV 01 3742 R1411	LS35M42D11	54
1SBV 01 2838 R1511	LS73P38C11	70	1SBV 01 2878 R1302	LS73P78L02	74	1SBV 01 3742 R1511	LS35M42C11	54
			1SBV 01 2878 R1320	LS73P78L20	74	1SBV 01 3743 R1202	LS35M43B02	55
			1SBV 01 2878 R1411	LS73P78D11	74	1SBV 01 3743 R1211	LS35M43B11	55
			1SBV 01 2878 R1511	LS73P78C11	74	1SBV 01 3743 R1302	LS35M43L02	55
						1SBV 01 3743 R1320	LS35M43L20	55
1SBV 01 284...			1SBV 01 289...			1SBV 01 3743 R1411	LS35M43D11	55
1SBV 01 2841 R1202	LS73P41B02	70	1SBV 01 2891 R1202	LS73P91B02	75	1SBV 01 3743 R1511	LS35M43C11	55
1SBV 01 2841 R1211	LS73P41B11	70	1SBV 01 2891 R1211	LS73P91B11	75	1SBV 01 3745 R1202	LS35M45B02	55
1SBV 01 2841 R1302	LS73P41L02	70	1SBV 01 2891 R1302	LS73P91L02	75	1SBV 01 3745 R1211	LS35M45B11	55
1SBV 01 2841 R1320	LS73P41L20	70	1SBV 01 2891 R1320	LS73P91L20	75	1SBV 01 3745 R1302	LS35M45L02	55
1SBV 01 2841 R1411	LS73P41D11	70	1SBV 01 2891 R1411	LS73P91D11	75	1SBV 01 3745 R1320	LS35M45L20	55
1SBV 01 2841 R1511	LS73P41C11	70	1SBV 01 2891 R1511	LS73P91C11	75	1SBV 01 3745 R1411	LS35M45D11	55
1SBV 01 2842 R1202	LS73P42B02	71	1SBV 01 2892 R1202	LS73P92B02	75	1SBV 01 3745 R1511	LS35M45C11	55
1SBV 01 2842 R1211	LS73P42B11	71	1SBV 01 2892 R1211	LS73P92B11	75	1SBV 01 3746 R1202	LS35M46B02	55
1SBV 01 2842 R1302	LS73P42L02	71	1SBV 01 2892 R1302	LS73P92L02	75	1SBV 01 3746 R1211	LS35M46B11	55
1SBV 01 2842 R1320	LS73P42L20	71	1SBV 01 2892 R1320	LS73P92L20	75	1SBV 01 3746 R1302	LS35M46L02	55
1SBV 01 2842 R1411	LS73P42D11	71	1SBV 01 2892 R1411	LS73P92D11	75	1SBV 01 3746 R1320	LS35M46L20	55
1SBV 01 2842 R1511	LS73P42C11	71	1SBV 01 2892 R1511	LS73P92C11	75	1SBV 01 3746 R1411	LS35M46D11	55
1SBV 01 2843 R1202	LS73P43B02	71	1SBV 01 2898 R1211	LS73P98B11-A	75	1SBV 01 3746 R1511	LS35M46C11	55
1SBV 01 2843 R1211	LS73P43B11	71	1SBV 01 2898 R1302	LS73P98L02-A	75			
1SBV 01 2843 R1302	LS73P43L02	71	1SBV 01 2898 R1320	LS73P98L20-A	75	1SBV 01 375...		
1SBV 01 2843 R1320	LS73P43L20	71	1SBV 01 2898 R1411	LS73P98D11-A	75	1SBV 01 3751 R1202	LS35M51B02	56
1SBV 01 2843 R1411	LS73P43D11	71				1SBV 01 3751 R1211	LS35M51B11	56
1SBV 01 2843 R1511	LS73P43C11	71	1SBV 01 371...			1SBV 01 3751 R1302	LS35M51L02	56
1SBV 01 2845 R1202	LS73P45B02	71	1SBV 01 3711 R1202	LS35M11B02	52	1SBV 01 3751 R1320	LS35M51L20	56
1SBV 01 2845 R1211	LS73P45B11	71	1SBV 01 3711 R1211	LS35M11B11	52	1SBV 01 3751 R1411	LS35M51D11	56
1SBV 01 2845 R1302	LS73P45L02	71	1SBV 01 3711 R1302	LS35M11L02	52	1SBV 01 3751 R1511	LS35M51C11	56
1SBV 01 2845 R1320	LS73P45L20	71	1SBV 01 3711 R1320	LS35M11L20	52	1SBV 01 3752 R1202	LS35M52B02	56
1SBV 01 2845 R1411	LS73P45D11	71	1SBV 01 3711 R1411	LS35M11D11	52	1SBV 01 3752 R1211	LS35M52B11	56
1SBV 01 2845 R1511	LS73P45C11	71	1SBV 01 3711 R1511	LS35M11C11	52	1SBV 01 3752 R1302	LS35M52L02	56
1SBV 01 2846 R1202	LS73P46B02	72	1SBV 01 3712 R1202	LS35M12B02	52	1SBV 01 3752 R1320	LS35M52L20	56
1SBV 01 2846 R1211	LS73P46B11	72	1SBV 01 3712 R1211	LS35M12B11	52	1SBV 01 3752 R1411	LS35M52D11	56
1SBV 01 2846 R1302	LS73P46L02	72	1SBV 01 3712 R1302	LS35M12L02	52	1SBV 01 3752 R1511	LS35M52C11	56
1SBV 01 2846 R1320	LS73P46L20	72	1SBV 01 3712 R1411	LS35M12L20	52	1SBV 01 3753 R1202	LS35M53B02	56
1SBV 01 2846 R1411	LS73P46D11	72	1SBV 01 3712 R1511	LS35M12D11	52	1SBV 01 3753 R1211	LS35M53B11	56
1SBV 01 2846 R1511	LS73P46C11	72	1SBV 01 3712 R1302	LS35M12C11	52	1SBV 01 3753 R1302	LS35M53L02	56
			1SBV 01 3713 R1202	LS35M13B02	52	1SBV 01 3753 R1320	LS35M53L20	56
1SBV 01 285...			1SBV 01 3713 R1211	LS35M13B11	52	1SBV 01 3753 R1411	LS35M53D11	56
1SBV 01 2851 R1202	LS73P51B02	72	1SBV 01 3713 R1302	LS35M13L02	52	1SBV 01 3753 R1511	LS35M53C11	56
1SBV 01 2851 R1211	LS73P51B11	72	1SBV 01 3713 R1320	LS35M13L20	52	1SBV 01 3755 R1202	LS35M55B02	57
1SBV 01 2851 R1302	LS73P51L02	72	1SBV 01 3713 R1411	LS35M13D11	52	1SBV 01 3755 R1211	LS35M55B11	57
1SBV 01 2851 R1320	LS73P51L20	72	1SBV 01 3713 R1511	LS35M13C11	52	1SBV 01 3755 R1302	LS35M55L02	57
1SBV 01 2851 R1411	LS73P51D11	72	1SBV 01 3714 R1202	LS35M14B02	53	1SBV 01 3755 R1320	LS35M55L20	57
1SBV 01 2851 R1511	LS73P51C11	72	1SBV 01 3714 R1211	LS35M14B11	53	1SBV 01 3755 R1411	LS35M55D11	57
1SBV 01 2852 R1202	LS73P52B02	72	1SBV 01 3714 R1211	LS35M14B11	53	1SBV 01 3755 R1511	LS35M55C11	57
1SBV 01 2852 R1211	LS73P52B11	72	1SBV 01 3714 R1302	LS35M14L02	53			
1SBV 01 2852 R1302	LS73P52L02	72	1SBV 01 3714 R1411	LS35M14D11	53	1SBV 01 377...		
1SBV 01 2852 R1320	LS73P52L20	72	1SBV 01 3714 R1511	LS35M14C11	53	1SBV 01 3771 R1202	LS35M71B02	57
1SBV 01 2852 R1411	LS73P52D11	72				1SBV 01 3771 R1211	LS35M71B11	57
1SBV 01 2852 R1511	LS73P52C11	72	1SBV 01 373...			1SBV 01 3771 R1302	LS35M71L02	57
1SBV 01 2853 R1202	LS73P53B02	73	1SBV 01 3731 R1202	LS35M31B02	53	1SBV 01 3771 R1320	LS35M71L20	57
1SBV 01 2853 R1211	LS73P53B11	73	1SBV 01 3731 R1211	LS35M31B11	53	1SBV 01 3771 R1411	LS35M71D11	57
1SBV 01 2853 R1302	LS73P53L02	73	1SBV 01 3731 R1302	LS35M31L02	53	1SBV 01 3771 R1511	LS35M71C11	57
1SBV 01 2853 R1320	LS73P53L20	73	1SBV 01 3731 R1320	LS35M31L20	53	1SBV 01 3772 R1202	LS35M72B02	57
1SBV 01 2853 R1411	LS73P53D11	73	1SBV 01 3731 R1411	LS35M31D11	53	1SBV 01 3772 R1211	LS35M72B11	57
1SBV 01 2853 R1511	LS73P53C11	73	1SBV 01 3731 R1511	LS35M31C11	53	1SBV 01 3772 R1302	LS35M72L02	57
			1SBV 01 3732 R1202	LS35M32B02	53	1SBV 01 3772 R1320	LS35M72L20	57
1SBV 01 287...								
1SBV 01 2871 R1202	LS73P71B02	73						
1SBV 01 2871 R1211	LS73P71B11	73						

Index

Classification by Order Code

Order Code	Type	Page	Order Code	Type	Page	Order Code	Type	Page
1SBV 01 3772 R1411	LS35M72D11	57	1SBV 01 3838 R1320	LS33M38L20	54	1SBV 01 3874 R1202	LS33M74B02	58
1SBV 01 3772 R1511	LS35M72C11	57	1SBV 01 3838 R1411	LS33M38D11	54	1SBV 01 3874 R1211	LS33M74B11	58
1SBV 01 3773 R1202	LS35M73B02	58	1SBV 01 3838 R1511	LS33M38C11	54	1SBV 01 3874 R1302	LS33M74L02	58
1SBV 01 3773 R1211	LS35M73B11	58				1SBV 01 3874 R1320	LS33M74L20	58
1SBV 01 3773 R1302	LS35M73L02	58	1SBV 01 384...			1SBV 01 3874 R1411	LS33M74D11	58
1SBV 01 3773 R1320	LS35M73L20	58	1SBV 01 3841 R1202	LS33M41B02	54	1SBV 01 3874 R1511	LS33M74C11	58
1SBV 01 3773 R1411	LS35M73D11	58	1SBV 01 3841 R1211	LS33M41B11	54	1SBV 01 3878 R1202	LS33M78B02	58
1SBV 01 3773 R1511	LS35M73C11	58	1SBV 01 3841 R1302	LS33M41L02	54	1SBV 01 3878 R1211	LS33M78B11	58
1SBV 01 3774 R1202	LS35M74B02	58	1SBV 01 3841 R1320	LS33M41L20	54	1SBV 01 3878 R1302	LS33M78L02	58
1SBV 01 3774 R1211	LS35M74B11	58	1SBV 01 3841 R1411	LS33M41D11	54	1SBV 01 3878 R1320	LS33M78L20	58
1SBV 01 3774 R1302	LS35M74L02	58	1SBV 01 3841 R1511	LS33M41C11	54	1SBV 01 3878 R1411	LS33M78D11	58
1SBV 01 3774 R1320	LS35M74L20	58	1SBV 01 3842 R1202	LS33M42B02	54	1SBV 01 3878 R1511	LS33M78C11	58
1SBV 01 3774 R1411	LS35M74D11	58	1SBV 01 3842 R1211	LS33M42B11	54			
1SBV 01 3774 R1511	LS35M74C11	58	1SBV 01 3842 R1302	LS33M42L02	54	1SBV 01 389...		
1SBV 01 3778 R1202	LS35M78B02	58	1SBV 01 3842 R1320	LS33M42L20	54	1SBV 01 3891 R1202	LS33M91B02	59
1SBV 01 3778 R1211	LS35M78B11	58	1SBV 01 3842 R1411	LS33M42D11	54	1SBV 01 3891 R1211	LS33M91B11	59
1SBV 01 3778 R1302	LS35M78L02	58	1SBV 01 3842 R1511	LS33M42C11	54	1SBV 01 3891 R1302	LS33M91L02	59
1SBV 01 3778 R1320	LS35M78L20	58	1SBV 01 3843 R1202	LS33M43B02	55	1SBV 01 3891 R1320	LS33M91L20	59
1SBV 01 3778 R1411	LS35M78D11	58	1SBV 01 3843 R1211	LS33M43B11	55	1SBV 01 3891 R1411	LS33M91D11	59
1SBV 01 3778 R1511	LS35M78C11	58	1SBV 01 3843 R1302	LS33M43L02	55	1SBV 01 3891 R1511	LS33M91C11	59
1SBV 01 379...			1SBV 01 3843 R1320	LS33M43L20	55	1SBV 01 3892 R1202	LS33M92B02	59
1SBV 01 3791 R1202	LS35M91B02	59	1SBV 01 3843 R1411	LS33M43D11	55	1SBV 01 3892 R1211	LS33M92B11	59
1SBV 01 3791 R1211	LS35M91B11	59	1SBV 01 3843 R1511	LS33M43C11	55	1SBV 01 3892 R1302	LS33M92L02	59
1SBV 01 3791 R1302	LS35M91L02	59	1SBV 01 3845 R1202	LS33M45B02	55	1SBV 01 3892 R1320	LS33M92L20	59
1SBV 01 3791 R1320	LS35M91L20	59	1SBV 01 3845 R1211	LS33M45B11	55	1SBV 01 3892 R1411	LS33M92D11	59
1SBV 01 3791 R1411	LS35M91D11	59	1SBV 01 3845 R1302	LS33M45L02	55	1SBV 01 3892 R1511	LS33M92C11	59
1SBV 01 3791 R1511	LS35M91C11	59	1SBV 01 3845 R1320	LS33M45L20	55	1SBV 01 3898 R1211	LS33M98B11-A	59
1SBV 01 3792 R1202	LS35M92B02	59	1SBV 01 3845 R1411	LS33M45D11	55	1SBV 01 3898 R1302	LS33M98L02-A	59
1SBV 01 3792 R1211	LS35M92B11	59	1SBV 01 3845 R1511	LS33M45C11	55	1SBV 01 3898 R1320	LS33M98L20-A	59
1SBV 01 3792 R1302	LS35M92L02	59	1SBV 01 3846 R1202	LS33M46B02	55	1SBV 01 3898 R1411	LS33M98D11-A	59
1SBV 01 3792 R1320	LS35M92L20	59	1SBV 01 3846 R1211	LS33M46B11	55			
1SBV 01 3792 R1411	LS35M92D11	59	1SBV 01 3846 R1302	LS33M46L02	55	1SBV 01 431...		
1SBV 01 3792 R1511	LS35M92C11	59	1SBV 01 3846 R1320	LS33M46L20	55	1SBV 01 4311 R1202	LS72M11B02	60
1SBV 01 3798 R1211	LS35M98B11-A	59	1SBV 01 3846 R1411	LS33M46D11	55	1SBV 01 4311 R1211	LS72M11B11	60
1SBV 01 3798 R1302	LS35M98L02-A	59	1SBV 01 3846 R1511	LS33M46C11	55	1SBV 01 4311 R1302	LS72M11L02	60
1SBV 01 3798 R1320	LS35M98L20-A	59				1SBV 01 4311 R1320	LS72M11L20	60
1SBV 01 3798 R1411	LS35M98D11-A	59	1SBV 01 385...			1SBV 01 4311 R1411	LS72M11D11	60
1SBV 01 381...			1SBV 01 3851 R1202	LS33M51B02	56	1SBV 01 4311 R1511	LS72M11C11	60
1SBV 01 3811 R1202	LS33M11B02	52	1SBV 01 3851 R1211	LS33M51B11	56	1SBV 01 4312 R1202	LS72M12B02	60
1SBV 01 3811 R1211	LS33M11B11	52	1SBV 01 3851 R1302	LS33M51L02	56	1SBV 01 4312 R1211	LS72M12B11	60
1SBV 01 3811 R1302	LS33M11L02	52	1SBV 01 3851 R1320	LS33M51L20	56	1SBV 01 4312 R1302	LS72M12L02	60
1SBV 01 3811 R1320	LS33M11L20	52	1SBV 01 3851 R1411	LS33M51D11	56	1SBV 01 4312 R1320	LS72M12L20	60
1SBV 01 3811 R1411	LS33M11D11	52	1SBV 01 3851 R1511	LS33M51C11	56	1SBV 01 4312 R1411	LS72M12D11	60
1SBV 01 3811 R1511	LS33M11C11	52	1SBV 01 3852 R1202	LS33M52B02	56	1SBV 01 4312 R1511	LS72M12C11	60
1SBV 01 3812 R1202	LS33M12B02	52	1SBV 01 3852 R1211	LS33M52B11	56	1SBV 01 4313 R1202	LS72M13B02	60
1SBV 01 3812 R1211	LS33M12B11	52	1SBV 01 3852 R1302	LS33M52L02	56	1SBV 01 4313 R1211	LS72M13B11	60
1SBV 01 3812 R1302	LS33M12L02	52	1SBV 01 3852 R1320	LS33M52L20	56	1SBV 01 4313 R1302	LS72M13L02	60
1SBV 01 3812 R1320	LS33M12L20	52	1SBV 01 3852 R1411	LS33M52D11	56	1SBV 01 4313 R1320	LS72M13L20	60
1SBV 01 3812 R1411	LS33M12D11	52	1SBV 01 3852 R1511	LS33M52C11	56	1SBV 01 4313 R1411	LS72M13D11	60
1SBV 01 3812 R1511	LS33M12C11	52	1SBV 01 3853 R1202	LS33M53B02	56	1SBV 01 4313 R1511	LS72M13C11	60
1SBV 01 3813 R1202	LS33M13B02	52	1SBV 01 3853 R1211	LS33M53B11	56			
1SBV 01 3813 R1211	LS33M13B11	52	1SBV 01 3853 R1302	LS33M53L02	56	1SBV 01 433...		
1SBV 01 3813 R1302	LS33M13L02	52	1SBV 01 3853 R1320	LS33M53L20	56	1SBV 01 4331 R1202	LS72M31B02	61
1SBV 01 3813 R1320	LS33M13L20	52	1SBV 01 3853 R1411	LS33M53D11	56	1SBV 01 4331 R1211	LS72M31B11	61
1SBV 01 3813 R1411	LS33M13D11	52	1SBV 01 3853 R1511	LS33M53C11	56	1SBV 01 4331 R1302	LS72M31L02	61
1SBV 01 3813 R1511	LS33M13C11	52	1SBV 01 3855 R1202	LS33M55B02	57	1SBV 01 4331 R1320	LS72M31L20	61
1SBV 01 3814 R1202	LS33M14B02	53	1SBV 01 3855 R1211	LS33M55B11	57	1SBV 01 4331 R1411	LS72M31D11	61
1SBV 01 3814 R1211	LS33M14B11	53	1SBV 01 3855 R1302	LS33M55L02	57	1SBV 01 4331 R1511	LS72M31C11	61
1SBV 01 3814 R1302	LS33M14L02	53	1SBV 01 3855 R1320	LS33M55L20	57	1SBV 01 4335 R1202	LS72M35B02	61
1SBV 01 3814 R1320	LS33M14L20	53	1SBV 01 3855 R1411	LS33M55D11	57	1SBV 01 4335 R1211	LS72M35B11	61
1SBV 01 3814 R1411	LS33M14D11	53	1SBV 01 3855 R1511	LS33M55C11	57	1SBV 01 4335 R1302	LS72M35L02	61
1SBV 01 3814 R1511	LS33M14C11	53				1SBV 01 4335 R1320	LS72M35L20	61
1SBV 01 383...			1SBV 01 387...			1SBV 01 4335 R1411	LS72M35D11	61
1SBV 01 3831 R1202	LS33M31B02	53	1SBV 01 3871 R1202	LS33M71B02	57	1SBV 01 4335 R1511	LS72M35C11	61
1SBV 01 3831 R1211	LS33M31B11	53	1SBV 01 3871 R1211	LS33M71B11	57	1SBV 01 4338 R1202	LS72M38B02	61
1SBV 01 3831 R1302	LS33M31L02	53	1SBV 01 3871 R1302	LS33M71L02	57	1SBV 01 4338 R1211	LS72M38B11	61
1SBV 01 3831 R1320	LS33M31L20	53	1SBV 01 3871 R1320	LS33M71L20	57	1SBV 01 4338 R1302	LS72M38L02	61
1SBV 01 3831 R1411	LS33M31D11	53	1SBV 01 3871 R1411	LS33M71D11	57	1SBV 01 4338 R1320	LS72M38L20	61
1SBV 01 3831 R1511	LS33M31C11	53	1SBV 01 3871 R1511	LS33M71C11	57	1SBV 01 4338 R1411	LS72M38D11	61
1SBV 01 3832 R1202	LS33M32B02	53	1SBV 01 3872 R1202	LS33M72B02	57	1SBV 01 4338 R1511	LS72M38C11	61
1SBV 01 3832 R1211	LS33M32B11	53	1SBV 01 3872 R1211	LS33M72B11	57			
1SBV 01 3832 R1302	LS33M32L02	53	1SBV 01 3872 R1211	LS33M72L02	57	1SBV 01 434...		
1SBV 01 3832 R1320	LS33M32L20	53	1SBV 01 3872 R1302	LS33M72L20	57	1SBV 01 4341 R1202	LS72M41B02	62
1SBV 01 3832 R1411	LS33M32D11	53	1SBV 01 3872 R1320	LS33M72D11	57	1SBV 01 4341 R1211	LS72M41B11	62
1SBV 01 3832 R1511	LS33M32C11	53	1SBV 01 3872 R1411	LS33M72D11	57	1SBV 01 4341 R1302	LS72M41L02	62
1SBV 01 3838 R1202	LS33M38B02	54	1SBV 01 3872 R1511	LS33M72C11	57	1SBV 01 4341 R1320	LS72M41L20	62
1SBV 01 3838 R1211	LS33M38B11	54	1SBV 01 3873 R1202	LS33M73B02	58	1SBV 01 4341 R1411	LS72M41D11	62
1SBV 01 3838 R1302	LS33M38L02	54	1SBV 01 3873 R1211	LS33M73B11	58	1SBV 01 4341 R1511	LS72M41C11	62
			1SBV 01 3873 R1302	LS33M73L02	58	1SBV 01 4342 R1202	LS72M42B02	62
			1SBV 01 3873 R1411	LS33M73D11	58	1SBV 01 4342 R1211	LS72M42B11	62
			1SBV 01 3873 R1511	LS33M73C11	58	1SBV 01 4342 R1302	LS72M42L02	62

Index

Classification by Order Code

Order Code	Type	Page	Order Code	Type	Page	Order Code	Type	Page
1SBV 01 4342 R1320	LS72M42L20	62	1SBV 01 4378 R1202	LS72M78B02	66	1SBV 01 5143 R1320	LS75M43L20	62
1SBV 01 4342 R1411	LS72M42D11	62	1SBV 01 4378 R1211	LS72M78B11	66	1SBV 01 5143 R1411	LS75M43D11	62
1SBV 01 4342 R1511	LS72M42C11	62	1SBV 01 4378 R1302	LS72M78L02	66	1SBV 01 5143 R1511	LS75M43C11	62
1SBV 01 4343 R1202	LS72M43B02	62	1SBV 01 4378 R1320	LS72M78L20	66	1SBV 01 5145 R1202	LS75M45B02	63
1SBV 01 4343 R1211	LS72M43B11	62	1SBV 01 4378 R1411	LS72M78D11	66	1SBV 01 5145 R1211	LS75M45B11	63
1SBV 01 4343 R1302	LS72M43L02	62	1SBV 01 4378 R1511	LS72M78C11	66	1SBV 01 5145 R1302	LS75M45L02	63
1SBV 01 4343 R1320	LS72M43L20	62				1SBV 01 5145 R1320	LS75M45L20	63
1SBV 01 4343 R1411	LS72M43D11	62	1SBV 01 439...			1SBV 01 5145 R1411	LS75M45D11	63
1SBV 01 4343 R1511	LS72M43C11	62	1SBV 01 4391 R1202	LS72M91B02	67	1SBV 01 5145 R1511	LS75M45C11	63
1SBV 01 4345 R1202	LS72M45B02	63	1SBV 01 4391 R1211	LS72M91B11	67	1SBV 01 5146 R1202	LS75M46B02	63
1SBV 01 4345 R1211	LS72M45B11	63	1SBV 01 4391 R1302	LS72M91L02	67	1SBV 01 5146 R1211	LS75M46B11	63
1SBV 01 4345 R1302	LS72M45L02	63	1SBV 01 4391 R1320	LS72M91L20	67	1SBV 01 5146 R1302	LS75M46L02	63
1SBV 01 4345 R1320	LS72M45L20	63	1SBV 01 4391 R1411	LS72M91D11	67	1SBV 01 5146 R1320	LS75M46L20	63
1SBV 01 4345 R1411	LS72M45D11	63	1SBV 01 4391 R1511	LS72M91C11	67	1SBV 01 5146 R1411	LS75M46D11	63
1SBV 01 4345 R1511	LS72M45C11	63	1SBV 01 4392 R1202	LS72M92B02	67	1SBV 01 5146 R1511	LS75M46C11	63
1SBV 01 4346 R1202	LS72M46B02	63	1SBV 01 4392 R1211	LS72M92B11	67			
1SBV 01 4346 R1211	LS72M46B11	63	1SBV 01 4392 R1302	LS72M92L02	67	1SBV 01 515...		
1SBV 01 4346 R1302	LS72M46L02	63	1SBV 01 4392 R1320	LS72M92L20	67	1SBV 01 5151 R1202	LS75M51B02	63
1SBV 01 4346 R1320	LS72M46L20	63	1SBV 01 4392 R1411	LS72M92D11	67	1SBV 01 5151 R1302	LS75M51L02	63
1SBV 01 4346 R1411	LS72M46D11	63	1SBV 01 4392 R1511	LS72M92C11	67	1SBV 01 5151 R1320	LS75M51L20	63
1SBV 01 4346 R1511	LS72M46C11	63	1SBV 01 4398 R1211	LS72M98B11-A	67	1SBV 01 5151 R1411	LS75M51D11	63
			1SBV 01 4398 R1302	LS72M98L02-A	67	1SBV 01 5151 R1511	LS75M51C11	63
1SBV 01 435...			1SBV 01 4398 R1320	LS72M98L20-A	67	1SBV 01 5152 R1202	LS75M52B02	64
1SBV 01 4351 R1202	LS72M51B02	63	1SBV 01 4398 R1411	LS72M98D11-A	67	1SBV 01 5152 R1211	LS75M52B11	64
1SBV 01 4351 R1211	LS72M51B11	63				1SBV 01 5152 R1302	LS75M52L02	64
1SBV 01 4351 R1302	LS72M51L02	63	1SBV 01 511...			1SBV 01 5152 R1320	LS75M52L20	64
1SBV 01 4351 R1320	LS72M51L20	63	1SBV 01 5111 R1202	LS75M11B02	60	1SBV 01 5152 R1411	LS75M52D11	64
1SBV 01 4351 R1411	LS72M51D11	63	1SBV 01 5111 R1211	LS75M11B11	60	1SBV 01 5152 R1511	LS75M52C11	64
1SBV 01 4351 R1511	LS72M51C11	63	1SBV 01 5111 R1302	LS75M11L02	60	1SBV 01 5153 R1202	LS75M53B02	64
1SBV 01 4352 R1202	LS72M52B02	64	1SBV 01 5111 R1320	LS75M11L20	60	1SBV 01 5153 R1211	LS75M53B11	64
1SBV 01 4352 R1211	LS72M52B11	64	1SBV 01 5111 R1411	LS75M11D11	60	1SBV 01 5153 R1302	LS75M53L02	64
1SBV 01 4352 R1302	LS72M52L02	64	1SBV 01 5111 R1511	LS75M11C11	60	1SBV 01 5153 R1320	LS75M53L20	64
1SBV 01 4352 R1320	LS72M52L20	64	1SBV 01 5112 R1202	LS75M12B02	60	1SBV 01 5153 R1411	LS75M53D11	64
1SBV 01 4352 R1411	LS72M52D11	64	1SBV 01 5112 R1211	LS75M12B11	60	1SBV 01 5153 R1511	LS75M53C11	64
1SBV 01 4352 R1511	LS72M52C11	64	1SBV 01 5112 R1302	LS75M12L02	60			
1SBV 01 4353 R1202	LS72M53B02	64	1SBV 01 5112 R1320	LS75M12L20	60	1SBV 01 516...		
1SBV 01 4353 R1211	LS72M53B11	64	1SBV 01 5112 R1411	LS75M12D11	60	1SBV 01 5161 R1202	LS75M61B02	64
1SBV 01 4353 R1302	LS72M53L02	64	1SBV 01 5112 R1511	LS75M12C11	60	1SBV 01 5161 R1211	LS75M61B11	64
1SBV 01 4353 R1320	LS72M53L20	64	1SBV 01 5113 R1202	LS75M13B02	60	1SBV 01 5161 R1302	LS75M61L02	64
1SBV 01 4353 R1411	LS72M53D11	64	1SBV 01 5113 R1211	LS75M13B11	60	1SBV 01 5161 R1320	LS75M61L20	64
1SBV 01 4353 R1511	LS72M53C11	64	1SBV 01 5113 R1302	LS75M13L02	60	1SBV 01 5161 R1411	LS75M61D11	64
			1SBV 01 5113 R1320	LS75M13L20	60	1SBV 01 5161 R1511	LS75M61C11	64
1SBV 01 436...			1SBV 01 5113 R1411	LS75M13D11	60	1SBV 01 5162 R1202	LS75M62B02	65
1SBV 01 4361 R1202	LS72M61B02	64	1SBV 01 5113 R1511	LS75M13C11	60	1SBV 01 5162 R1211	LS75M62B11	65
1SBV 01 4361 R1211	LS72M61B11	64				1SBV 01 5162 R1302	LS75M62L02	65
1SBV 01 4361 R1302	LS72M61L02	64	1SBV 01 513...			1SBV 01 5162 R1320	LS75M62L20	65
1SBV 01 4361 R1320	LS72M61L20	64	1SBV 01 5131 R1202	LS75M31B02	61	1SBV 01 5162 R1411	LS75M62D11	65
1SBV 01 4361 R1411	LS72M61D11	64	1SBV 01 5131 R1211	LS75M31B11	61	1SBV 01 5162 R1511	LS75M62C11	65
1SBV 01 4361 R1511	LS72M61C11	64	1SBV 01 5131 R1302	LS75M31L02	61			
1SBV 01 4362 R1202	LS72M62B02	65	1SBV 01 5131 R1320	LS75M31L20	61	1SBV 01 517...		
1SBV 01 4362 R1211	LS72M62B11	65	1SBV 01 5131 R1411	LS75M31D11	61	1SBV 01 5171 R1202	LS75M71B02	65
1SBV 01 4362 R1302	LS72M62L02	65	1SBV 01 5131 R1511	LS75M31C11	61	1SBV 01 5171 R1211	LS75M71B11	65
1SBV 01 4362 R1320	LS72M62L20	65	1SBV 01 5135 R1202	LS75M35B02	61	1SBV 01 5171 R1302	LS75M71L02	65
1SBV 01 4362 R1411	LS72M62D11	65	1SBV 01 5135 R1211	LS75M35B11	61	1SBV 01 5171 R1320	LS75M71L20	65
1SBV 01 4362 R1511	LS72M62C11	65	1SBV 01 5135 R1302	LS75M35L02	61	1SBV 01 5171 R1411	LS75M71D11	65
			1SBV 01 5135 R1320	LS75M35L20	61	1SBV 01 5171 R1511	LS75M71C11	65
1SBV 01 437...			1SBV 01 5135 R1411	LS75M35D11	61	1SBV 01 5172 R1202	LS75M72B02	65
1SBV 01 4371 R1202	LS72M71B02	65	1SBV 01 5135 R1511	LS75M35C11	61	1SBV 01 5172 R1211	LS75M72B11	65
1SBV 01 4371 R1211	LS72M71B11	65	1SBV 01 5138 R1202	LS75M38B02	61	1SBV 01 5172 R1302	LS75M72L02	65
1SBV 01 4371 R1302	LS72M71L02	65	1SBV 01 5138 R1211	LS75M38B11	61	1SBV 01 5172 R1320	LS75M72L20	65
1SBV 01 4371 R1320	LS72M71L20	65	1SBV 01 5138 R1302	LS75M38L02	61	1SBV 01 5172 R1411	LS75M72D11	65
1SBV 01 4371 R1411	LS72M71D11	65	1SBV 01 5138 R1320	LS75M38L20	61	1SBV 01 5172 R1511	LS75M72C11	65
1SBV 01 4371 R1511	LS72M71C11	65	1SBV 01 5138 R1411	LS75M38D11	61	1SBV 01 5173 R1202	LS75M73B02	66
1SBV 01 4372 R1202	LS72M72B02	65	1SBV 01 5138 R1511	LS75M38C11	61	1SBV 01 5173 R1211	LS75M73B11	66
1SBV 01 4372 R1211	LS72M72B11	65				1SBV 01 5173 R1302	LS75M73L02	66
1SBV 01 4372 R1302	LS72M72L02	65	1SBV 01 514...			1SBV 01 5173 R1320	LS75M73L20	66
1SBV 01 4372 R1320	LS72M72L20	65	1SBV 01 5141 R1202	LS75M41B02	62	1SBV 01 5173 R1411	LS75M73D11	66
1SBV 01 4372 R1411	LS72M72D11	65	1SBV 01 5141 R1211	LS75M41B11	62	1SBV 01 5173 R1511	LS75M73C11	66
1SBV 01 4372 R1511	LS72M72C11	65	1SBV 01 5141 R1302	LS75M41L02	62	1SBV 01 5174 R1202	LS75M74B02	66
1SBV 01 4373 R1202	LS72M73B02	66	1SBV 01 5141 R1320	LS75M41L20	62	1SBV 01 5174 R1211	LS75M74B11	66
1SBV 01 4373 R1211	LS72M73B11	66	1SBV 01 5141 R1411	LS75M41D11	62	1SBV 01 5174 R1302	LS75M74L02	66
1SBV 01 4373 R1302	LS72M73L02	66	1SBV 01 5141 R1511	LS75M41C11	62	1SBV 01 5174 R1320	LS75M74L20	66
1SBV 01 4373 R1320	LS72M73L20	66	1SBV 01 5142 R1202	LS75M42B02	62	1SBV 01 5174 R1411	LS75M74D11	66
1SBV 01 4373 R1411	LS72M73D11	66	1SBV 01 5142 R1211	LS75M42B11	62	1SBV 01 5174 R1511	LS75M74C11	66
1SBV 01 4373 R1511	LS72M73C11	66	1SBV 01 5142 R1302	LS75M42L02	62	1SBV 01 5178 R1202	LS75M78B02	66
1SBV 01 4374 R1202	LS72M74B02	66	1SBV 01 5142 R1320	LS75M42L20	62	1SBV 01 5178 R1211	LS75M78B11	66
1SBV 01 4374 R1211	LS72M74B11	66	1SBV 01 5142 R1411	LS75M42D11	62	1SBV 01 5178 R1302	LS75M78L02	66
1SBV 01 4374 R1302	LS72M74L02	66	1SBV 01 5142 R1511	LS75M42C11	62	1SBV 01 5178 R1320	LS75M78L20	66
1SBV 01 4374 R1320	LS72M74L20	66	1SBV 01 5143 R1202	LS75M43B02	62	1SBV 01 5178 R1411	LS75M78D11	66
1SBV 01 4374 R1411	LS72M74D11	66	1SBV 01 5143 R1211	LS75M43B11	62	1SBV 01 5178 R1511	LS75M78C11	66
1SBV 01 4374 R1511	LS72M74C11	66	1SBV 01 5143 R1302	LS75M43L02	62			

Index

Classification by Order Code

Order Code	Type	Page	Order Code	Type	Page	Order Code	Type	Page
1SBV 01 519...			1SBV 01 5245 R1511			1SBV 01 5292 R1202		
1SBV 01 5191 R1202	LS75M91B02	67	1SBV 01 5246 R1202	LS73M45C11	63	1SBV 01 5292 R1211	LS73M92B02	67
1SBV 01 5191 R1211	LS75M91B11	67	1SBV 01 5246 R1211	LS73M46B02	63	1SBV 01 5292 R1302	LS73M92B11	67
1SBV 01 5191 R1302	LS75M91L02	67	1SBV 01 5246 R1302	LS73M46B11	63	1SBV 01 5292 R1320	LS73M92L02	67
1SBV 01 5191 R1320	LS75M91L20	67	1SBV 01 5246 R1320	LS73M46L02	63	1SBV 01 5292 R1411	LS73M92L20	67
1SBV 01 5191 R1411	LS75M91D11	67	1SBV 01 5246 R1320	LS73M46L20	63	1SBV 01 5292 R1511	LS73M92D11	67
1SBV 01 5191 R1511	LS75M91C11	67	1SBV 01 5246 R1411	LS73M46D11	63	1SBV 01 5298 R1211	LS73M92C11	67
1SBV 01 5192 R1202	LS75M92B02	67	1SBV 01 5246 R1511	LS73M46C11	63	1SBV 01 5298 R1211	LS73M98B11-A	67
1SBV 01 5192 R1211	LS75M92B11	67	1SBV 01 525...			1SBV 01 5298 R1302	LS73M98L02-A	67
1SBV 01 5192 R1302	LS75M92L02	67	1SBV 01 5251 R1202	LS73M51B02	63	1SBV 01 5298 R1320	LS73M98L20-A	67
1SBV 01 5192 R1320	LS75M92L20	67	1SBV 01 5251 R1211	LS73M51B11	63	1SBV 01 5298 R1411	LS73M98D11-A	67
1SBV 01 5192 R1411	LS75M92D11	67	1SBV 01 5251 R1302	LS73M51L02	63			
1SBV 01 5192 R1511	LS75M92C11	67	1SBV 01 5251 R1320	LS73M51L20	63			
1SBV 01 5198 R1211	LS75M98B11-A	67	1SBV 01 5251 R1411	LS73M51D11	63			
1SBV 01 5198 R1302	LS75M98L02-A	67	1SBV 01 5251 R1511	LS73M51C11	63			
1SBV 01 5198 R1320	LS75M98L20-A	67	1SBV 01 5252 R1202	LS73M52B02	64			
1SBV 01 5198 R1411	LS75M98D11-A	67	1SBV 01 5252 R1211	LS73M52B11	64			
			1SBV 01 5252 R1302	LS73M52L02	64			
1SBV 01 521...			1SBV 01 5252 R1320	LS73M52L20	64			
1SBV 01 5211 R1202	LS73M11B02	60	1SBV 01 5252 R1411	LS73M52D11	64			
1SBV 01 5211 R1211	LS73M11B11	60	1SBV 01 5252 R1511	LS73M52C11	64			
1SBV 01 5211 R1302	LS73M11L02	60	1SBV 01 5253 R1202	LS73M53B02	64			
1SBV 01 5211 R1320	LS73M11L20	60	1SBV 01 5253 R1211	LS73M53B11	64			
1SBV 01 5211 R1411	LS73M11D11	60	1SBV 01 5253 R1302	LS73M53L02	64			
1SBV 01 5211 R1511	LS73M11C11	60	1SBV 01 5253 R1320	LS73M53L20	64			
1SBV 01 5212 R1202	LS73M12B02	60	1SBV 01 5253 R1411	LS73M53D11	64			
1SBV 01 5212 R1211	LS73M12B11	60	1SBV 01 5253 R1511	LS73M53C11	64			
1SBV 01 5212 R1302	LS73M12L02	60	1SBV 01 526...					
1SBV 01 5212 R1320	LS73M12L20	60	1SBV 01 5261 R1202	LS73M61B02	64			
1SBV 01 5212 R1411	LS73M12D11	60	1SBV 01 5261 R1211	LS73M61B11	64			
1SBV 01 5212 R1511	LS73M12C11	60	1SBV 01 5261 R1302	LS73M61L02	64			
1SBV 01 5213 R1202	LS73M13B02	60	1SBV 01 5261 R1320	LS73M61L20	64			
1SBV 01 5213 R1211	LS73M13B11	60	1SBV 01 5261 R1411	LS73M61D11	64			
1SBV 01 5213 R1302	LS73M13L02	60	1SBV 01 5261 R1511	LS73M61C11	64			
1SBV 01 5213 R1320	LS73M13L20	60	1SBV 01 5262 R1202	LS73M62B02	65			
1SBV 01 5213 R1411	LS73M13D11	60	1SBV 01 5262 R1211	LS73M62B11	65			
1SBV 01 5213 R1511	LS73M13C11	60	1SBV 01 5262 R1302	LS73M62L02	65			
			1SBV 01 5262 R1320	LS73M62L20	65			
1SBV 01 523...			1SBV 01 5262 R1411	LS73M62D11	65			
1SBV 01 5231 R1202	LS73M31B02	61	1SBV 01 5262 R1511	LS73M62C11	65			
1SBV 01 5231 R1211	LS73M31B11	61	1SBV 01 527...					
1SBV 01 5231 R1302	LS73M31L02	61	1SBV 01 5271 R1202	LS73M71B02	65			
1SBV 01 5231 R1320	LS73M31L20	61	1SBV 01 5271 R1211	LS73M71B11	65			
1SBV 01 5231 R1411	LS73M31D11	61	1SBV 01 5271 R1302	LS73M71L02	65			
1SBV 01 5231 R1511	LS73M31C11	61	1SBV 01 5271 R1320	LS73M71L20	65			
1SBV 01 5235 R1202	LS73M35B02	61	1SBV 01 5271 R1411	LS73M71D11	65			
1SBV 01 5235 R1211	LS73M35B11	61	1SBV 01 5271 R1511	LS73M71C11	65			
1SBV 01 5235 R1302	LS73M35L02	61	1SBV 01 5272 R1202	LS73M72B02	65			
1SBV 01 5235 R1320	LS73M35L20	61	1SBV 01 5272 R1211	LS73M72B11	65			
1SBV 01 5235 R1511	LS73M35C11	61	1SBV 01 5272 R1302	LS73M72L02	65			
1SBV 01 5238 R1202	LS73M38B02	61	1SBV 01 5272 R1320	LS73M72L20	65			
1SBV 01 5238 R1211	LS73M38B11	61	1SBV 01 5272 R1411	LS73M72D11	65			
1SBV 01 5238 R1302	LS73M38L02	61	1SBV 01 5272 R1511	LS73M72C11	65			
1SBV 01 5238 R1320	LS73M38L20	61	1SBV 01 5273 R1202	LS73M73B02	66			
1SBV 01 5238 R1411	LS73M38D11	61	1SBV 01 5273 R1211	LS73M73B11	66			
1SBV 01 5238 R1511	LS73M38C11	61	1SBV 01 5273 R1302	LS73M73L02	66			
			1SBV 01 5273 R1320	LS73M73L20	66			
1SBV 01 524...			1SBV 01 5273 R1411	LS73M73D11	66			
1SBV 01 5241 R1202	LS73M41B02	62	1SBV 01 5273 R1511	LS73M73C11	66			
1SBV 01 5241 R1211	LS73M41B11	62	1SBV 01 5274 R1202	LS73M74B02	66			
1SBV 01 5241 R1302	LS73M41L02	62	1SBV 01 5274 R1211	LS73M74B11	66			
1SBV 01 5241 R1320	LS73M41L20	62	1SBV 01 5274 R1302	LS73M74L02	66			
1SBV 01 5241 R1411	LS73M41D11	62	1SBV 01 5274 R1320	LS73M74L20	66			
1SBV 01 5241 R1511	LS73M41C11	62	1SBV 01 5274 R1411	LS73M74D11	66			
1SBV 01 5242 R1202	LS73M42B02	62	1SBV 01 5274 R1511	LS73M74C11	66			
1SBV 01 5242 R1211	LS73M42B11	62	1SBV 01 5278 R1202	LS73M78B02	66			
1SBV 01 5242 R1302	LS73M42L02	62	1SBV 01 5278 R1211	LS73M78B11	66			
1SBV 01 5242 R1320	LS73M42L20	62	1SBV 01 5278 R1302	LS73M78L02	66			
1SBV 01 5242 R1411	LS73M42D11	62	1SBV 01 5278 R1320	LS73M78L20	66			
1SBV 01 5242 R1511	LS73M42C11	62	1SBV 01 5278 R1411	LS73M78D11	66			
1SBV 01 5243 R1202	LS73M43B02	62	1SBV 01 5278 R1511	LS73M78C11	66			
1SBV 01 5243 R1211	LS73M43B11	62	1SBV 01 529...					
1SBV 01 5243 R1302	LS73M43L02	62	1SBV 01 5291 R1202	LS73M91B02	67			
1SBV 01 5243 R1320	LS73M43L20	62	1SBV 01 5291 R1211	LS73M91B11	67			
1SBV 01 5243 R1411	LS73M43D11	62	1SBV 01 5291 R1302	LS73M91L02	67			
1SBV 01 5243 R1511	LS73M43C11	62	1SBV 01 5291 R1320	LS73M91L20	67			
1SBV 01 5245 R1202	LS73M45B02	63	1SBV 01 5291 R1411	LS73M91D11	67			
1SBV 01 5245 R1211	LS73M45B11	63	1SBV 01 5291 R1511	LS73M91C11	67			
1SBV 01 5245 R1302	LS73M45L02	63						
1SBV 01 5245 R1320	LS73M45L20	63						
1SBV 01 5245 R1411	LS73M45D11	63						



ABB Entrelec

10, rue Ampère Z.I. - B.P. 114
F-69685 Chassieu cedex / France
Telephone: +33 (0) 4 7222 1722
Telefax: +33 (0) 4 7222 1935
<http://www.abb.com/lowvoltage>

As part of its on-going product improvement, ABB reserves the right to modify the characteristics or the products described in this document.
The information given is not-contractual. For further details please contact the ABB company marketing these products in your country.

Publication
No: 1SBC141138C0201
Printed in France (V+Y 04.2004 FE)