

STEPPING SYSTEMS

2
Phase

Stepping Systems



SANYO DENKI



Safety Consideration

The PM drivers and stepping motors are the products designed to be used for the general industrial devices.

When using those, pay enough attention to the following points.

- Read thoroughly the Operation Manual prior to placement, assembly and/or operation in order to use the product properly.
- Refrain from modifying or processing the product in any way.
- Consult with the distributor or professional experts for placement or maintenance services of the product.
- In case of the following uses of the product, contact with us for the special care required to the operation, maintenance and management such as multiplexing the system, installing an emergency electric generator set, or so forth.

- ① Use for the medical devices concerned with a fatal accident.
- ② Use for trains, elevators, and so forth that are likely to cause an accident resulting in injury, damage or death.
- ③ Use in the computer system highly influential to the social life or the public systems.
- ④ Use in other devices highly influential to maintaining the human safety or the public functions.

In addition to the above, consult with us for use in such a vibration environment as automobile or transportation.

Read the Operation Manual thoroughly prior to the use (placement, operation, maintenance and inspection) to put the product in use properly.

Make yourself knowledgeable and familiarize with the devices, safety issues and cautions before handling the product.

After reading the Operation Manual or the like, keep it in the place where the users can refer to whenever necessary.

Indication by (Warning Label) on the product

Either or all of the following indications are given by the Warning Labels depending on the type of the PM driver or stepping motor.



This label is stuck near the high voltage part such as the electrically charged or cover-protected section, warning that the place where it is likely to cause an electric shock.



This label is stuck on the place where the PM driver or stepping motor body should be easily acknowledged, warning that it is likely to cause burns from high temperature.



This label is stuck near the GND terminals of the PM driver or stepping motor for which grounding is required, suggesting that the terminals should be actually grounded.



This label is stuck for the PM driver or stepping motor to which the power source is applied in the voltage exceeding the safety standard, drawing attention against the electric shock.

Safety ranks of the cautions

Following four ranks are provided.



DANGER Improper operations or use is most likely to result in serious injury or death.



CAUTION Improper operations or use is likely to result in average or minor injury, or in property damage.

In spite of the cautions with the  CAUTION label, it may cause serious results. Either the contents of the labels is describing important cautions to be followed inevitably.



PROHIBITED Indicates what shall not be done.



COMPULSORY Indicates what shall be done.

DANGER

< General matters >

1. Do not use the product in an explosive, flammable or corrosive atmosphere, watery place or near a combustible material. Doing so may cause injury or fire.
2. Have a person with expert knowledge for performing the transportation, placement, wiring, operation, maintenance or inspection of the product. Without such knowledge, it may cause an electric shock, injury or fire.
3. Do not work for wiring, maintenance servicing or inspection with the electric power on. Perform either of those five minutes after turning the power off, or otherwise, it may cause an electric shock.
4. When the protective functions of the product is activated, turn the power off immediately and eliminate the cause. If continuing the operation without eliminating the cause, the product may operate improperly and cause injury or a breakdown of the system devices.
5. Stepping motor may run out of order at the operating and stopping occasions, depending on the magnitude of the load. Put the product into use after confirming with the adequate trial test operation in the maximum load conditions that the product performs reliable operation. Doing otherwise may cause a breakdown of the system. (Should the product run out of order in the use to drive upward/downward, it may cause a fall of the load.)
6. Do not touch the internal parts of the PM driver. Doing so may cause an electric shock.

< Wiring >

7. Do not connect the stepping motor directly with the commercial power outlet. Doing so may cause an electric shock, injury or fire. The power shall be supplied to the stepping motor through the driving circuit.
8. Use the electric power source within the rated input voltage. Using otherwise may cause fire or an electric shock.
9. Connect the PM driver and stepping motor to the ground. Using without grounding may cause an electric shock.
10. Do not harm, forcibly put a stress, or load a heavy article on the cable or get it caught between the articles. Doing so may cause an electric shock.
11. Perform wiring with the power cable as instructed by the wiring diagram or the Operation Manual. Doing otherwise may cause an electric shock or fire.

< Operation >

12. Be sure not to touch the rotating part of the stepping motor during its operation. Touching it may cause injury.
13. Neither reach or touch the electric terminals while electric power is on. Doing so may cause an electric shock.
14. Never disconnect any of the connectors while electric power is on. Doing so may cause an electric shock and corruption.

CAUTION

< General matters >

1. Prior to placement, operation, maintenance servicing or inspection, be sure to read the Operation Manual and follow the instructions to perform those. Failure to follow the instructions may cause an electric shock, injury or fire.
2. Do not use the PM driver or the stepping motor outside the specified conditions. Doing so may cause an electric shock, injury or fire.
3. Do not insert a finger or a thing into the opening of the product. Doing so may cause an electric shock, injury or fire.
4. Do not use the damaged PM driver or stepping motor. Doing so may cause injury, fire or the like.
5. Use the PM driver and stepping motor in the designated combination. Using otherwise may cause fire or a trouble.
6. Be careful that the temperature rises in the operating PM driver, stepping motor or peripheral devices. Failure to be careful may cause a burn.

< Unpacking >

7. Unpack while confirming the ceiling. Failure to do so may cause injury.
8. Confirm if the product is the one having been ordered. Installing an incorrect product may cause a breakdown.

< Wiring >

9. Do not perform measurement of the insulation resistance or withstand insulation voltage of the product. Doing so may cause a breakdown. Instead, contact with us for such inspection.
10. Perform wiring conforming to the technical standards of electric facility or the internal rule. Doing otherwise may cause burning or fire.
11. Ensure that wiring has been correctly done. Operating without correct wiring may cause the stepping motor to run out of control and result in injury.
12. Take insulation process for the attached condenser or the external resistance connection terminals. Failure to do so may cause an electric shock.

< Placement >

13. Do not climb or attach a heavy article on the product. Doing so may cause injury.
14. Neither block nor stuff the aspiration/exhaust vent with a foreign particle. Doing so may cause fire.
15. Follow the instructions for the direction to place. Failure to do so may cause a trouble.
16. Keep a distance as instructed by the Operation Manual for the PM driver from the inner surface of the control console or other devices. Failure to do so may cause a trouble.
17. Place the product with a great care so as to prevent from the danger such as a tumble or a turnover.
18. Mount the product on an incombustible material such as metal. Doing otherwise may cause fire.

19. Confirm the rotating direction before connecting with the mechanical device. Failure to do so may cause injury or a breakdown.

20. Do not touch the motor output spindle (including the key slot and gears) with a bare hand. Doing so may cause injury.

< Operation >

21. The stepping motor is not equipped with any protective device. Take protective measures using an over-current protective relay, a ground fault interrupter, a protective device from excess temperature, and an emergency stopping device. Failure to do so may cause injury or fire.

22. Do not touch the product for a period after the power is on or has been turned off, since the PM driver and stepping motor remain in the high temperature. Doing so may cause burns. Especially the temperature rises considerably of the stepping motor depending on the operating conditions. Use the motor on the condition so that its surface temperature becomes 100°C or under.

23. Stop the operation immediately when an emergency occurs. Failure to do so may cause an electric shock, injury or fire.

24. Do not change adjustment to an extreme, for such a change results in the unstable operation. Doing so may cause injury.

25. When conducting the trial operation, make the stepping motor fixed firmly, and confirm the operation by disconnecting with the mechanical system before connecting with it. Failure to do so may cause injury.

26. When the alarm has been activated, eliminate the cause and ensure the safety to resume operation. Failure to do so may cause injury.

27. When the electric power recovers after the momentary interruption, do not approach the devices because the system may re-start operation by itself. (Set the system so as to secure the safety even when it re-start on such occasion.) Failure to do so may cause injury.

28. Confirm that the electric power supply is all proper conforming to the specifications. Failure to do so may cause a trouble.

29. The brake mechanism of the motor with the electro-magnetic brake is to hold the movable section and the motor position. Do not use it as a safety measure, or doing so may cause the breakdown of the system.

30. Fix the key firmly when operating the motor with key individually. Failure to do so may cause injury.

< Maintenance services >

31. Be careful when performing maintenance services or inspection about the temperature which rises highly in the PM driver and stepping motor frame. Failure to do so may cause burns.

32. It is recommended to replace the electrolytic condenser of the PM driver with a new one for securing the preventive measure after using for 5 years, the expected life in the average 40°C. The expected life of the fuse and cooling fan motor is 10 years in the average 40°C. Thus, the periodical replacement is recommended.

33. Contact with us for repair. If the product is disassembled by the user, it may put it out of action.

< Transportation >

34. Handle the product with care during transportation so as to prevent from the danger such as a tumble or a turnover.

35. Do not hold with the cable or the motor spindle. Doing so may cause a trouble or injury.

< Retirement >

36. When scrapping the PM driver or stepping motor, treat it for the general industrial waste.

PROHIBITED

< Storage >

1. Avoid the place exposed to rain or water drops, or in an environment with hazardous gas or liquid for storing the product. Failure to do so may cause a trouble.

< Maintenance services >

2. Do not assemble or repair the product. Doing so may cause fire or an electric shock.

< General matters >

3. Do not remove the rating plate.

COMPULSORY

< Storage >

1. Store the product within the specified conservation temperature and humidity in the place not exposed to the sun beam.

2. If the PM driver has been stored for a long period (3 years or longer for a guide), consult with us. The capacitance may have decreased with the electrolytic condenser due to the long period storage, and it may cause a trouble.

< Operation >

3. Install an external emergency stop circuit to turn the power off for the instant halt of operation.

4. Put the product into operation in the specified ambient temperature and humidity.

< Transportation >

5. Excess loading of the product on the carrier may cause the load to fall in pieces. Follow the instructions given outside the package.

2

Phase

STEPPING DRIVER

The 2-phase Stepping System

Stepping System Configuration

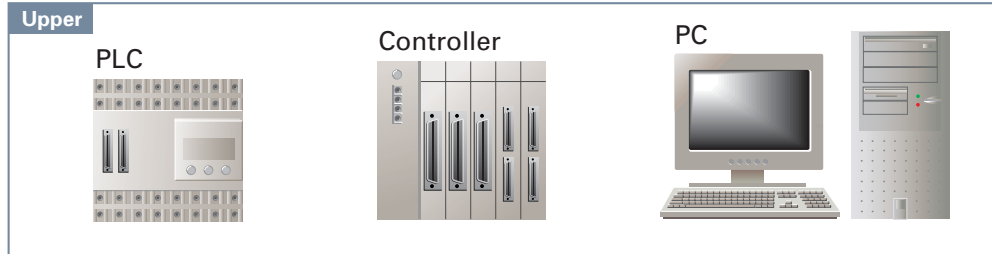

DRIVER
p5~p58

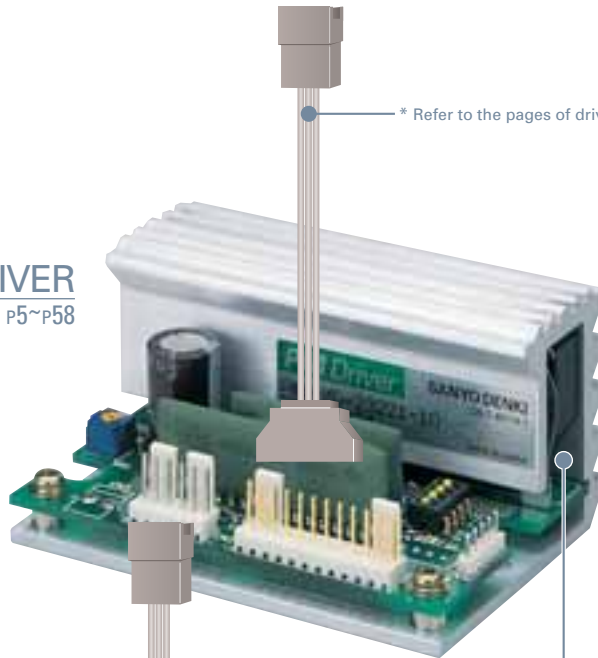

* Refer to the pages of driver for cable.

MOTOR
p59~p120



* Refer to the pages of driver for cable.



Options



With encoder

With harmonic gear

With brake

Damper

2-Phase Driver Area Chart

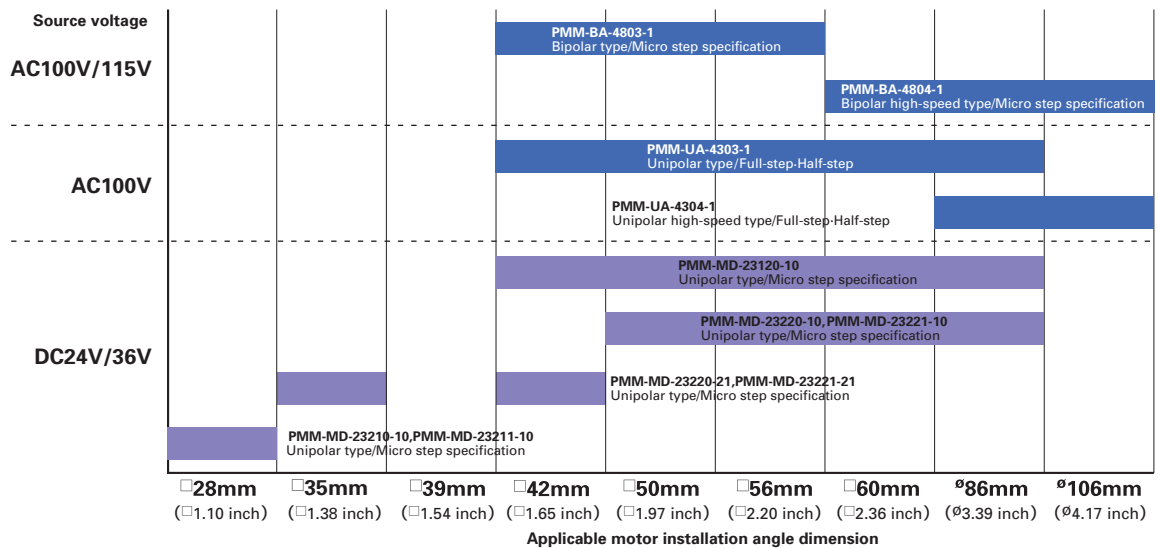

PMM-BA-4803-1



Source input
AC100/115V
Bipolar type
Micro step specification

P7~P16



PMM-BA-4804-1



Source input
AC100/115V
Bipolar high-speed type
Micro step specification

P7~P16

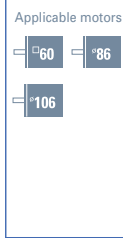

PMM-UA-4303-1



Source input
AC100V
Unipolar type
Full-step/Half-step

P17~P26

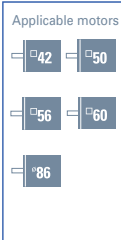

PMM-UA-4304-1



Source input
AC100V
Unipolar high-speed type
Full-step/Half-step

P17~P26

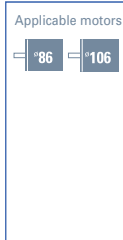

PMM-MD-23120-10



Source input
DC24V/36V
Unipolar type
Micro step specification

P45~P58

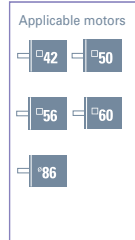

PMM-MD-23210-10
PMM-MD-23211-10



Source input
DC24V/36V
Unipolar type
Micro step specification

P27~P44

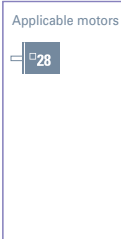

PMM-MD-23220-21
PMM-MD-23221-21



Source input
DC24V/36V
Unipolar type
Micro step specification

P27~P44

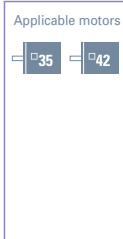

PMM-MD-23220-10
PMM-MD-23221-10



Source input
DC24V/36V
Unipolar type
Micro step specification

P27~P44

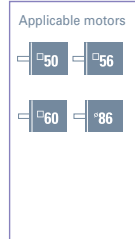

2-phase Stepping Driver



PMM-BA-4803-1 AC100V/115V Bipolar type

(Applicable motor rated current 1A/phase, 2A/phase)

Micro-step (200 X 1~250 divisions)
(Smooth operation and low vibration even at low speeds.)

● Applicable motor

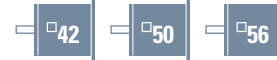

PMM-BA-4804-1 AC100V/115V Bipolar high-speed type

(Applicable motor rated current 4A/phase, 6A/phase)

Micro-step (200 X 1~250 divisions)
(Smooth operation and low vibration even at low speeds.)

● Applicable motor



Standard combined stepping motors

PMM-BA-4803-1

Dimensions of stepping motor	Stepping motor model number		Rated current [A/phase]	Holding torque [N·m(oz·in)]	Rotor inertia [x 10 ⁻⁴ kg·m ² (oz·in ²)]	Mass(Weight) [kg(lbs)]	Page
	Single shaft	Double shaft					
□42mm (1.65inch)	103H5205-4240	103H5205-4210	1	0.265(37.53)	0.036(0.20)	0.23(0.51)	69 Page
	103H5208-4240	103H5208-4210	1	0.39(55.23)	0.056(0.31)	0.29(0.64)	
	103H5209-4240	103H5209-4210	1	0.425(60.18)	0.062(0.34)	0.31(0.68)	
	103H5210-4240	103H5210-4210	1	0.51(72.22)	0.074(0.40)	0.37(0.82)	
□50mm(1.97inch)	103H6704-5040	103H6704-5010	2	0.52(73.6)	0.14(0.77)	0.55(1.21)	75 Page
□56mm (2.20inch)	103H7121-5040	103H7121-5010	2	0.39(55.2)	0.1(0.55)	0.47(1.04)	79 Page
	103H7123-5040	103H7123-5010	2	0.83(117.5)	0.21(1.15)	0.65(1.43)	
	103H7126-5040	103H7126-5010	2	1.27(179.8)	0.36(1.97)	0.98(2.16)	

• For information about the general specifications and dimensions of each stepping motor, refer to its page.

PMM-BA-4804-1

Dimensions of stepping motor	Stepping motor model number		Rated current [A/phase]	Holding torque [N·m(oz·in)]	Rotor inertia [x 10 ⁻⁴ kg·m ² (oz·in ²)]	Mass(Weight) [kg(lbs)]	Page
	Single shaft	Double shaft					
□60mm (2.36inch)	103H7821-1740	103H7821-1710	4	0.88(124.6)	0.275(1.50)	0.6(1.32)	87 Page
	103H7822-1740	103H7822-1710	4	1.37(194.0)	0.4(2.19)	0.77(1.70)	
	103H7823-1740	103H7823-1710	4	2.7(382.3)	0.84(4.59)	1.34(2.95)	
ø86mm (3.39inch)	103H8221-5241	103H8221-5211	6	2.74(388.0)	1.45(7.93)	1.5(3.31)	91 Page
	103H8222-5241	103H8222-5211	6	5.09(720.8)	2.9(15.86)	2.5(5.51)	
	103H8223-5241	103H8223-5211	6	7.44(1053.6)	4.4(24.06)	3.5(7.72)	
ø106mm (2.36inch)	103H89222-5241	103H89222-5211	6	13.2(1869.2)	14.6(79.83)	7.5(16.53)	97 Page
	103H89223-5241	103H89223-5211	6	19(2690.5)	22(120.28)	10.5(23.15)	

• For information about the general specifications and dimensions of each stepping motor, refer to its page.

Specifications of PM Driver

Item		PMM-BA-4803-1	PMM-BA-4804-1	
Basic specifications	Input source	Single phase AC 100V/115V+10, -15% 50/60Hz		
	Source current	3A	8A	
	Rated current	2A/phase (Changeable to 1A/phase, refer to Page 11)	6A/phase (Changeable to 4A/phase, refer to Page11)	
	Environment	Operating ambient temperature	0~+50°C	
		Conservation temperature	-20~+70°C	
		Operating ambient humidity	35~85%RH (no condensation)	
		Conservation humidity	10~90%RH (no condensation)	
		Vibration resistance	4.9m/s ² Frequency range 10~55Hz, Direction: along X, Y and Z axes, for 2 hours each.	
		Impact resistance	Considering the NDS-C-0110 standard section 3.2.2 division "C", not influenced.	
		Withstand voltage	Not influenced when AC100V is applied between power input terminal and cabinet for one minute.	
Insulation resistance	10MΩ MIN. when measured with DC500V megohmmeter between input terminal and cabinet.			
Mass(Weight)	2kg(4.41lbs)	4kg(8.82lbs)		
Function	Protection function	Against PM driver overheat		
	Selection, setting function	Pulse input mode selection– DIP switches enables selection of Pulse and direction and 2-input mode Resolution setting– Combination of two rotary switches enables 240 divisions ranging from 1~240 resolution Micro step selection– External signal input (S, SEL) enables selection of the DIP switch driven micro step or the rotary switch driven micro step. Power down, power low selection– Current value of the stepping motor can be selected when power signal is input. Automatic current down selection– Automatic current down function can be selected. Driving current switch setting– The rotary switch enables to set driving current of the stepping motor from rated current to 0%		
	LED indicator	Power supply monitor, phase origin monitor, pulse monitor, alarm monitor.		
I/O signals	Signal Name (Brevity code)	Silk-screen printing		
	CW pulse Input signal (CW)	CW+	In the 2-input mode, inputs driving pulses to rotate in CW direction.	
		CW-		
	(CK)		In the Pulse and direction mode, inputs driving pulse train to rotate the step motor rotation. Photo coupler input method, input resistance 330Ω Input signal voltage: H = 4.0 to 5.5V, L = 0 to 0.5V MAX. input frequency:100kpulse/s	
	CCW pulse Input signal (CCW)	CCW+	In the 2-input mode, inputs driving pulses to rotate in CCW direction. Pulse and direction	
		CCW-		
	(U/D)		In the pulse and direction mode, inputs rotation direction signals to the stepping motor. Internal photo couplerON: CW direction. Internal photo couplerOFF: CCW direction. Photo coupler input method, input resistance 330Ω Input signal voltage: H = 4.0 to 5.5V, L = 0 to 0.5V MAX. input frequency:100kpulse/s	
	Power down input signal (PD)	PD + PD -	Inputs PD signal to turn off the current that flows through the stepping motor. (Capable to change by the DIP switch to power low function.) PD input signal ON (Internal photo coupler ON): Power down function is enabled. PD input signal OFF (Internal photo coupler OFF): Power down function is disabled. Photo coupler input method, input resistance 330Ω, Input signal voltage: H = 4.0 to 5.5V, L = 0 to 0.5V	
Step angle setting selection input (S.SEL)	S.SEL+ S.SEL-	Input S.SEL signal to select step angle setting method. The open position determines to be the mode 1. Internal photo coupler ON: Mode 2 method step angle setting. (Internal rotary switch setting.) Internal photo coupler OFF: Mode 1 method step angle setting. (Internal DIP switch setting.) Photo coupler input method, input resistance 330Ω Input signal voltage: H = 4.0 to 5.5V, L = 0 to 0.5V		
Alarm output (AL)	AL1	Outputs signal when either alarm circuit is activated in the PM driver.		
	AL2	When this signal is generated, the stepping motor is made in the de-excited state. Relay contact output (at normal open), contact capacity: DC24V, 0.5A MAX. or AC120V, 0.5A MAX.		

- The CW direction indicated above is the rotation direction of the stepping motor in clockwise as facing to the output shaft side (flange side). The CCW direction is the same in counter-clockwise.

Operation, Connection, and Function

● Input circuit configuration (CW, CCW) --- PMM-BA-4803-1 and PMM-BA-4804-1 in common

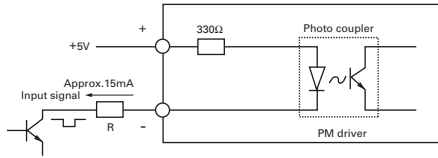

- Pulse duty 50% MAX.
- When the crest value of the input signal is 5V, the external limit resistance R must be 0Ω .
When the crest value of the input signal exceeds 5V, use the external limit resistance R to limit the input current to approximately 15mA.

Input signal specifications

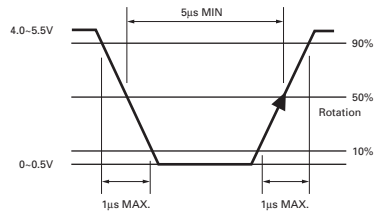

Timing of command pulse

- 2-input mode (CW, CCW)

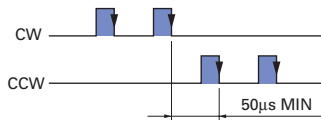

- The internal photo coupler turns ON within the ■ and, at its falling edge to OFF, the internal circuit (stepping motor) is activated.
- When applying the pulse to CW, turn OFF the CCW side internal photo coupler.
- When applying the pulse to CCW, turn OFF the CW side internal photo coupler.

- Pulse and direction mode (CK, U/D)

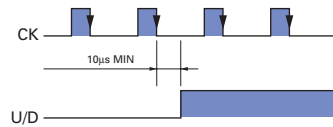

- The internal photo coupler turns ON within the ■ and, at CK side falling edge to OFF, the internal circuit (stepping motor) is activated.
- Switching of U/D input signal shall be made when CK side internal photo coupler is OFF.

● Input circuit configuration (PD, S. SEL) --- PMM-BA-4803-1 and PMM-BA-4804-1 in common

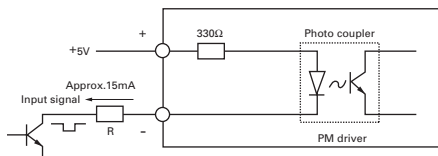

- When the crest value of the input signal is 5V, the external limit resistance R must be 0Ω .
When the crest value of the input signal exceeds 5V, use the external limit resistance R to limit the input current to approximately 15mA.

● Output circuit configuration (AL) --- PMM-BA-4803-1 and PMM-BA-4804-1 in common

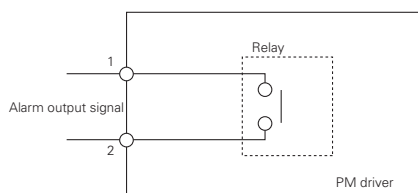

- Alarm output signal
Contact mode: Relay contact output (Normally open)
Contact capacity: DC24V, 0.5A MAX. or AC120V, 0.5A MAX.

Operation, Connection, and Function

● PM driver component names and function selection/setting
PMM-BA-4803-1 PMM-BA-4804-1

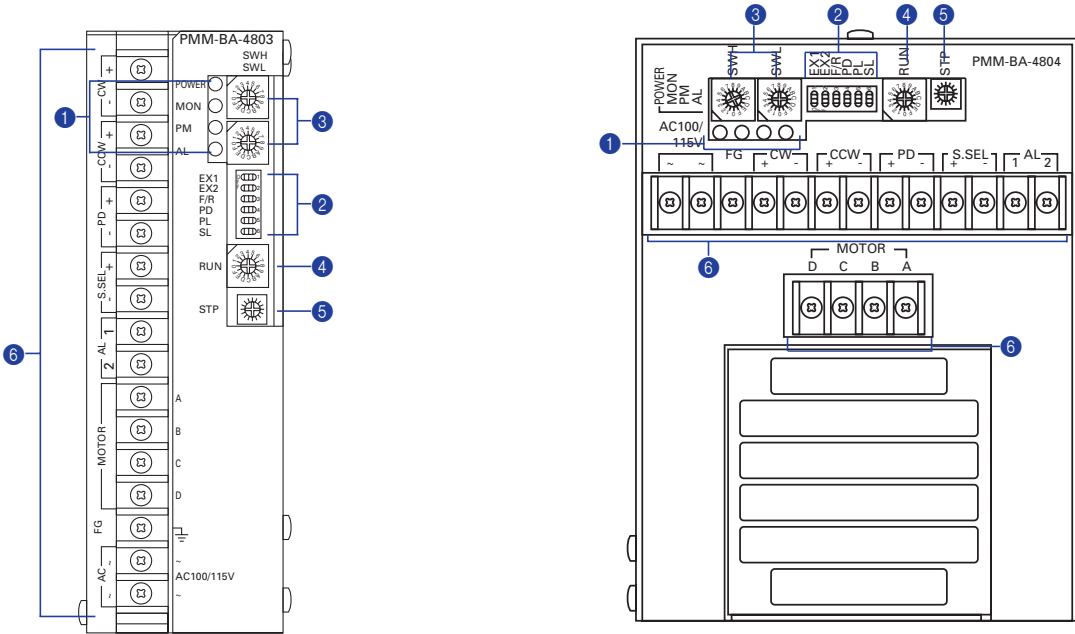

① Monitor indication (POWER, MON, PM, AL) --- PMM-BA-4803-1 and PMM-BA-4804-1 in common

Indication	Color	State
POWER	Green	This LED illuminates when internal power supply is ON.
MON	Green	This LED illuminates when exciting magnetic phase is at the origin (when power is ON). At the 1 division (or 1.8°/step) setting, illuminates once for every 4 pulses. At the 2 divisions (or 0.9°/step) setting, illuminates once for every 8 pulses. Timing of MON indicator illumination (At the 1 division) CW pulse CCW pulse MON • At mark, inside photo coupler "ON" MON illuminates.
PM	Green	This LED illuminates when input pulse is applied
AL	Red	When the element temperature becomes 80°C MIN, in the PM driver, heat protective alarm circuit for the internal elements is activated and this LED illuminates. As the alarm circuit is activated, the wire-wound current is shut and the stepping motor becomes in a de-excited state. Simultaneously, the alarm output relay is closed to generate the output signal. When the element temperature falls back to 80°C MAX, the alarm is automatically released and the current flows into the stepping motor. When the alarm is ON, turn the main power OFF before the automatic recovery system works, and take measures to reduce heat generation such as forced cooling to the PM driver enclosure

② Function selection DIP switch pack (EX1, EX2, F/R, PD, PL, SL) --- PMM-BA-4803-1 and PMM-BA-4804-1 in common

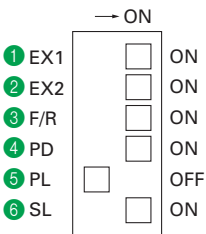

- The factory setting is shown in the figure above.
- Turn off the power supply to the PM driver before changing DIP switch setting.

① ② EX1, EX2 (Step angle setting selection)

Set the step angle (mode 1)

EX1	EX2	Step Angle
OFF	ON	Basic step angle x 1/1 (1.8°/pulse)
ON	ON	Basic step angle x 1/2 (0.9°/pulse)
ON	OFF	Basic step angle x 1/4 (0.45°/pulse)
OFF	OFF	Basic step angle x 1/5 (0.36°/pulse)

③ F/R (Pulse-input mode selection)

Select the pulse-input mode.

F/R	Pulse-input mode
ON	2-input mode (CW, CCW)
OFF	Pulse and direction mode (CK, U/D)

④ ⑤ PD, PL (Power-down and power-low selection)

Select stepping motor current value when power down signal is input.

PD	PL	Stepping motor winding wire current
OFF	ON	Sets current value by the stepping motor current controller (STP), when not operating. (Power down)
ON	OFF	O/A (Power Off)

- The factory setting of the current value by the current adjustment controller (STP) is at about 50% of stepping motor current value on operation. Adjustment by customer is not supported.

⑥ SL (Auto current down selection)

Select Auto current down function selection.

SL	Auto current down
ON	Approx 50% of current rating when stopped
OFF	100% of current rating when stopped

- The temperature increase in the motor driver can be controlled by setting SL to On (approx. 50% of the rated current).
- The output torque when SL is On (approx. 50% of the rated current) is approx. 50% of the that when SL is Off (100% of the rated current).

PMM-BA-4803
PMM-BA-4804

PMM-UA-4303
PMM-UA-4304

PMM-MD-2316-10/2321-10
PMM-MD-2320-21/2321-21
PMM-MD-2320-10/2321-10

PMM-MD-23120

Operation, Connection, and Function

③ Step angle setting rotary switch (SWH, SWL) --- PMM-BA-4803-1 and PMM-BA-4804-1 in common

Capable to set step angle by the rotary switches SWH and SWL (mode 2).

Fundamental Formula

Step angle = $n/N \times$ Basic step angle of the stepping motor.

n: Required division number setting (capable to set by the rotary switches).

N: Basic division number (set at 240 at the factory).

- Factory setting is 0.09°/pulse (set SWH at "0", SWL at "C").
- Step angle setting by the mode 2 is effective by turning on the S.SEL input signal (internal photo coupler on).

Setting method of the rotary switch.

The rotary switches are of the hexadecimal code setting type.

(Example) To drive the stepping motor with the basic step angle of 1.8° at the rate of stepping angle of 0.36°.

$$0.36^\circ = n/240 \times 1.8^\circ \quad (n = 48 \text{ (by decimal system)})$$

n : 48 (by decimal system) equals to 30 by hexadecimal system.

Therefore, 0.36°/pulse is obtainable by setting the rotary switch "SWH" at 3, and "SWL" 0

④ Operating-current selection switch (RUN)

Select operating current value to stepping motor.

PMM-BA-4803-1

Scale	0	1	2	3	4	5	6	7
Stepping motor current (A/Phase)	2.0	1.9	1.7	1.6	1.4	1.3	1.2	1.0
Scale	8	9	A	B	C	D	E	F
Stepping motor current (A/Phase)	0.9	0.8	0.6	0.5	0.3	0.2	0.1	0

- The factory setting is "0".
Select setting depending on applied motors.

PMM-BA-4804-1

Scale	0	1	2	3	4	5	6	7
Stepping motor current (A/Phase)	6.0	5.7	5.1	4.8	4.2	3.9	3.6	3.0
Scale	8	9	A	B	C	D	E	F
Stepping motor current (A/Phase)	2.7	2.4	1.8	1.5	0.9	0.6	0.3	0

- The factory setting is "0".
Select setting depending on applied motors.

⑤ Current adjustment controller during halt (STP) --- PMM-BA-4803-1 and PMM-BA-4804-1 in common

Adjust current of stepping motor during halt in the range from rated current to 0% when automatic current reduction function is operating.

Factory setting is set at 50% of rated current and customers controller (STP) adjustment is not supported.

⑥ Terminal block (TB) --- PMM-BA-4803-1 and PMM-BA-4804-1 in common

Connects I/O signals, single phase AC power supply, and the stepping motor power cord.

● External wiring diagram --- PMM-BA-4803-1 and PMM-BA-4804-1 in common

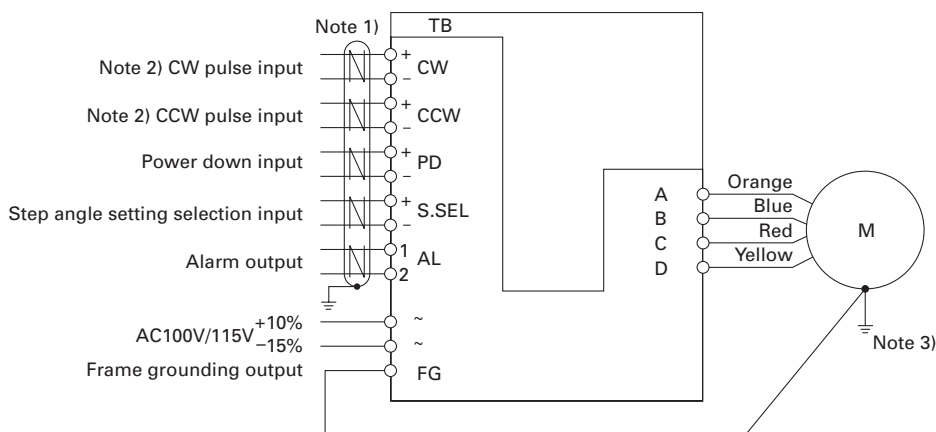

Note 1) Use twisted pair shielded cables.

Note 2) Capable to select by the function selection switch F/R for "2-input mode (CW and CCW input mode)" or "Pulse and direction mode (CK, U/D)".

Note 3) Ground the flange of the stepping motor by fastening the grounding wire together with the mounting screw. The grounding shall be made at a single point.

Dimensions [Unit:mm(inch)]

PMM-BA-4803-1

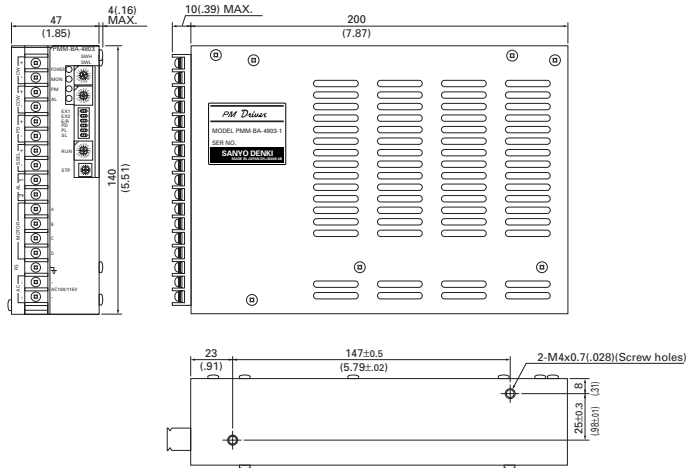

PMM-BA-4804-1

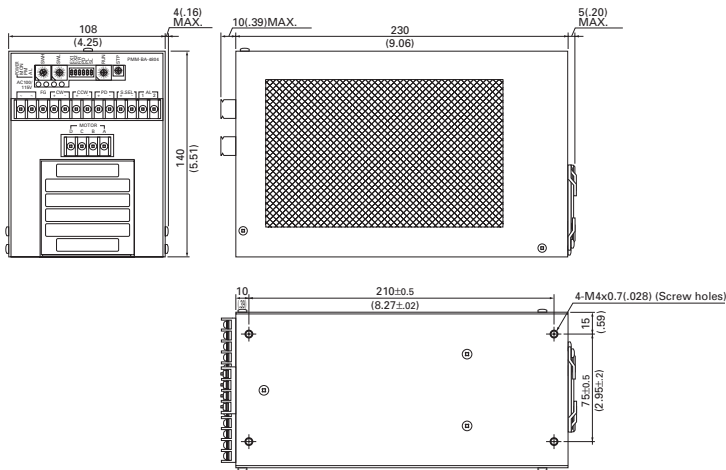

Mounting direction and mounting position

PMM-BA-4803-1

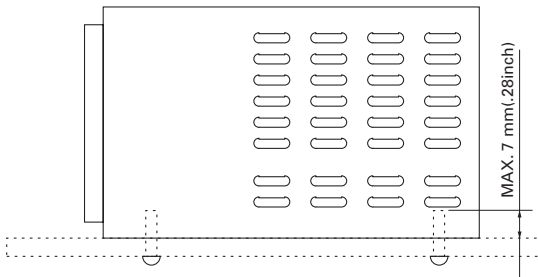

PMM-BA-4804-1

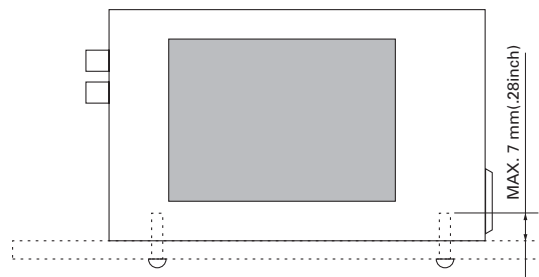

- Mount the PM driver as it stands upright.
- Use the mounting holes in the bottom of the PM driver with M4 screws as shown in the figure. (No mounting hardware is required.)
- The length of the screws projecting inward the driver enclosure shall be shorter than 7mm(0.28inch).

PMM-BA-4803
PMM-BA-4804

PMM-UA-4303
PMM-UA-4304

PMM-UD-2310-10/2321-10
PMM-UD-2320-21/2321-21
PMM-UD-2320-10/2321-10

PMM-UD-23120

Pulse Rate-Torque Characteristics/Pulse Rate-Power Current Characteristics

fs: No load maximum starting pulse rate ■ 1-division is specified ■ 2-division is specified

PMM-BA-4803-1

● **103H5205-42** □ □ : **100V**

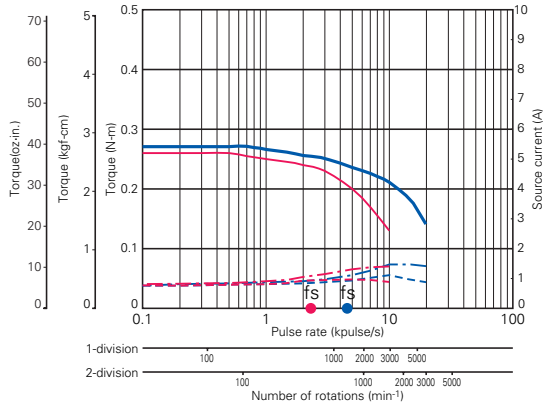

Source voltage: AC100V, Operating current:1A/phase
 — Pull-Out torque [$JL_1=0.94 \times 10^{-4} \text{kg}\cdot\text{m}^2$ (5.14 oz-in²) Use the rubber coupling]
 - - - Source current (TL=MAX), - - - Source current (TL=0)

● **103H5208-42** □ □ : **100V**

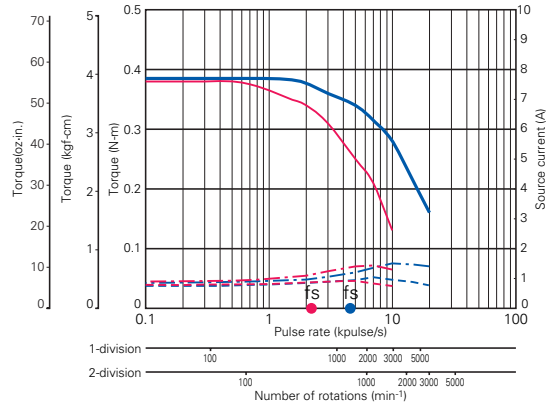

Source voltage: AC100V, Operating current:1A/phase
 — Pull-Out torque [$JL_1=0.94 \times 10^{-4} \text{kg}\cdot\text{m}^2$ (5.14 oz-in²) Use the rubber coupling]
 - - - Source current (TL=MAX), - - - Source current (TL=0)

● **103H5209-42** □ □ : **100V**

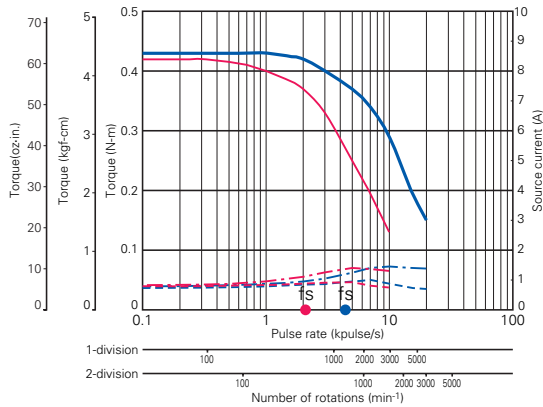

Source voltage: AC100V, Operating current:1A/phase
 — Pull-Out torque [$JL_1=0.94 \times 10^{-4} \text{kg}\cdot\text{m}^2$ (5.14 oz-in²) Use the rubber coupling]
 - - - Source current (TL=MAX), - - - Source current (TL=0)

● **103H5210-42** □ □ : **100V**

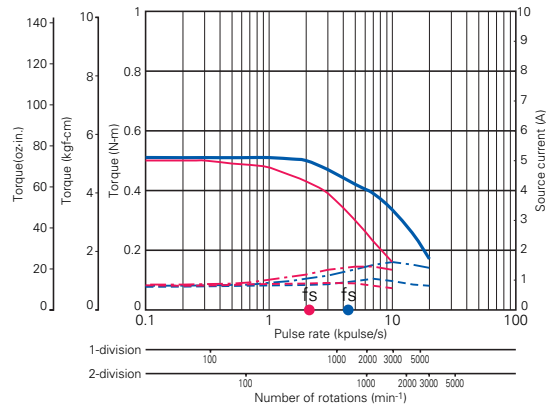

Source voltage: AC100V, Operating current:1A/phase
 — Pull-Out torque [$JL_1=0.94 \times 10^{-4} \text{kg}\cdot\text{m}^2$ (5.14 oz-in²) Use the rubber coupling]
 - - - Source current (TL=MAX), - - - Source current (TL=0)

● **103H6704-50** □ □ : **100V**

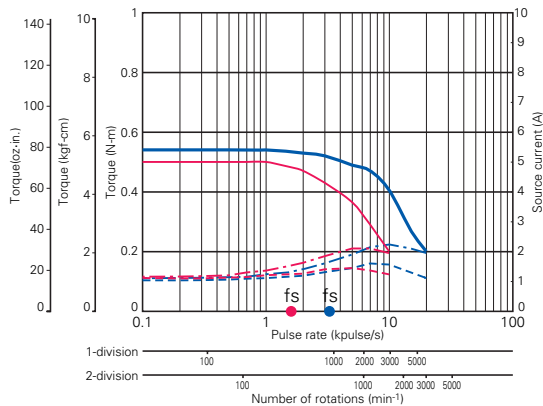

Source voltage: AC100V, Operating current: 2A/phase
 — Pull-Out torque [$JL_1=0.94 \times 10^{-4} \text{kg}\cdot\text{m}^2$ (5.14 oz-in²) Use the rubber coupling]
 - - - Source current (TL=MAX), - - - Source current (TL=0)

● **103H7121-50** □ □ : **100V**

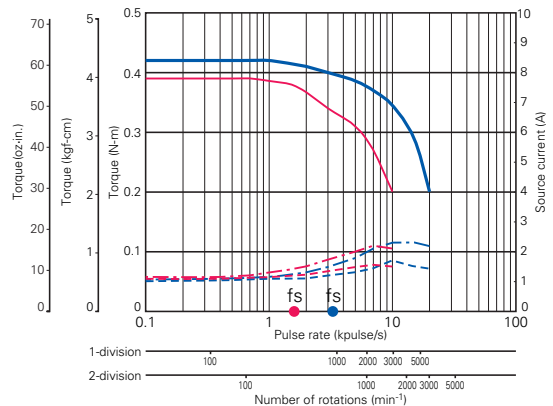

Source voltage: AC100V, Operating current: 2A/phase
 — Pull-Out torque [$JL_1=0.94 \times 10^{-4} \text{kg}\cdot\text{m}^2$ (5.14 oz-in²) Use the rubber coupling]
 - - - Source current (TL=MAX), - - - Source current (TL=0)

Pulse Rate-Torque Characteristics/Pulse Rate-Power Current Characteristics

fs: No load maximum starting pulse rate ■ 1-division is specified ■ 2-division is specified

PMM-BA-4803-1

● 103H7123-50 □ □ : 100V

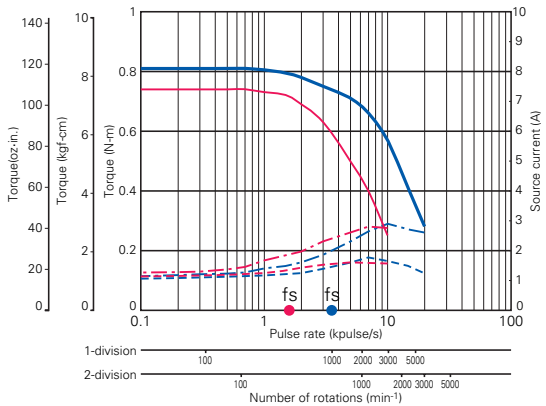

Source voltage: AC100V, Operating current : 2A/phase
 — Pull-Out torque ($J_{L1}=2.6 \times 10^{-4} \text{kg}\cdot\text{m}^2$ (14.22 oz-in²) Use the rubber coupling)
 - - - Source current (TL=MAX), - - - Source current (TL=0)

● 103H7126-50 □ □ : 100V

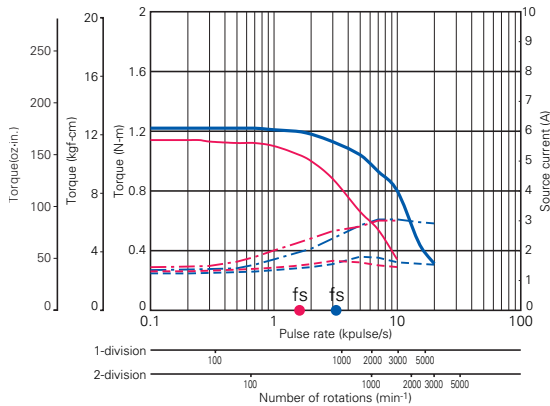

Source voltage: AC100V, Operating current : 2A/phase
 — Pull-Out torque ($J_{L1}=2.6 \times 10^{-4} \text{kg}\cdot\text{m}^2$ (14.22 oz-in²) Use the rubber coupling)
 - - - Source current (TL=MAX), - - - Source current (TL=0)

PMM-BA-4804-1

● 103H7821-17 □ □ : 100V

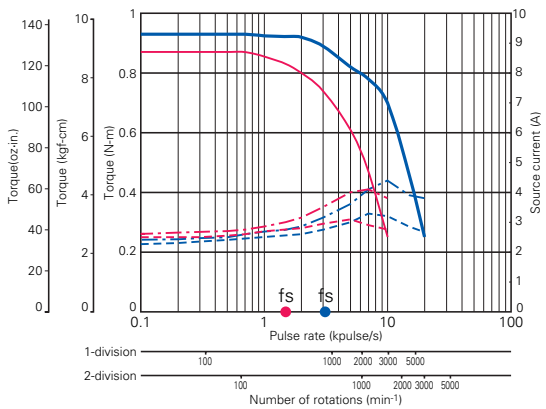

Source voltage: AC100V, Operating current : 4A/phase
 — Pull-Out torque ($J_{L1}=2.6 \times 10^{-4} \text{kg}\cdot\text{m}^2$ (14.22 oz-in²) Use the rubber coupling)
 - - - Source current (TL=MAX), - - - Source current (TL=0)

● 103H7822-17 □ □ : 100V

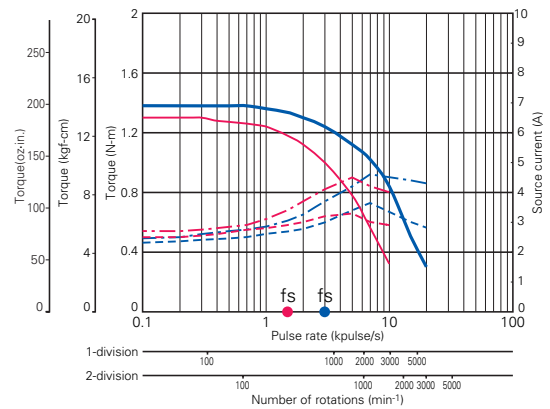

Source voltage: AC100V, Operating current : 4A/phase
 — Pull-Out torque ($J_{L1}=2.6 \times 10^{-4} \text{kg}\cdot\text{m}^2$ (14.22 oz-in²) Use the rubber coupling)
 - - - Source current (TL=MAX), - - - Source current (TL=0)

● 103H7823-17 □ □ : 100V

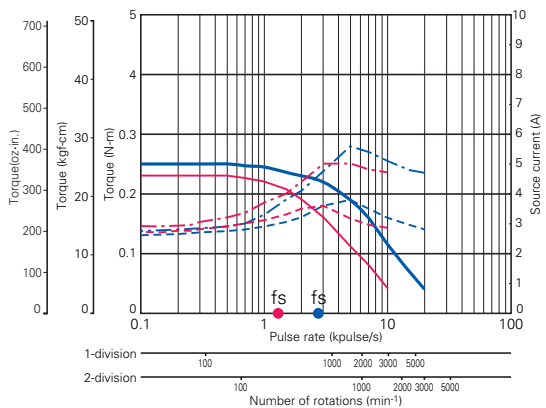

Source voltage: AC100V, Operating current : 4A/phase
 — Pull-Out torque ($J_{L1}=15.3 \times 10^{-4} \text{kg}\cdot\text{m}^2$ (83.65 oz-in²) Use the rubber coupling)
 - - - Source current (TL=MAX), - - - Source current (TL=0)

● 103H8221-52 □ □ : 100V

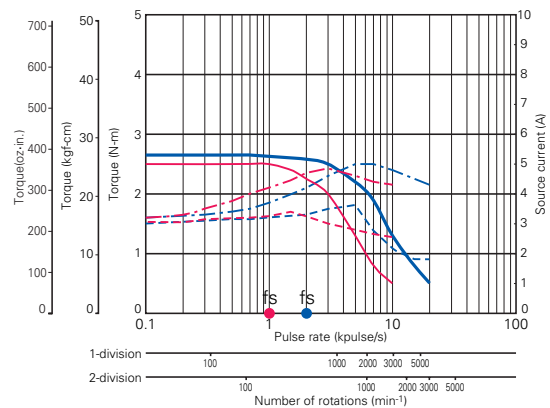

Source voltage: AC100V, Operating current : 6A/phase
 — Pull-Out torque ($J_{L1}=15.3 \times 10^{-4} \text{kg}\cdot\text{m}^2$ (83.65 oz-in²) Uses rubber coupling)
 - - - Source current (TL=MAX), - - - Source current (TL=0)

PMM-BA-4803
PMM-BA-4804

PMM-UA-4303
PMM-UA-4304

PMM-UD-3216-10/3221-10
PMM-UD-3220-21/3221-21
PMM-UD-3220-10/3221-10

PMM-UD-23120

Pulse Rate-Torque Characteristics/Pulse Rate-Power Current Characteristics

fs: No load maximum starting pulse rate ■ 1-division is specified ■ 2-division is specified

PMM-BA-4804-1

● 103H8222-52 □ □ : 100V

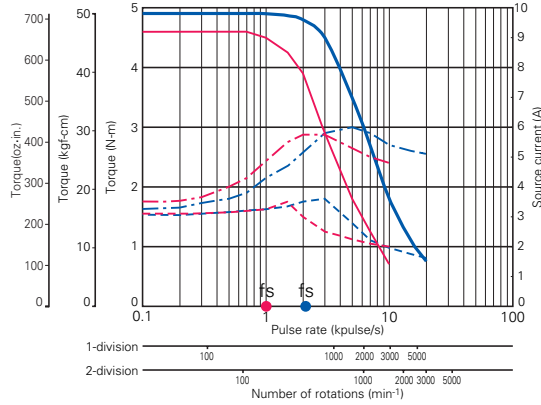

Source voltage: AC100V, Operating current : 6A/phase
 — Pull-Out torque [$J_{L1}=15.3 \times 10^{-4} \text{kg}\cdot\text{m}^2$ (83.65 oz-in²) Use the rubber coupling]
 - - - Source current (TL=MAX), - - - Source current (TL=0)

● 103H8223-52 □ □ : 100V

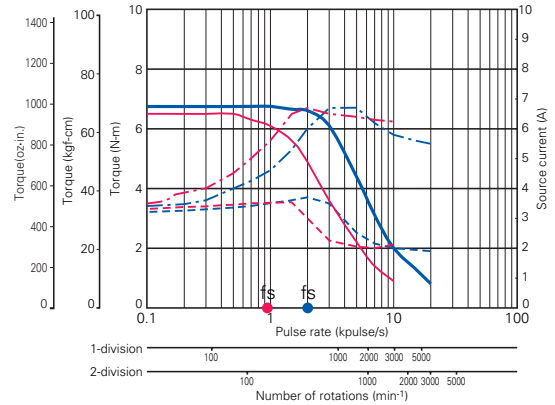

Source voltage: AC100V, Operating current : 6A/phase
 — Pull-Out torque [$J_{L1}=15.3 \times 10^{-4} \text{kg}\cdot\text{m}^2$ (83.65 oz-in²) Use the rubber coupling]
 - - - Source current (TL=MAX), - - - Source current (TL=0)

● 103H89222-52 □ □ : 100V

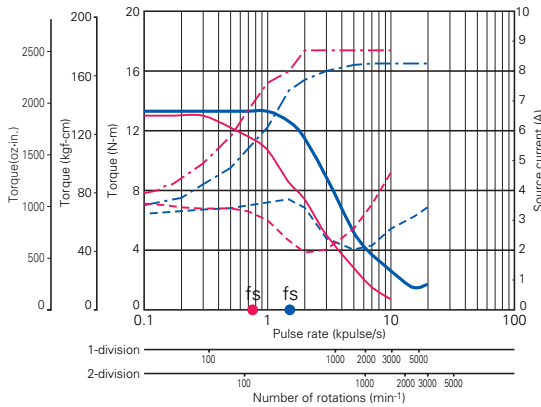

Source voltage: AC100V, Operating current : 6A/phase
 — Pull-Out torque [$J_{L1}=43 \times 10^{-4} \text{kg}\cdot\text{m}^2$ (235.10 oz-in²) Use the rubber coupling]
 - - - Source current (TL=MAX), - - - Source current (TL=0)

● 103H89223-52 □ □ : 100V

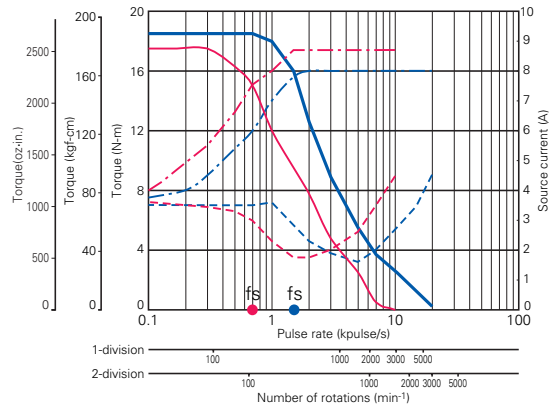

Source voltage: AC100V, Operating current : 6A/phase
 — Pull-Out torque [$J_{L1}=43 \times 10^{-4} \text{kg}\cdot\text{m}^2$ (235.10 oz-in²) Use the rubber coupling]
 - - - Source current (TL=MAX), - - - Source current (TL=0)

Options

● Terminal board cover

PMM-BA-4803-1

Model No.	PM-AP-021
-----------	-----------

PMM-BA-4804-1

Model No.	PM-AP-014
	PM-AP-018



2
Phase

- PMM-BA-4803
PMM-BA-4804
- PMM-UA-4303
PMM-UA-4304
- PMM-MD-2320-10/2321-10
PMM-MD-2320-21/2321-21
PMM-MD-2320-10/2321-10
- PMM-MD-23120

2-phase Stepping Driver



PMM-UA-4303-1

AC100V Unipolar type

(Applicable motor rated current 1.2A/phase, 2A/phase)

Full-step / Half-step

(200 x 1 division) (200 x 2 division)

● Applicable motor



PMM-UA-4304-1

AC100V Unipolar high-speed type

(Applicable motor rated current 4A/phase)

Full-step / Half-step

(200 x 1 division) (200 x 2 division)

● Applicable motor



Standard combined stepping motors

PMM-UA-4303-1

Dimensions of stepping motor	Stepping motor model number		Rated current [A/phase]	Holding torque [N·m(oz·in)]	Rotor inertia [x 10 ⁻⁴ kg·m ² (oz·in ²)]	Mass(Weight) [kg(lbs)]	Page
	Single shaft	Double shaft					
□42mm (1.65inch)	103H5205-0440	103H5205-0410	1.2	0.2(28.32)	0.036(0.20)	0.23(0.51)	69 Page
	103H5208-0440	103H5208-0410	1.2	0.3(42.48)	0.056(0.31)	0.29(0.64)	
	103H5209-0440	103H5209-0410	1.2	0.32(45.31)	0.062(0.34)	0.31(0.68)	
	103H5210-0440	103H5210-0410	1.2	0.37(52.39)	0.074(0.40)	0.37(0.82)	
□50mm (1.97inch)	103H6701-0440	103H6701-0410	2	0.28(39.6)	0.057(0.31)	0.35(0.77)	75 Page
	103H6703-0440	103H6703-0410	2	0.49(69.4)	0.118(0.65)	0.5(1.10)	
	103H6704-0440	103H6704-0410	2	0.52(73.6)	0.14(0.77)	0.55(1.21)	
□56mm (2.20inch)	103H7121-0440	103H7121-0410	2	0.39(55.2)	0.1(0.55)	0.47(1.04)	79 Page
	103H7123-0440	103H7123-0410	2	0.83(117.5)	0.21(1.15)	0.65(1.43)	
	103H7124-0440	103H7124-0410	2	0.98(138.8)	0.245(1.34)	0.8(1.76)	
	103H7126-0440	103H7126-0410	2	1.27(179.8)	0.36(1.97)	0.98(2.16)	
□60mm (2.36inch)	103H7821-0440	103H7821-0410	2	0.78(110.5)	0.275(1.50)	0.6(1.32)	87 Page
	103H7822-0440	103H7822-0410	2	1.17(165.7)	0.4(2.19)	0.77(1.70)	
	103H7823-0440	103H7823-0410	2	2.1(297.4)	0.84(4.59)	1.34(2.95)	
ø86mm (3.39inch)	103H8221-0441	103H8221-0411	2	2.15(304.5)	1.45(7.93)	1.5(3.31)	91 Page
	103H8222-0441	103H8222-0411	2	4.13(584.8)	2.9(15.86)	2.5(5.51)	
	103H8223-0441	103H8223-0411	2	6.27(887.9)	4.4(24.06)	3.5(7.72)	

• For information about the general specifications and dimensions of each stepping motor, refer to its page.

PMM-UA-4304-1

Dimensions of stepping motor	Stepping motor model number		Rated current [A/phase]	Holding torque [N·m(oz·in)]	Rotor inertia [x 10 ⁻⁴ kg·m ² (oz·in ²)]	Mass(Weight) [kg(lbs)]	Page
	Single shaft	Double shaft					
ø86mm (3.39inch)	103H8221-0941	103H8221-0911	4	2.15(304.5)	1.45(7.93)	1.5(3.31)	91 Page
	103H8222-0941	103H8222-0911	4	4.13(584.8)	2.9(15.86)	2.5(5.51)	
	103H8223-0941	103H8223-0911	4	6.27(887.9)	4.4(24.06)	3.5(7.72)	
ø106mm (4.17inch)	103H89222-0941	103H89222-0911	4	10.8(1529.4)	14.6(79.83)	7.5(16.53)	97 Page
	103H89223-0941	103H89223-0911	4	15.5(2194.9)	22(120.28)	10.5(23.15)	

• For information about the general specifications and dimensions of each stepping motor, refer to its page.

Specifications of PM Driver

Item		PMM-UA-4303-1	PMM-UA-4304-1	
Basic specifications	Input source	Single phase AC 100V+10,-15% 50/60Hz±3Hz		
	Source current	3A	5A	
	Rated current	2A/phase (Changeable to 1.2A/phase, refer to Page 20)	4A/phase	
	Environment	Operating ambient temperature	0~+50°C	
		Conservation temperature	-20~+70°C	
		Operating ambient humidity	35~85%RH (no condensation)	
		Conservation humidity	10~90%RH (no condensation)	
		Vibration resistance	4.9m/s ² Frequency range 10~55Hz, Direction: along X, Y and Z axes, for 2 hours each.	
		Impact resistance	Considering the NDS-C-0110 standard section 3.2.2 division "C", not influenced.	
		Withstand voltage	Not influenced when AC 1000V is applied between power input terminal and cabinet for one minute.	
Insulation resistance	10MΩ MIN. when measured with DC500V megohmmeter between input terminal and cabinet.			
Mass(Weight)	0.6kg(1.32lbs)	3kg(6.61lbs)		
Function	Protection function	Against PM driver overheat		
	Selection, setting function	Exciting mode selection-- DIP switches enables selection of Full-step and Half-step mode. Automatic current down selection-- Automatic current down function can be selected. Driving current switch setting- DIP switch enables setting driving current of the Stepping Motor. PMM-UA-4303-1 --- 1A/phase, 1.2A/phase, 1.5A/phase, 1.8A/phase, 2A/phase 5 selections. PMM-UA-4304-1 --- 3.6A/phase, 4A/phase, 4.6A/phase, 5A/phase, 4 selections.		
	LED indicator	Alarm monitor.		
I/O signals	Signal Name (Brevity code)	Silk-screen printing		
	CW pulse Input signal (CW)	CW+ CW-	Inputs driving pulses to rotate in CW direction. Photo coupler input method, input resistance 150Ω Input signal voltage: H = 4.0 to 5.5V, L = 0 to 0.5V Maximum input frequency:20kpulse/s	
	CCW pulse Input signal (CCW)	CCW+ CCW-	Input driving pulses to rotate in CCW direction. Photo coupler input method, input resistance 150Ω Input signal voltage: H = 4.0 to 5.5V, L = 0 to 0.5V Maximum input frequency:20kpulse/s	
	Alarm output (AL)	AL1 AL2	Outputs signal when either alarm circuit is activated in the PM driver. When this signal is generated, the stepping motor is made in the de-excited state. Photocoupler open collector output (at normal open), Output specification : Veco = 30VDC MAX. Ic = 5mA MAX.	

- The CW direction indicated above is the rotation direction of the stepping motor in clockwise as facing to the output shaft side (flange side). The CCW direction is the same in counter-clockwise.

PMM-BA-4803
PMM-BA-4804

PMM-UA-4303
PMM-UA-4304

PMM-UD-3216-10/2221-10
PMM-UD-3220-21/2221-21
PMM-UD-3220-10/2221-10

PMM-UD-23120

Operation, Connection, and Function

● Input circuit configuration (CW, CCW) --- MM-UA-4303-1 and PMM-UA-4304-1 in common

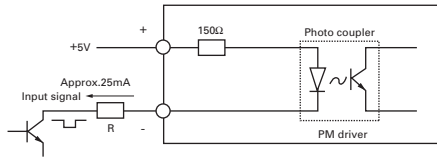

- Pulse duty 50% MAX.
- When the crest value of the input signal is 5V, the external limit resistance R must be 0Ω .
When the crest value of the input signal exceeds 5V, use the external limit resistance R to limit the input current to approximately 25mA.

Input signal specifications

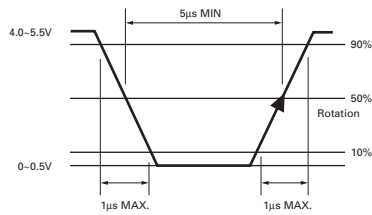

Timing of the command pulse 2-input mode (CW, CCW)

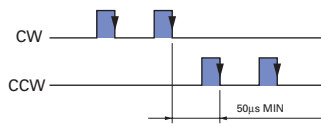

- The internal photo coupler turns ON within the and, at its falling edge to OFF, the internal circuit (stepping motor) is activated.
- When applying the pulse to CW, turn OFF the CCW side internal photo coupler.
- When applying the pulse to CCW, turn OFF the CW side internal photo coupler.

● Output circuit configuration (AL) --- PMM-UA-4303-1 and PMM-UA-4304-1 in common

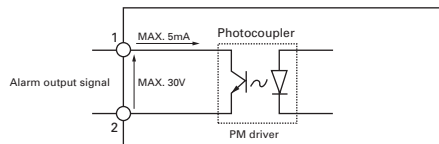

- Alarm output signal
Contact mode: Photocoupler open collector output
Contact capacity: 30V DC 5mA MAX.

Operation, Connection, and Function

PM driver component names
PMM-UA-4303-1

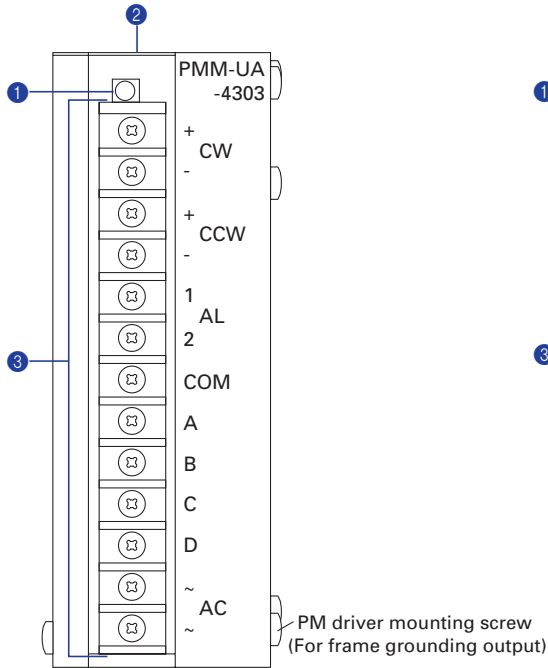

PMM-UA-4304-1

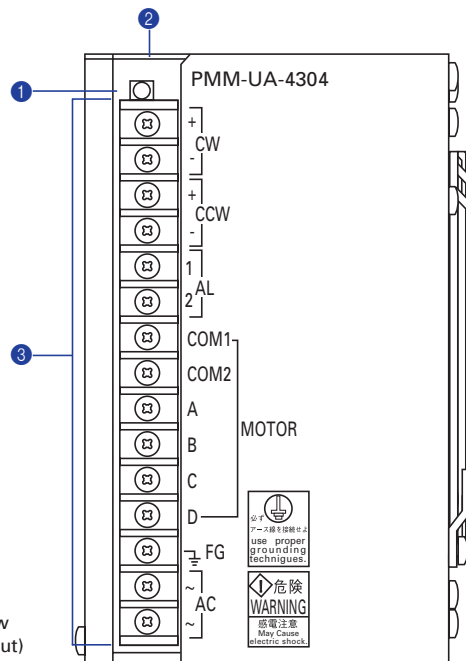

1 Monitor indication (AL) --- PMM-UA-4303-1 and PMM-BA-4304-1 in common

Indication	Color	State
AL	Red	When the element temperature becomes 80°C MIN, in the PM driver, heat protective alarm circuit for the internal elements is activated and this LED illuminates. As the alarm circuit is activated, the operating current is shut and the stepping motor becomes in a de-excited state. Simultaneously, the alarm output relay is closed to generate the output signal. When the element temperature falls back to 80°C MAX, the alarm is automatically released and the current flows into the stepping motor. When the alarm is ON, turn the main power OFF before the automatic recovery system works, and take measures to reduce heat generation such as forced cooling to the PM driver enclosure

2 Function selection DIP switch pack (OH, IS3, IS2, IS1, SL, EX)

PMM-UA-4303-1

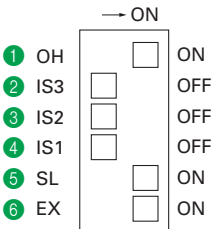

- The factory setting is shown in the figure above.
- Turn off the power supply to the PM driver before changing DIP switch setting.

1 OH (OH selection)

This switch is not used. Do not set it to OFF.

5 SL (Auto current down selection)

Select for the automatic current reduction.

SL	Auto current down
ON	Approx 50% of current rating when stopped
OFF	100% of current rating when stopped

- The temperature increase in the motor driver can be controlled by setting SL to On (approx. 50% of the rated current).
- The output torque when SL is On (approx. 50% of the rated current) is approx. 50% of the that when SL is Off (100% of the rated current).

2 3 4 IS1, IS2, IS3 (Operating current selection)

*When excited for single phase:

IS3	IS2	IS1	Wire-wound current (*)
OFF	OFF	OFF	2A/phase
ON	OFF	OFF	1.8A/phase
OFF	ON	OFF	1.5A/phase
OFF	OFF	ON	1.2A/phase
ON	OFF	ON	1.0A/phase

- The operating current reduces to 80% for the 2-phase exciting.

6 EX (Exciting mode selection)
Select exciting mode.

EX	Exciting mode
ON	Half step (0.9°/pulse)
OFF	Full step (1.8°/pulse)

PMM-BA-4803
PMM-BA-4804

PMM-UA-4303
PMM-UA-4304

PMM-UD-2316-10/2321-10
PMM-UD-2320-21/2321-21
PMM-UD-2320-10/2321-10

PMM-UD-23120

Operation, Connection, and Function

PMM-UA-4304-1

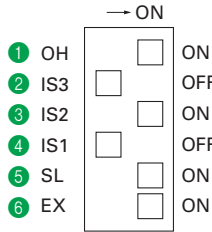

- The factory setting is shown in the figure above.
- Turn off the power supply to the PM driver before changing DIP switch setting.

1 OH (OH selection)

This switch is not used. Do not set it to OFF.

5 SL (Auto current down selection)

Select for the automatic current reduction.

SL	Auto current down
ON	Approx 50% of current rating when stopped
OFF	100% of current rating when stopped

- The temperature increase in the motor driver can be controlled by setting SL to On (approx. 50% of the rated current).
- The output torque when SL is On (approx. 50% of the rated current) is approx. 50% of the that when SL is Off (100% of the rated current).

2 3 4 IS1, IS2, IS3 (Operating current selection)

*When excited for single phase:

IS3	IS2	IS1	Wire-wound current (*)
OFF	OFF	OFF	5A/phase
ON	OFF	OFF	4.6A/phase
OFF	ON	OFF	4A/phase
OFF	OFF	ON	3.6A/phase

- The operating current reduces to 80% for the 2-phase exciting.

6 EX (Exciting mode selection)

Select exciting mode.

EX	Exciting mode
ON	Half step (0.9°/pulse)
OFF	Full step (1.8°/pulse)

3 Terminal block (TB) --- PMM-UA-4303-1 and PMM-BA-4304-1 in common

Connects I/O signals, single phase AC power supply, and the stepping motor power cord.

External wiring diagram

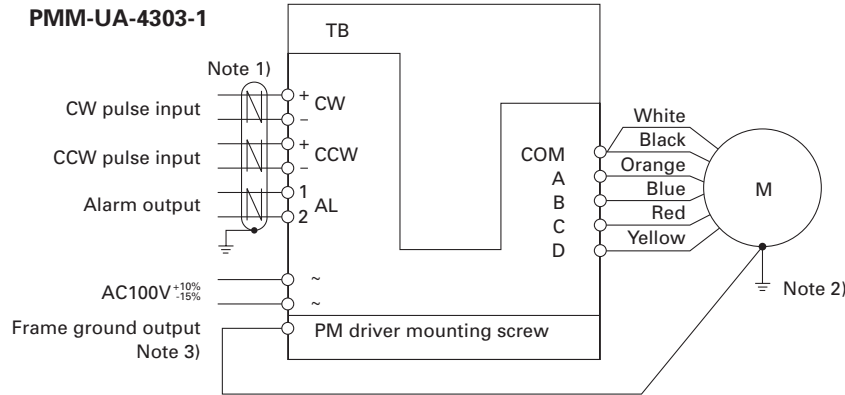

Note 1) Use twist pair shielded cables.

Note 2) Ground the flange of the stepping motor by fastening the grounding wire together with its mounting screw. The grounding shall be made at a single point.

Note 3) Make grounding by the stepping motor mounting screw share for mounting the PM driver. The grounding shall be made at a single point.

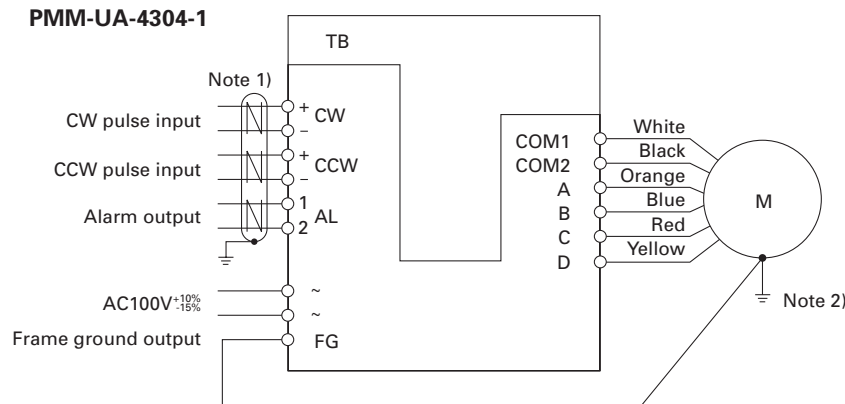

Note 1) Use twist pair shielded cables.

Note 2) Ground the flange of the stepping motor by fastening the grounding wire together with its mounting screw. The grounding shall be made at a single point.

Dimensions [Unit:mm(inch)]

PMM-UA-4303-1

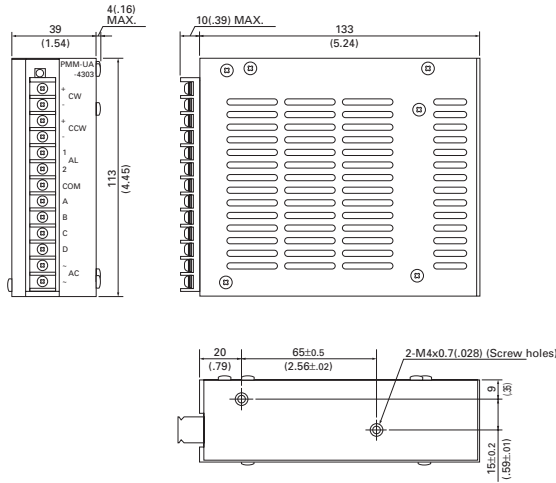

PMM-UA-4304-1

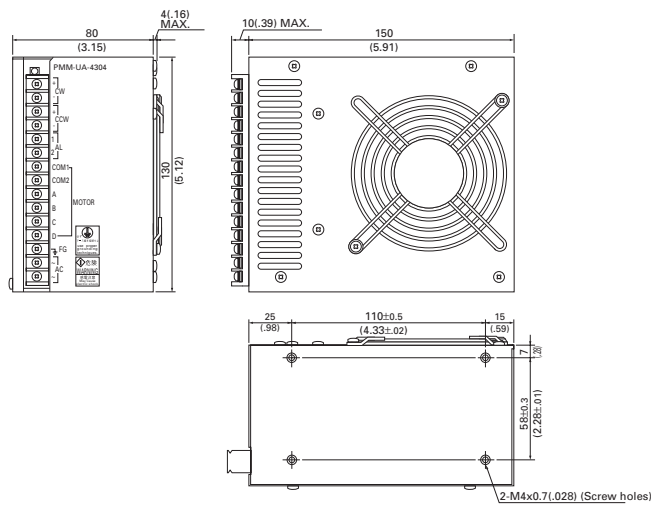

Mounting direction and mounting position [Unit:mm(inch)]

PMM-UA-4303-1

PMM-UA-4304-1

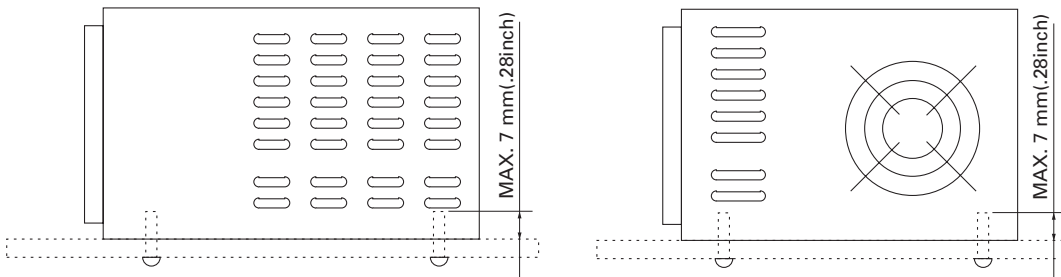

- Mount the PM driver as it stands upright.
- Use the mounting holes in the bottom of the PM driver with M4 screws as shown in the figure. (No mounting hardware is required.)
- The length of the screws projecting inward the driver enclosure shall be shorter than 7mm(0.28inch).

PMM-BA-4803
PMM-BA-4804

PMM-UA-4303
PMM-UA-4304

PMM-UD-2310-10/2321-10
PMM-UD-2320-21/2321-21
PMM-UD-2320-10/2321-10

PMM-UD-23120

Pulse Rate-Torque Characteristics/Pulse Rate-Power Current Characteristics

PMM-UA-4303-1

fs: No load maximum starting pulse rate. ■ Full-step ■ Half-step

● 103H5205-04 □ □ : 100V

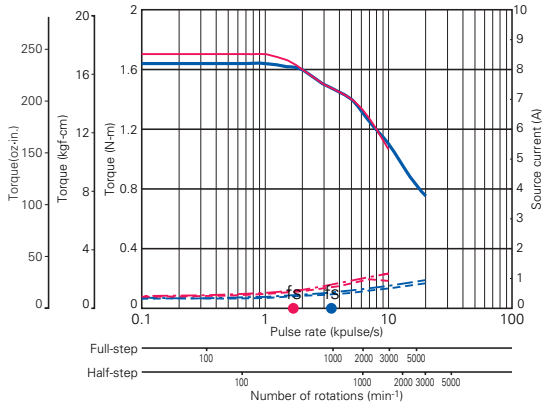

Source voltage: AC100V, Operating current : 1.2A/phase
 — Pull-Out torque [$JL_1=0.94 \times 10^{-4} \text{kg} \cdot \text{m}^2$ (5.14 oz-in²) Use the rubber coupling]
 - - - Source current (TL=MAX), - - - Source current (TL=0)

● 103H5208-04 □ □ : 100V

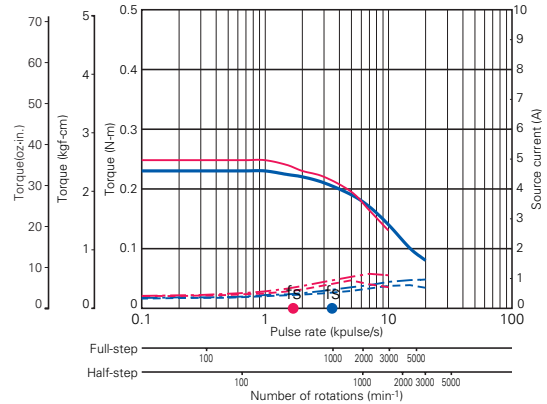

Source voltage: AC100V, Operating current : 1.2A/phase
 — Pull-Out torque [$JL_1=0.94 \times 10^{-4} \text{kg} \cdot \text{m}^2$ (5.14 oz-in²) Use the rubber coupling]
 - - - Source current (TL=MAX), - - - Source current (TL=0)

● 103H5209-04 □ □ : 100V

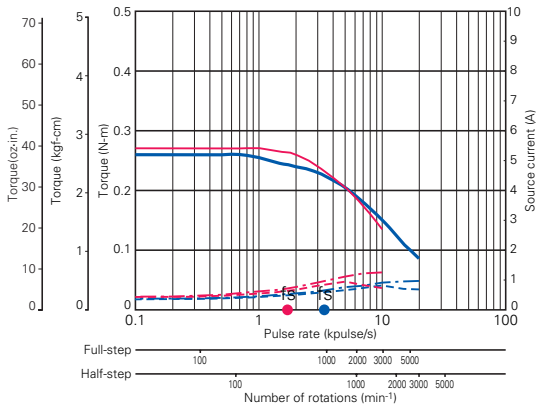

Source voltage: AC100V, Operating current : 1.2A/phase
 — Pull-Out torque [$JL_1=0.94 \times 10^{-4} \text{kg} \cdot \text{m}^2$ (5.14 oz-in²) Use the rubber coupling]
 - - - Source current (TL=MAX), - - - Source current (TL=0)

● 103H5210-04 □ □ : 100V

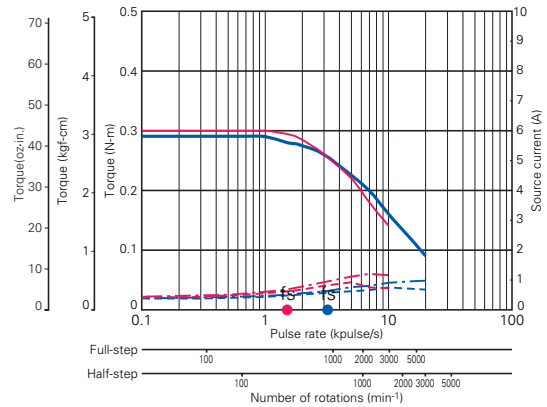

Source voltage: AC100V, Operating current : 1.2A/phase
 — Pull-Out torque [$JL_1=0.94 \times 10^{-4} \text{kg} \cdot \text{m}^2$ (5.14 oz-in²) Use the rubber coupling]
 - - - Source current (TL=MAX), - - - Source current (TL=0)

● 103H6701-04 □ □ : 100V

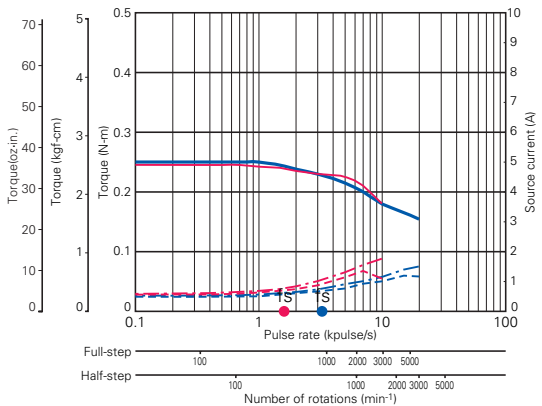

Source voltage: AC100V, Operating current : 2A/phase
 — Pull-Out torque [$JL_1=0.94 \times 10^{-4} \text{kg} \cdot \text{m}^2$ (5.14 oz-in²) Use the rubber coupling]
 - - - Source current (TL=MAX), - - - Source current (TL=0)

● 103H6703-04 □ □ : 100V

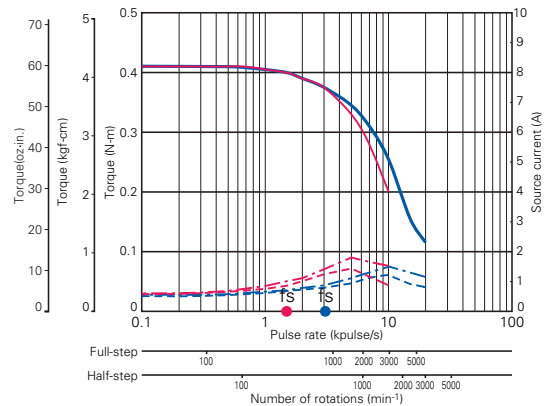

Source voltage: AC100V, Operating current : 2A/phase
 — Pull-Out torque [$JL_1=0.94 \times 10^{-4} \text{kg} \cdot \text{m}^2$ (5.14 oz-in²) Use the rubber coupling]
 - - - Source current (TL=MAX), - - - Source current (TL=0)

Pulse Rate-Torque Characteristics/Pulse Rate-Power Current Characteristics

PMM-UA-4303-1

● 103H6704-04 □□ : 100V

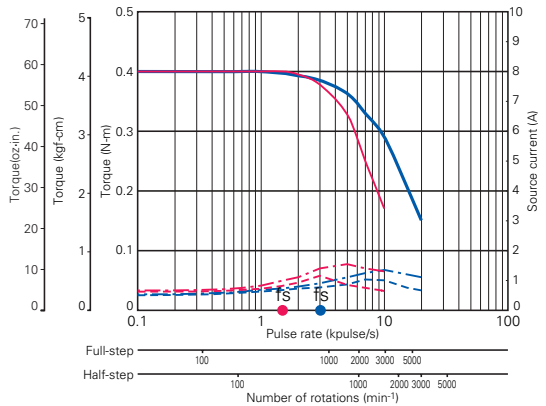

Source voltage: AC100V, Operating current : 2A/phase
 — Pull-Out torque (JL1=0.94x10⁻⁴kg-m²(5.14 oz-in²) Use the rubber coupling)
 - - - Source current (TL=MAX), - - - Source current (TL=0)

● 103H7121-04 □□ : 100V

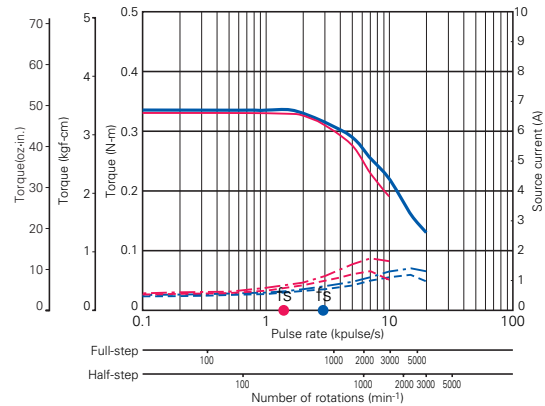

Source voltage: AC100V, Operating current : 2A/phase
 — Pull-Out torque (JL1=0.94x10⁻⁴kg-m²(5.14 oz-in²) Use the rubber coupling)
 - - - Source current (TL=MAX), - - - Source current (TL=0)

● 103H7123-04 □□ : 100V

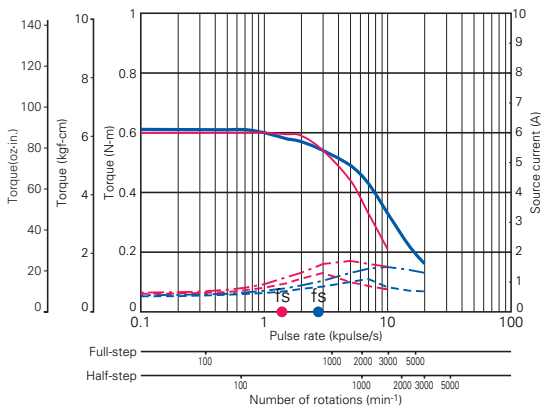

Source voltage: AC100V, Operating current : 2A/phase
 — Pull-Out torque (JL1=0.94x10⁻⁴kg-m² (5.14 oz-in²) Use the rubber coupling)
 - - - Source current (TL=MAX), - - - Source current (TL=0)

● 103H7124-04 □□ : 100V

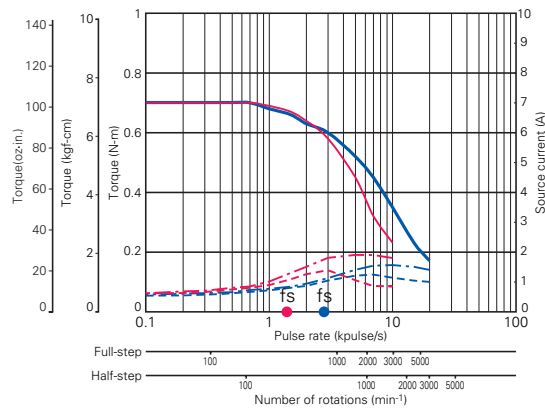

Source voltage: AC100V, Operating current : 2A/phase
 — Pull-Out torque (JL1=0.94x10⁻⁴kg-m² (5.14 oz-in²) Use the rubber coupling)
 - - - Source current (TL=MAX), - - - Source current (TL=0)

● 103H7126-04 □□ : 100V

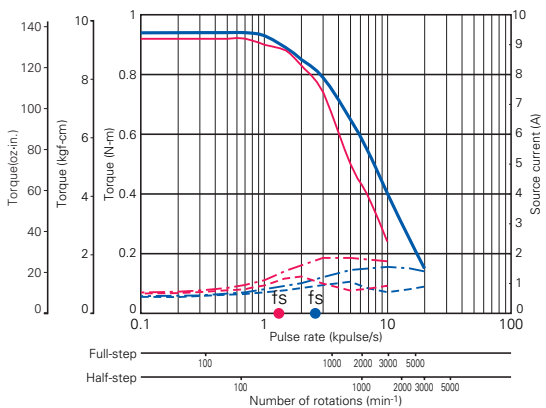

Source voltage: AC100V, Operating current : 2A/phase
 — Pull-Out torque (JL1=2.6x10⁻⁴kg-m² (14.22 oz-in²) Use the rubber coupling)
 - - - Source current (TL=MAX), - - - Source current (TL=0)

● 103H7821-04 □□ : 100V

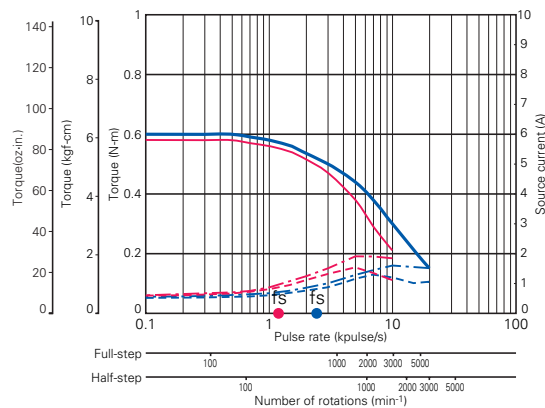

Source voltage: AC100V, Operating current : 2A/phase
 — Pull-Out torque (JL1=0.94x10⁻⁴kg-m² (5.14 oz-in²) Use the rubber coupling)
 - - - Source current (TL=MAX), - - - Source current (TL=0)

PMM-BA-4803
PMM-BA-4804

PMM-UA-4303
PMM-UA-4304

PMM-UD-2310-10/2321-10
PMM-UD-2320-21/2321-21
PMM-UD-2320-10/2321-10

PMM-UD-23120

Pulse Rate-Torque Characteristics/Pulse Rate-Power Current Characteristics

fs: No load maximum starting pulse rate. ■ Full-step ■ Half-step

PMM-UA-4303-1

● 103H7822-04 □ □ : 100V

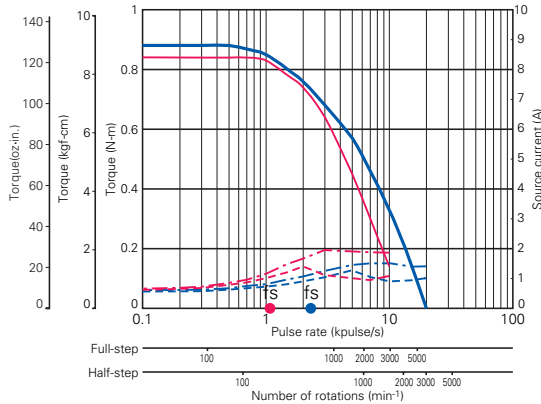

Source voltage: AC100V, Operating current : 2A/phase
 — Pull-Out torque [$JL_1=2.6 \times 10^{-4} \text{kg}\cdot\text{m}^2$ (14.22 oz-in²) Use the rubber coupling]
 - - - Source current (TL=MAX), - - - Source current (TL=0)

● 103H7823-04 □ □ : 100V

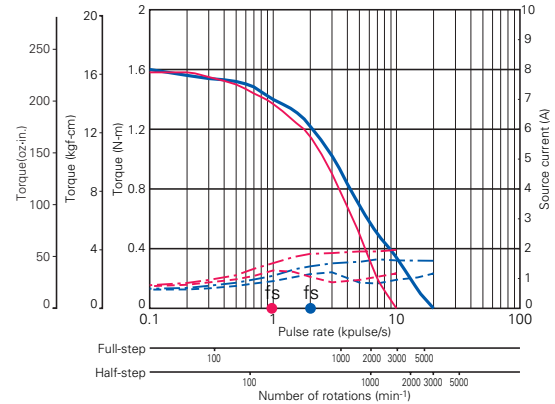

Source voltage: AC100V, Operating current : 2A/phase
 — Pull-Out torque [$JL_1=2.6 \times 10^{-4} \text{kg}\cdot\text{m}^2$ (14.22 oz-in²) Use the rubber coupling]
 - - - Source current (TL=MAX), - - - Source current (TL=0)

● 103H8221-04 □ □ : 100V

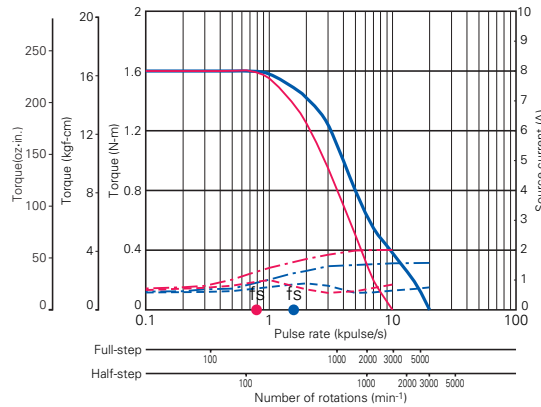

Source voltage: AC100V, Operating current : 2A/phase
 — Pull-Out torque [$JL_1=15.3 \times 10^{-4} \text{kg}\cdot\text{m}^2$ (83.65 oz-in²) Use the rubber coupling]
 - - - Source current (TL=MAX), - - - Source current (TL=0)

● 103H8222-04 □ □ : 100V

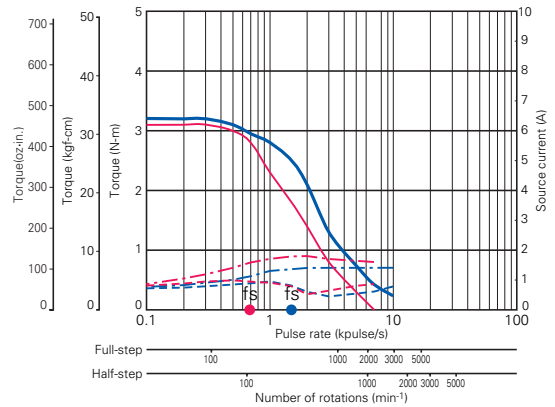

Source voltage: AC100V, Operating current : 2A/phase
 — Pull-Out torque [$JL_1=15.3 \times 10^{-4} \text{kg}\cdot\text{m}^2$ (83.65 oz-in²) Use the rubber coupling]
 - - - Source current (TL=MAX), - - - Source current (TL=0)

PMM-UA-4304-1

● 103H8223-04 □ □ : 100V

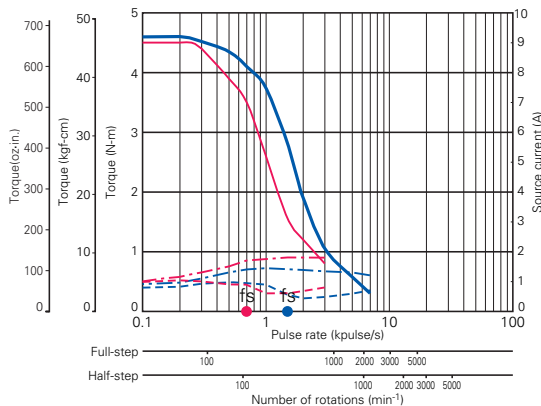

Source voltage: AC100V, Operating current : 2A/phase
 — Pull-Out torque [$JL_1=15.3 \times 10^{-4} \text{kg}\cdot\text{m}^2$ (83.65 oz-in²) Use the rubber coupling]
 - - - Source current (TL=MAX), - - - Source current (TL=0)

● 103H8221-09 □ □ : 100V

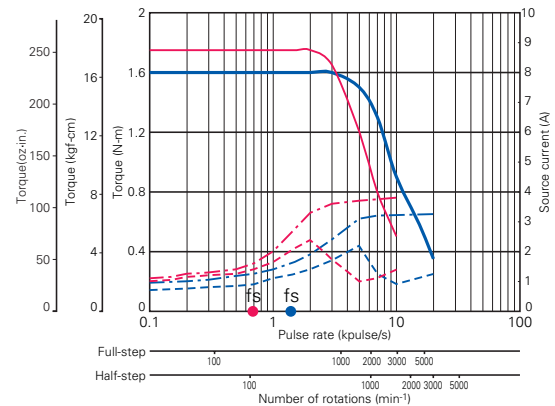

Source voltage: AC100V, Operating current : 4A/phase
 — Pull-Out torque [$JL_1=15.3 \times 10^{-4} \text{kg}\cdot\text{m}^2$ (83.65 oz-in²) Use the rubber coupling]
 - - - Source current (TL=MAX), - - - Source current (TL=0)

Pulse Rate-Torque Characteristics/Pulse Rate-Power Current Characteristics

PMM-UA-4304-1

● 103H8222-09 □□ : 100V

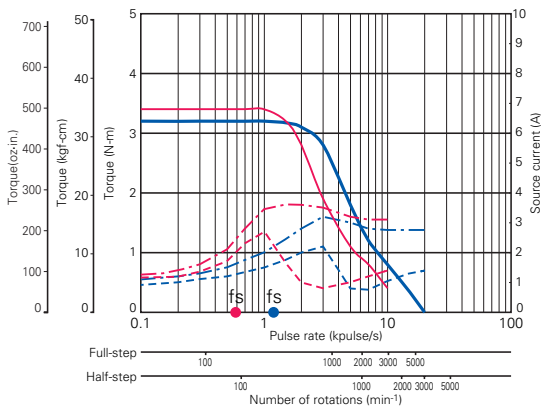

Source voltage : AC100V, Operating current : 4A/phase
 — Pull-Out torque [$JL_1=15.3 \times 10^{-4} \text{kg}\cdot\text{m}^2$ (83.65 oz-in²) Use the rubber coupling]
 - - - Source current (TL=MAX), - - - Source current (TL=0)

● 103H8223-09 □□ : 100V

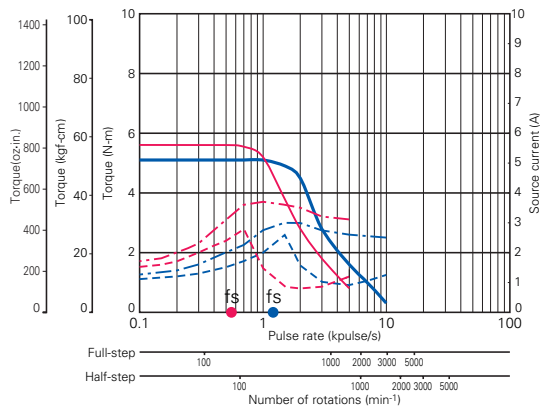

Source voltage : AC100V, Operating current : 4A/phase
 — Pull-Out torque [$JL_1=15.3 \times 10^{-4} \text{kg}\cdot\text{m}^2$ (83.65 oz-in²) Use the rubber coupling]
 - - - Source current (TL=MAX), - - - Source current (TL=0)

● 103H89222-09 □□ : 100V

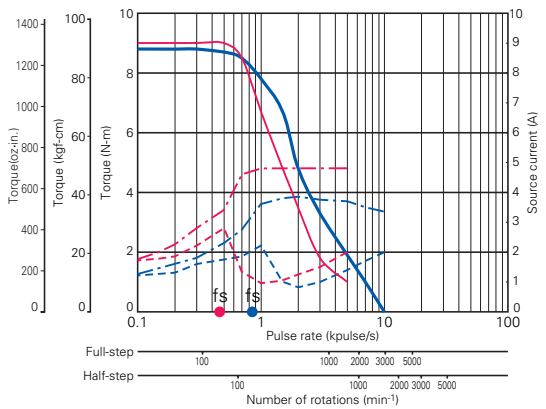

Source voltage : AC100V, Operating current : 4A/phase
 — Pull-Out torque [$JL_1=43 \times 10^{-4} \text{kg}\cdot\text{m}^2$ (235.10 oz-in²) Use the rubber coupling]
 - - - Source current (TL=MAX), - - - Source current (TL=0)

● 103H89223-09 □□ : 100V

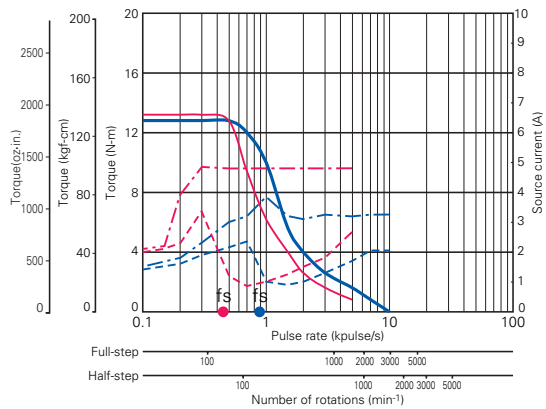

Source voltage : AC100V, Operating current : 4A/phase
 — Pull-Out torque [$JL_1=43 \times 10^{-4} \text{kg}\cdot\text{m}^2$ (235.10 oz-in²) Use the rubber coupling]
 - - - Source current (TL=MAX), - - - Source current (TL=0)

Options

● Terminal board cover

PMM-UA-4303-1

Model No.	PM-AP-018
-----------	-----------

PMM-UA-4304-1

Model No.	PM-AP-019
-----------	-----------

2-phase Stepping Driver



DC24V/36V Unipolar type

(Applicable motor rated current 1.2A/phase, 2A/phase)

Micro-step (200 X 1~8 divisions)

(Smooth operation and low vibration even at low speeds.)

PMM-MD-23210-10 (Photo coupler input method)

PMM-MD-23211-10 (CMOS input method)

PMM-MD-23220-21 (Photo coupler input method)

PMM-MD-23221-21 (CMOS input method)

PMM-MD-23220-10 (Photo coupler input method)

PMM-MD-23221-10 (CMOS input method)

● Applicable motor



● Applicable motor



● Applicable motor



Standard combined stepping motors

PMM-MD-23210-10, PMM-MD-23211-10

Dimensions of stepping motor	Stepping motor model number		Rated current [A/phase]	Holding torque [N·m(oz-in)]	Rotor inertia [x 10 ⁻⁴ kg·m ² (oz-in ²)]	Mass(Weight) [kg(lbs)]	Page
	Single shaft	Double shaft					
□28mm(1.10inch)	103H3215-5240	103H3215-5210	1	0.062(8.78)	0.016(0.09)	0.22(0.49)	65 Page

PMM-MD-23220-21, PMM-MD-23221-21

Dimensions of stepping motor	Stepping motor model number		Rated current [A/phase]	Holding torque [N·m(oz-in)]	Rotor inertia [x 10 ⁻⁴ kg·m ² (oz-in ²)]	Mass(Weight) [kg(lbs)]	Page
	Single shaft	Double shaft					
□35mm	SH3533-12U40	SH3533-12U10	1.2	0.12(16.99)	0.02(1.09)	0.17(0.37)	61 Page
	SH3537-12U40	SH3537-12U10	1.2	0.15(21.24)	0.025(1.37)	0.2(0.44)	
	SH3552-12U40	SH3552-12U10	1.2	0.24(33.99)	0.043(2.35)	0.3(0.66)	
□42mm (1.65inch)	103H5205-0440	103H5205-0410	1.2	0.2(28.32)	0.036(0.20)	0.23(0.51)	64 Page
	103H5208-0440	103H5208-0410	1.2	0.3(42.48)	0.056(0.31)	0.29(0.64)	
	103H5209-0440	103H5209-0410	1.2	0.32(45.31)	0.062(0.34)	0.31(0.68)	
	103H5210-0440	103H5210-0410	1.2	0.37(52.39)	0.074(0.40)	0.37(0.82)	

PMM-MD-23220-10, PMM-MD-23221-10

Dimensions of stepping motor	Stepping motor model number		Rated current [A/phase]	Holding torque [N·m(oz-in)]	Rotor inertia [x 10 ⁻⁴ kg·m ² (oz-in ²)]	Mass(Weight) [kg(lbs)]	Page
	Single shaft	Double shaft					
□50mm (1.97inch)	103H6701-0440	103H6701-0410	2	0.28(39.6)	0.057(0.31)	0.35(0.77)	75 Page
	103H6703-0440	103H6703-0410	2	0.49(69.4)	0.118(0.65)	0.5(1.10)	
	103H6704-0440	103H6704-0410	2	0.52(73.6)	0.14(0.77)	0.5(1.10)	
□56mm (2.20inch)	103H7121-0440	103H7121-0410	2	0.39(55.2)	0.1(0.55)	0.47(1.04)	79 Page
	103H7123-0440	103H7123-0410	2	0.83(117.5)	0.21(1.15)	0.65(1.43)	
	103H7124-0440	103H7124-0410	2	0.98(138.8)	0.245(1.34)	0.8(1.76)	
	103H7126-0440	103H7126-0410	2	1.27(179.8)	0.36(1.97)	0.98(2.16)	
□60mm (2.36inch)	103H7821-0440	103H7821-0410	2	0.78(110.5)	0.275(1.50)	0.6(1.32)	87 Page
	103H7822-0440	103H7822-0410	2	1.17(165.7)	0.4(2.19)	0.77(1.70)	
	103H7823-0440	103H7823-0410	2	2.1(297.4)	0.84(4.59)	1.34(2.95)	
ø86mm (3.39inch)	103H8221-0441	103H8221-0411	2	2.15(304.5)	1.45(7.93)	1.5(3.31)	91 Page
	103H8222-0441	103H8222-0411	2	4.13(584.8)	2.9(15.86)	2.5(5.51)	
	103H8223-0441	103H8223-0411	2	6.27(887.9)	4.4(24.06)	3.5(7.72)	

• For information about the general specifications and dimensions of each stepping motor, refer to its page.

Specifications of PM Driver

Item		Photo coupler input method			CMOS input method			
		PMM-MD-23210-10	PMM-MD-23220-21	PMM-MD-23220-10	PMM-MD-23211-10	PMM-MD-23221-21	PMM-MD-23221-10	
Basic specifications	Input source	Main power	DC24V/36V±10%					
		Control power	—			DC5V±5%		
	Getaway torque	Main power	2A	2A	3A	2A	2A	3A
		Control power	—					
	Rated current	1A/phase	1.2A/phase	2A/phase	1A/phase	1.2A/phase	2A/phase	
	Operating ambient temperature	0~+50°C						
	Conservation temperature	-20~+70°C						
	Operating ambient humidity	35~85% RH (no condensation)						
	Conservation humidity	10~90% RH (no condensation)						
	Vibration resistance	4.9m/s ² Frequency range 10~55Hz, Direction: along X,Y and Z axes, for 2 hours each.						
Impact resistance	Considering the NDS-C-0110 standard section 3.2.2 division "C", not influenced.							
Withstand voltage	Not influenced when AC500V is applied between power input terminal and cabinet for one minute.							
Insulation resistance	10MΩ MIN. when measured with DC500V megohmmeter between input terminal and cabinet.							
Mass(Weight)	0.18kg(0.4lbs)							
Function	Pulse input mode selection— DIP switches enables selection of Pulse and direction and 2-input mode. Resolution setting— DIP switches enables 4 divisions ranging from 1~8 resolution. Power down — External signal input enables to turn off the current that flows through the stepping motor. Automatic current down selection— Automatic current down function can be selected. Resolution selection— External signal input enables to select 1 division (Full-step) and 2 divisions (Half-step) (Resolution selection function is only for photo coupler input method type)							
I/O signals	Signal Name (Brevity code)	Pin No. (CN1)						
		Photo coupler input method	CMOS input method					
	CW pulse Input signal (CW)	1 2	7	In the 2-input mode, inputs driving pulses to rotate in CW direction.				
	(CK)			In the Pulse and direction mode, inputs driving pulse train to rotate the step motor rotation. Photo coupler input method, input resistance 330Ω CMOS input method Input signal voltage: H = 4.0 to 5.5V, L = 0 to 0.5V Input signal voltage: H = 4.0 to 5.5V, L = 0 to 0.5V Maximum input frequency:20kpulse/s Maximum input frequency:20kpulse/s.				
	CCW pulse Input signal (CCW)	3 4	8	In the 2-input mode, inputs driving pulses to rotate in CCW direction.				
	(U/D)			In the Pulse and direction mode, inputs rotation direction signals to the stepping motor. Internal photo coupler ON (CMOS type: "H" level): — CW direction Internal photo coupler OFF (CMOS type: "L" level)— CCW direction. Photo coupler input method, input resistance 330Ω CMOS input method Input signal voltage: H = 4.0 to 5.5V, L = 0 to 0.5V Input signal voltage: H = 4.0 to 5.5V, L = 0 to 0.5V Maximum input frequency:20kpulse/s Maximum input frequency:20kpulse/s.				
	Power down input signal (PD)	5 6	9	Inputs PD signal to turn off the current that flows through the stepping motor. Internal photo coupler ON (CMOS type: "L" level input) — Power down function is enabled. Photo coupler input method, input resistance 330Ω CMOS input method Input signal voltage: H = 4.0 to 5.5V, L = 0 to 0.5V Input signal voltage: H = 4.0 to 5.5V, L = 0 to 0.5V				
	Step angle selection input (S. SEL)	—	10	By the input S or SEL signal, the step angle of full-step or half-step is selected. "H" level: — Half-step "L" level — Full-step CMOS input method Input signal voltage: H = 4.0 to 5.5V, L = 0 to 0.5V				
Phase origin monitor output signal (MON)	7 8	11	Indicates ON when the exciting phase is at the origin position. In the full-step, outputs once for every 4 pulses. In the half-step, outputs once for every 8 pulse From the photo coupler by the open collector output (ON at the phase origin). From the transistor by the open collector output (ON at the phase origin). Output specification: Vceo=30V MAX. Ic=5mA MAX. Output specification: Vceo=30V MAX. Ic=5mA MAX.					

- Stepping motor rotation in the CW direction means clockwise rotation when facing the output shaft (the flange side) of the stepping motor. CCW direction means counterclockwise rotation when facing the same side.
- Set the DIP switch as follows when using the step angle selection function by signal input.

EX1	EX2	EX3
OFF	ON	ON

- When the half-step is selected by the step angle selection signal, its torque ought to be 70% of that for the full-step.

Operation, Connection, and Function

PMM-MD-23210-10(Photo coupler input method) PMM-MD-23220-21(Photo coupler input method) PMM-MD-23220-10(Photo coupler input method)

● Input circuit configuration (CW, CCW)

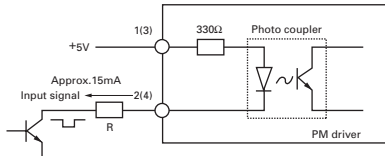

- Pulse duty 50% MAX.
- When the crest value of the input signal is 5V, the external limit resistance R must be 0Ω.
When the crest value of the input signal exceeds 5V, use the external limit resistance R to limit the input current to approximately 15mA.

Input signal specifications

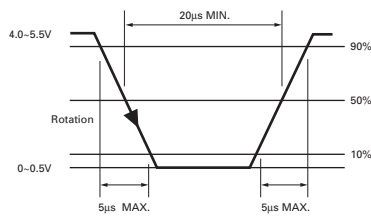

Timing of command pulse

- 2-input mode (CW, CCW)

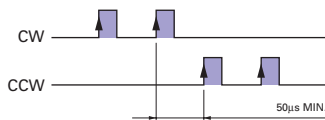

- The internal photo coupler turns ON within the and, at its rising edge to ON, the internal circuit (stepping motor) is activated.
- When applying the pulse to CW, turn OFF the CCW side internal photo coupler.
- When applying the pulse to CCW, turn OFF the CW side internal photo coupler.

- Pulse and direction mode (CK,U/D)

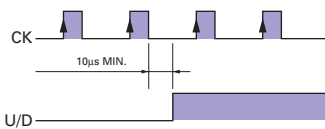

- The internal photo coupler turns ON within the and, at the rising edge to ON of the CK photo coupler, the internal circuit (stepping motor) is activated.
- Switching the input signal U/D shall be performed while the internal photo coupler on the CK side is OFF.

PMM-MD-23211-10(CMOS input method) PMM-MD-23221-21(CMOS input method) PMM-MD-23221-10(CMOS input method)

● Input circuit configuration (CW, CCW)

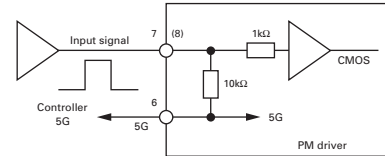

- Pulse duty 50% MAX.

Input signal specifications

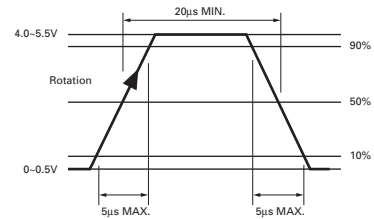

Timing of command pulse

- 2-input mode (CW, CCW)



- The "H" level is input at and, at its rising edge to "H" level, the internal circuit (stepping motor) is activated.
- When applying the pulse to CW, turn OFF the CCW side internal photo coupler.
- When applying the pulse to CCW, turn OFF the CW side internal photo coupler.

- Pulse and direction mode (CK,U/D)

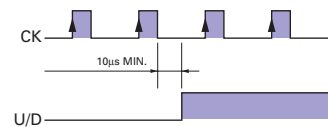

- The "H" level is input for and, at its rising edge to "H" level, the internal circuit (stepping motor) is activated.
- Switching the input signal U/D should be performed while the input level on the CK side is "L".

Operation, Connection, and Function

PMM-MD-23210-10(Photo coupler input method)
PMM-MD-23220-21(Photo coupler input method)
PMM-MD-23220-10(Photo coupler input method)

● Input circuit configuration (PD)

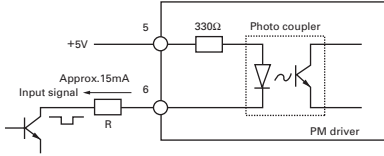

- When the crest value of the input signal is 5V, the external limit resistance R must be 0Ω. When the crest value of the input signal exceeds 5V, use the external limit resistance R to limit the input current to approximately 15mA.

● Output circuit configuration (MON)

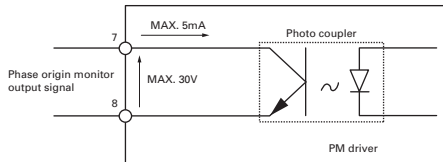

- Phase origin monitor output signal
 Contact mode: Open collector output of the photo coupler
 Contact capacity: DC30V 5mA MAX.

Timing of MON output (in 1-division setting)

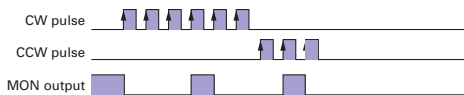

- The internal photo coupler or transistor turns ON at ■.

PMM-MD-23211-10(CMOS input method)
PMM-MD-23221-21(CMOS input method)
PMM-MD-23221-10(CMOS input method)

● Input circuit configuration (PD, S, SEL)

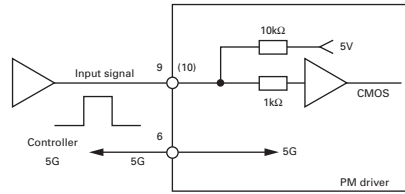

- Phase origin monitor output signal
 Contact mode: Open collector output by the transistor
 Contact capacity: DC30V 5mA MAX.

● Output circuit configuration (MON)

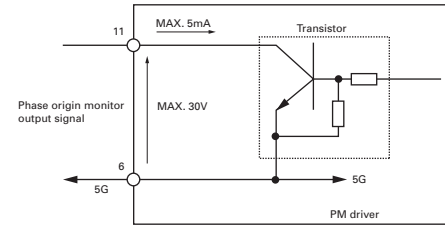

- Phase origin monitor output signal
 Contact mode: Open collector output by the transistor
 Contact capacity: DC30V 5mA MAX.

Timing of MON output (in 1-division setting)

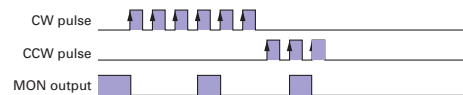

- The internal photo coupler or transistor turns ON at ■.

PMM-BA-4803
 PMM-BA-4804
 PMM-UA-4303
 PMM-UA-4304
 PMM-MD-23210-10/23211-10
 PMM-MD-23220-21/23221-21
 PMM-MD-23220-10/23221-10
 PMM-MD-23120

Operation, Connection, and Function

● PM driver component names

PMM-MD-23210-10(Photo coupler input method)
PMM-MD-23220-21(Photo coupler input method)
PMM-MD-23220-10(Photo coupler input method)

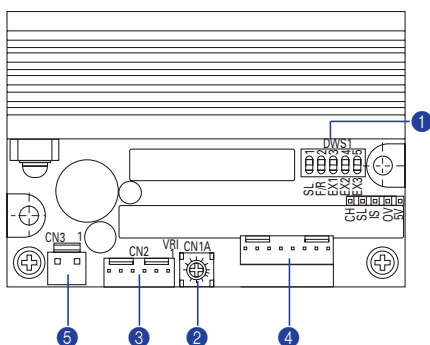

PMM-MD-23211-10(CMOS input method)
PMM-MD-23221-21(CMOS input method)
PMM-MD-23221-10(CMOS input method)

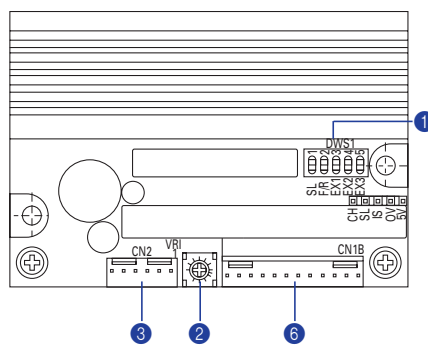

① Function selection DIP switch pack --- All models in common

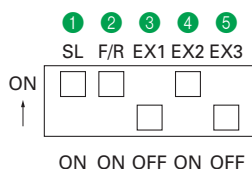

- The factory setting is shown in the figure above.
- Turn off the power supply to the PM driver before changing DIP switch setting.

① SL (Auto current down selection)
 Select Auto current down function selection.

SL	Auto current down
ON	Approx 50% of current rating when stopped
OFF	100% of current rating when stopped

- The temperature increase in the motor driver can be controlled by setting SL to On(approx.50% of the rated current).
- The output torque when SL is On(approx. 50% of the rated current) is approx.50% of the that when SL is Off (100% of the rated current).

② F/R (Pulse-input method selection)
 Select the pulse-input method.

F/R	Pulse-input mode
ON	2-input mode (CW, CCW)
OFF	Pulse and direction mode (CK, U/D)

③ ④ ⑤ EX1, EX2, EX3 (Step angle setting selection)
 Enables selection of division numbers of basic step angles when micro step is driven.

EX1	EX2	EX3	Number of divisions
ON	ON	ON	1 (Full step)
OFF	ON	OFF	2 (Half step)
ON	OFF	OFF	4
OFF	OFF	OFF	8

② Operating-current adjustment controller (VR1) --- All models in common

The controller is to adjust operating-current of the stepping motor.

The factory setting is at the rated current of standard combined stepping motor.

③ Connector (CN2) --- All models in common

Connects motor power line

④ Connector (CN1A) --- Photo coupler input method

Connects I/O line

⑤ Connector (CN3) --- Photo coupler input method

Connects DC power line

⑥ Connector (CN1B) --- CMOS input method

Connect I/O line and DC power line

Operation, Connection, and Function

● External wiring diagram

PMM-MD-23210-10(Photo coupler input method)
PMM-MD-23220-21(Photo coupler input method)
PMM-MD-23220-10(Photo coupler input method)

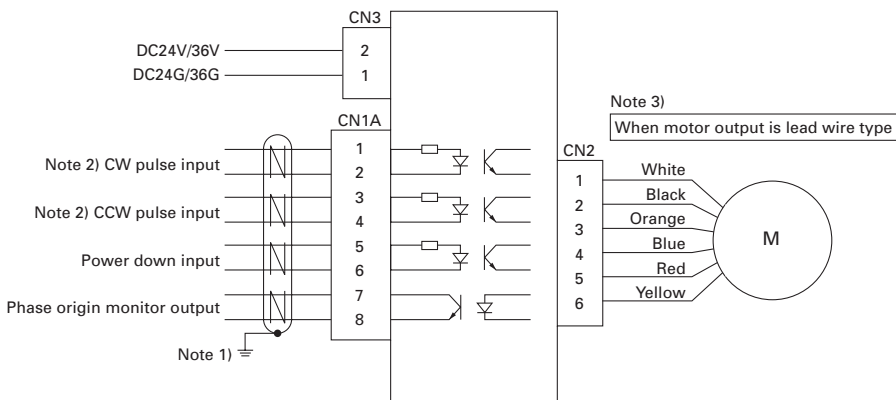

Note 3)
When motor output is connector type

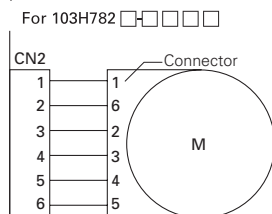
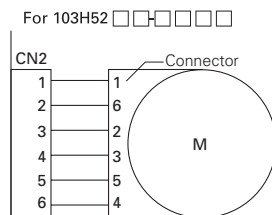
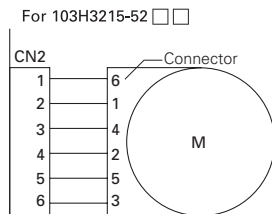

● Connectors used

PM Diver side		Corresponding connector model number	Maker
Use	Model number		
For I/O signal (CN1A)	5045-08AG	Corresponding housing: 5051-08 Corresponding contact: 2759PBG	Molex
For stepping motor (CN2)	5045-06A	Corresponding housing: 5051-06 Corresponding contact: 5159PBT	Molex
For DC power source (CN3)	5273-02A	Corresponding housing: 5195-02 Corresponding contact: 5194PBT	Molex

• For the applicable connector, the client is requested to procure or place orders with us from the optional connector sets or the connector cables we offer. (Refer to the page 41.)

PMM-MD-23211-10(CMOS input method)
PMM-MD-23221-21(CMOS input method)
PMM-MD-23221-10(CMOS input method)

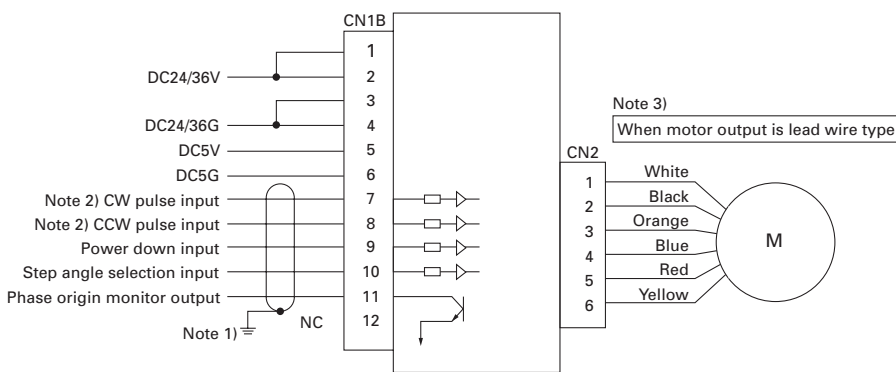

Note 3)
When motor output is connector type

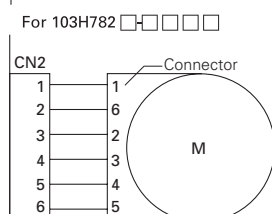
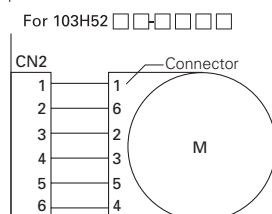
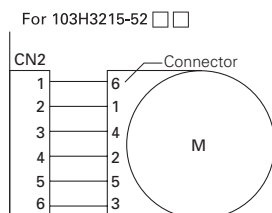

● Connectors used

PM Diver side		Corresponding connector model number	Maker
Use	Model number		
For DC power source and I/O signals (CN1B)	5045-12AG	Corresponding housing: 5051-12 Corresponding contact: 2759PBG	Molex
For stepping motor (CN2)	5045-06A	Corresponding housing: 5051-06 Corresponding contact: 5159PBT	Molex

• For the applicable connector, the client is requested to procure or place orders with us from the optional connector sets or the connector cables we offer. (Refer to the page 41.)

Note 1) Use twist pair shielded cables.

Note 2) Selection is possible between "2-input mode (CW, CCW)" and "Pulse and direction mode (CK, U/D)" by the function selection switch F/R.

Note 3) Motor output of stepping motor models 103H3215, 103H52 □□, 103H782 □ are connector type.

Motor side pin number and driver side connector(CN2) pin number is not match. So please be careful when connecting.

PMM-BA-4803
PMM-BA-4804
PMM-UA-4303
PMM-UA-4304
PMM-MD-23210-10/23211-10
PMM-MD-23220-21/23221-21
PMM-MD-23220-10/23221-10
PMM-MD-23120

Dimensions [Unit:mm(inch)]

PMM-MD-23210(Photo coupler input method)

PMM-MD-23220-21(Photo coupler input method)

PMM-MD-23220-10(Photo coupler input method)

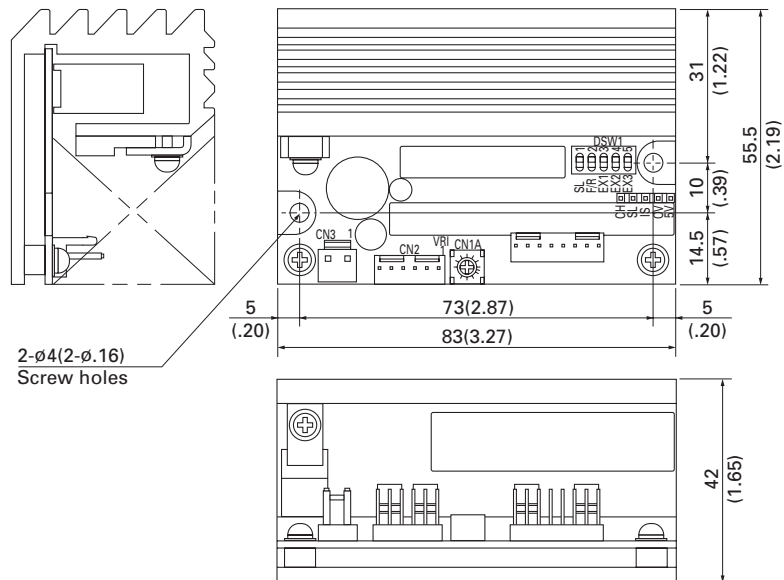

PMM-MD-23211-10(CMOS input method)

PMM-MD-23221-21(CMOS input method)

PMM-MD-23221-10(CMOS input method)

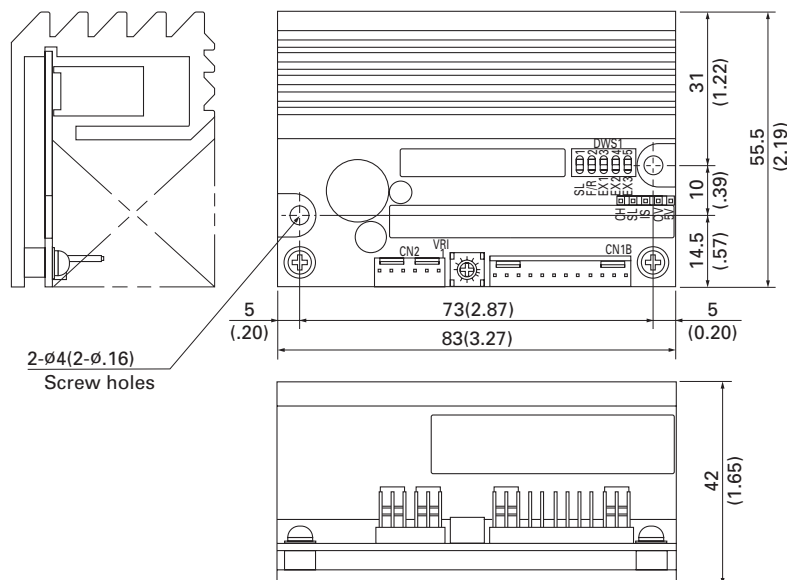

Mounting direction and mounting position

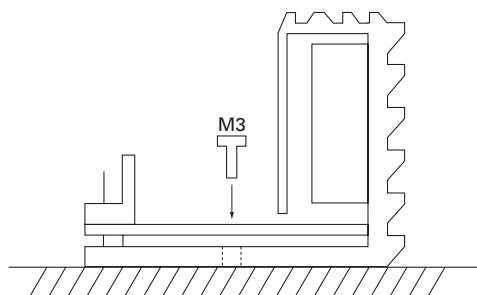

- Install the PM driver vertically.
- As shown in the figure, fix the PM driver by using the M3 screws through two fitting holes (2-φ.4) on the bottom surface of PM driver (no fitting metals are necessary).

Pulse Rate-Torque Characteristics/Pulse Rate-Power Current Characteristics

PMM-MD-23210-10 PMM-MD-23211-10

fs: No load maximum starting pulse rate. ■ 1-division is specified ■ 2-division is specified

● 103H3215-52 □ □ : 24V

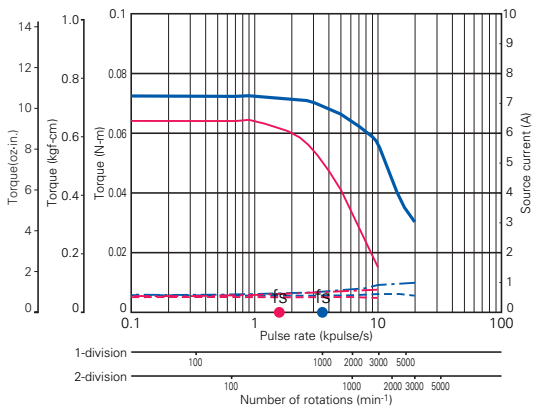

Source voltage: DC24V, Operating current :1A/phase
 — Pull-Out torque [$J_{L1}=0.33 \times 10^{-4} \text{kg}\cdot\text{m}^2$ (1.80 oz-in²) Use the rubber coupling]
 - - - Source current (TL=MAX), - - - Source current (TL=0)

● 103H3215-52 □ □ : 36V

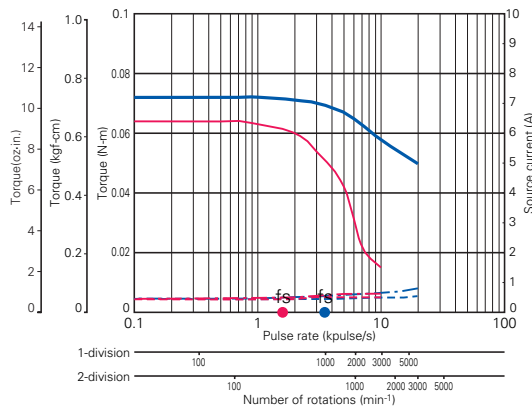

Source voltage: DC36V, Operating current :1A/phase
 — Pull-Out torque [$J_{L1}=0.33 \times 10^{-4} \text{kg}\cdot\text{m}^2$ (1.80 oz-in²) Use the rubber coupling]
 - - - Source current (TL=MAX), - - - Source current (TL=0)

PMM-MD-23220-21 PMM-MD-23221-21

● SH3533-12U □ □ : 24V

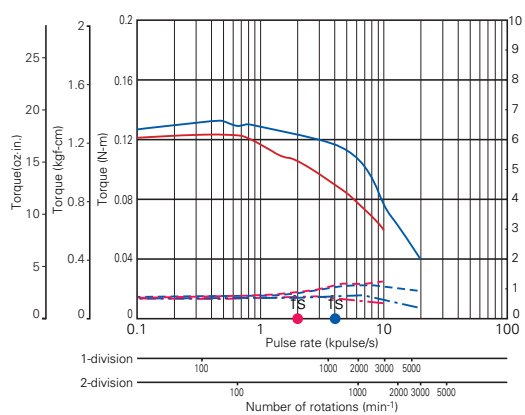

Source voltage: DC24V, Operating current :1.2A/phase
 — Pull-Out torque [$J_{L1}=0.33 \times 10^{-4} \text{kg}\cdot\text{m}^2$ (1.80 oz-in²) Use the rubber coupling]
 - - - Source current (TL=MAX), - - - Source current (TL=0)

● SH3533-12U □ □ : 36V

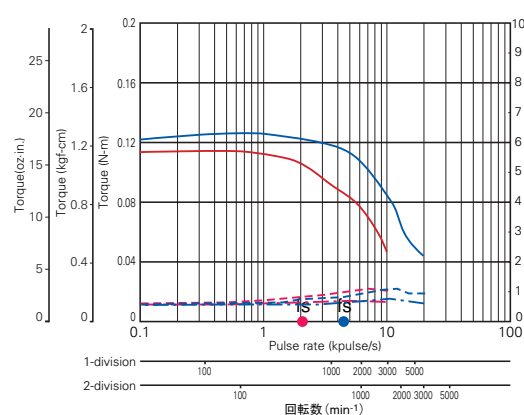

Source voltage: DC36V, Operating current :1.2A/phase 2-phase energization (full-step)
 — Pull-Out torque [$J_{L1}=0.33 \times 10^{-4} \text{kg}\cdot\text{m}^2$ (1.80 oz-in²) Use the rubber coupling]
 - - - Source current (TL=MAX), - - - Source current (TL=0)

● SH3537-12U □ □ : 24V

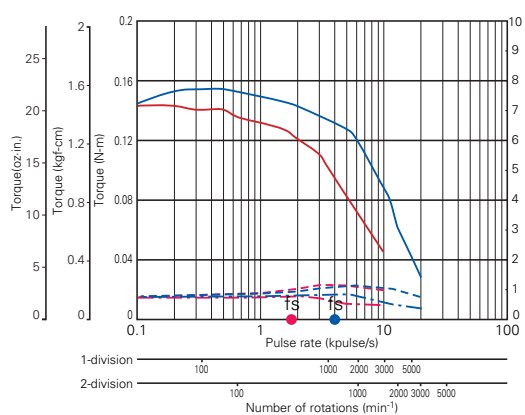

Source voltage: DC36V, Operating current :1.2A/phase 2-phase energization (full-step)
 — Pull-Out torque [$J_{L1}=0.33 \times 10^{-4} \text{kg}\cdot\text{m}^2$ (1.80 oz-in²) Use the rubber coupling]
 - - - Source current (TL=MAX), - - - Source current (TL=0)

● SH3537-12U □ □ : 36V

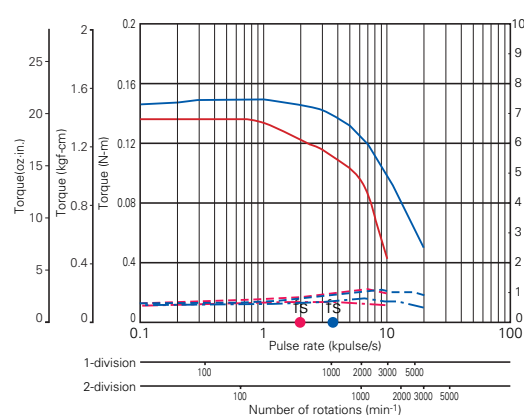

Source voltage: DC36V, Operating current :1.2A/phase 2-phase energization (full-step)
 — Pull-Out torque [$J_{L1}=0.33 \times 10^{-4} \text{kg}\cdot\text{m}^2$ (1.80 oz-in²) Use the rubber coupling]
 - - - Source current (TL=MAX), - - - Source current (TL=0)

PMM-BA-4803
 PMM-BA-4804
 PMM-UA-4303
 PMM-UA-4304
 PMM-MD-23210-10
 PMM-MD-23211-10
 PMM-MD-23220-21
 PMM-MD-23221-21
 PMM-MD-23120

Pulse Rate-Torque Characteristics/Pulse Rate-Power Current Characteristics

fs: No load maximum starting pulse rate. ■ 1-division is specified ■ 2-division is specified

PMM-MD-23220-21 PMM-MD-23221-21

● SH3552-12U □□ : 24V

● SH3552-12U □□ : 36V

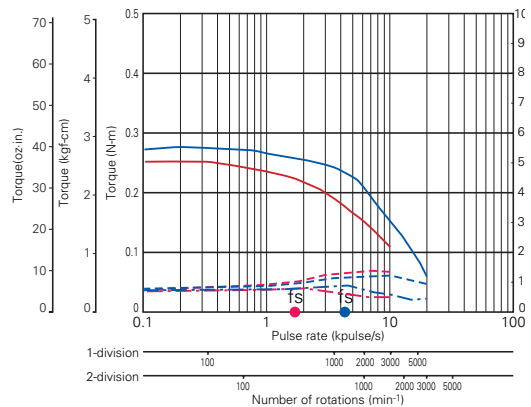
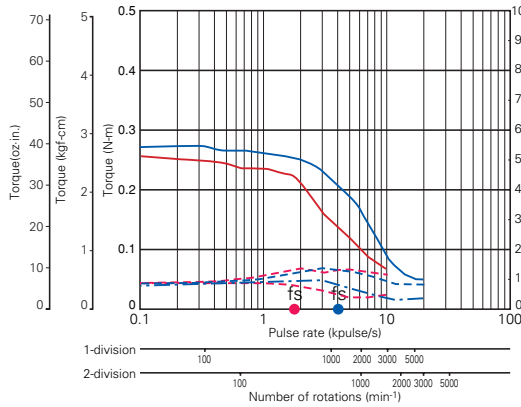

Source voltage: DC24V, Operating current :1.2A/phase 2-phase energization (full-step)
 — Pull-Out torque [$JL_1=0.33 \times 10^{-4} \text{kg}\cdot\text{m}^2$ (1.80 oz-in²) Use the rubber coupling]
 - - - Source current (TL=MAX), - - - Source current (TL=0)

Source voltage: DC36V, Operating current :1.2A/phase 2-phase energization (full-step)
 — Pull-Out torque [$JL_1=0.33 \times 10^{-4} \text{kg}\cdot\text{m}^2$ (1.80 oz-in²) Use the rubber coupling]
 - - - Source current (TL=MAX), - - - Source current (TL=0)

● 103H5205-04 □□ : 24V

● 103H5205-04 □□ : 36V

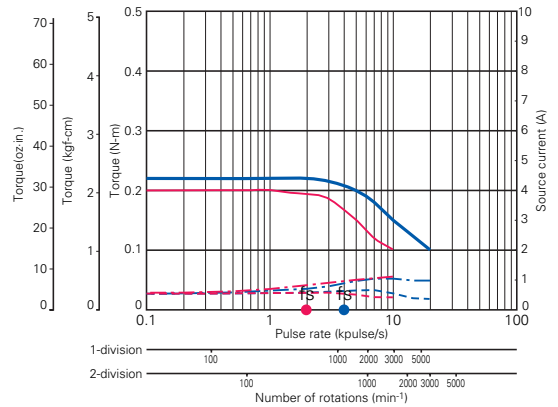
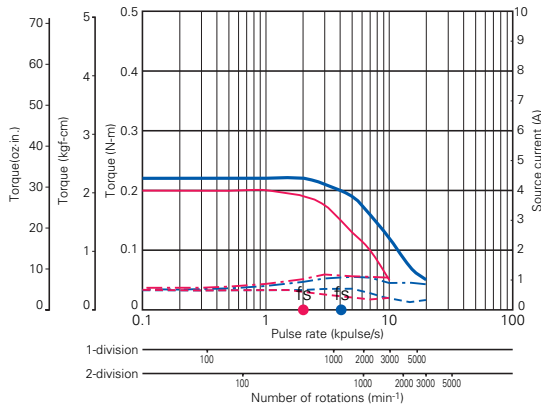

Source voltage: DC24V, Operating current :1.2A/phase
 — Pull-Out torque [$JL_1=0.94 \times 10^{-4} \text{kg}\cdot\text{m}^2$ (5.14 oz-in²) Use the rubber coupling]
 - - - Source current (TL=MAX), - - - Source current (TL=0)

Source voltage: DC36V, Operating current :1.2A/phase
 — Pull-Out torque [$JL_1=0.94 \times 10^{-4} \text{kg}\cdot\text{m}^2$ (5.14 oz-in²) Use the rubber coupling]
 - - - Source current (TL=MAX), - - - Source current (TL=0)

● 103H5208-04 □□ : 24V

● 103H5208-04 □□ : 36V

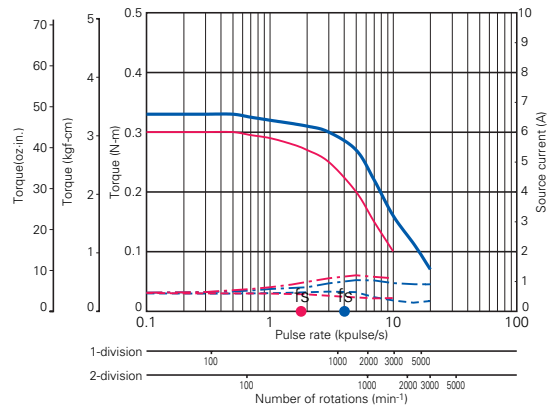
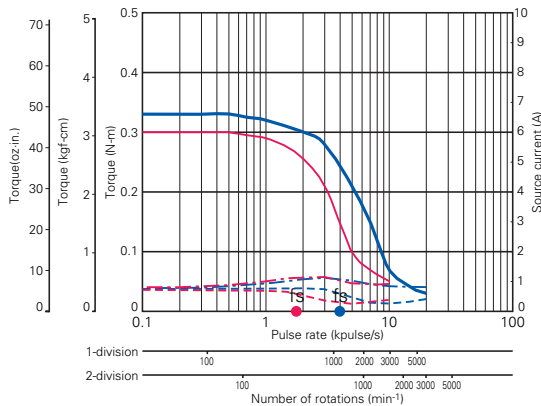

Source voltage: DC24V, Operating current :1.2A/phase
 — Pull-Out torque [$JL_1=0.94 \times 10^{-4} \text{kg}\cdot\text{m}^2$ (5.14 oz-in²) Use the rubber coupling]
 - - - Source current (TL=MAX), - - - Source current (TL=0)

Source voltage: DC36V, Operating current :1.2A/phase
 — Pull-Out torque [$JL_1=0.94 \times 10^{-4} \text{kg}\cdot\text{m}^2$ (5.14 oz-in²) Use the rubber coupling]
 - - - Source current (TL=MAX), - - - Source current (TL=0)

Pulse Rate-Torque Characteristics/Pulse Rate-Power Current Characteristics

fs: No load maximum starting pulse rate. ■ 1-division is specified ■ 2-division is specified

PMM-MD-23220-21 PMM-MD-23221-21

● 103H5209-04 □ □ : 24V

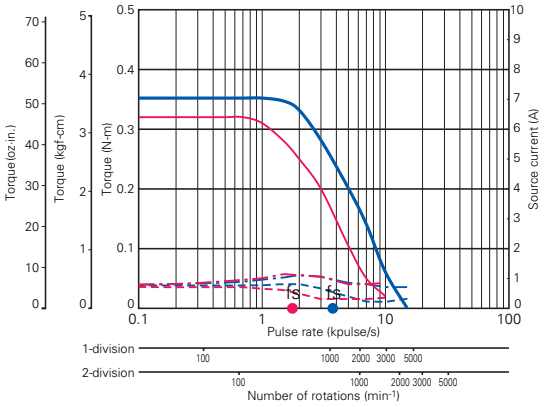

Source voltage: DC24V, Operating current : 1.2A/phase
 — Pull-Out torque ($J_{L1}=0.94 \times 10^{-4} \text{kg}\cdot\text{m}^2$ (5.14 oz-in²) Use the rubber coupling)
 - - - Source current (TL=MAX), - - - Source current (TL=0)

● 103H5209-04 □ □ : 36V

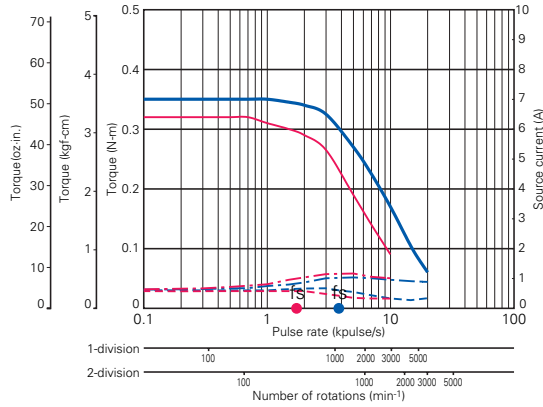

Source voltage: DC36V, Operating current : 1.2A/phase
 — Pull-Out torque ($J_{L1}=0.94 \times 10^{-4} \text{kg}\cdot\text{m}^2$ (5.14 oz-in²) Use the rubber coupling)
 - - - Source current (TL=MAX), - - - Source current (TL=0)

● 103H5210-04 □ □ : 24V

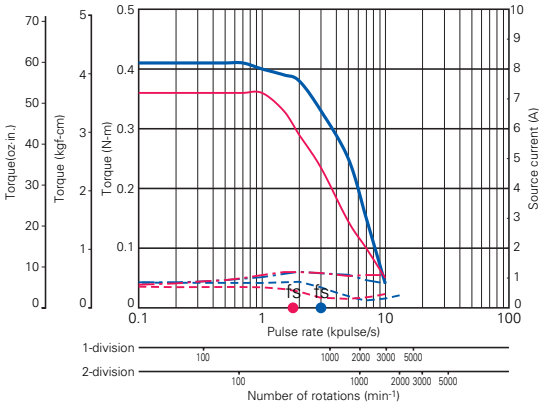

Source voltage: DC24V, Operating current : 1.2A/phase
 — Pull-Out torque ($J_{L1}=0.94 \times 10^{-4} \text{kg}\cdot\text{m}^2$ (5.14 oz-in²) Use the rubber coupling)
 - - - Source current (TL=MAX), - - - Source current (TL=0)

● 103H5210-04 □ □ : 36V

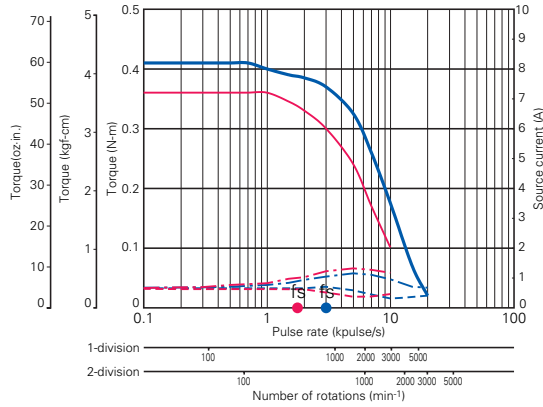

Source voltage: DC36V, Operating current : 1.2A/phase
 — Pull-Out torque ($J_{L1}=0.94 \times 10^{-4} \text{kg}\cdot\text{m}^2$ (5.14 oz-in²) Use the rubber coupling)
 - - - Source current (TL=MAX), - - - Source current (TL=0)

PMM-MD-23220-10 PMM-MD-23221-10

● 103H6701-04 □ □ : 24V

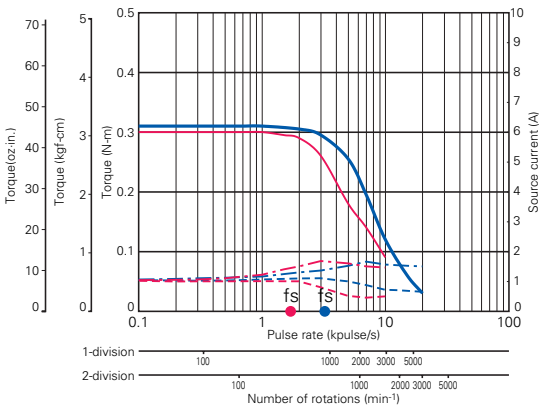

Source voltage: DC24V, Operating current : 1.2A/phase
 — Pull-Out torque ($J_{L1}=0.94 \times 10^{-4} \text{kg}\cdot\text{m}^2$ (5.14 oz-in²) Use the rubber coupling)
 - - - Source current (TL=MAX), - - - Source current (TL=0)

● 103H6701-04 □ □ : 36V

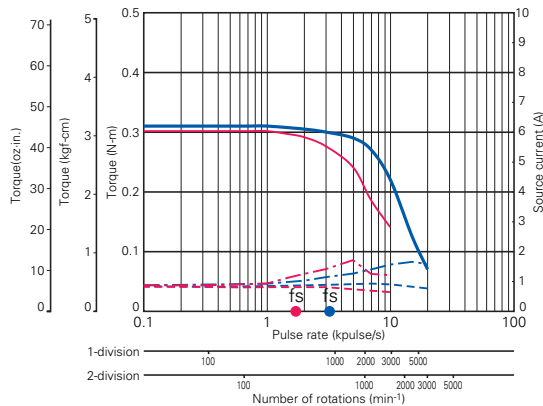

Source voltage: DC36V, Operating current : 1.2A/phase
 — Pull-Out torque ($J_{L1}=0.94 \times 10^{-4} \text{kg}\cdot\text{m}^2$ (5.14 oz-in²) Use the rubber coupling)
 - - - Source current (TL=MAX), - - - Source current (TL=0)

PMM-BA-4803
PMM-BA-4804
PMM-UA-4303
PMM-UA-4304
PMM-MD-2320-10/2321-10
PMM-MD-2320-21/2321-21
PMM-MD-2320-10/2321-10
PMM-MD-23120

Pulse Rate-Torque Characteristics/Pulse Rate-Power Current Characteristics

fs: No load maximum starting pulse rate. ■ 1-division is specified ■ 2-division is specified

PMM-MD-23220-10 PMM-MD-23221-10

● 103H6703-04 □ □ : 24V

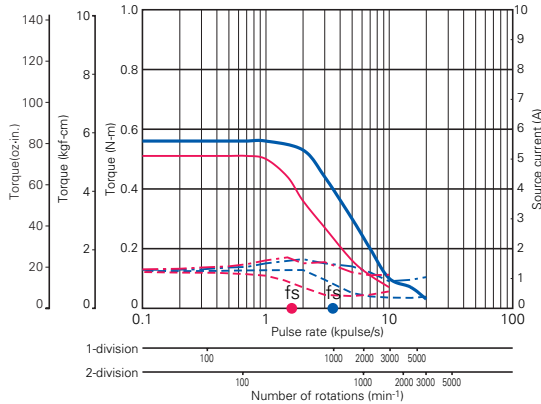

Source voltage: DC24V, Operating current : 2A/phase
 — Pull-Out torque [$JL_1=0.94 \times 10^{-4} \text{kg}\cdot\text{m}^2$ (5.14 oz-in²) Use the rubber coupling]
 - - - Source current (TL=MAX), - - - Source current (TL=0)

● 103H6703-04 □ □ : 36V

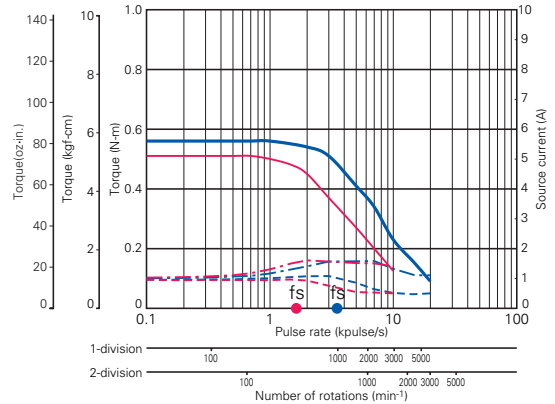

Source voltage: DC36V, Operating current : 2A/phase
 — Pull-Out torque [$JL_1=0.94 \times 10^{-4} \text{kg}\cdot\text{m}^2$ (5.14 oz-in²) Use the rubber coupling]
 - - - Source current (TL=MAX), - - - Source current (TL=0)

● 103H6704-04 □ □ : 24V

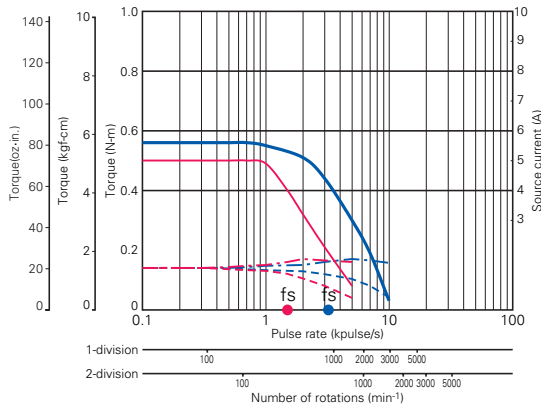

Source voltage: DC24V, Operating current : 2A/phase
 — Pull-Out torque [$JL_1=0.94 \times 10^{-4} \text{kg}\cdot\text{m}^2$ (5.14 oz-in²) Use the rubber coupling]
 - - - Source current (TL=MAX), - - - Source current (TL=0)

● 103H6704-04 □ □ : 36V

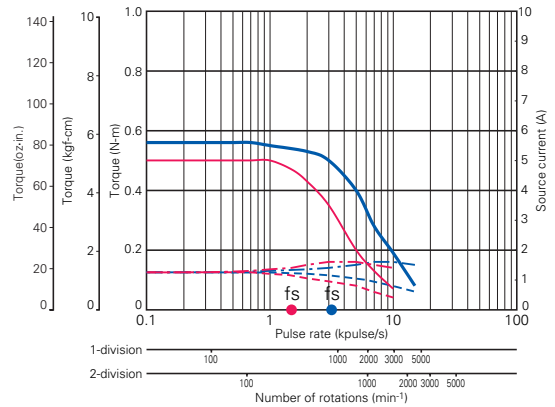

Source voltage: DC36V, Operating current : 2A/phase
 — Pull-Out torque [$JL_1=0.94 \times 10^{-4} \text{kg}\cdot\text{m}^2$ (5.14 oz-in²) Use the rubber coupling]
 - - - Source current (TL=MAX), - - - Source current (TL=0)

● 103H7121-04 □ □ : 24V

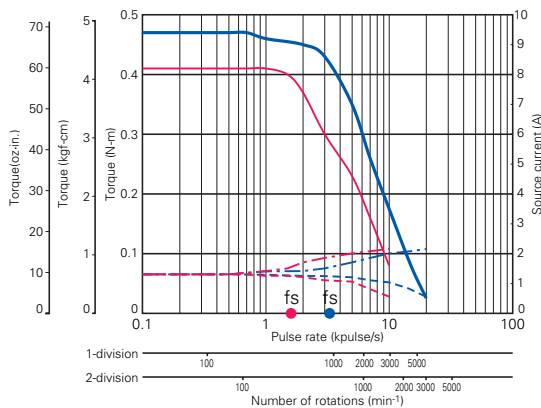

Source voltage: DC24V, Operating current : 2A/phase
 — Pull-Out torque [$JL_1=0.94 \times 10^{-4} \text{kg}\cdot\text{m}^2$ (5.14 oz-in²) Use the rubber coupling]
 - - - Source current (TL=MAX), - - - Source current (TL=0)

● 103H7121-04 □ □ : 36V

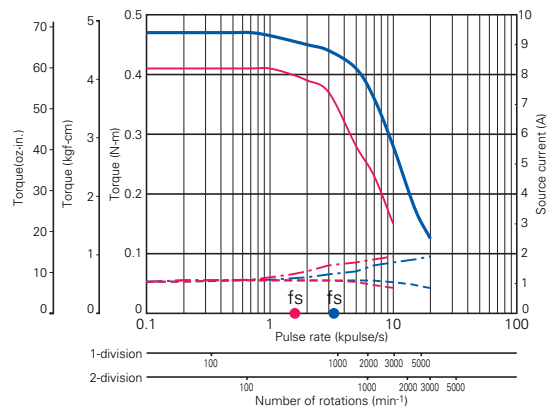

Source voltage: DC36V, Operating current : 2A/phase
 — Pull-Out torque [$JL_1=0.94 \times 10^{-4} \text{kg}\cdot\text{m}^2$ (5.14 oz-in²) Use the rubber coupling]
 - - - Source current (TL=MAX), - - - Source current (TL=0)

Pulse Rate-Torque Characteristics/Pulse Rate-Power Current Characteristics

PMM-MD-23220-10 PMM-MD-23221-10

fs: No load maximum starting pulse rate. ■ 1-division is specified ■ 2-division is specified

● 103H7123-04 □□ : 24V

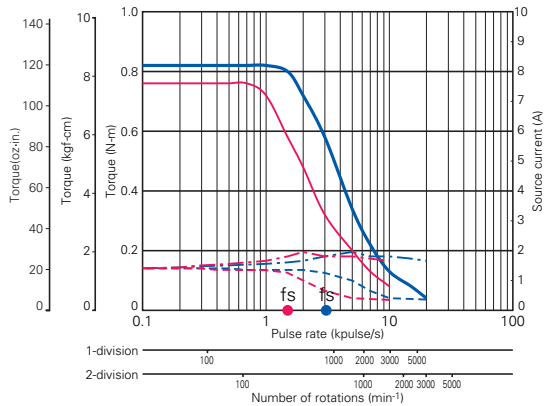

Source voltage: DC24V, Operating current : 2A/phase
 — Pull-Out torque ($J_{L1}=2.6 \times 10^{-4} \text{kg}\cdot\text{m}^2$ (14.22 oz-in²) Use the rubber coupling)
 - - - Source current (TL=MAX), - - - Source current (TL=0)

● 103H7123-04 □□ : 36V

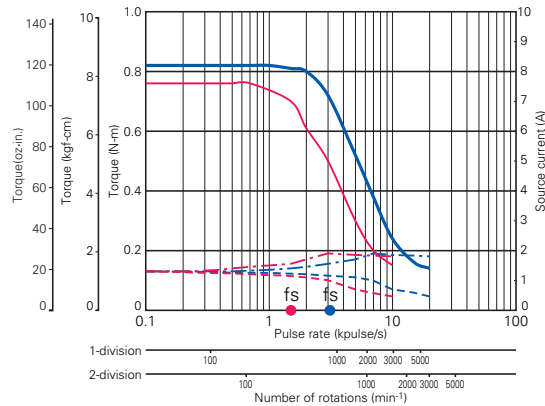

Source voltage: DC24V, Operating current : 2A/phase
 — Pull-Out torque ($J_{L1}=2.6 \times 10^{-4} \text{kg}\cdot\text{m}^2$ (14.22 oz-in²) Use the rubber coupling)
 - - - Source current (TL=MAX), - - - Source current (TL=0)

● 103H7124-04 □□ : 24V

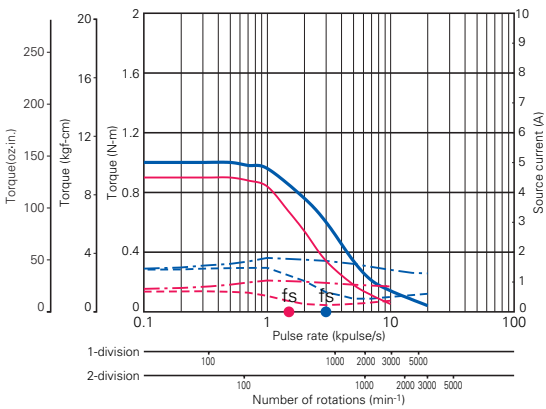

Source voltage: DC24V, Operating current : 2A/phase
 — Pull-Out torque ($J_{L1}=2.6 \times 10^{-4} \text{kg}\cdot\text{m}^2$ (14.22 oz-in²) Use the rubber coupling)
 - - - Source current (TL=MAX), - - - Source current (TL=0)

● 103H7124-04 □□ : 36V

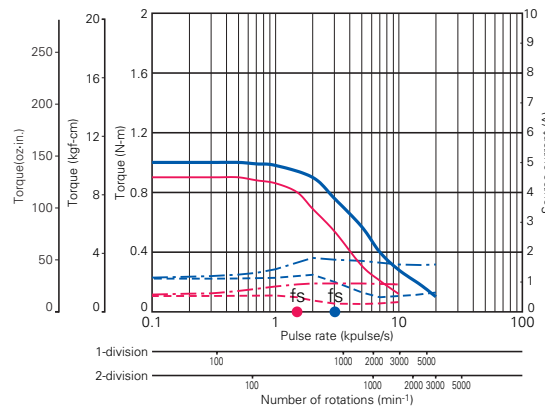

Source voltage: DC24V, Operating current : 2A/phase
 — Pull-Out torque ($J_{L1}=2.6 \times 10^{-4} \text{kg}\cdot\text{m}^2$ (14.22 oz-in²) Use the rubber coupling)
 - - - Source current (TL=MAX), - - - Source current (TL=0)

● 103H7126-04 □□ : 24V

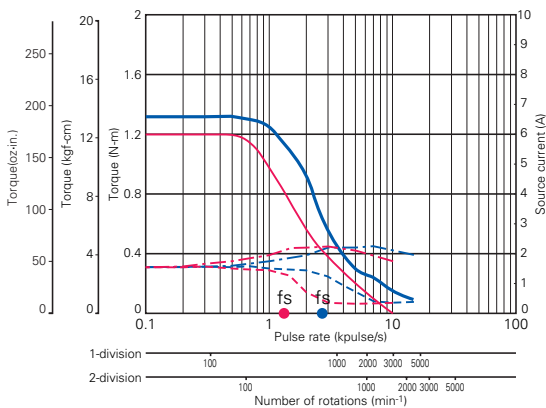

Source voltage: DC24V, Operating current : 2A/phase
 — Pull-Out torque ($J_{L1}=2.6 \times 10^{-4} \text{kg}\cdot\text{m}^2$ (14.22 oz-in²) Use the rubber coupling)
 - - - Source current (TL=MAX), - - - Source current (TL=0)

● 103H7126-04 □□ : 36V

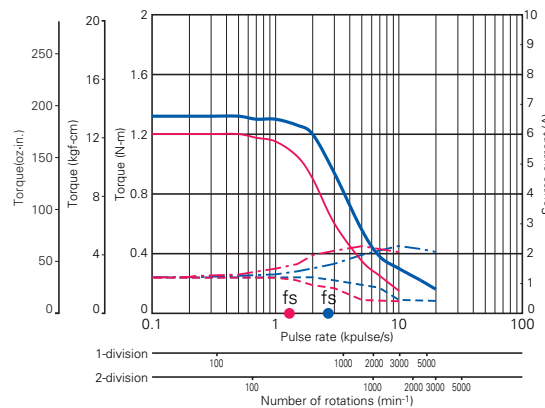

Source voltage: DC24V, Operating current : 2A/phase
 — Pull-Out torque ($J_{L1}=2.6 \times 10^{-4} \text{kg}\cdot\text{m}^2$ (14.22 oz-in²) Use the rubber coupling)
 - - - Source current (TL=MAX), - - - Source current (TL=0)

PMM-BA-4803
PMM-BA-4804

PMM-UA-4303
PMM-UA-4304

PMM-MD-23210-10
PMM-MD-23210-21
PMM-MD-23210-22
PMM-MD-23210-23

PMM-MD-23120

Pulse Rate-Torque Characteristics/Pulse Rate-Power Current Characteristics

PMM-MD-23220-10 PMM-MD-23221-10

fs: No load maximum starting pulse rate. ■ 1-division is specified ■ 2-division is specified

● 103H7821-04 □ □ : 24V

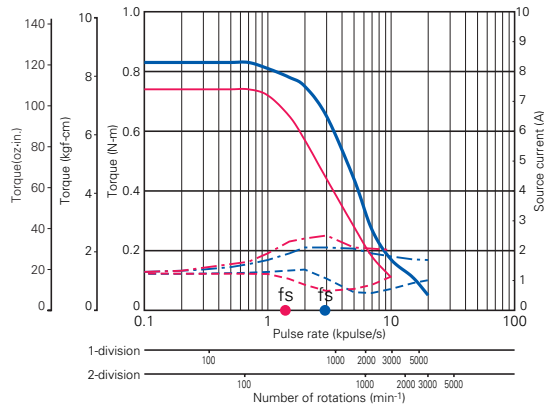

Source voltage: DC24V, Operating current 2A/phase
 — Pull-Out torque [$JL_1=2.6 \times 10^{-4} \text{kg}\cdot\text{m}^2$ (14.22 oz-in²) Use the rubber coupling]
 - - - Source current (TL=MAX), - - - Source current (TL=0)

● 103H7821-04 □ □ : 36V

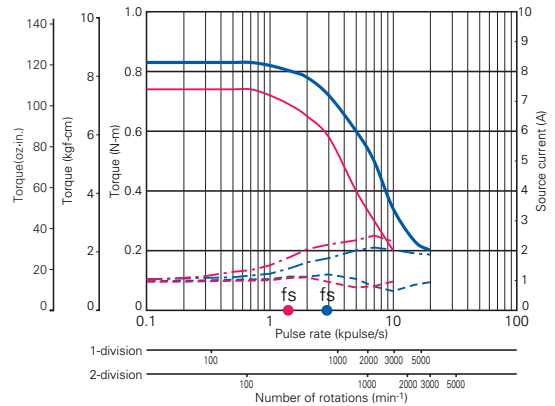

Source voltage: DC24V, Operating current 2A/phase
 — Pull-Out torque [$JL_1=2.6 \times 10^{-4} \text{kg}\cdot\text{m}^2$ (14.22 oz-in²) Use the rubber coupling]
 - - - Source current (TL=MAX), - - - Source current (TL=0)

● 103H7822-04 □ □ : 24V

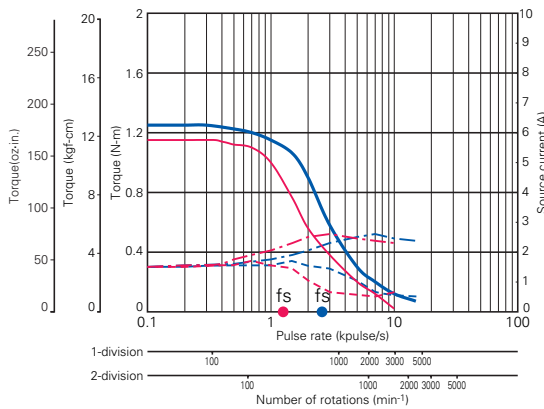

Source voltage: DC24V, Operating current 2A/phase
 — Pull-Out torque [$JL_1=2.6 \times 10^{-4} \text{kg}\cdot\text{m}^2$ (14.22 oz-in²) Use the rubber coupling]
 - - - Source current (TL=MAX), - - - Source current (TL=0)

● 103H7822-04 □ □ : 36V

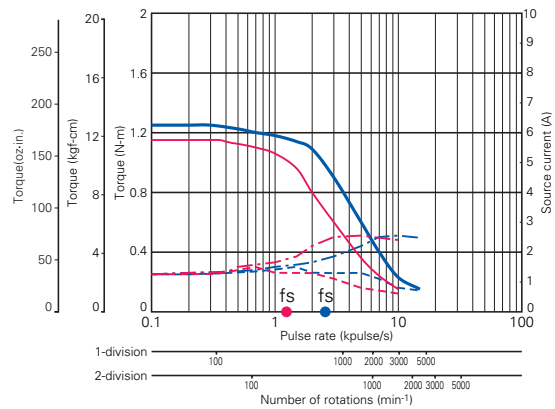

Source voltage: DC24V, Operating current 2A/phase
 — Pull-Out torque [$JL_1=2.6 \times 10^{-4} \text{kg}\cdot\text{m}^2$ (14.22 oz-in²) Use the rubber coupling]
 - - - Source current (TL=MAX), - - - Source current (TL=0)

● 103H7823-04 □ □ : 24V

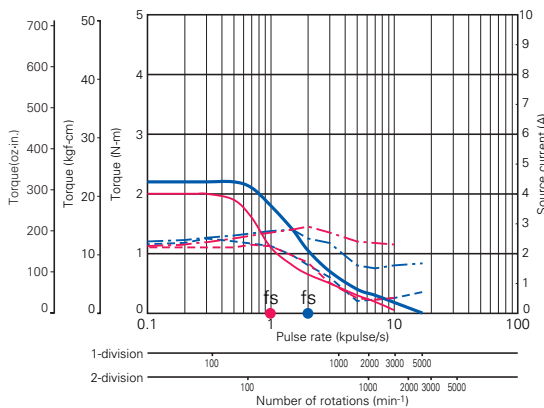

Source voltage: DC24V, Operating current 2A/phase
 — Pull-Out torque [$JL_1=7.4 \times 10^{-4} \text{kg}\cdot\text{m}^2$ (40.46 oz-in²) Use the rubber coupling]
 - - - Source current (TL=MAX), - - - Source current (TL=0)

● 103H7823-04 □ □ : 36V

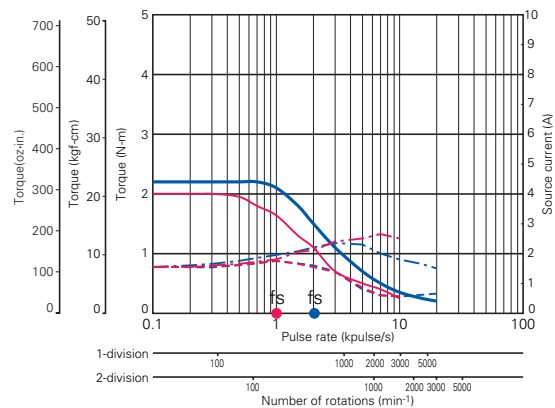

Source voltage: DC24V, Operating current 2A/phase
 — Pull-Out torque [$JL_1=7.4 \times 10^{-4} \text{kg}\cdot\text{m}^2$ (40.46 oz-in²) Use the rubber coupling]
 - - - Source current (TL=MAX), - - - Source current (TL=0)

Pulse Rate-Torque Characteristics/Pulse Rate-Power Current Characteristics

PMM-MD-23220-10 PMM-MD-23221-10

fs: No load maximum starting pulse rate. ■ 1-division is specified ■ 2-division is specified

● 103H8221-04 □ □ : 24V

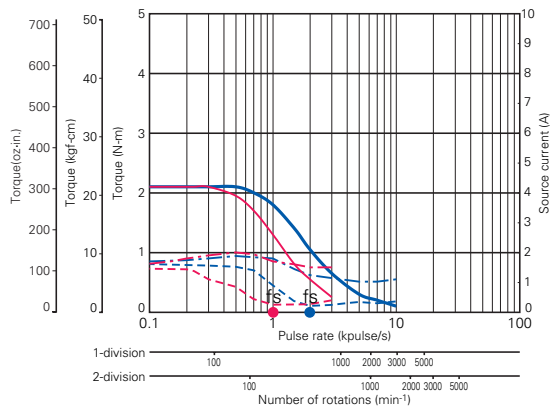

Source voltage: DC24V, Operating current : 2A/phase
 — Pull-Out torque [$J_{L1}=7.4 \times 10^{-4} \text{kg}\cdot\text{m}^2$ (40.46 oz-in²) Use the rubber coupling]
 - - - Source current (TL=MAX), - - - Source current (TL=0)

● 103H8221-04 □ □ : 36V

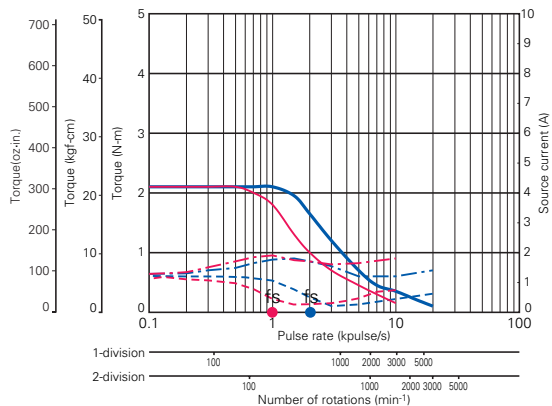

Source voltage: DC24V, Operating current : 2A/phase
 — Pull-Out torque [$J_{L1}=7.4 \times 10^{-4} \text{kg}\cdot\text{m}^2$ (40.46 oz-in²) Use the rubber coupling]
 - - - Source current (TL=MAX), - - - Source current (TL=0)

● 103H8222-04 □ □ : 24V

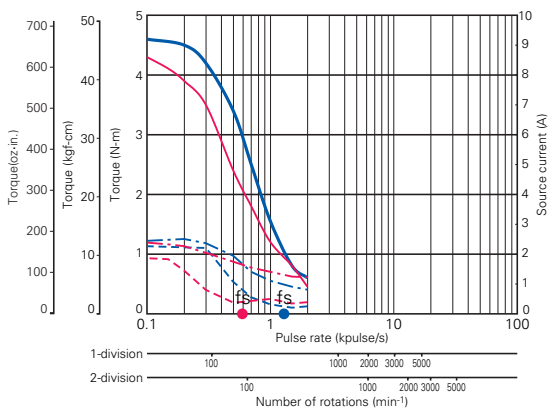

Source voltage: DC24V, Operating current : 2A/phase
 — Pull-Out torque [$J_{L1}=15.3 \times 10^{-4} \text{kg}\cdot\text{m}^2$ (83.65 oz-in²) Use the rubber coupling]
 - - - Source current (TL=MAX), - - - Source current (TL=0)

● 103H8222-04 □ □ : 36V

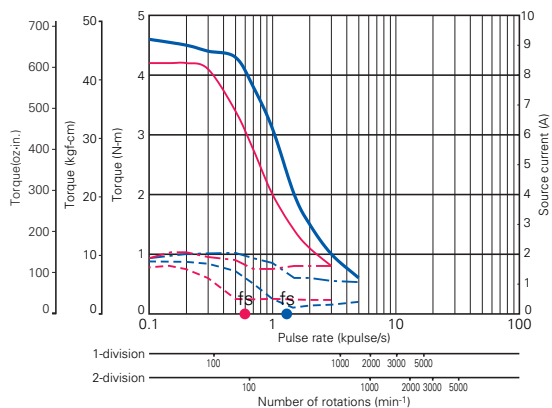

Source voltage: DC24V, Operating current : 2A/phase
 — Pull-Out torque [$J_{L1}=15.3 \times 10^{-4} \text{kg}\cdot\text{m}^2$ (83.65 oz-in²) Use the rubber coupling]
 - - - Source current (TL=MAX), - - - Source current (TL=0)

● 103H8223-04 □ □ : 24V

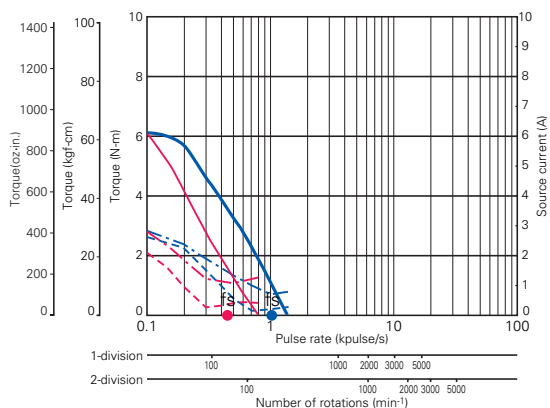

Source voltage: DC24V, Operating current : 2A/phase
 — Pull-Out torque [$J_{L1}=15.3 \times 10^{-4} \text{kg}\cdot\text{m}^2$ (83.65 oz-in²) Use the rubber coupling]
 - - - Source current (TL=MAX), - - - Source current (TL=0)

● 103H8223-04 □ □ : 36V

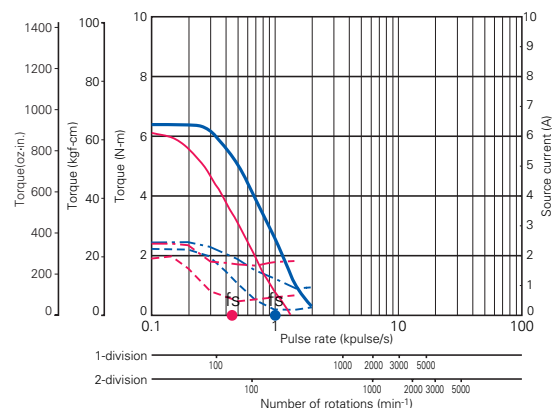

Source voltage: DC24V, Operating current : 2A/phase
 — Pull-Out torque [$J_{L1}=15.3 \times 10^{-4} \text{kg}\cdot\text{m}^2$ (83.65 oz-in²) Use the rubber coupling]
 - - - Source current (TL=MAX), - - - Source current (TL=0)

PMM-BA-4803
PMM-BA-4804

PMM-UA-4303
PMM-UA-4304

PMM-MD-23210-10
PMM-MD-23211-10

PMM-MD-23120

Option

● Connector set

PMM-MD-23210-10 (Photo coupler input method)

Model	Used for	Contents of set	Quantity	Manufacturer	Applicable wire size	Crimp tool number
PM-AP-009	I/O signal (CN1A)	Applicable housing:5051-08	1	Molex	AWG22~28	JHTR2262A JHTR2262J
		Applicable contact:2759PBGL	8			
PM-AP-053	Stepping motor (CN2)	Applicable housing:5051-06	1	Molex	AWG24~28	JHTR2262A JHTR2262J
		Applicable contact:5159PBTL	6			
		Applicable housing:PHR-6	1	J.S.T. MFG. CO., LTD.		YRS-240
		Applicable contact:SPH-002T-P0.5S	6			
PM-AP-013	DC power supply (CN3)	Applicable housing:5195-02	1	Molex	AWG18~24	JHTR5904
		Applicable contact:5194PBTL	2			

PMM-MD-23211-10 (CMOS input method)

Model	Used for	Contents of set	Quantity	Manufacturer	Applicable wire size	Crimp tool number
PM-AP-011	Power supply I/O signal (CN1B)	Applicable housing:5051-12	1	Molex	AWG22~28	JHTR2262A JHTR2262J
		Applicable contact:2759PBGL	12			
PM-AP-053	Stepping motor (CN2)	Applicable housing:5051-06	1	Molex	AWG24~28	JHTR2262A JHTR2262J
		Applicable contact:5159PBTL	6			
		Applicable housing:PHR-6	1	J.S.T. MFG. CO.,LTD		YRS-240
		Applicable contact:SPH-002T-P0.5S	6			

PMM-MD-23220-21 (Photo coupler input method)

Model	Used for	Contents of set	Quantity	Manufacturer	Applicable wire size	Crimp tool number
PM-AP-009	I/O signal (CN1A)	Applicable housing:5051-08	1	Molex	AWG22~28	JHTR2262A JHTR2262J
		Applicable contact:2759PBGL	8			
PM-AP-054	Stepping motor (CN2)	Applicable housing:5051-06	1	Molex	AWG22~28	JHTR2262A JHTR2262J
		Applicable contact:5159PBTL	6			
		Applicable housing:EHR-6	1	J.S.T. MFG. CO., LTD.		YRS-260
		Applicable contact:SEH-001T-P0.6	6			
PM-AP-013	DC Power supply (CN3)	Applicable housing:5195-02	1	Molex	AWG18~24	JHTR5904
		Applicable contact:5194PBTL	2			

PMM-MD-23221-21 (CMOS input method)

Model	Used for	Contents of set	Quantity	Manufacturer	Applicable wire size	Crimp tool number
PM-AP-011	Power supply I/O signal (CN1B)	Applicable housing:5051-12	1	Molex	AWG22~28	JHTR2262A JHTR2262J
		Applicable contact:2759PBGL	12			
PM-AP-054	Stepping motor (CN2)	Applicable housing:5051-06	1	Molex	AWG22~28	JHTR2262A JHTR2262J
		Applicable contact:5159PBTL	6			
		Applicable housing:EHR-6	1	J.S.T. MFG. CO., LTD.		YRS-260
		Applicable contact:SEH-001T-P0.6	6			

PMM-MD-23220-10 (Photo coupler input method)

Model	Used for	Contents of set	Quantity	Manufacturer	Applicable wire size	Crimp tool number
PM-AP-009	I/O signal (CN1A)	Applicable housing:5051-08	1	Molex	AWG22~28	JHTR2262A JHTR2262J
		Applicable contact:2759PBGL	8			
PM-AP-047 H782 □ type	Stepping motor (CN2)	Applicable housing:5051-06	1	Molex	AWG22	JHTR2262A
		Applicable contact:5159PBTL	6			
		Applicable housing:VHR-6N	1	J.S.T. MFG. CO., LTD.		YC-160R
		Applicable contact:SVH-21T-P1.1	6			
PM-AP-008 Other types		Applicable housing:5051-06	1	Molex	AWG22	JHTR2262A
		Applicable contact:5159PBTL	6			
PM-AP-013	DC Power supply (CN3)	Applicable housing:5195-02	1	Molex	AWG18~24	JHTR5904
		Applicable contact:5194PBTL	2			

PMM-MD-23221-10 (CMOS input method)

Model	Used for	Contents of set	Quantity	Manufacturer	Applicable wire size	Crimp tool number
PM-AP-011	Power supply I/O signal (CN1B)	Applicable housing:5051-12	1	Molex	AWG22~28	JHTR2262A JHTR2262J
		Applicable contact:2759PBGL	12			
PM-AP-047 H782 □ type	Stepping motor (CN2)	Applicable housing:5051-06	1	Molex	AWG22	JHTR2262A
		Applicable contact:5159PBTL	6			
		Applicable housing:VHR-6N	1	J.S.T. MFG. CO., LTD.		YC-160R
		Applicable contact:SVH-21T-P1.1	6			
PM-AP-008 Other types		Applicable housing:5051-06	1	Molex	AWG22	JHTR2262A
		Applicable contact:5159PBTL	6			

Option

● Connector cable

PMM-MD-23210-10 (Photo coupler input method)

PMM-MD-23220-21 (Photo coupler input method)

PMM-MD-23220-10 (Photo coupler input method)

Model	Used for
PM-C08S0100-01	I/O signal (CN1A) connector cable
PM-C02P0100-02	DC power supply (CN3) connector cable
PM-C06M0100-□□	Stepping motor (CN2) connector cable

PMM-MD-23211-10 (CMOS input method)

PMM-MD-23221-21 (CMOS input method)

PMM-MD-23221-10 (CMOS input method)

Model	Used for
PM-C12T0100-01	DC power supply, I/O signal(CN1B) connector cable
PM-C06M0100-□□	Stepping motor (CN2) connector cable

□□... is 01, 03, 05 or 06. (Refer to separate table 1.)

- The connector cables consist of each interface connector with a 1m cable assembled.

Model No. of stepping motor cable (Separate Table 1)

Serial No.	Stepping motor model No.
01	103H6701-04□□
	103H6703-04□□
	103H6704-53□□
	103H7121-04□□
	103H7123-04□□
	103H7124-04□□
	103H7126-04□□
	103H8221-04□□
	103H8222-04□□
103H8223-04□□	

Serial No.	Stepping motor model No.
03	103H7821-04□□
	103H7822-04□□
	103H7823-04□□
05	103H3215-52□□
	103H5205-04□□
06	103H5208-04□□
	103H5209-04□□
	103H5210-04□□

● Cable 1 (Power source cable)

Driver side	
Pin No.	Color
1	Black
2	White

Model of cable	Length
PM-C02P0100-02	1m(39.37inch)

● Cable 2(Power source, signal cable)

Driver side	
Pin No.	Color
1	White
2	
3	Black
4	
5	White
6	Black
7	Blue
8	
9	
10	
11	
12	

Model of cable	Length
PM-C12T0100-01	1m(39.37inch)

Option

● Cable 3 (Signal cable)

Driver side	
Pin No.	Color
1	Blue
2	
3	
4	
5	
6	
7	
8	

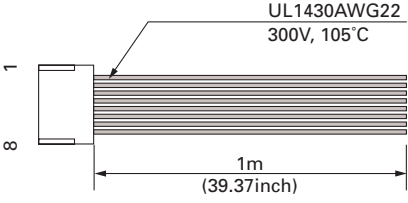

Model of cable	Length
PM-C08S0100-01	1m(39.37inch)

● Cable 4(Stepping motor extension cable)

Driver side	
Pin No.	Color
1	White
2	Black
3	Orange
4	Blue
5	Red
6	Yellow

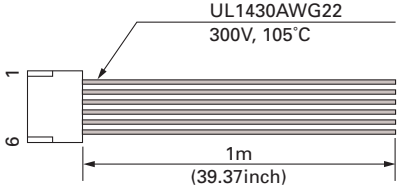

Model of cable	Length
PM-C06M0100-01	1m(39.37inch)

Applicable stepping motor	
103H6701-04□0	103H7124-04□0
103H6703-04□0	103H7126-04□0
103H6704-04□0	103H8221-04□1
103H7121-04□0	103H8222-04□1
103H7123-04□0	103H8223-04□1

● Cable 5 (Stepping motor extension cable)

Driver side	
Pin No.	Color
1	White
2	Black
3	Orange
4	Blue
5	Red
6	Yellow

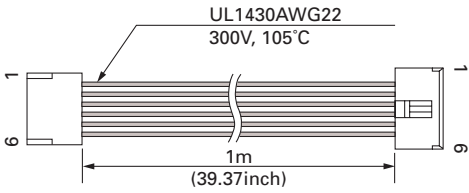

Stepping motor side	
Pin No.	Color
1	White
2	Orange
3	Blue
4	Red
5	Yellow
6	Black

Model of cable	Length
PM-C06M0100-03	1m(39.37inch)

Applicable stepping motor	
103H7821-04□0	
103H7822-04□0	
103H7823-04□0	

● Cable 6 (Stepping motor extension cable)

Driver side	
Pin No.	Color
1	White
2	Black
3	Orange
4	Blue
5	Red
6	Yellow

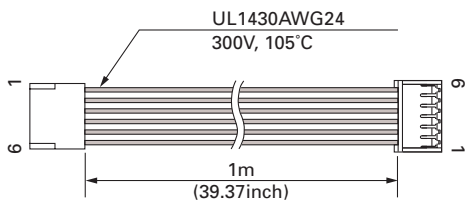

Stepping motor side	
Pin No.	Color
1	Black
2	Blue
3	Yellow
4	Orange
5	Red
6	White

Model of cable	Length
PM-C06M0100-05	1m(39.37inch)

Applicable stepping motor	
103H3215-52□0	

● Cable 7(Stepping motor extension cable)

Driver side	
Pin No.	Color
1	White
2	Black
3	Orange
4	Blue
5	Red
6	Yellow

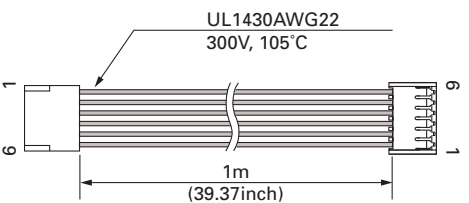

Stepping motor side	
Pin No.	Color
1	White
2	Orange
3	Blue
4	Yellow
5	Red
6	Black

Model of cable	Length
PM-C06M0100-06	1m(39.37inch)

Applicable stepping motor	
103H5205-04□0	
103H5208-04□0	
103H5209-04□0	
103H5210-04□0	

PMM-BA-4803
PMM-BA-4804

PMM-UA-4303
PMM-UA-4304

PMM-ID-3320-10/3321-10
PMM-ID-3320-21/3321-21
PMM-ID-3320-10/3321-10

PMM-ID-23120

2-phase Stepping Driver



PMM-MD-23120-10

DC24V/36V

Unipolar type

(Applicable motor rated current 1.2A/phase, 2A/phase)

Micro-step (200 X 1~180 divisions)

(Smooth operation and low vibration even at low speeds.)

● Applicable motor



Standard combined stepping motors

Dimensions of stepping motor	Stepping motor model number		Rated current [A/phase]	Holding torque [N·m(oz·in)]	Rotor inertia [x 10 ⁻⁴ kg·m ² (oz·in ²)]	Mass(Weight) [kg(lbs)]	Page
	Single shaft	Double shaft					
□42mm	103H5205-0440	103H5205-0410	1.2	0.2(28.32)	0.036(0.20)	0.23(0.51)	69 Page
	103H5208-0440	103H5208-0410	1.2	0.3(42.48)	0.056(0.31)	0.29(0.64)	
	103H5209-0440	103H5209-0410	1.2	0.32(45.31)	0.062(0.34)	0.31(0.68)	
	103H5210-0440	103H5210-0410	1.2	0.37(52.39)	0.074(0.40)	0.37(0.82)	
□50mm	103H6701-0440	103H6701-0410	2	0.28(39.6)	0.057(0.31)	0.35(0.77)	75 Page
	103H6703-0440	103H6703-0410	2	0.49(69.4)	0.118(0.65)	0.5(1.10)	
	103H6704-0440	103H6704-0410	2	0.52(73.6)	0.14(0.77)	0.5(1.10)	
□56mm	103H7121-0440	103H7121-0410	2	0.39(55.2)	0.1(0.55)	0.47(1.04)	79 Page
	103H7123-0440	103H7123-0410	2	0.83(117.5)	0.21(1.15)	0.65(1.43)	
	103H7124-0440	103H7124-0410	2	0.98(138.8)	0.245(1.34)	0.8(1.76)	
	103H7126-0440	103H7126-0410	2	1.27(179.8)	0.36(1.97)	0.98(2.16)	
□60mm	103H7821-0440	103H7821-0410	2	0.78(110.5)	0.275(1.50)	0.6(1.32)	87 Page
	103H7822-0440	103H7822-0410	2	1.17(165.7)	0.4(2.19)	0.77(1.70)	
	103H7823-0440	103H7823-0410	2	2.1(297.4)	0.84(4.59)	1.34(2.95)	
ø86mm	103H8221-0441	103H8221-0411	2	2.15(304.5)	1.45(7.93)	1.5(3.31)	91 Page
	103H8222-0441	103H8222-0411	2	4.13(584.8)	2.9(15.86)	2.5(5.51)	
	103H8223-0441	103H8223-0411	2	6.27(887.9)	4.4(24.06)	3.5(7.72)	

- For information about the general specifications and dimensions of each stepping motor, refer to its page.

Specifications of PM Driver

Item		PMM-MD-23120-10	
Basic specifications	Environment	Input source	DC24V/36V±10%
		Source current	3A
		Rated current	2A/phase (Changeable to 1.2A/phase, refer to Page 46)
		Operating ambient temperature	0~+50°C
		Conservation temperature	-20~+70°C
		Operating ambient humidity	35~85% RH (no condensation)
		Conservation humidity	10~90% RH (no condensation)
		Vibration resistance	4.9m/s ² Frequency range 10~55Hz, Direction: along X,Y and Z axes, for 2 hours each.
		Impact resistance	Considering the NDS-C-0110 standard section 3.2.2 division "C", not influenced.
		Withstand voltage	Not influenced when AC500V is applied between power input terminal and cabinet for one minute.
Insulation resistance	10MΩ MIN. measured with DC500V megohmmeter between input terminal and cabinet.		
Mass(Weight)	0.6kg(1.32lbs)		
Function	Selection, setting function		
	Pulse input mode selection— DIP switches enables selection of Pulse and direction and 2-input mode. Resolution setting— Rotary switches enables 8 divisions ranging from 1~180 resolutions. Power down — External signal input enables to turn off the current that flows through the stepping motor. Automatic current down selection— Automatic current down function can be selected. Resolution selection— External signal input enables to select 2 resolutions. Driving current switch setting— The rotary switch enables to set driving current of the stepping motor from rated current to 0%.		
I/O signals	Signal Name (Brevity code)	Pin No. (CN3)	
	CW pulse Input signal (CW)	1	In the 2-input mode, inputs driving pulses to rotate in CW direction.
		2	
	(CK)		In the Pulse and direction mode, inputs driving pulse train to rotate the step motor rotation. Photo coupler input method, input resistance 330Ω Input signal voltage: H = 4.0 to 5.5V, L = 0 to 0.5V Maximum input frequency:20kpulse/s
	CCW pulse Input signal (CCW)	3	In the 2-input mode, inputs driving pulses to rotate in CCW direction.
		4	
	(U/D)		In the Pulse and direction mode, inputs rotation direction signals to the stepping motor. Internal photo coupler ON (CMOS type: "H" level:) — CW direction Internal photo coupler OFF (CMOS type: "L" level)— CCW direction. Photo coupler input method, input resistance 330Ω Input signal voltage: H = 4.0 to 5.5V, L = 0 to 0.5V Maximum input frequency:20kpulse/s
Step angle setting selection input (S. SEL)	5	Input S.SEL signal to select step angle selection rotary switch (S.SEL). S.SEL input signal ON (Internal photo coupler ON) — SEL2 setting is enabled. S.SEL input signal OFF (Internal photo coupler OFF) — SEL1 setting is enabled. Photo coupler input method, input resistance 330Ω Input signal voltage: H = 4.0 to 5.5V, L = 0 to 0.5V	
	6		
Power down input signal (PD)	7	Inputs PD signal to turn off the current that flows through the stepping motor. PD input signal ON (Internal photo coupler ON) — Power down function is enabled. PD input signal OFF (Internal photo coupler OFF) — Power down function is disabled. Photo coupler input method, input resistance 330Ω	
	8		

- Stepping motor rotation in the CW direction means clockwise rotation when facing the output shaft (the flange side) of the stepping motor. CCW direction means counterclockwise rotation when facing the same side.

Operation, Connection, and Function

● Input circuit configuration (CW, CCW)

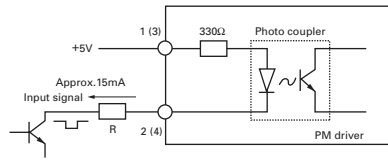

- Pulse duty 50% MAX.
- When the crest value of the input signal is 5V, the external limit resistance R must be 0Ω .
When the crest value of the input signal exceeds 5V, use the external limit resistance R to limit the input current to approximately 15mA.

Input signal specifications

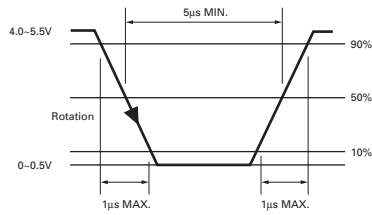

Timing of command pulse

- 2-input mode (CW, CCW)

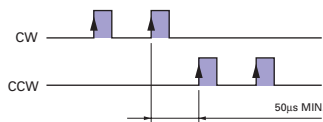

- The internal photo coupler turns ON within the and, at its rising edge to ON, the internal circuit (stepping motor) is activated.
- When applying the pulse to CW, turn OFF the CCW side internal photo coupler.
- When applying the pulse to CCW, turn OFF the CW side internal photo coupler.

- Pulse and direction mode (CK, U/D)

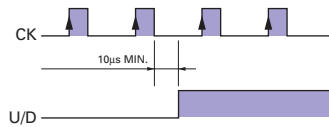

- The internal photo coupler turns ON within the and, at the rising edge to ON of the CK photo coupler, the internal circuit (stepping motor) is activated.
- Switching the input signal U/D shall be performed while the internal photo coupler on the CK side is OFF.

● Input circuit configuration (PD, S, SEL)

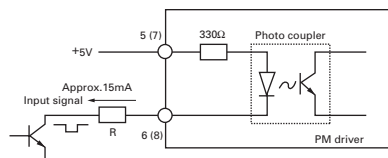

- When the crest value of the input signal is 5V, the external limit resistance R must be 0Ω .
When the crest value of the input signal exceeds 5V, use the external limit resistance R to limit the input current to approximately 15mA.

Operation, Connection, and Function

● PM driver component names

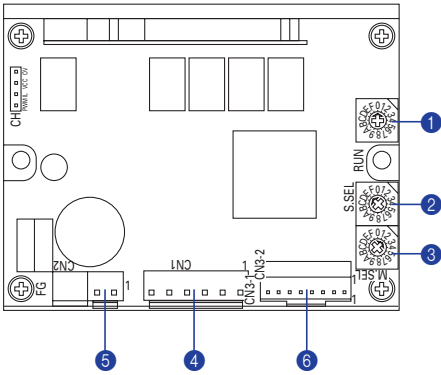

① Operation-current selection rotary switch (RUN)

Enable to select operating current value to stepping motor.

Dial	0	1	2	3	4	5	6	7
Stepping motor current (A/phase)	2.0	1.8	1.6	1.4	1.2	1.0	0.8	0.6
Dial	8	9	A	B	C	D	E	F
Stepping motor current (A/phase)	0	0	0	0	0	0	0	0

• Factory setting is "0".

② Stepping angle selection rotary switch (S.SEL)

Enable to select standard step angle of stepping motor for 8 divisions ranging from 1~180 resolutions.

Dial	0	1	2	3	4	5	6	7	
Division	SEL1	1	2	5	10	20	40	80	180
	SEL2	1	1	1	1	1	1	1	1
Dial	8	9	A	B	C	D	E	F	
Division	SEL1	1	2	5	10	20	40	80	180
	SEL2	2	2	2	2	2	2	2	2

• Factory setting is "E".

③ Mode selection rotary switch (M.SEL)

Enable to select every mode

Dial	0	1	2	3	4	5	6	7	8	9	A	B	C	D	E	F
Pulse input	2 input	<input type="checkbox"/>	<input type="checkbox"/>	<input type="checkbox"/>	<input type="checkbox"/>	<input type="checkbox"/>	<input type="checkbox"/>	<input type="checkbox"/>	<input type="checkbox"/>	<input type="checkbox"/>	<input type="checkbox"/>	<input type="checkbox"/>	<input type="checkbox"/>	<input type="checkbox"/>	<input type="checkbox"/>	<input type="checkbox"/>
	Pulse and direction	<input type="checkbox"/>	<input type="checkbox"/>	<input type="checkbox"/>	<input type="checkbox"/>	<input type="checkbox"/>	<input type="checkbox"/>	<input type="checkbox"/>	<input type="checkbox"/>	<input type="checkbox"/>	<input type="checkbox"/>	<input type="checkbox"/>	<input type="checkbox"/>	<input type="checkbox"/>	<input type="checkbox"/>	<input type="checkbox"/>
Automatic current down	OFF	<input type="checkbox"/>	<input type="checkbox"/>	<input type="checkbox"/>	<input type="checkbox"/>	<input type="checkbox"/>	<input type="checkbox"/>	<input type="checkbox"/>	<input type="checkbox"/>	<input type="checkbox"/>	<input type="checkbox"/>	<input type="checkbox"/>	<input type="checkbox"/>	<input type="checkbox"/>	<input type="checkbox"/>	<input type="checkbox"/>
	ON	<input type="checkbox"/>	<input type="checkbox"/>	<input type="checkbox"/>	<input type="checkbox"/>	<input type="checkbox"/>	<input type="checkbox"/>	<input type="checkbox"/>	<input type="checkbox"/>	<input type="checkbox"/>	<input type="checkbox"/>	<input type="checkbox"/>	<input type="checkbox"/>	<input type="checkbox"/>	<input type="checkbox"/>	<input type="checkbox"/>
Low vibration method	OFF	<input type="checkbox"/>	<input type="checkbox"/>	<input type="checkbox"/>	<input type="checkbox"/>	<input type="checkbox"/>	<input type="checkbox"/>	<input type="checkbox"/>	<input type="checkbox"/>	<input type="checkbox"/>	<input type="checkbox"/>	<input type="checkbox"/>	<input type="checkbox"/>	<input type="checkbox"/>	<input type="checkbox"/>	<input type="checkbox"/>
	ON	<input type="checkbox"/>	<input type="checkbox"/>	<input type="checkbox"/>	<input type="checkbox"/>	<input type="checkbox"/>	<input type="checkbox"/>	<input type="checkbox"/>	<input type="checkbox"/>	<input type="checkbox"/>	<input type="checkbox"/>	<input type="checkbox"/>	<input type="checkbox"/>	<input type="checkbox"/>	<input type="checkbox"/>	<input type="checkbox"/>

• Factory setting is "2".
 • Enable at ○
 • When low vibration is selected at 8~F, S.SEL setting is ignored and operate at low vibration mode of 1 division.

④ Connector (CN1)

Connect motor power wire.

⑤ Connector (CN2)

Connect DC power wire.

⑥ Connector (CN3)

Connect I/O wire.

PMM-BA-4803
PMM-BA-4804

PMM-UA-4303
PMM-UA-4304

PMM-MD-2316-10/2321-10
PMM-MD-2320-21/2321-21
PMM-MD-2320-10/2321-10

PMM-MD-2312D

Operation, Connection, and Function

● External wiring diagram

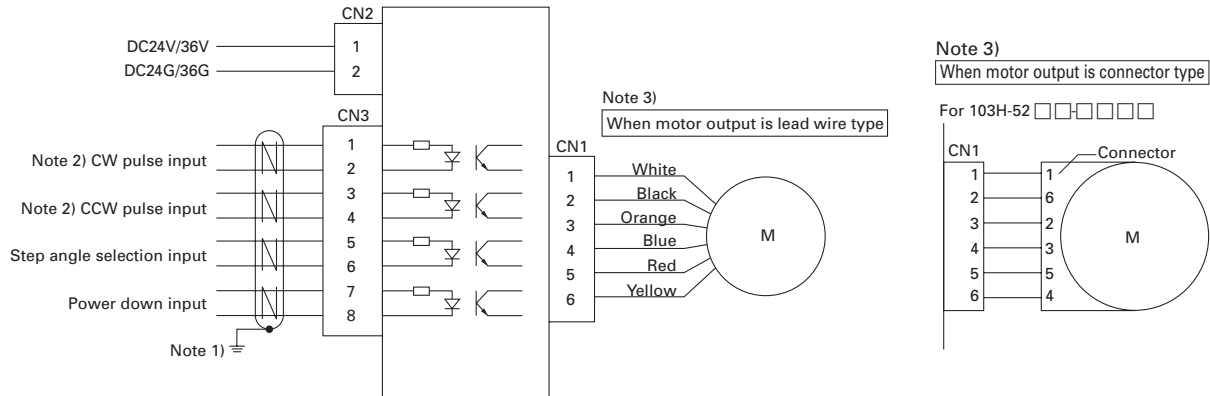

Note 1) Use twist pair shielded cables.

Note 2) Selection is possible between "2-input mode (CW pulse, CCW pulse)" and "Pulse and direction mode (CW, C/D)" by the mode selection rotary switch

Note 3) Motor output of stepping motor models 103H52 □□ is connector type. Motor side pin number and driver side connector (CN1) pin number is not match. So please be careful when connecting.

● Connectors used

Driver side		Corresponding connector model number	Maker
Use for	Model No.		
Stepping motor (CN1)	B6P-VH	Applicable housing: VHR-6N Applicable contact: BVH-21T-P1.1	J.S.T. MFG. CO., LTD
DC Power source (CN2)	B2P-VH	Applicable housing: VHR-2N Applicable contact: BVH-21T-P1.1	J.S.T. MFG. CO., LTD
I/O signal (CN3)	IL-8P-S3 EN2-1	Applicable housing: IL-8S-S3L-(N) Applicable contact: IL-C2-1-10000	Japan Aviation Electronics Industry, Ltd

- For the applicable connector, the client is requested to procure or place orders with us from the optional connector sets or the connector cables we offer (Refer to the page 55).

Dimensions [Unit:mm(inch)]

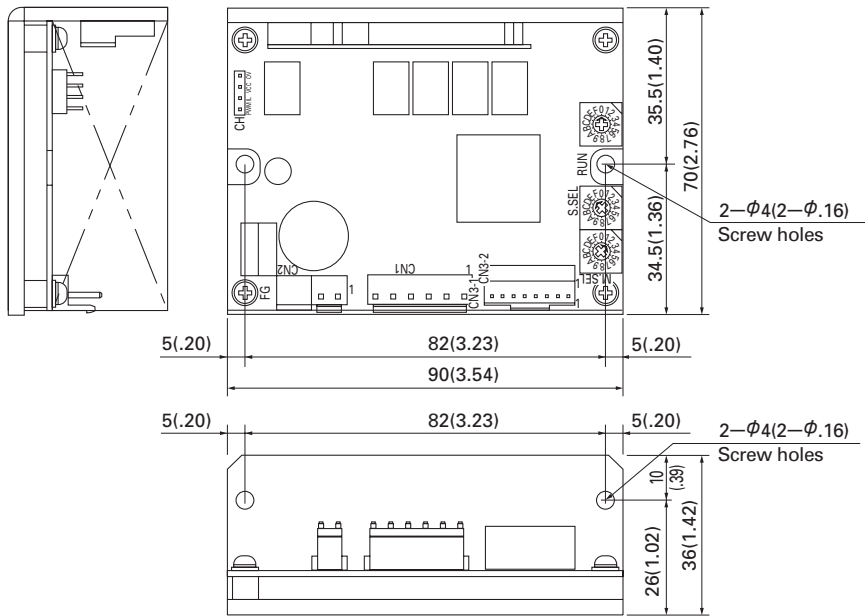

PMM-BA-4803
PMM-BA-4804
PMM-UA-4303
PMM-UA-4304
PMM-MD-2310-10/2321-10
PMM-MD-2320-21/2321-21
PMM-MD-2320-10/2321-10
PMM-MD-2312D

Mounting direction and mounting position

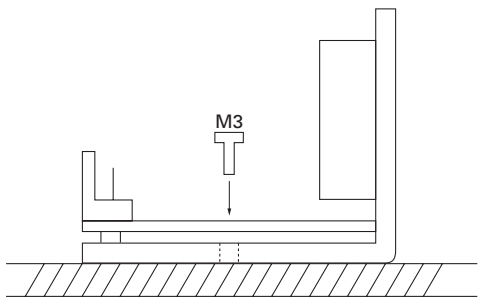

- Install the PM driver vertically.
- As shown in the figure, fix the PM driver by using the M3 screws through two fitting holes (2-φ 4) on the bottom surface of PM driver(no fitting metals are necessary).

Pulse Rate-Torque Characteristics/Pulse Rate-Power Current Characteristics

fs: No load maximum starting pulse rate. ■ 1-division is specified ■ 2-division is specified

● 103H5205-04 □□ : 24V

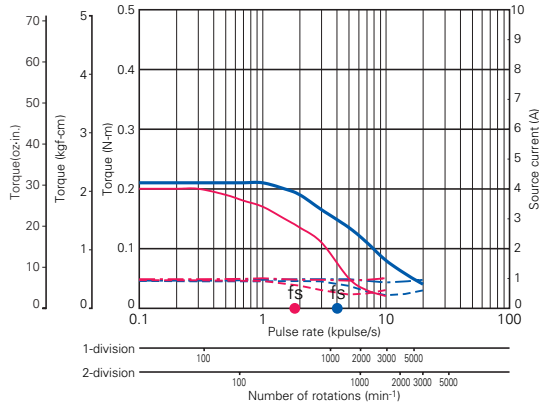

Source voltage: DC24V, Operating current :1.2A/phase
 — Pull-Out torque [$JL_1=0.94 \times 10^{-4} \text{kg-m}^2$ (5.14 oz-in²) Use the rubber coupling]
 - - - Source current (TL=MAX), - - - Source current (TL=0)

● 103H5205-04 □□ : 36V

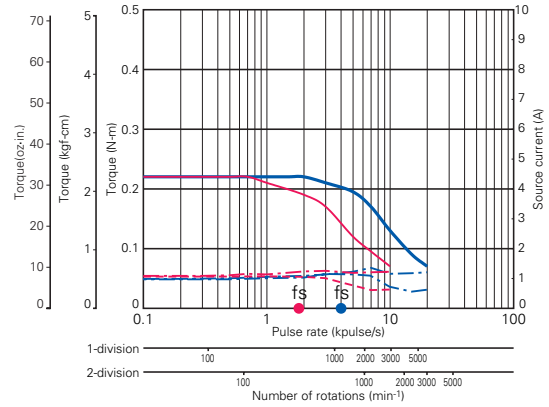

Source voltage: DC36V, Operating current :1.2A/phase
 — Pull-Out torque [$JL_1=0.94 \times 10^{-4} \text{kg-m}^2$ (5.14 oz-in²) Use the rubber coupling]
 - - - Source current (TL=MAX), - - - Source current (TL=0)

● 103H5208-04 □□ : 24V

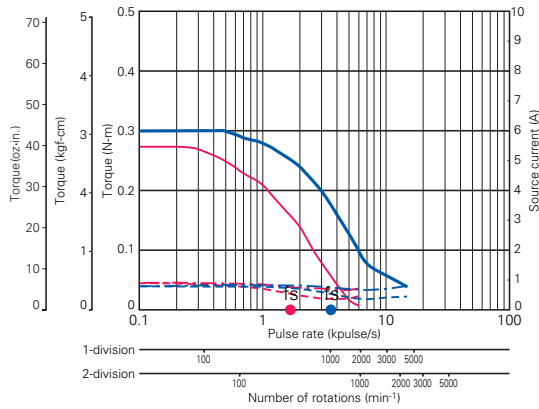

Source voltage: DC24V, Operating current :1.2A/phase
 — Pull-Out torque [$JL_1=0.94 \times 10^{-4} \text{kg-m}^2$ (5.14 oz-in²) Use the rubber coupling]
 - - - Source current (TL=MAX), - - - Source current (TL=0)

● 103H5208-04 □□ : 36V

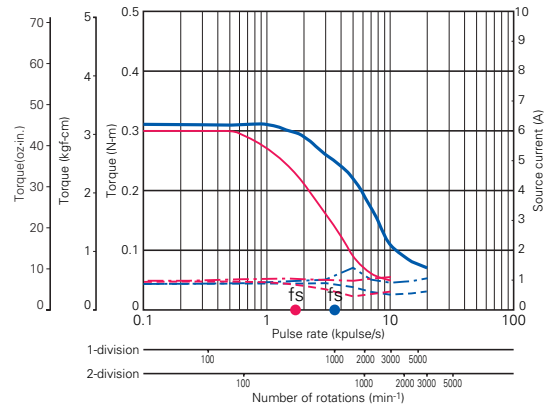

Source voltage: DC36V, Operating current :1.2A/phase
 — Pull-Out torque [$JL_1=0.94 \times 10^{-4} \text{kg-m}^2$ (5.14 oz-in²) Use the rubber coupling]
 - - - Source current (TL=MAX), - - - Source current (TL=0)

● 103H5209-04 □□ : 24V

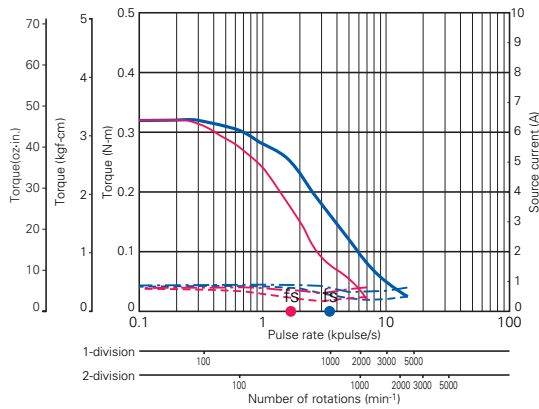

Source voltage: DC24V, Operating current :1.2A/phase
 — Pull-Out torque [$JL_1=0.94 \times 10^{-4} \text{kg-m}^2$ (5.14 oz-in²) Use the rubber coupling]
 - - - Source current (TL=MAX), - - - Source current (TL=0)

● 103H5209-04 □□ : 36V

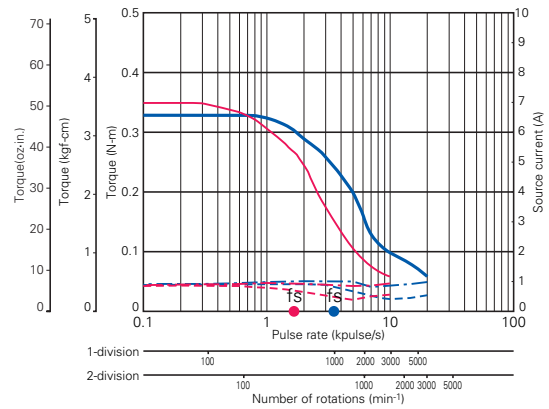

Source voltage: DC36V, Operating current :1.2A/phase
 — Pull-Out torque [$JL_1=0.94 \times 10^{-4} \text{kg-m}^2$ (5.14 oz-in²) Use the rubber coupling]
 - - - Source current (TL=MAX), - - - Source current (TL=0)

Pulse Rate-Torque Characteristics/Pulse Rate-Power Current Characteristics

fs: No load maximum starting pulse rate. ■ 1-division is specified ■ 2-division is specified

103H5210-04 □□ : 24V

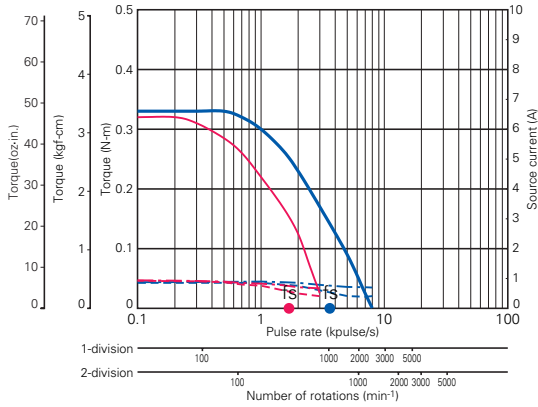

Source voltage: DC24V, Operating current : 1.2A/phase
 — Pull-Out torque [$J_{L1}=0.94 \times 10^{-4} \text{kg}\cdot\text{m}^2$ (5.14 oz-in²) Use the rubber coupling]
 - - - Source current (TL=MAX), - - - Source current (TL=0)

103H5210-04 □□ : 36V

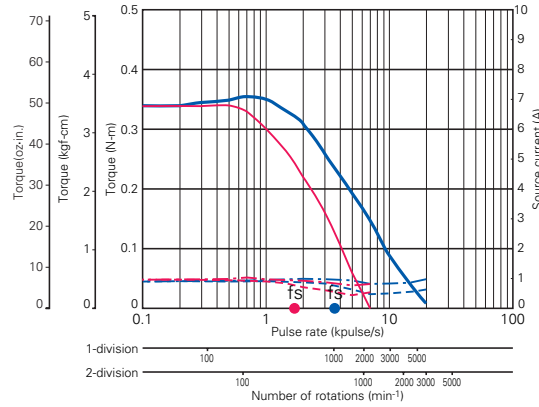

Source voltage: DC36V, Operating current : 1.2A/phase
 — Pull-Out torque [$J_{L1}=0.94 \times 10^{-4} \text{kg}\cdot\text{m}^2$ (5.14 oz-in²) Use the rubber coupling]
 - - - Source current (TL=MAX), - - - Source current (TL=0)

103H6701-04 □□ : 24V

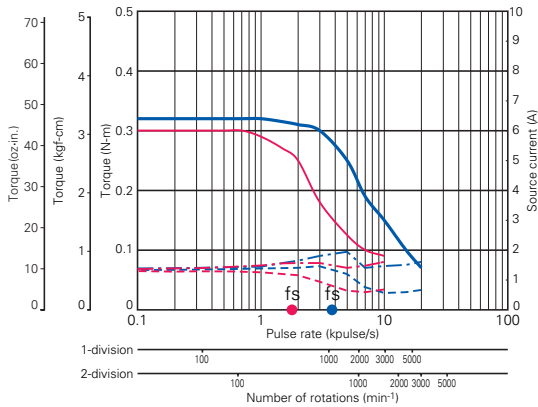

Source voltage: DC24V, Operating current : 2A/phase
 — Pull-Out torque [$J_{L1}=0.94 \times 10^{-4} \text{kg}\cdot\text{m}^2$ (5.14 oz-in²) Use the rubber coupling]
 - - - Source current (TL=MAX), - - - Source current (TL=0)

103H6701-04 □□ : 36V

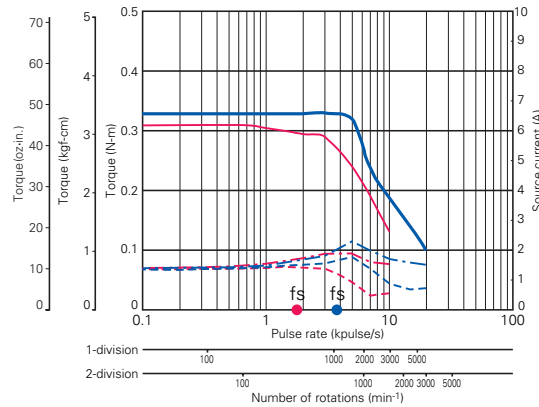

Source voltage: DC36V, Operating current : 2A/phase
 — Pull-Out torque [$J_{L1}=0.94 \times 10^{-4} \text{kg}\cdot\text{m}^2$ (5.14 oz-in²) Use the rubber coupling]
 - - - Source current (TL=MAX), - - - Source current (TL=0)

103H6703-04 □□ : 24V

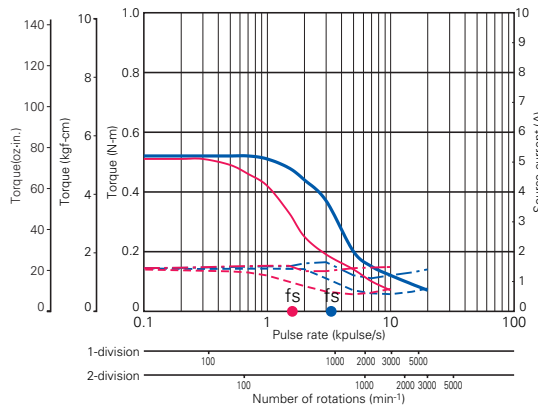

Source voltage: DC24V, Operating current : 2A/phase
 — Pull-Out torque [$J_{L1}=0.94 \times 10^{-4} \text{kg}\cdot\text{m}^2$ (5.14 oz-in²) Use the rubber coupling]
 - - - Source current (TL=MAX), - - - Source current (TL=0)

103H6703-04 □□ : 36V

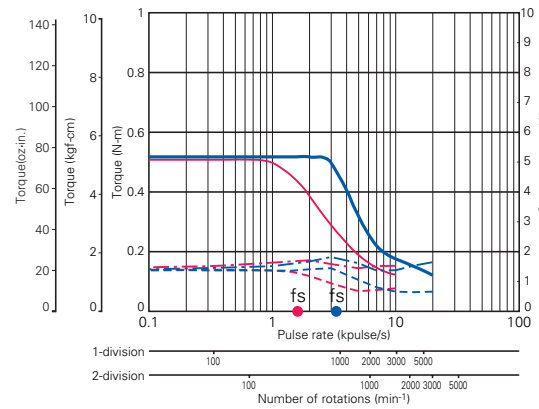

Source voltage: DC36V, Operating current : 2A/phase
 — Pull-Out torque [$J_{L1}=0.94 \times 10^{-4} \text{kg}\cdot\text{m}^2$ (5.14 oz-in²) Use the rubber coupling]
 - - - Source current (TL=MAX), - - - Source current (TL=0)

PMMA-BA-4803
 PMMA-BA-4804
 PMMA-UA-4303
 PMMA-UA-4304
 PMM-MD-2310-10/2321-10
 PMM-MD-2320-21/2321-21
 PMM-MD-2320-10/2321-10
 PMM-MD-2312D

Pulse Rate-Torque Characteristics/Pulse Rate-Power Current Characteristics

fs: No load maximum starting pulse rate. ■ 1-division is specified ■ 2-division is specified

● 103H6704-04 □ □ : 24V

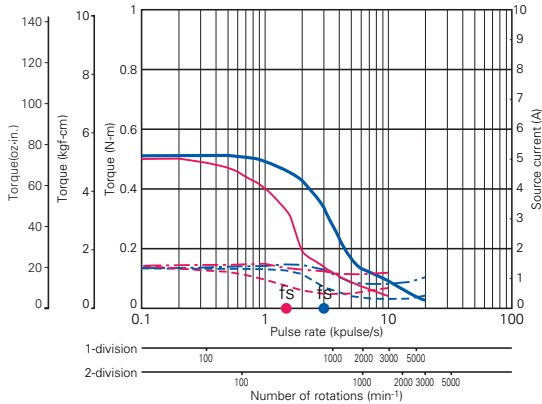

Source voltage: DC24V, Operating current : 2A/phase
 — Pull-Out torque [$JL_1=0.94 \times 10^{-4} \text{kg}\cdot\text{m}^2$ (5.14 oz-in²) Use the rubber coupling]
 - - - Source current (TL=MAX), - - - Source current (TL=0)

● 103H6704-04 □ □ : 36V

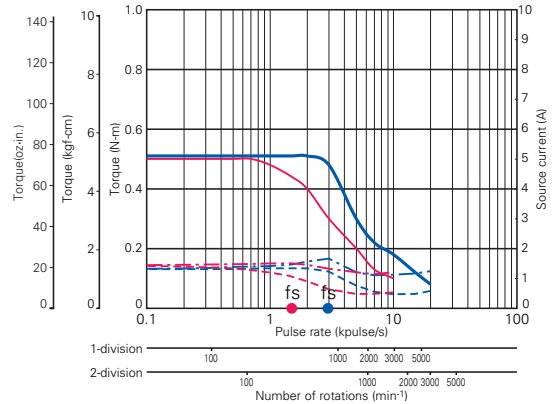

Source voltage: DC24V, Operating current : 2A/phase
 — Pull-Out torque [$JL_1=0.94 \times 10^{-4} \text{kg}\cdot\text{m}^2$ (5.14 oz-in²) Use the rubber coupling]
 - - - Source current (TL=MAX), - - - Source current (TL=0)

● 103H7121-04 □ □ : 24V

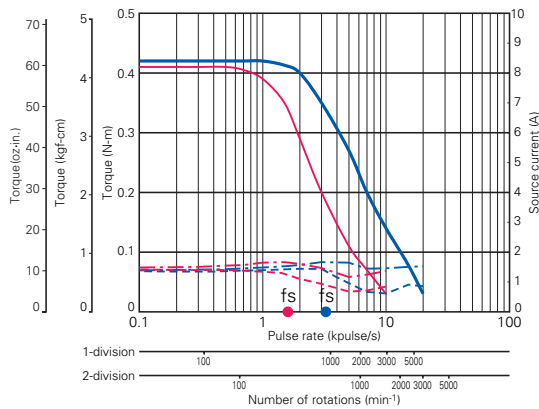

Source voltage: DC24V, Operating current : 2A/phase
 — Pull-Out torque [$JL_1=0.94 \times 10^{-4} \text{kg}\cdot\text{m}^2$ (5.14 oz-in²) Use the rubber coupling]
 - - - Source current (TL=MAX), - - - Source current (TL=0)

● 103H7121-04 □ □ : 36V

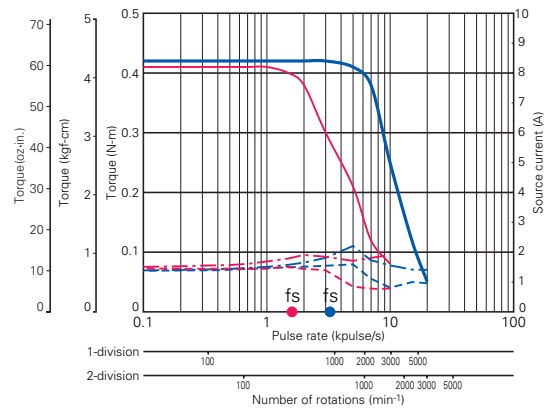

Source voltage: DC24V, Operating current : 2A/phase
 — Pull-Out torque [$JL_1=0.94 \times 10^{-4} \text{kg}\cdot\text{m}^2$ (5.14 oz-in²) Use the rubber coupling]
 - - - Source current (TL=MAX), - - - Source current (TL=0)

● 103H7123-04 □ □ : 24V

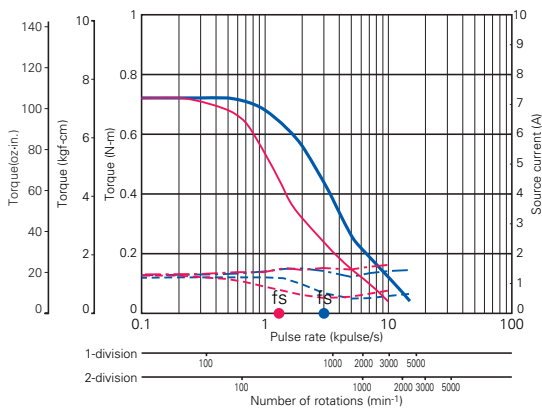

Source voltage: DC24V, Operating current : 2A/phase
 — Pull-Out torque [$JL_1=0.94 \times 10^{-4} \text{kg}\cdot\text{m}^2$ (5.14 oz-in²) Use the rubber coupling]
 - - - Source current (TL=MAX), - - - Source current (TL=0)

● 103H7123-04 □ □ : 36V

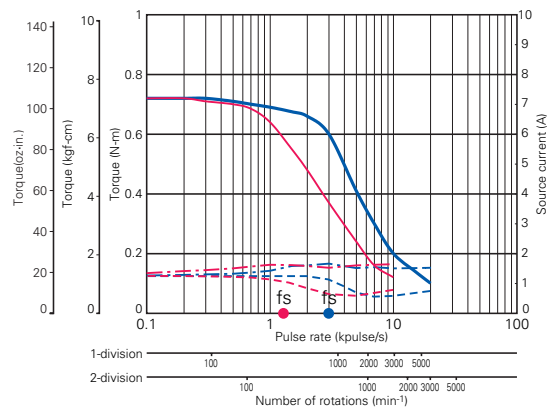

Source voltage: DC24V, Operating current : 2A/phase
 — Pull-Out torque [$JL_1=0.94 \times 10^{-4} \text{kg}\cdot\text{m}^2$ (5.14 oz-in²) Use the rubber coupling]
 - - - Source current (TL=MAX), - - - Source current (TL=0)

Pulse Rate-Torque Characteristics/Pulse Rate-Power Current Characteristics

fs:No load maximum starting pulse rate. ■ 1-division is specified ■ 2-division is specified

● 103H7124-04 □□ : 24V

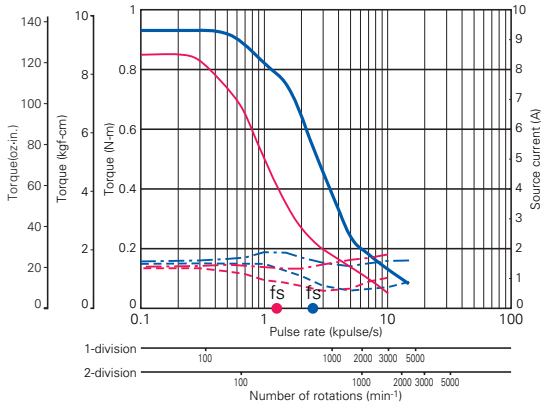

Source voltage: DC24V, Operating current : 2A/phase
 — Pull-Out torque [$J_{L1}=2.6 \times 10^{-4} \text{kg} \cdot \text{m}^2$ (14.22 oz-in²) Use the rubber coupling]
 - - - Source current (TL=MAX), - - - Source current (TL=0)

● 103H7124-04 □□ : 36V

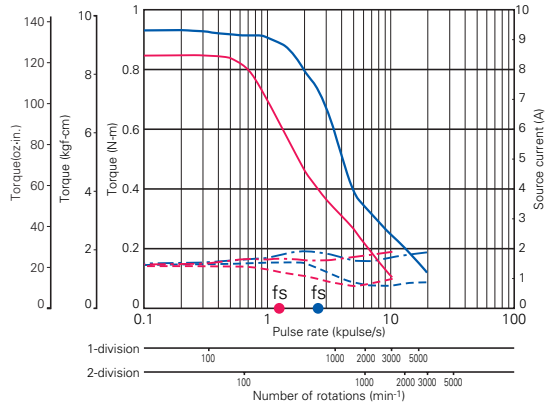

Source voltage: DC24V, Operating current : 2A/phase
 — Pull-Out torque [$J_{L1}=2.6 \times 10^{-4} \text{kg} \cdot \text{m}^2$ (14.22 oz-in²) Use the rubber coupling]
 - - - Source current (TL=MAX), - - - Source current (TL=0)

● 103H7126-04 □□ : 24V

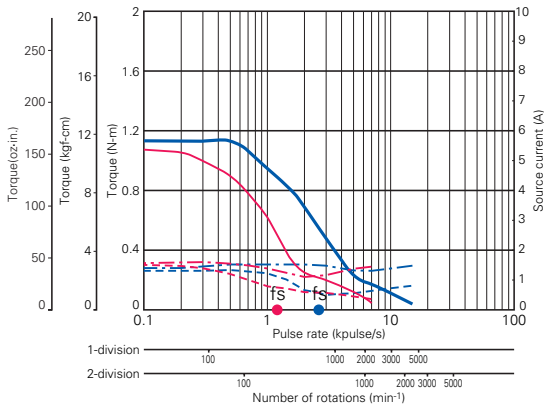

Source voltage: DC24V, Operating current : 2A/phase
 — Pull-Out torque [$J_{L1}=2.6 \times 10^{-4} \text{kg} \cdot \text{m}^2$ (14.22 oz-in²) Use the rubber coupling]
 - - - Source current (TL=MAX), - - - Source current (TL=0)

● 103H7126-04 □□ : 36V

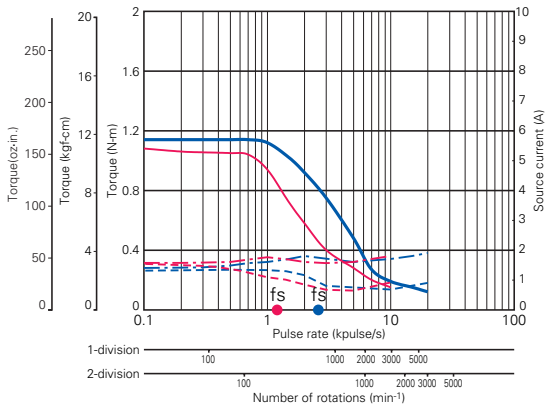

Source voltage: DC24V, Operating current : 2A/phase
 — Pull-Out torque [$J_{L1}=2.6 \times 10^{-4} \text{kg} \cdot \text{m}^2$ (14.22 oz-in²) Use the rubber coupling]
 - - - Source current (TL=MAX), - - - Source current (TL=0)

● 103H7821-04 □□ : 24V

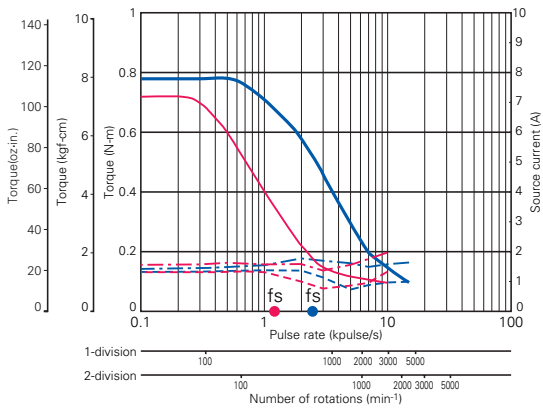

Source voltage: DC24V, Operating current : 2A/phase
 — Pull-Out torque [$J_{L1}=2.6 \times 10^{-4} \text{kg} \cdot \text{m}^2$ (14.22 oz-in²) Use the rubber coupling]
 - - - Source current (TL=MAX), - - - Source current (TL=0)

● 103H7821-04 □□ : 36V

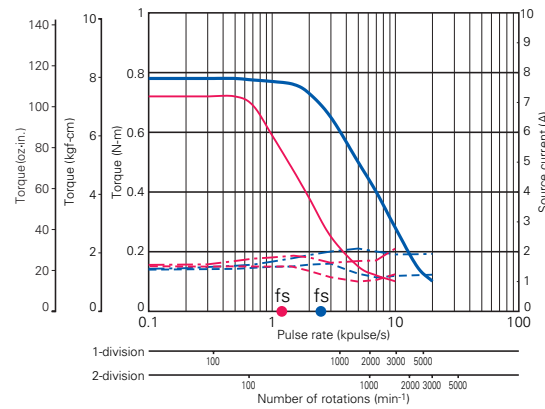

Source voltage: DC24V, Operating current : 2A/phase
 — Pull-Out torque [$J_{L1}=2.6 \times 10^{-4} \text{kg} \cdot \text{m}^2$ (14.22 oz-in²) Use the rubber coupling]
 - - - Source current (TL=MAX), - - - Source current (TL=0)

PMM-BA-4803
PMM-BA-4804

PMM-UA-4303
PMM-UA-4304

PMM-MD-3216-10/2321-10
PMM-MD-3220-21/2321-21
PMM-MD-3220-10/2321-10

PMM-MD-2312D

Pulse Rate-Torque Characteristics/Pulse Rate-Power Current Characteristics

fs: No load maximum starting pulse rate. ■ 1-division is specified ■ 2-division is specified

● 103H7822-04 □ □ : 24V

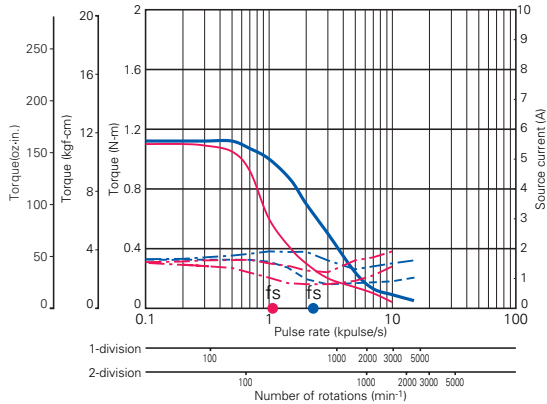

Source voltage: DC24V, Operating current : 2A/phase
 — Pull-Out torque [$JL_1=2.6 \times 10^{-4} \text{kg}\cdot\text{m}^2$ (14.22 oz-in²) Use the rubber coupling]
 - - - Source current (TL=MAX), - - - Source current (TL=0)

● 103H7822-04 □ □ : 36V

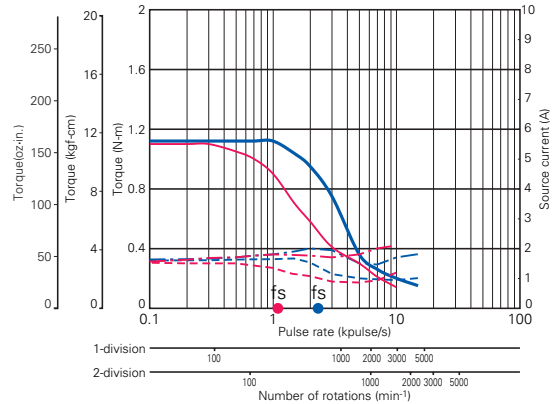

Source voltage: DC24V, Operating current : 2A/phase
 — Pull-Out torque [$JL_1=2.6 \times 10^{-4} \text{kg}\cdot\text{m}^2$ (14.22 oz-in²) Use the rubber coupling]
 - - - Source current (TL=MAX), - - - Source current (TL=0)

● 103H7823-04 □ □ : 24V

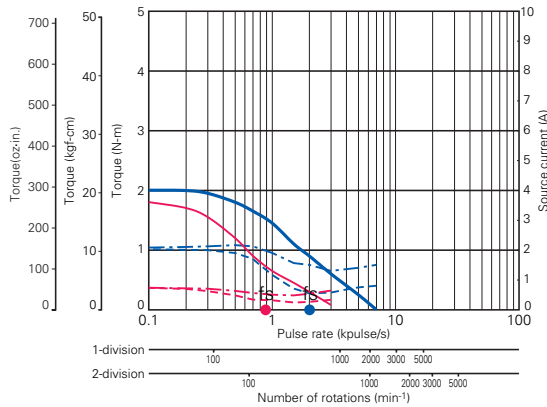

Source voltage: DC24V, Operating current : 2A/phase
 — Pull-Out torque [$JL_1=7.4 \times 10^{-4} \text{kg}\cdot\text{m}^2$ (40.46 oz-in²) Use the rubber coupling]
 - - - Source current (TL=MAX), - - - Source current (TL=0)

● 103H7823-04 □ □ : 36V

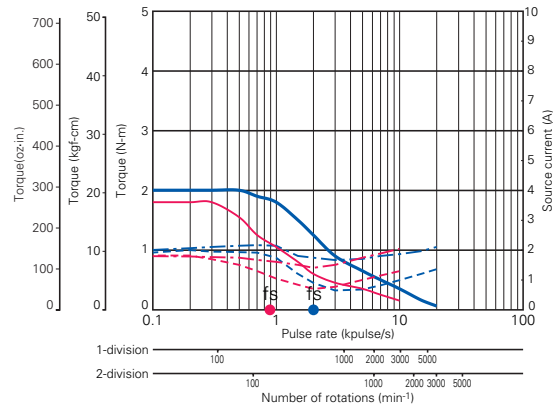

Source voltage: DC24V, Operating current : 2A/phase
 — Pull-Out torque [$JL_1=7.4 \times 10^{-4} \text{kg}\cdot\text{m}^2$ (40.46 oz-in²) Use the rubber coupling]
 - - - Source current (TL=MAX), - - - Source current (TL=0)

● 103H8221-04 □ □ : 24V

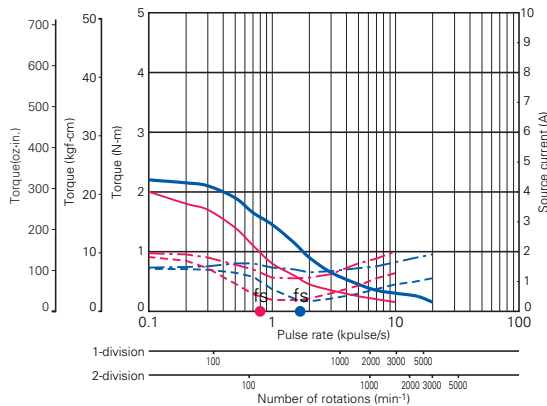

Source voltage: DC24V, Operating current : 2A/phase
 — Pull-Out torque [$JL_1=7.4 \times 10^{-4} \text{kg}\cdot\text{m}^2$ (40.46 oz-in²) Use the rubber coupling]
 - - - Source current (TL=MAX), - - - Source current (TL=0)

● 103H8221-04 □ □ : 36V

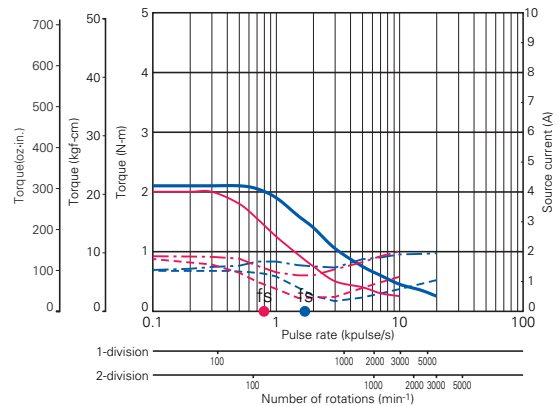

Source voltage: DC24V, Operating current : 2A/phase
 — Pull-Out torque [$JL_1=7.4 \times 10^{-4} \text{kg}\cdot\text{m}^2$ (40.46 oz-in²) Use the rubber coupling]
 - - - Source current (TL=MAX), - - - Source current (TL=0)

Pulse Rate-Torque Characteristics/Pulse Rate-Power Current Characteristics

fs: No load maximum starting pulse rate. ■ 1-division is specified ■ 2-division is specified

● 103H8222-04 □ □ : 24V

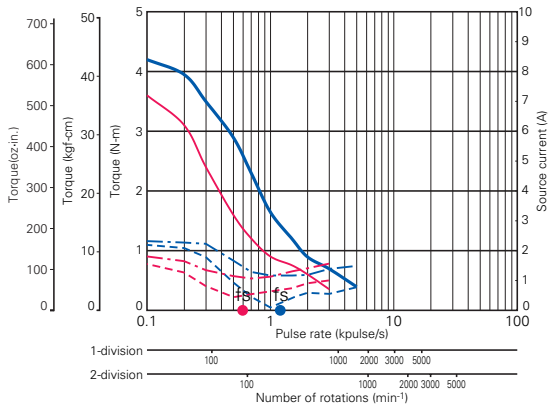

Source voltage: DC24V, Operating current : 2A/phase
 — Pull-Out torque [$J_{L1}=15.3 \times 10^{-4} \text{kg}\cdot\text{m}^2$ (83.65 oz-in²) Use the rubber coupling]
 - - - Source current (TL=MAX), - - - Source current (TL=0)

● 103H8222-04 □ □ : 36V

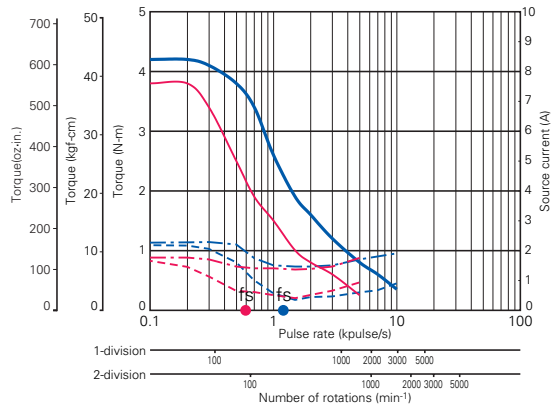

Source voltage: DC24V, Operating current : 2A/phase
 — Pull-Out torque [$J_{L1}=15.3 \times 10^{-4} \text{kg}\cdot\text{m}^2$ (83.65 oz-in²) Use the rubber coupling]
 - - - Source current (TL=MAX), - - - Source current (TL=0)

● 103H8223-04 □ □ : 24V

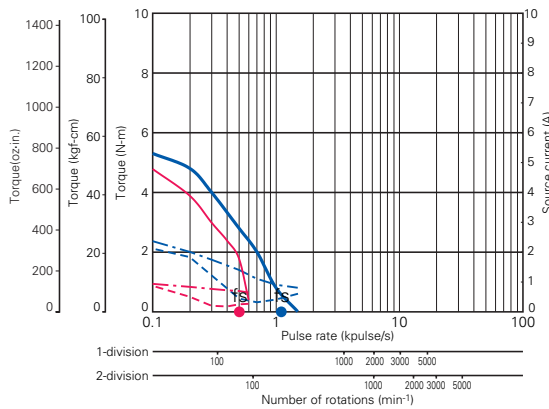

Source voltage: DC24V, Operating current : 2A/phase
 — Pull-Out torque [$J_{L1}=15.3 \times 10^{-4} \text{kg}\cdot\text{m}^2$ (83.65 oz-in²) Use the rubber coupling]
 - - - Source current (TL=MAX), - - - Source current (TL=0)

● 103H8223-04 □ □ : 36V

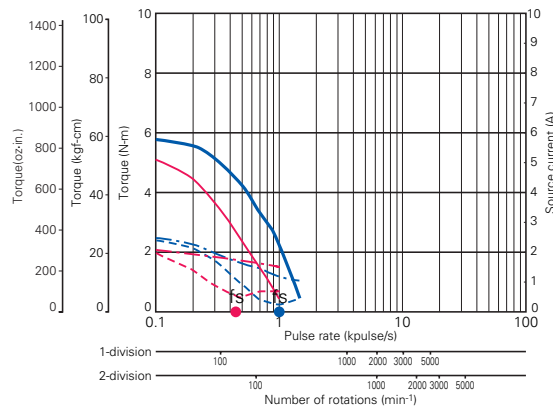

Source voltage: DC24V, Operating current : 2A/phase
 — Pull-Out torque [$J_{L1}=15.3 \times 10^{-4} \text{kg}\cdot\text{m}^2$ (83.65 oz-in²) Use the rubber coupling]
 - - - Source current (TL=MAX), - - - Source current (TL=0)

PMM-BA-4803
PMM-BA-4804

PMM-UA-4303
PMM-UA-4304

PMM-MD-2310-10/2321-10
PMM-MD-2320-21/2321-21
PMM-MD-2320-10/2321-10

PMM-MD-2312D

Option

● Connector set

Model	Used for	Contents of set	Quantity	Manufacturer	Applicable wire size	Crimp tool number
PM-AP-055 (H52 □□ type)	Stepping motor (CN1)	Applicable housing: VHR-6N	1	J.S.T. MFG. CO.,LTD.	AWG22	YC-160R
		Applicable contact: SVH-21T-P1.1	6			
		Applicable housing: EHR-6	1			YC-260R
		Applicable contact: SEH-001T-P0.6	6			
PM-AP-048 (H782 □□ type)		Applicable housing: VHR-6N	2	J.S.T. MFG. CO.,LTD.	AWG22	YC-160R
		Applicable contact: SVH-21T-P1.1	12			
PM-AP-037 (Type other than above)		Applicable housing: VHR-6N	1	J.S.T. MFG. CO.,LTD.	AWG22	YC-160R
		Applicable contact: SVH-21T-P1.1	6			
PM-AP-036	DC power supply (CN2)	Applicable housing: VHR-2N	1	J.S.T. MFG. CO.,LTD.	AWG22	YC-160R
		Applicable contact: SVH-21T-P1.1	2			
PM-AP-038	I/O signal (CN3)	Applicable housing: IL-8S-S3L-(N)	1	Japan Aviation Electronics Industry,Ltd	AWG22~28	CT150-1-IL CT150-1B-IL CT150-1C-IL
		Applicable contact: IL-C2-1-0001	8			

● Connector cable

Model No.	Use for
PM-C06M0100-□□	Stepping motor (CN1) connector cable
PM-C02P0100-03	DC power supply (CN2) connector cable
PM-C08S0100-02	I/O signal (CN3) connector cable

- The connector cable is 1-meter cable assembled with each interface connector.

□□... is 02, 04, or 07. (Refer to separate table 1.)

Model No. of stepping motor cable (Supplement table 1)

	Model of stepping motor
02	103H6701-04 □□
	103H6703-04 □□
	103H6704-04 □□
	103H7121-04 □□
	103H7123-04 □□
	103H7124-04 □□
	103H7126-04 □□
	103H8221-04 □□
	103H8222-04 □□
	103H8223-04 □□
04	103H7821-04 □□
	103H7822-04 □□
	103H7823-04 □□
07	103H5205-04 □□
	103H5208-04 □□
	103H5209-04 □□
	103H5210-04 □□

Option

● Cable 1 (Power cable)

Driver side	
Pin No.	Color
1	White
2	Black

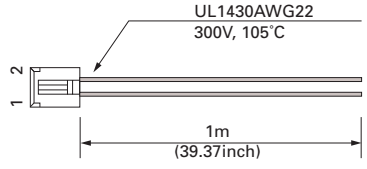

Cable model No.	Length
PM-C02P0100-03	1m(39.37inch)

● Cable 2 (Signal cable)

Driver side	
Pin No.	Color
1	Blue
2	Black
3	Blue
4	Black
5	Blue
6	Black
7	Blue
8	Black

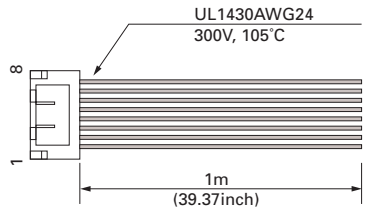

Cable model No.	Length
PM-C08S0100-02	1m(39.37inch)

● Cable 3 (Stepping motor extension cable 1)

Driver side	
Pin No.	Color
1	White
2	Black
3	Orange
4	Blue
5	Red
6	Yellow

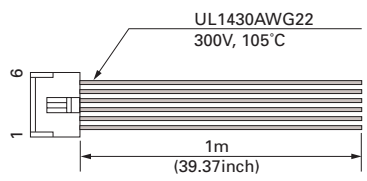

Cable model No.	Length
PM-C06M0100-02	1m(39.37inch)

Applicable stepping motor	
103H6701-04□0	103H7124-04□0
103H6703-04□0	103H7126-04□0
103H6704-04□0	103H8221-04□1
103H7121-04□0	103H8222-04□1
103H7123-04□0	103H8223-04□1

● Cable 4 (Stepping motor extension cable 2)

Driver side	
Pin No.	Color
1	White
2	Black
3	Orange
4	Blue
5	Red
6	Yellow

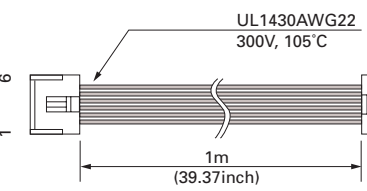

Stepping motor side	
Pin No.	Color
1	White
2	Orange
3	Blue
4	Red
5	Yellow
6	Black

Cable model No.	Length
PM-C06M0100-04	1m(39.37inch)

Applicable stepping motor	
103H7821-04□0	
103H7822-04□0	
103H7823-04□0	

● Cable 5 (Stepping motor extension cable 3)

Driver side	
Pin No.	Color
1	White
2	Black
3	Orange
4	Blue
5	Red
6	Yellow

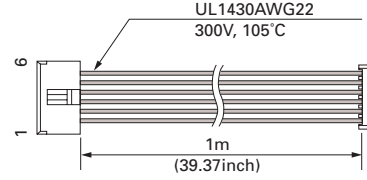

Stepping motor side	
Pin No.	Color
1	White
2	Orange
3	Blue
4	Yellow
5	Red
6	Black

Cable model No.	Length
PM-C06M0100-07	1m(39.37inch)

Applicable stepping motor	
103H5205-04□0	
103H5208-04□0	
103H5209-04□0	
103H5210-04□0	

PMM-BA-4803
 PMM-BA-4804
 PMM-UA-4303
 PMM-UA-4304
 PMM-MD-2310-10/2321-10
 PMM-MD-2320-21/2321-21
 PMM-MD-2320-10/2321-10
 PMM-MD-2312D

2 Phase

STEPPING MOTOR

The 2-phase Stepping System

Stepping System Configuration

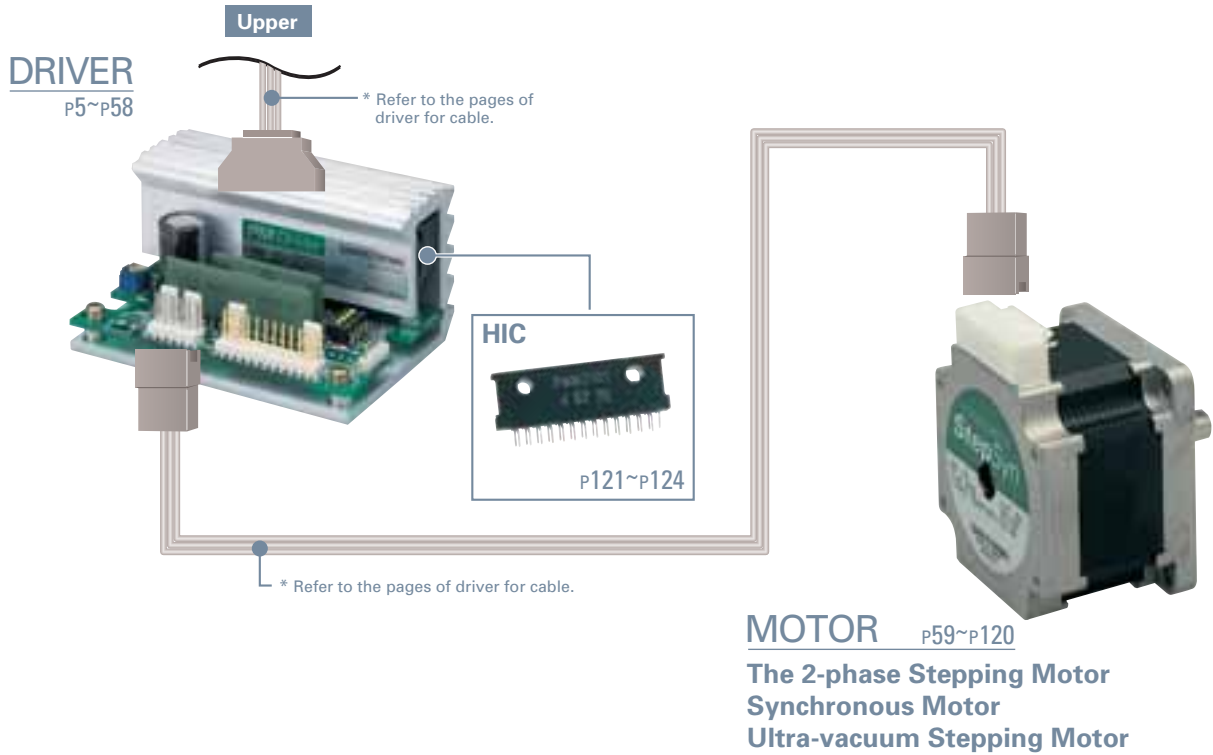

2-Phase Motor Domain Chart

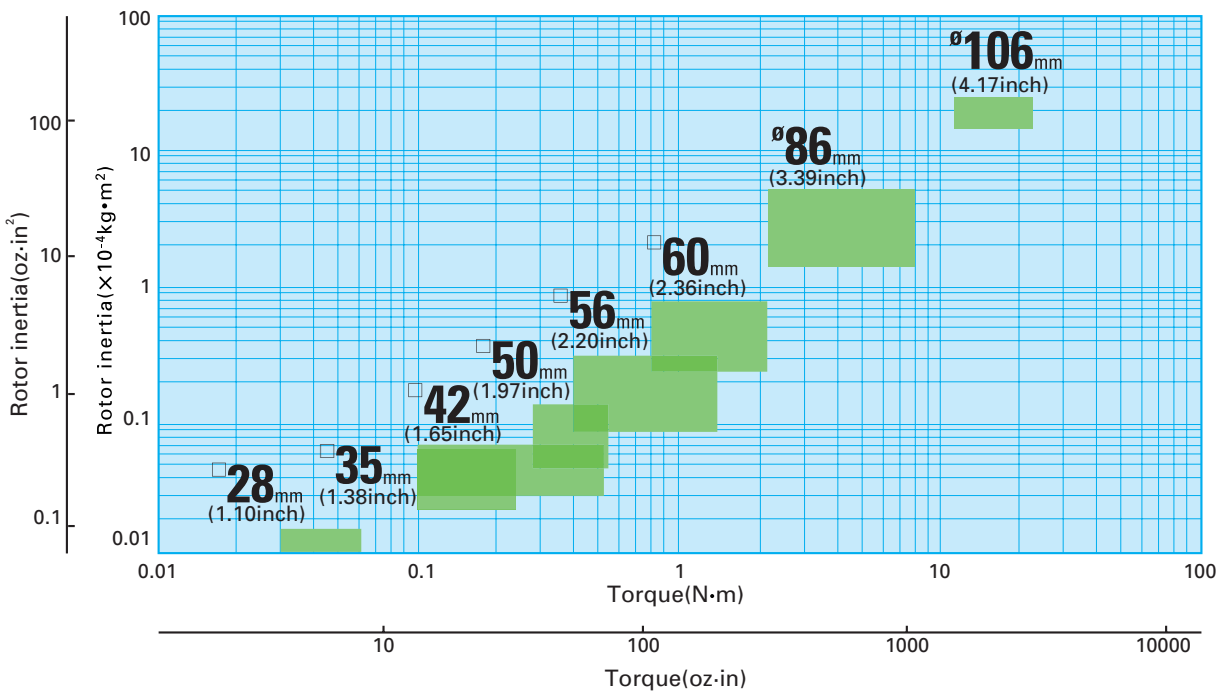

□35mm
(□1.38inch)



Step angle
1.8°
Holding torque
0.1~0.24N·m (14.16~33.99 oz-in) P61~P62

□39mm
(□1.54inch)



Step angle
0.9°
Holding torque
0.032N·m (4.53 oz-in) P63

□42mm
(□1.65inch)



Step angle
0.9°
Holding torque
0.1N·m (14.16 oz-in) P64

□28mm
(□1.10inch)



Step angle
1.8°
Holding torque
0.032~0.062N·m (4.53~8.78 oz-in) P65~P68

Recommendable
Refer to the page27.

□42mm
(□1.65inch)



Step angle
1.8°
Holding torque
0.2~0.51N·m (28.32~72.22 oz-in) P69~P74

Recommendable
Refer to the page7, 17,
27 and 43.

□50mm
(□1.97inch)



Step angle
1.8°
Holding torque
0.28~0.53N·m (39.6~75.1 oz-in) P75~P78

Recommendable
Refer to the page7, 17,
27 and 43.

□56mm
(□2.20inch)



Step angle
1.8°
Holding torque
0.39~1.27N·m (55.23~179.8 oz-in) P79~P86

Recommendable
Refer to the page7, 17,
27 and 43.

□60mm
(□2.36inch)



Step angle
1.8°
Holding torque
0.78~2.1N·m (110.5~297.4 oz-in) P87~P90

Recommendable
Refer to the page7, 17,
27 and 43.

∅86mm
(∅3.39inch)



Step angle
1.8°
Holding torque
2.15~7.44N·m (304.5~1053.6 oz-in) P91~P96

Recommendable
Refer to the page7, 17,
27 and 43.

∅106mm
(∅4.17inch)



Step angle
1.8°
Holding torque
10.8~19N·m (1529.4~2690.5 oz-in) P97~P98

Recommendable
Refer to the page7 and 17.

□56mm
(□2.20inch)



Step angle
1.8°
Holding torque
0.39~1.27N·m (55.23~179.8 oz-in) P99~P100

CE

∅86mm
(∅3.39inch)



Step angle
1.8°
Holding torque
2.74~7.44N·m (388.0~1053.6 oz-in) P101~P102

CE

∅106mm
(∅4.17inch)



Step angle
1.8°
Holding torque
13.2~19N·m (1869.2~2690.5 oz-in) P103~P104

CE

Synchronous motor



Getaway sync torque
0.57~5.5N·m (80.72~778.8 oz-in) P109~P110

Ultra-vacuum
Stepping Motor



Step angle
1.8°
Holding torque
0.42N·m (59.47 oz-in) P111~P112



2-phase Stepping Motor

35mm SH35
 (1.38inch sq.) 1.8°/step

Specifications

Unipolar winding

Model	Holding torque at 2-phase energization	Rated current	Resistance	Inductance	Rotor inertia	Mass(Weight)	
Shingle shaft	Double shafts	N-m(oz-in) MIN.	A/phase	Ω/phase	mH/phase	x10 ⁻⁴ kg-m ² (oz-in ²)	kg(lbs)
SH3533-12U40	-12U10	0.12(16.99)	1.2	2.4	1.3	0.02(1.09)	0.17(0.37)
SH3537-12U40	-12U10	0.15(21.24)	1.2	2.7	2	0.025(1.37)	0.2(0.44)
SH3552-12U40	-12U10	0.23(32.57)	1.2	3.4	2.8	0.043(2.35)	0.3(0.66)

Dimensions [Unit:mm(inch)]

SH3533-12U40(Single shaft) SH3533-12U10(Double shaft)

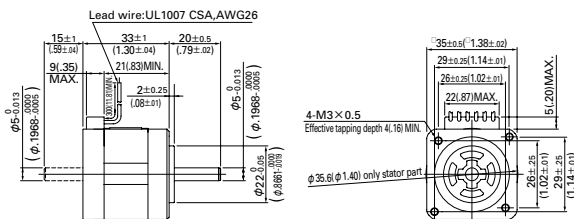

SH3537-12U40(Shingle shaft) SH3537-12U10(Double shaft)

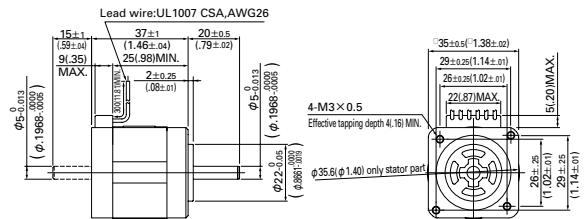

SH3552-12U40(Single shaft) SH3552-12U10(Double shaft)

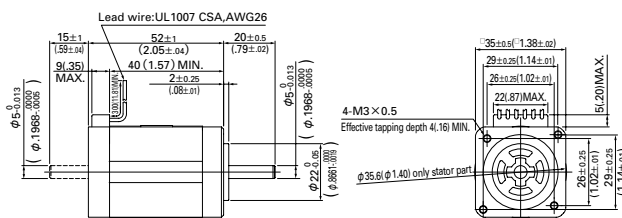

Pulse Rate - Torque Characteristics

● SH3533-12U40/SH3533-12U10

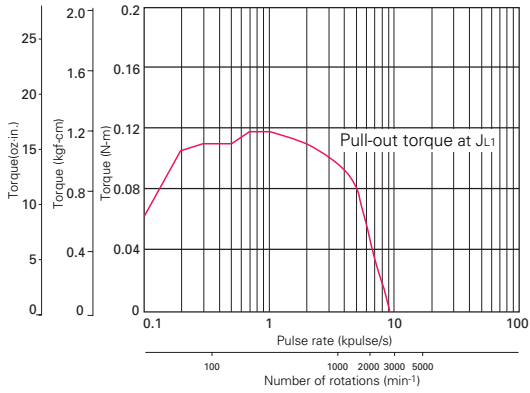

Sanyo constant current circuit
 Source voltage: DC24V
 Operating current : 1.2A/phase,2-phase energization (full-step)
 J_{L1}=[0.33 × 10⁻⁴kg · m² (1.80 oz-in²) Use the rubber coupling]

● SH3537-12U40/SH3537-12U10

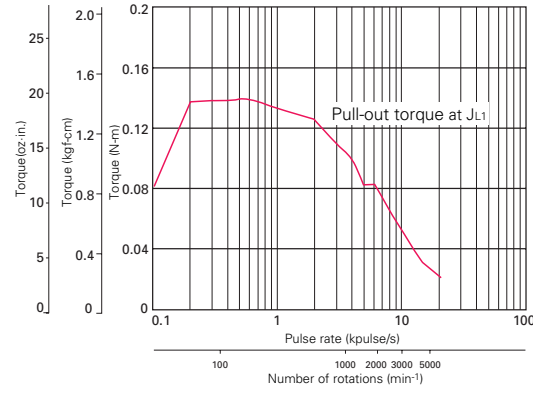

Sanyo constant current circuit
 Source voltage: DC24V
 Operating current : 1.2A/phase,2-phase energization (full-step)
 J_{L1}=[0.33 × 10⁻⁴kg · m² (1.80 oz-in²) Use the rubber coupling]

● SH3552-12U40/SH3552-12U10

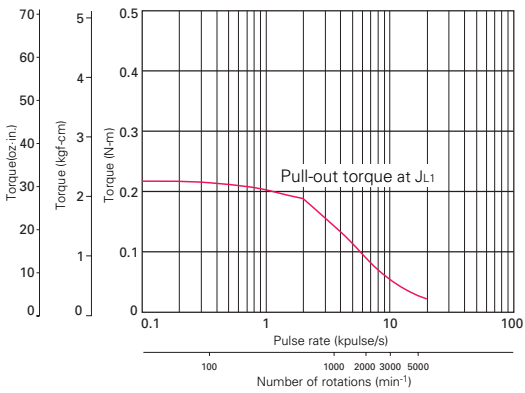

Sanyo constant current circuit
 Source voltage: DC24V
 Operating current : 1.2A/phase,2-phase energization (full-step)
 J_{L1}=[0.94 × 10⁻⁴kg · m² (5.14 oz-in²) Use the rubber coupling]

- 35mm(1.38)/1.8"
- 38mm(1.54)/0.9"
- 42mm(1.65)/0.9"
- 28mm(1.10)/1.8"
- 42mm(1.65)/1.8"
- 50mm(1.97)/1.8"
- 56mm(2.20)/1.8"
- 60mm(2.36)/1.8"
- 86mm(3.39)/1.8"
- 106mm(4.17)/1.8"
- 56mm(2.20)/CE
- 86mm(3.39)/CE
- 106mm(4.17)/CE
- In-vacuum stepping motor
- 2-phase synchronous motor



2-phase Stepping Motor

39mm sq. 103-4902
(1.54inch sq.) 0.9°/step

Specifications

Unipolar winding

Model		Holding torque at 2-phase energization	Rated current	Resistance	Inductance	Rotor inertia	Mass(Weight)
Single shaft	Double shaft	N·m(oz·in) MIN.	A/phase	Ω/phase	mH/phase	$\times 10^{-4}$ kg·m ² (oz·in ²)	kg(lbs)
103-4902-0650	-0610	0.032(4.53)	0.4	16.5	3.5	0.009(0.05)	0.135(0.30)

Dimensions [Unit:mm(inch)]

103-4902-0650 (Single shaft)
 103-4902-0610 (Double shaft)

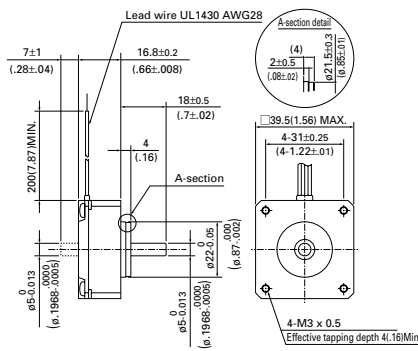

Pulse Rate - Torque Characteristics

● 103-4902-0650

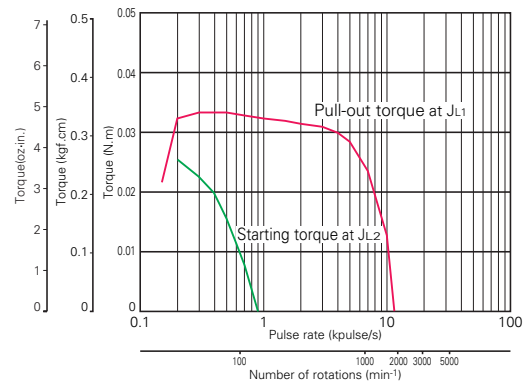

Sanyo constant current circuit

Source voltage: DC24V Operating current : 0.4A/phase, 2-phase energization (full-step)

J_{L1} =[0.05 $\times 10^{-4}$ kg·m² (0.27 oz·in²) pulley balancer method]

J_{L2} =[0.05 $\times 10^{-4}$ kg·m² (0.27 oz·in²) pulley balancer method]



2-phase Stepping Motor

42mm sq. (1.65inch sq.)
103-591 0.9°/step

Specifications

Unipolar winding

Model		Holding torque at 2-phase energization	Rated current	Resistance	Inductance	Rotor inertia	Mass(Weight)
Single shaft	Double shaft	N·m(oz·in) MIN.	A/phase	Ω/phase	mH/phase	$\times 10^{-4}$ kg·m ² (oz·in ²)	kg(lbs)
103-591-0241	-0210	0.1(14.16)	0.85	3.3	3.7	0.03(0.16)	0.2(0.44)

Dimensions [Unit:mm(inch)]

103-591-0241 (Single shaft)
103-591-0210 (Double shaft)

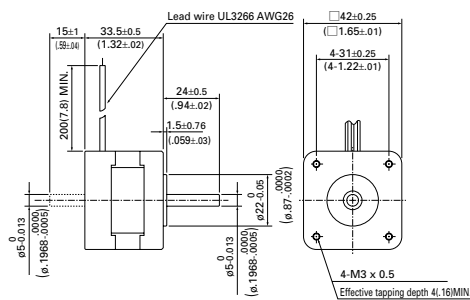

Pulse Rate - Torque Characteristics

● 103-591-0241

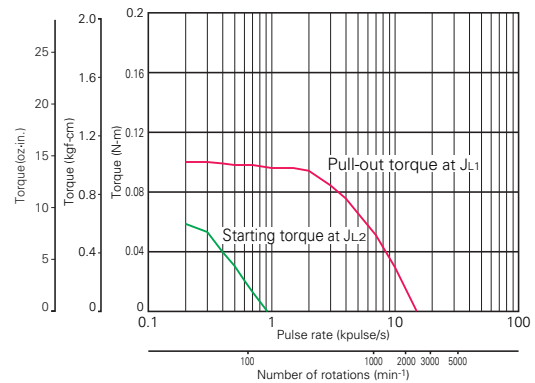

Sanyo constant current circuit

Source voltage: DC24V Operating current: 0.85A/phase, 2-phase energization (full-step)

J.L1=[0.33x10⁻⁴kg·m² (1.80 oz·in²) Uses rubber coupling]

J.L2=[0.18x10⁻⁴kg·m² (0.98 oz·in²) Use the direct coupling]

35mm(1.38)/1.8
39mm(1.54)/0.9
42mm(1.65)/0.9
28mm(1.10)/1.8
42mm(1.65)/1.8
50mm(1.97)/1.8
56mm(2.20)/1.8
60mm(2.36)/1.8
86mm(3.39)/1.8
106mm(4.17)/1.8
56mm(2.20)/CE
86mm(3.39)/CE
106mm(4.17)/CE

Specifications of 2-phase stepping motor
In-vacuum stepping motor
2-phase synchronous motor

2-phase Stepping Motor

28mm sq.
(1.10inch sq.)

103H32□□

1.8°/step

Recommendable Driver
Refer to the page 27.



Specifications

Unipolar winding · connector type

Model		Holding torque at 2-phase energization	Rated current	Resistance	Inductance	Rotor inertia	Mass(Weight)
Single shaft	Double shafts	N·m(oz·in) MIN.	A/phase	Ω/phase	mH/phase	$\times 10^{-4}$ kg·m ² (oz·in ²)	kg(lbs)
103H3205-5040	-5010	0.032(4.53)	0.25	40	9.1	0.009(0.05)	0.11(0.24)
103H3205-5140	-5110	0.032(4.53)	0.5	9.4	2.4	0.009(0.05)	0.11(0.24)
103H3215-5140	-5110	0.062(8.78)	0.5	11	3.1	0.016(0.09)	0.2(0.44)
103H3215-5240	-5210	0.062(8.78)	1	2.6	0.8	0.016(0.09)	0.2(0.44)

Unipolar winding · lead wire type

Model		Holding torque at 2-phase energization	Rated current	Resistance	Inductance	Rotor inertia	Mass(Weight)
Single shaft	Double shafts	N·m(oz·in) MIN.	A/phase	Ω/phase	mH/phase	$\times 10^{-4}$ kg·m ² (oz·in ²)	kg(lbs)
103H3205-5070	-5030	0.032(4.53)	0.25	40	9.1	0.009(0.05)	0.11(0.24)
103H3205-5170	-5130	0.032(4.53)	0.5	9.4	2.4	0.009(0.05)	0.11(0.24)
103H3215-5170	-5130	0.062(8.78)	0.5	11	3.1	0.016(0.09)	0.2(0.44)
103H3215-5270	-5230	0.062(8.78)	1	2.6	0.8	0.016(0.09)	0.2(0.44)

Bipolar winding · lead wire type

Model		Holding torque at 2-phase energization	Rated current	Resistance	Inductance	Rotor inertia	Mass(Weight)
Single shaft	Double shafts	N·m(oz·in) MIN.	A/phase	Ω/phase	mH/phase	$\times 10^{-4}$ kg·m ² (oz·in ²)	kg(lbs)
103H3205-5570	-5530	0.048(6.80)	0.25	38.3	19.5	0.009(0.05)	0.11(0.24)
103H3205-5670	-5630	0.051(7.22)	0.5	10.4	6.2	0.009(0.05)	0.11(0.24)
103H3205-5770	-5730	0.051(7.22)	1	2.5	1.6	0.009(0.05)	0.11(0.24)
103H3215-5570	-5530	0.09(12.74)	0.25	51.8	30.7	0.016(0.09)	0.2(0.44)
103H3215-5670	-5630	0.09(12.74)	0.5	12.5	8	0.016(0.09)	0.2(0.44)
103H3215-5770	-5730	0.1(14.16)	1	3.5	2.3	0.016(0.09)	0.2(0.44)

Dimensions [Unit:mm(inch)]

103H3205-5040/5140 (Single shaft)
103H3205-5010/5110 (Double shaft)

Applicable connector : JST Mfg.Co.,Ltd
Connector : PHR-6
Terminal : SPH-002T-P0.5S

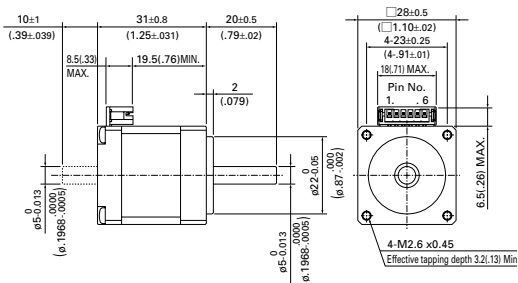

103H3215-5140/5240 (Single shaft)
103H3215-5110/5210 (Double shaft)

Applicable connector : JST Mfg.Co.,Ltd
Connector : PHR-6
Terminal : SPH-002T-P0.5S

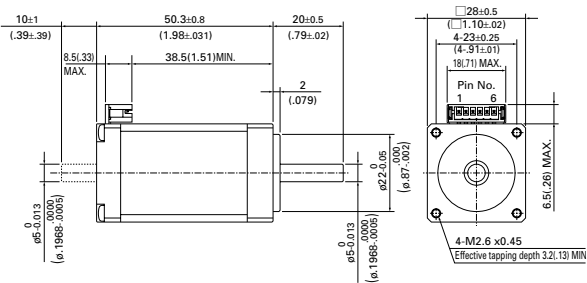

103H3205-5070/5170 (Single shaft)
103H3205-5030/5130 (Double shaft)

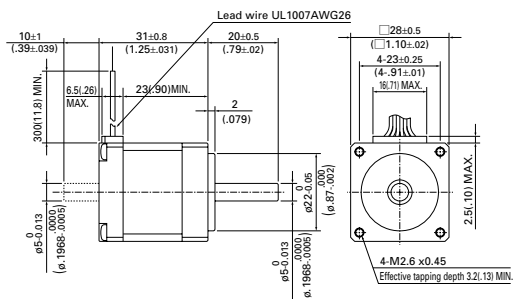

103H3215-5170/5270 (Single shaft)
103H3215-5130/5230 (Double shaft)

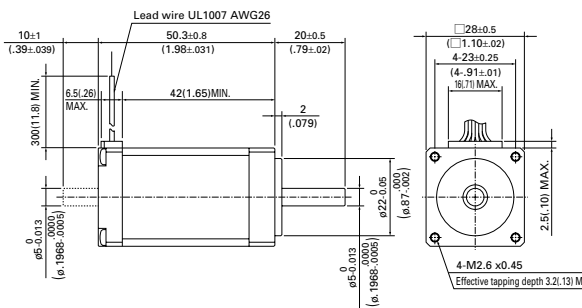

Bipolar winding

103H3205-5570/5670/5770 (Single shaft)
103H3205-5530/5630/5730 (Double shaft)

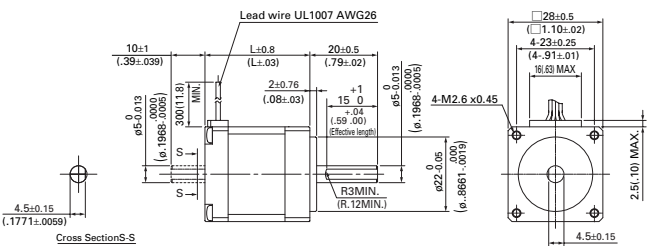

Model	L
103H3205-55□	31
103H3205-56□	(1.22)
103H3205-57□	
103H3215-55□	50.3
103H3215-56□	(1.98)
103H3215-57□	

35mm(1.38)/1.8"
 39mm(1.54)/0.9"
 42mm(1.65)/0.9"
 28mm(1.10)/1.8"
 42mm(1.65)/1.8"
 42mm(1.65)/1.8"
 50mm(1.97)/1.8"
 56mm(2.20)/1.8"
 60mm(2.36)/1.8"
 68mm(3.39)/1.8"
 106mm(4.17)/1.8"
 106mm(3.39)/CE
 56mm(2.20)/CE
 106mm(4.17)/CE
 106mm(4.17)/CE
 Specifications of 2-phase stepping motor
 In-vacuum stepping motor
 2-phase synchronous motor

Pulse Rate - Torque Characteristics

● 103H3205-5040/103H3205-5070

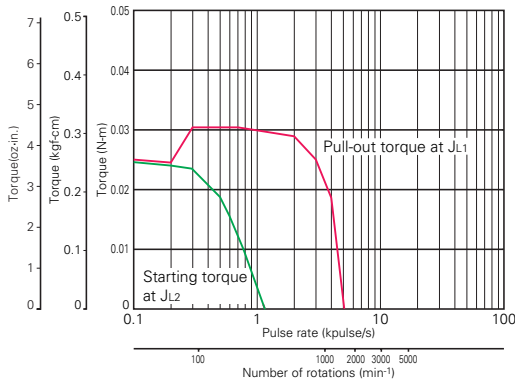

Sanyo constant current circuit
 Source voltage: DC24V Operating current: 0.25A/phase, 2-phase energization (full-step)
 $J_{L1}=[0.01 \times 10^{-4} \text{kg} \cdot \text{m}^2 (0.05 \text{oz} \cdot \text{in}^2)$ pulley balancer method
 $J_{L2}=[0.01 \times 10^{-4} \text{kg} \cdot \text{m}^2 (0.05 \text{oz} \cdot \text{in}^2)$ pulley balancer method

● 103H3205-5140/103H3205-5170

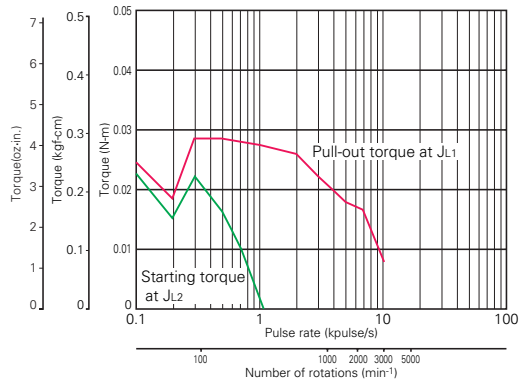

Sanyo constant current circuit
 Source voltage: DC24V Operating current: 0.5A/phase, 2-phase energization (full-step)
 $J_{L1}=[0.01 \times 10^{-4} \text{kg} \cdot \text{m}^2 (0.05 \text{oz} \cdot \text{in}^2)$ pulley balancer method
 $J_{L2}=[0.01 \times 10^{-4} \text{kg} \cdot \text{m}^2 (0.05 \text{oz} \cdot \text{in}^2)$ pulley balancer method

● 103H3215-5140/103H3215-5170

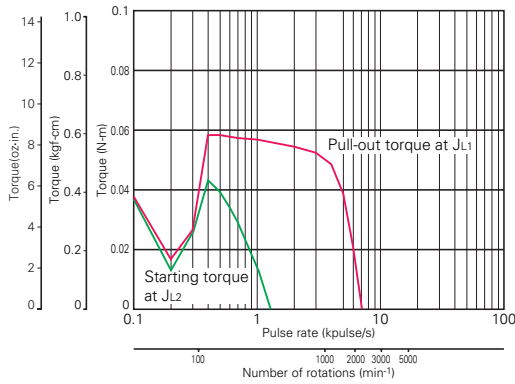

Sanyo constant current circuit
 Source voltage: DC24V Operating current: 0.5A/phase, 2-phase energization (full-step)
 $J_{L1}=[0.01 \times 10^{-4} \text{kg} \cdot \text{m}^2 (0.05 \text{oz} \cdot \text{in}^2)$ pulley balancer method
 $J_{L2}=[0.01 \times 10^{-4} \text{kg} \cdot \text{m}^2 (0.05 \text{oz} \cdot \text{in}^2)$ pulley balancer method

● 103H3215-5240/103H3215-5270

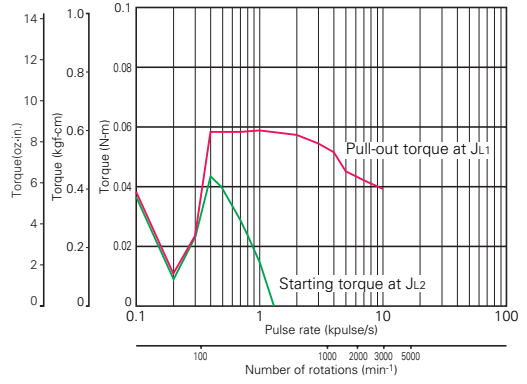

Sanyo constant current circuit
 Source voltage: DC24V Operating current: 1A/phase, 2-phase energization (full-step)
 $J_{L1}=[0.01 \times 10^{-4} \text{kg} \cdot \text{m}^2 (0.05 \text{oz} \cdot \text{in}^2)$ pulley balancer method
 $J_{L2}=[0.01 \times 10^{-4} \text{kg} \cdot \text{m}^2 (0.05 \text{oz} \cdot \text{in}^2)$ pulley balancer method

● 103H3205-5570

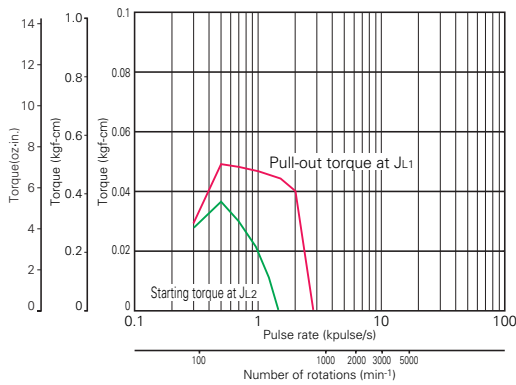

Sanyo constant current circuit
 Source voltage: DC24V Operating current: 0.25A/phase, 2-phase energization (full-step)
 $J_{L1}=[0.01 \times 10^{-4} \text{kg} \cdot \text{m}^2 (0.05 \text{oz} \cdot \text{in}^2)$ pulley balancer method
 $J_{L2}=[0.01 \times 10^{-4} \text{kg} \cdot \text{m}^2 (0.05 \text{oz} \cdot \text{in}^2)$ pulley balancer method

● 103H3205-5670

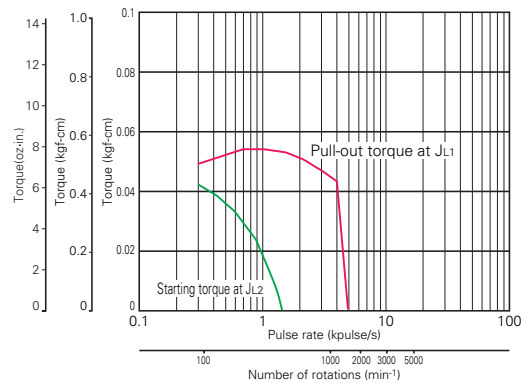

Sanyo constant current circuit
 Source voltage: DC24V Operating current: 0.5A/phase, 2-phase energization (full-step)
 $J_{L1}=[0.01 \times 10^{-4} \text{kg} \cdot \text{m}^2 (0.05 \text{oz} \cdot \text{in}^2)$ pulley balancer method
 $J_{L2}=[0.01 \times 10^{-4} \text{kg} \cdot \text{m}^2 (0.05 \text{oz} \cdot \text{in}^2)$ pulley balancer method

Pulse Rate - Torque Characteristics

● 103H3205-5770

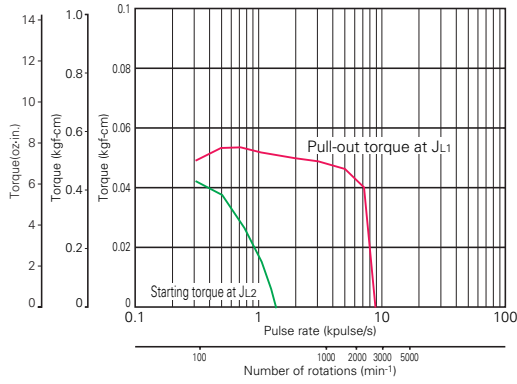

Sanyo constant current circuit
 Source voltage: DC24V Operating current: 1A/phase, 2-phase energization (full-step)
 $J_{L1}=[0.01 \times 10^{-4} \text{kg} \cdot \text{m}^2 \text{ (0.05 oz-in}^2\text{) pulley balancer method}]$
 $J_{L2}=[0.01 \times 10^{-4} \text{kg} \cdot \text{m}^2 \text{ (0.05 oz-in}^2\text{) pulley balancer method}]$

● 103H3215-5570

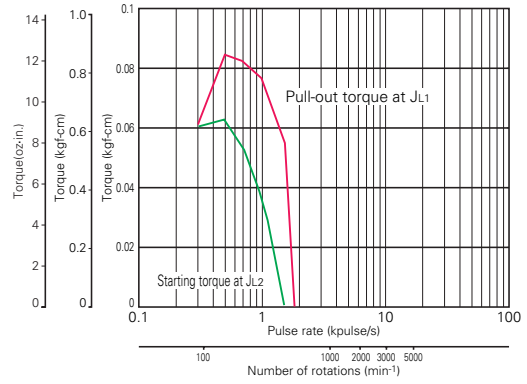

Sanyo constant current circuit
 Source voltage: DC24V Operating current: 0.25A/phase, 2-phase energization (full-step)
 $J_{L1}=[0.01 \times 10^{-4} \text{kg} \cdot \text{m}^2 \text{ (0.05 oz-in}^2\text{) pulley balancer method}]$
 $J_{L2}=[0.01 \times 10^{-4} \text{kg} \cdot \text{m}^2 \text{ (0.05 oz-in}^2\text{) pulley balancer method}]$

● 103H3215-5670

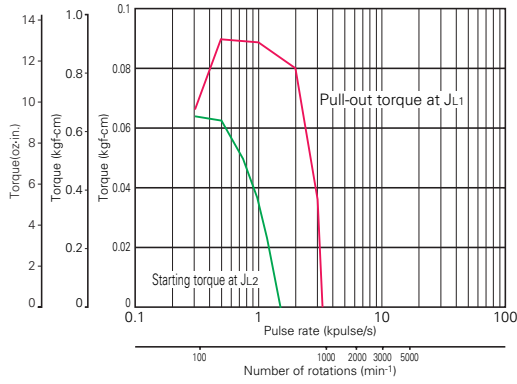

Sanyo constant current circuit
 Source voltage: DC24V Operating current: 0.5A/phase, 2-phase energization (full-step)
 $J_{L1}=[0.01 \times 10^{-4} \text{kg} \cdot \text{m}^2 \text{ (0.05 oz-in}^2\text{) pulley balancer method}]$
 $J_{L2}=[0.01 \times 10^{-4} \text{kg} \cdot \text{m}^2 \text{ (0.05 oz-in}^2\text{) pulley balancer method}]$

● 103H3215-5770

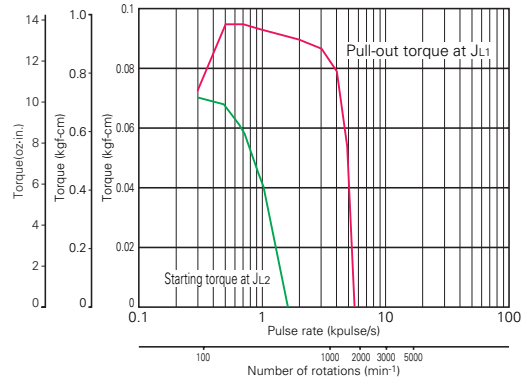

Sanyo constant current circuit
 Source voltage: DC24V Operating current: 1A/phase, 2-phase energization (full-step)
 $J_{L1}=[0.01 \times 10^{-4} \text{kg} \cdot \text{m}^2 \text{ (0.05 oz-in}^2\text{) pulley balancer method}]$
 $J_{L2}=[0.01 \times 10^{-4} \text{kg} \cdot \text{m}^2 \text{ (0.05 oz-in}^2\text{) pulley balancer method}]$

- 35mm(1.38)/1.8"
- 39mm(1.54)/0.9"
- 42mm(1.65)/0.9"
- 28mm(1.10)/1.8"
- 42mm(1.65)/1.8"
- 50mm(1.97)/1.8"
- 56mm(2.20)/1.8"
- 60mm(2.36)/1.8"
- 68mm(3.39)/1.8"
- 86mm(4.17)/1.8"
- 106mm(4.17)/1.8"
- 56mm(2.20)/CE
- 68mm(3.39)/CE
- 86mm(4.17)/CE
- 106mm(4.17)/CE
- Specifications of 2-phase stepping motor
- In-vacuum stepping motor
- 2-phase synchronous motor



2-phase Stepping Motor

42mm sq. 103H52 □□
(1.65inch sq.) 1.8°/step

Recommendable Driver
 Refer to the page 7,17,27 and 45.

Specifications

Unipolar winding

Model		Holding torque at 2-phase energization N·m (oz·in)/MIN.	Rated current A/phase	Resistance Ω/phase	Inductance mH/phase	Rotor inertia x10 ⁻⁴ kg·m ² (oz·in ²)	Mass(Weight) kg(lbs)
Single shaft	Double shaft						
103H5205-0440	-0410	0.2(28.32)	1.2	2.4	2.3	0.036(0.20)	0.23(0.51)
103H5208-0440	-0410	0.3(42.48)	1.2	2.9	3.4	0.056(0.31)	0.29(0.64)
103H5209-0440	-0410	0.32(45.31)	1.2	3	3.9	0.062(0.34)	0.31(0.68)
103H5210-0440	-0410	0.37(52.39)	1.2	3.3	3.4	0.074(0.40)	0.37(0.82)

Bipolar winding

Model		Holding torque at 2-phase energization N·m (oz·in)/MIN.	Rated current A/phase	Resistance Ω/phase	Inductance mH/phase	Rotor inertia x10 ⁻⁴ kg·m ² (oz·in ²)	Mass(Weight) kg(lbs)
Single shaft	Double shaft						
103H5205-4240	-4210	0.265(37.53)	1	3.4	6.5	0.036(0.20)	0.23(0.51)
103H5205-5040	-5010	0.23(32.57)	0.25	54	78	0.036(0.20)	0.23(0.51)
103H5205-5140	-5110	0.25(35.40)	0.5	13.4	23.4	0.036(0.20)	0.23(0.51)
103H5205-5240	-5210	0.265(37.53)	1	3.4	6.5	0.036(0.20)	0.23(0.51)
103H5208-4240	-4210	0.39(55.23)	1	4.1	9.5	0.056(0.31)	0.3(0.66)
103H5208-5040	-5010	0.35(49.56)	0.25	66	116	0.056(0.31)	0.3(0.66)
103H5208-5140	-5110	0.38(53.81)	0.5	16.5	34	0.056(0.31)	0.3(0.66)
103H5208-5240	-5210	0.39(55.23)	1	4.1	9.5	0.056(0.31)	0.3(0.66)
103H5209-4240	-4210	0.425(60.18)	1	4.4	11	0.062(0.34)	0.31(0.68)
103H5209-5040	-5010	0.38(53.81)	0.25	71.4	132	0.062(0.34)	0.31(0.68)
103H5209-5140	-5110	0.41(58.06)	0.5	18.2	39	0.062(0.34)	0.31(0.68)
103H5209-5240	-5210	0.425(60.18)	1	4.4	11	0.062(0.34)	0.31(0.68)
103H5210-4240	-4210	0.51(72.22)	1	4.8	9.5	0.074(0.40)	0.37(0.82)
103H5210-5040	-5010	0.465(65.85)	0.25	80	123.3	0.074(0.40)	0.37(0.82)
103H5210-5140	-5110	0.49(69.39)	0.5	20	35	0.074(0.40)	0.37(0.82)
103H5210-5240	-5210	0.51(72.22)	1	4.8	9.5	0.074(0.40)	0.37(0.82)

Dimensions [Unit:mm(inch)]

103H5205-0440 (Single shaft)
103H5205-0410 (Double shaft)

Applicable connector (J.S.T. MFG., CO.)
Connector: EHR-6
Terminal: SEH-001T-P0.6

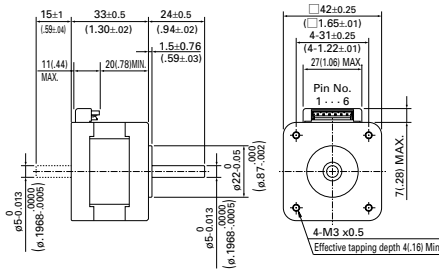

103H5208-0440 (Single shaft)
103H5208-0410 (Double shaft)

Applicable connector (J.S.T. MFG., CO.)
Connector: EHR-6
Terminal: SEH-001T-P0.6

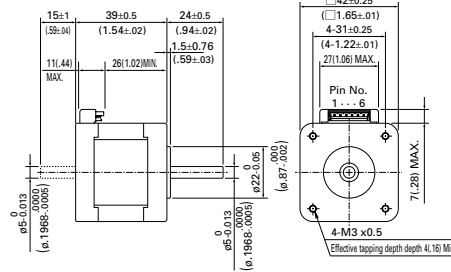

103H5209-0440 (Single shaft)
103H5209-0410 (Double shaft)

Applicable connector (J.S.T. MFG., CO.)
Connector: EHR-6
Terminal: SEH-001T-P0.6

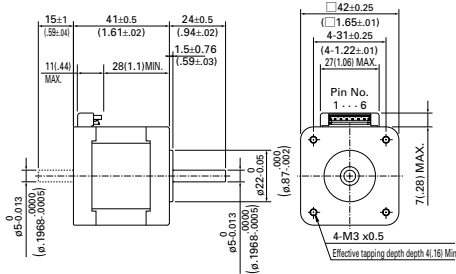

103H5210-0440 (Single shaft)
103H5210-0410 (Double shaft)

Applicable connector (J.S.T. MFG., CO.)
Connector: EHR-6
Terminal: SEH-001T-P0.6

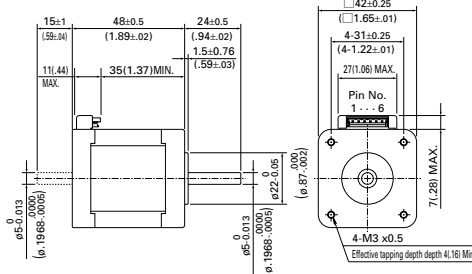

Bipolar winding

103H520 □-□□ 40 (Single shaft)
103H520 □-□□ 10 (Double shaft)

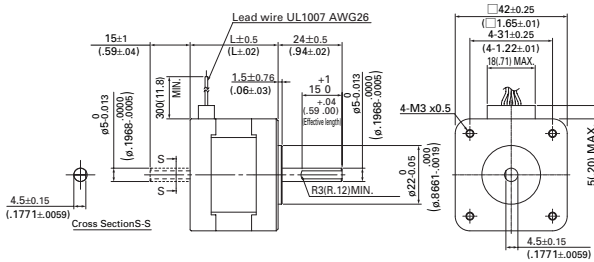

Model	L
103H5205-□□□□	33 (1.30)
103H5208-□□□□	39 (1.54)
103H5209-□□□□	41 (1.61)
103H5210-□□□□	48 (1.89)

35mm(1.38)/1.8"
38mm(1.54)/0.9"
42mm(1.65)/0.9"
28mm(1.10)/1.8"
42mm(1.65)/1.8"
50mm(1.97)/1.8"
56mm(2.20)/1.8"
60mm(2.36)/1.8"
86mm(3.39)/1.8"
106mm(4.17)/1.8"
106mm(4.17)/1.8"
86mm(3.39)/1.8"
106mm(4.17)/1.8"
Specifications of 2-phase stepping motor
In-vacuum stepping motor
2-phase synchronous motor

Pulse Rate - Torque Characteristics

103H5205-0440

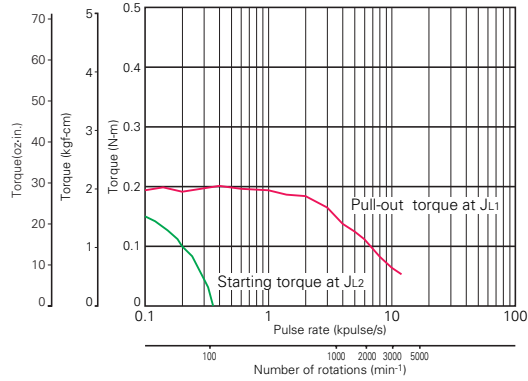

Sanyo constant current circuit
 Source voltage: DC24V Operating current : 1.2A/phase, 2-phase energization (full-step)
 $J_{L1}=[0.94 \times 10^{-4} \text{kg}\cdot\text{m}^2 (5.14 \text{ oz}\cdot\text{in}^2)]$ Use the rubber coupling]
 $J_{L2}=[0.8 \times 10^{-4} \text{kg}\cdot\text{m}^2 (4.37 \text{ oz}\cdot\text{in}^2)]$ Use the direct coupling]

103H5208-0440

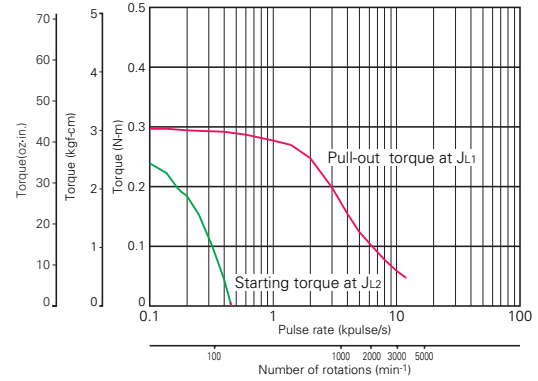

Sanyo constant current circuit
 Source voltage: DC24V Operating current : 1.2A/phase, 2-phase energization (full-step)
 $J_{L1}=[0.94 \times 10^{-4} \text{kg}\cdot\text{m}^2 (5.14 \text{ oz}\cdot\text{in}^2)]$ Use the rubber coupling]
 $J_{L2}=[0.8 \times 10^{-4} \text{kg}\cdot\text{m}^2 (4.37 \text{ oz}\cdot\text{in}^2)]$ Use the direct coupling]

103H5209-0440

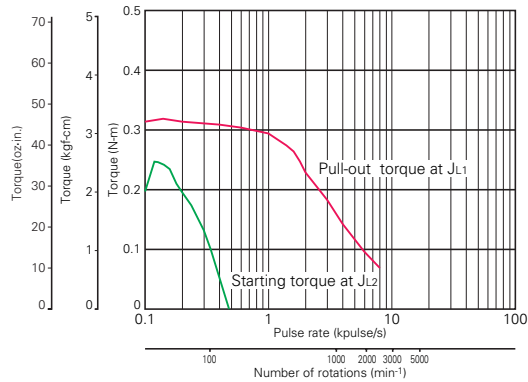

Sanyo constant current circuit
 Source voltage: DC24V Operating current : 1.2A/phase, 2-phase energization (full-step)
 $J_{L1}=[0.94 \times 10^{-4} \text{kg}\cdot\text{m}^2 (5.14 \text{ oz}\cdot\text{in}^2)]$ Use the rubber coupling]
 $J_{L2}=[0.8 \times 10^{-4} \text{kg}\cdot\text{m}^2 (4.37 \text{ oz}\cdot\text{in}^2)]$ Use the direct coupling]

103H5210-0440

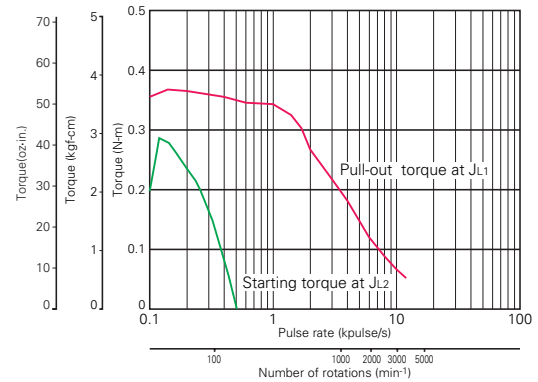

Sanyo constant current circuit
 Source voltage: DC24V Operating current : 1.2A/phase, 2-phase energization (full-step)
 $J_{L1}=[0.94 \times 10^{-4} \text{kg}\cdot\text{m}^2 (5.14 \text{ oz}\cdot\text{in}^2)]$ Use the rubber coupling]
 $J_{L2}=[0.8 \times 10^{-4} \text{kg}\cdot\text{m}^2 (4.37 \text{ oz}\cdot\text{in}^2)]$ Use the direct coupling]

103H5205-4240

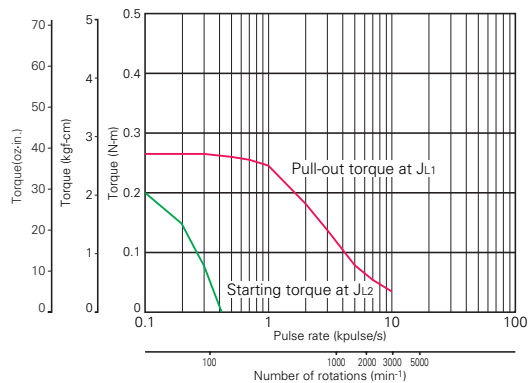

Sanyo constant current circuit
 Source voltage: DC24V Operating current : 1A/phase, 2-phase energization (full-step)
 $J_{L1}=[0.94 \times 10^{-4} \text{kg}\cdot\text{m}^2 (5.14 \text{ oz}\cdot\text{in}^2)]$ Use the rubber coupling]
 $J_{L2}=[0.8 \times 10^{-4} \text{kg}\cdot\text{m}^2 (4.37 \text{ oz}\cdot\text{in}^2)]$ Use the direct coupling]

103H5205-5040

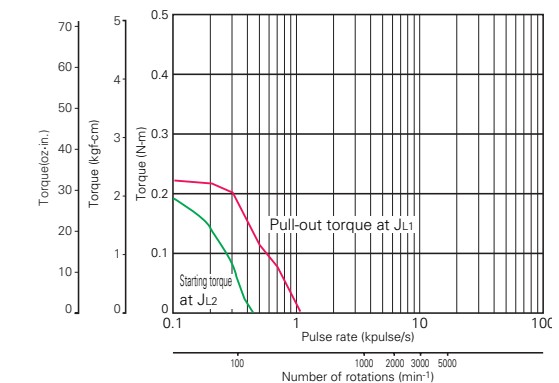

Sanyo constant current circuit
 Source voltage: DC24V Operating current : 25A/phase, 2-phase energization (full-step)
 $J_{L1}=[0.94 \times 10^{-4} \text{kg}\cdot\text{m}^2 (5.14 \text{ oz}\cdot\text{in}^2)]$ Use the rubber coupling]
 $J_{L2}=[0.8 \times 10^{-4} \text{kg}\cdot\text{m}^2 (4.37 \text{ oz}\cdot\text{in}^2)]$ Use the direct coupling]

Pulse Rate - Torque Characteristics

● 103H5205-5140

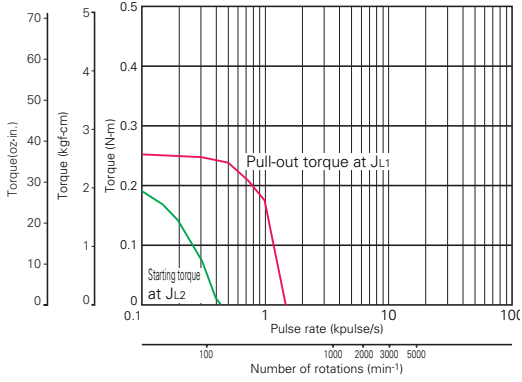

Sanyo constant current circuit
Source voltage: DC24V Operating current : 0.5A/phase, 2-phase energization (full-step)
JL1=[0.94x10⁻⁴kg·m² (5.14 oz-in²) Use the rubber coupling]
JL2=[0.8x10⁻⁴kg·m² (4.37 oz-in²) Use the direct coupling]

● 103H5205-5240

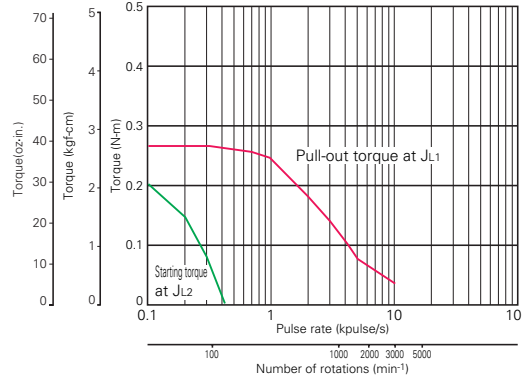

Sanyo constant current circuit
Source voltage: DC24V Operating current : 1A/phase, 2-phase energization (full-step)
JL1=[0.94x10⁻⁴kg·m² (5.14 oz-in²) Use the rubber coupling]
JL2=[0.8x10⁻⁴kg·m² (4.37 oz-in²) Use the direct coupling]

● 103H5208-4240

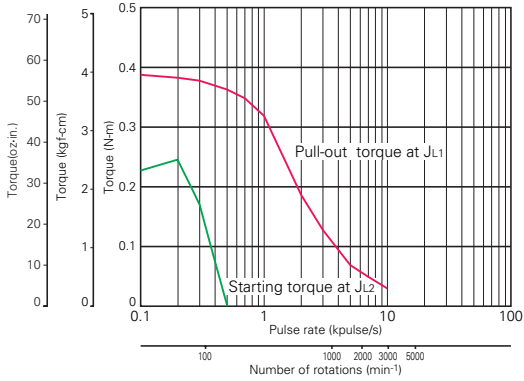

Sanyo constant current circuit
Source voltage: DC24V Operating current : 1A/phase, 2-phase energization (full-step)
JL1=[0.94x10⁻⁴kg·m² (5.14 oz-in²) Use the rubber coupling]
JL2=[0.8x10⁻⁴kg·m² (4.37 oz-in²) Use the direct coupling]

● 103H5208-5040

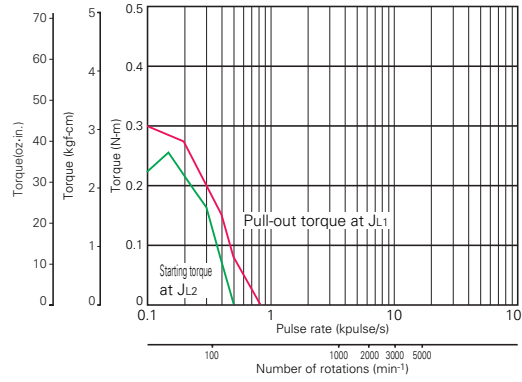

Sanyo constant current circuit
Source voltage: DC24V Operating current : 0.25A/phase, 2-phase energization (full-step)
JL1=[0.94x10⁻⁴kg·m² (5.14 oz-in²) Use the rubber coupling]
JL2=[0.8x10⁻⁴kg·m² (4.37 oz-in²) Use the direct coupling]

● 103H5208-5140

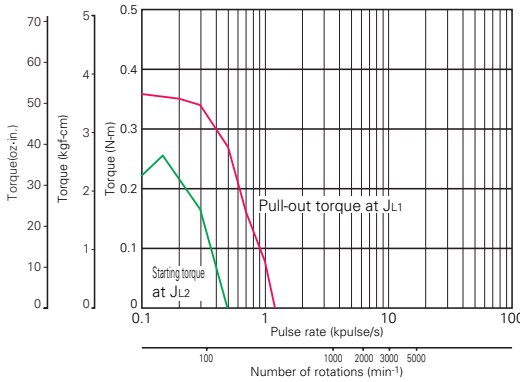

Sanyo constant current circuit
Source voltage: DC24V Operating current : 0.5A/phase, 2-phase energization (full-step)
JL1=[0.94x10⁻⁴kg·m² (5.14 oz-in²) Use the rubber coupling]
JL2=[0.8x10⁻⁴kg·m² (4.37 oz-in²) Use the direct coupling]

● 103H5208-5240

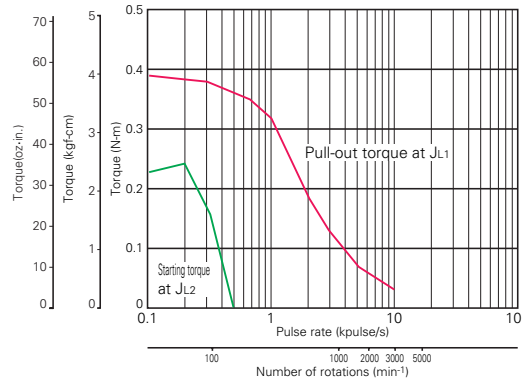

Sanyo constant current circuit
Source voltage: DC24V Operating current : 1A/phase, 2-phase energization (full-step)
JL1=[0.94x10⁻⁴kg·m² (5.14 oz-in²) Use the rubber coupling]
JL2=[0.8x10⁻⁴kg·m² (4.37 oz-in²) Use the direct coupling]

Specifications of 2-phase synchronous motor
 In-vacuum stepping motor
 ø106mm(4.17)/CE
 ø86mm(3.39)/CE
 ø106mm(4.17)/1.8
 ø86mm(3.39)/1.8
 ø60mm(2.36)/1.8
 ø56mm(2.20)/1.8
 ø50mm(1.97)/1.8
 ø42mm(1.65)/1.8
 ø28mm(1.10)/1.8
 ø22mm(0.87)/0.9
 ø38mm(1.54)/0.9
 ø35mm(1.38)/1.8

Pulse Rate - Torque Characteristics

● 103H5209-4240

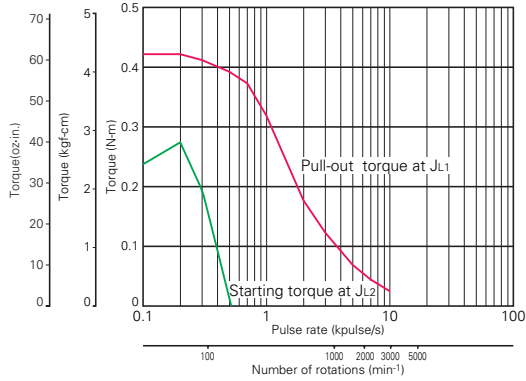

Sanyo constant current circuit
 Source voltage: DC24V Operating current : 1A/phase, 2-phase energization (full-step)
 $J_{L1}=[0.94 \times 10^{-4} \text{kg}\cdot\text{m}^2 (5.14 \text{ oz}\cdot\text{in}^2)$ Use the rubber coupling]
 $J_{L2}=[0.8 \times 10^{-4} \text{kg}\cdot\text{m}^2 (4.37 \text{ oz}\cdot\text{in}^2)$ Use the direct coupling]

● 103H5209-5040

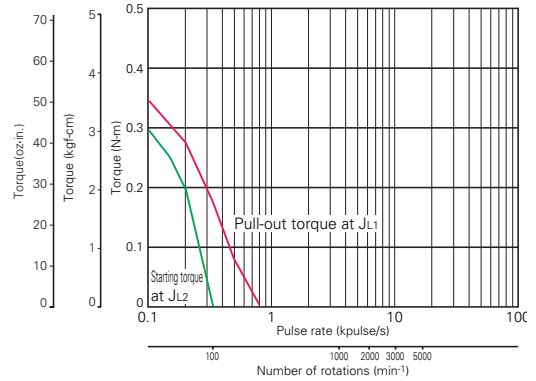

Sanyo constant current circuit
 Source voltage: DC24V Operating current : 0.25A/phase, 2-phase energization (full-step)
 $J_{L1}=[0.94 \times 10^{-4} \text{kg}\cdot\text{m}^2 (5.14 \text{ oz}\cdot\text{in}^2)$ Use the rubber coupling]
 $J_{L2}=[0.8 \times 10^{-4} \text{kg}\cdot\text{m}^2 (4.37 \text{ oz}\cdot\text{in}^2)$ Use the direct coupling]

● 103H5209-5140

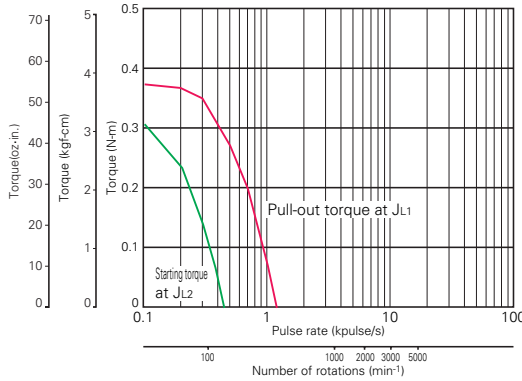

Sanyo constant current circuit
 Source voltage: DC24V Operating current : 0.5A/phase, 2-phase energization (full-step)
 $J_{L1}=[0.94 \times 10^{-4} \text{kg}\cdot\text{m}^2 (5.14 \text{ oz}\cdot\text{in}^2)$ Use the rubber coupling]
 $J_{L2}=[0.8 \times 10^{-4} \text{kg}\cdot\text{m}^2 (4.37 \text{ oz}\cdot\text{in}^2)$ Use the direct coupling]

● 103H5209-5240

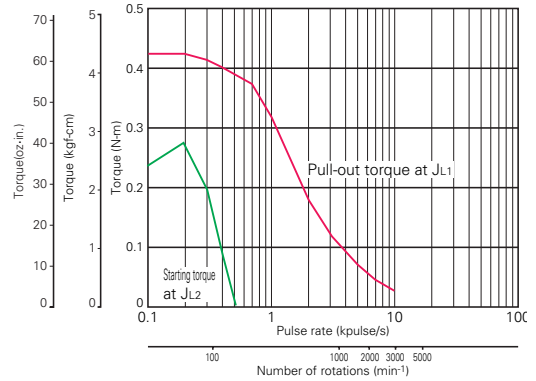

Sanyo constant current circuit
 Source voltage: DC24V Operating current : 1A/phase, 2-phase energization (full-step)
 $J_{L1}=[0.94 \times 10^{-4} \text{kg}\cdot\text{m}^2 (5.14 \text{ oz}\cdot\text{in}^2)$ Use the rubber coupling]
 $J_{L2}=[0.8 \times 10^{-4} \text{kg}\cdot\text{m}^2 (4.37 \text{ oz}\cdot\text{in}^2)$ Use the direct coupling]

● 103H5210-4240

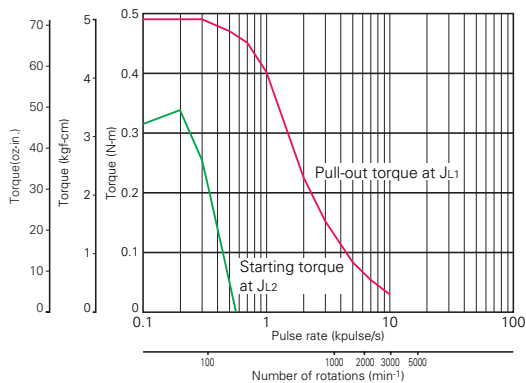

Sanyo constant current circuit
 Source voltage: DC24V Operating current : 1A/phase, 2-phase energization (full-step)
 $J_{L1}=[0.94 \times 10^{-4} \text{kg}\cdot\text{m}^2 (5.14 \text{ oz}\cdot\text{in}^2)$ Use the rubber coupling]
 $J_{L2}=[0.8 \times 10^{-4} \text{kg}\cdot\text{m}^2 (4.37 \text{ oz}\cdot\text{in}^2)$ Use the direct coupling]

● 103H5210-5040

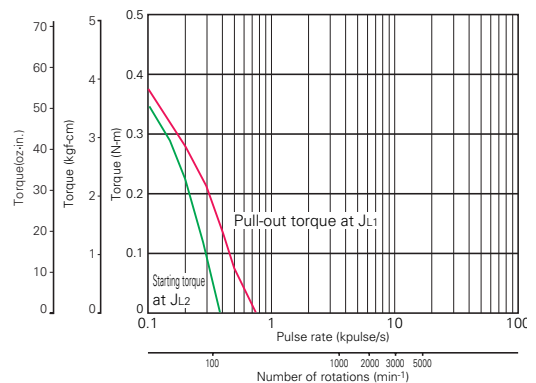

Sanyo constant current circuit
 Source voltage: DC24V Operating current : 0.25A/phase, 2-phase energization (full-step)
 $J_{L1}=[0.94 \times 10^{-4} \text{kg}\cdot\text{m}^2 (5.14 \text{ oz}\cdot\text{in}^2)$ Use the rubber coupling]
 $J_{L2}=[0.8 \times 10^{-4} \text{kg}\cdot\text{m}^2 (4.37 \text{ oz}\cdot\text{in}^2)$ Use the direct coupling]

Pulse Rate - Torque Characteristics

● 103H5210-5140

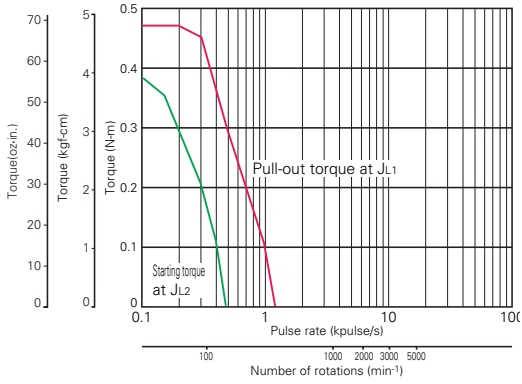

Sanyo constant current circuit
 Source voltage: DC24V Operating current : 0.5A/phase, 2-phase energization (full-step)
 $J_{L1}=[0.94 \times 10^{-4} \text{kg} \cdot \text{m}^2 (5.14 \text{ oz} \cdot \text{in}^2)]$ Use the rubber coupling]
 $J_{L2}=[0.8 \times 10^{-4} \text{kg} \cdot \text{m}^2 (4.37 \text{ oz} \cdot \text{in}^2)]$ Use the direct coupling]

● 103H5210-5240

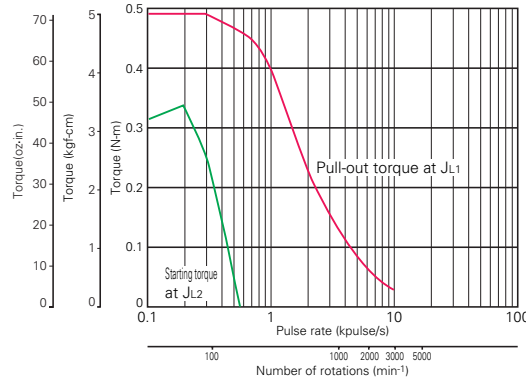

Sanyo constant current circuit
 Source voltage: DC24V Operating current : 1A/phase, 2-phase energization (full-step)
 $J_{L1}=[0.94 \times 10^{-4} \text{kg} \cdot \text{m}^2 (5.14 \text{ oz} \cdot \text{in}^2)]$ Use the rubber coupling]
 $J_{L2}=[0.8 \times 10^{-4} \text{kg} \cdot \text{m}^2 (4.37 \text{ oz} \cdot \text{in}^2)]$ Use the direct coupling]

- 35mm(1.38)/1.8"
- 38mm(1.54)/0.9"
- 42mm(1.65)/0.9"
- 28mm(1.10)/1.8"
- 42mm(1.65)/1.8"
- 50mm(1.97)/1.8"
- 56mm(2.20)/1.8"
- 60mm(2.36)/1.8"
- 86mm(3.39)/1.8"
- 106mm(4.17)/1.8"
- 56mm(2.20)/CE
- 86mm(3.39)/CE
- 106mm(4.17)/CE
- Specifications of 2-phase stepping motor
- In-vacuum stepping motor
- 2-phase synchronous motor



2-phase Stepping Motor

50mm sq. 103H670 □
(1.97inch sq.) 1.8°/step

Recommendable Driver
 Refer to the page 7,17,27 and 45.

Specifications

Unipolar winding

Model		Holding torque at 2-phase energization N·m(oz-in) MIN.	Rated current A/phase	Resistance Ω/phase	Inductance mH/phase	Rotor inertia x10 ⁻⁴ kg·m ² (oz-in ²)	Mass(Weight) kg(lbs)
Single shaft	Double shaft						
103H6701-0140	-0110	0.28(39.6)	1	4.3	6.8	0.057(0.31)	0.35(0.77)
103H6701-0440	-0410	0.28(39.6)	2	1.1	1.6	0.057(0.31)	0.35(0.77)
103H6701-0740	-0710	0.28(39.6)	3	0.6	0.7	0.057(0.31)	0.35(0.77)
103H6703-0140	-0110	0.49(69.4)	1	6	13	0.118(0.65)	0.5(1.10)
103H6703-0440	-0410	0.49(69.4)	2	1.6	3.2	0.118(0.65)	0.5(1.10)
103H6703-0740	-0710	0.49(69.4)	3	0.83	1.4	0.118(0.65)	0.5(1.10)
103H6704-0140	-0110	0.53(75.1)	1	6.5	16.5	0.14(0.77)	0.55(1.21)
103H6704-0440	-0410	0.52(73.6)	2	1.7	3.8	0.14(0.77)	0.55(1.21)
103H6704-0740	-0710	0.53(75.1)	3	0.9	1.7	0.14(0.77)	0.55(1.21)

Bipolar winding

Model		Holding torque at 2-phase energization N·m(oz-in) MIN.	Rated current A/phase	Resistance Ω/phase	Inductance mH/phase	Rotor inertia x10 ⁻⁴ kg·m ² (oz-in ²)	Mass(Weight) kg(lbs)
Single shaft	Double shaft						
103H6704-5040	-5010	0.52(73.6)	2	0.9	3.8	0.14(0.77)	0.55(1.21)

Dimensions [Unit:mm(inch)]

103H6701-0140/0440/0740 (Single shaft)
103H6701-0110/0410/0710 (Double shaft)

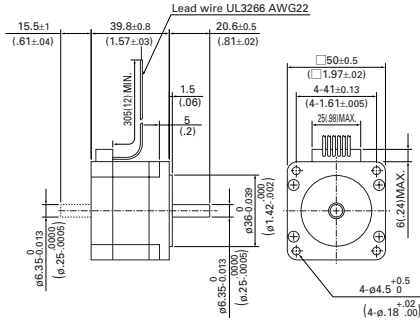

103H6703-0140/0440/0740 (Single shaft)
103H6703-0110/0410/0710 (Double shaft)

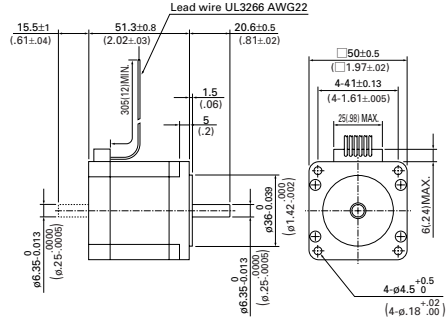

103H6704-0140/0440/0740/5040 (Single shaft)
103H6704-0110/0410/0710/5010 (Double shaft)

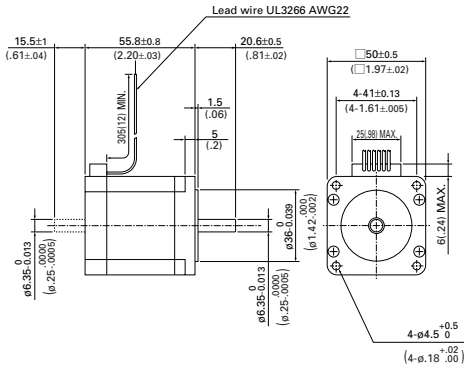

Bipolar winding
103H6704-5040(Single shaft)
103H6704-5010(Double shaft)

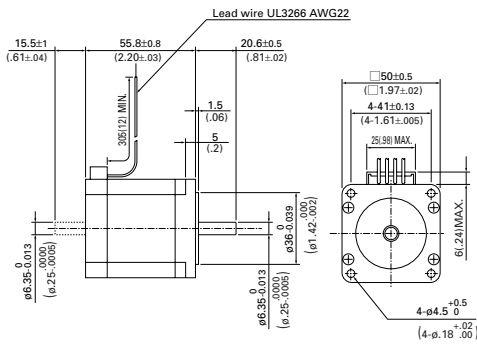

35mm(1.38)/1.8"
 38mm(1.54)/0.9"
 42mm(1.65)/0.9"
 28mm(1.10)/1.8"
 42mm(1.65)/1.8"
 50mm(1.97)/1.8"
 56mm(2.20)/1.8"
 60mm(2.36)/1.8"
 88mm(3.39)/1.8"
 106mm(4.17)/1.8"
 2-phase synchronous motor
 In-vacuum stepping motor
 Specifications of 2-phase stepping motor

Pulse Rate - Torque Characteristics

103H6701-0140

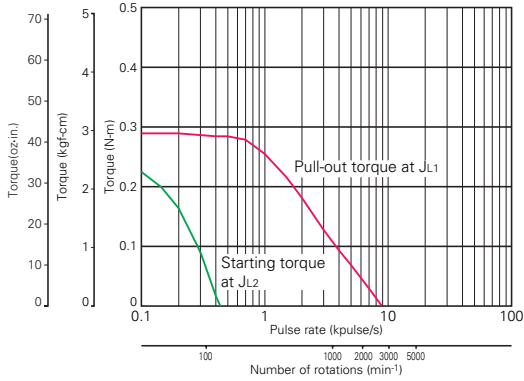

Sanyo constant current circuit

Source voltage: DC24V Operating current : 1A/phase, 2-phase energization (full-step)
 $J_{L1}=[0.94 \times 10^{-4} \text{kg} \cdot \text{m}^2 (5.14 \text{ oz} \cdot \text{in}^2)]$ Use the rubber coupling)
 $J_{L2}=[0.8 \times 10^{-4} \text{kg} \cdot \text{m}^2 (4.37 \text{ oz} \cdot \text{in}^2)]$ Use the direct coupling)

103H6703-0140

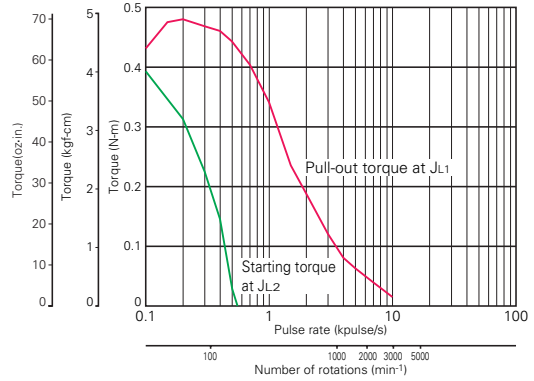

Sanyo constant current circuit

Source voltage: DC24V Operating current : 1A/phase, 2-phase energization (full-step)
 $J_{L1}=[0.94 \times 10^{-4} \text{kg} \cdot \text{m}^2 (5.14 \text{ oz} \cdot \text{in}^2)]$ Use the rubber coupling)
 $J_{L2}=[0.8 \times 10^{-4} \text{kg} \cdot \text{m}^2 (4.37 \text{ oz} \cdot \text{in}^2)]$ Use the direct coupling)

103H6701-0440

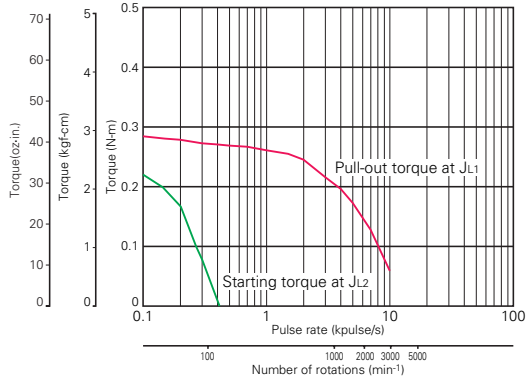

Sanyo constant current circuit

Source voltage: DC24V Operating current : 2A/phase, 2-phase energization (full-step)
 $J_{L1}=[0.94 \times 10^{-4} \text{kg} \cdot \text{m}^2 (5.14 \text{ oz} \cdot \text{in}^2)]$ Use the rubber coupling)
 $J_{L2}=[0.8 \times 10^{-4} \text{kg} \cdot \text{m}^2 (4.37 \text{ oz} \cdot \text{in}^2)]$ Use the direct coupling)

103H6703-0440

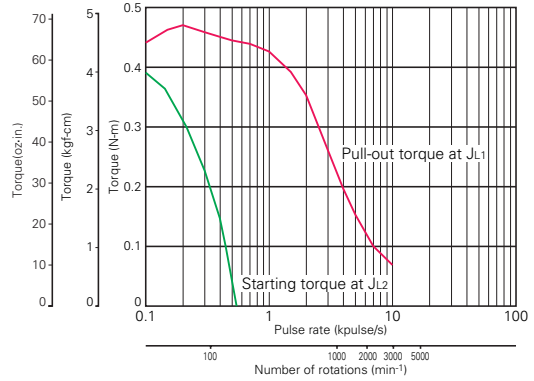

Sanyo constant current circuit

Source voltage: DC24V Operating current : 2A/phase, 2-phase energization (full-step)
 $J_{L1}=[0.94 \times 10^{-4} \text{kg} \cdot \text{m}^2 (5.14 \text{ oz} \cdot \text{in}^2)]$ Use the rubber coupling)
 $J_{L2}=[0.8 \times 10^{-4} \text{kg} \cdot \text{m}^2 (4.37 \text{ oz} \cdot \text{in}^2)]$ Use the direct coupling)

103H6701-0740

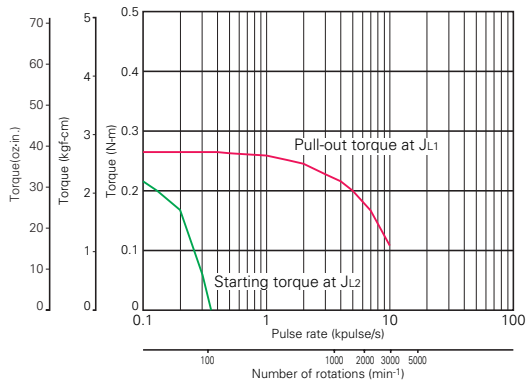

Sanyo constant current circuit

Source voltage: DC24V Operating current : 3A/phase, 2-phase energization (full-step)
 $J_{L1}=[0.94 \times 10^{-4} \text{kg} \cdot \text{m}^2 (5.14 \text{ oz} \cdot \text{in}^2)]$ Use the rubber coupling)
 $J_{L2}=[0.8 \times 10^{-4} \text{kg} \cdot \text{m}^2 (4.37 \text{ oz} \cdot \text{in}^2)]$ Use the direct coupling)

103H6703-0740

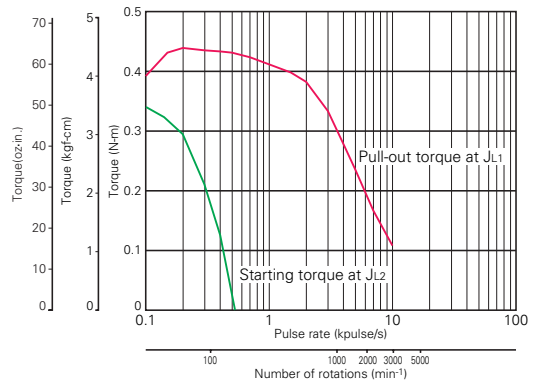

Sanyo constant current circuit

Source voltage: DC24V Operating current : 3A/phase, 2-phase energization (full-step)
 $J_{L1}=[0.94 \times 10^{-4} \text{kg} \cdot \text{m}^2 (5.14 \text{ oz} \cdot \text{in}^2)]$ Use the rubber coupling)
 $J_{L2}=[0.8 \times 10^{-4} \text{kg} \cdot \text{m}^2 (4.37 \text{ oz} \cdot \text{in}^2)]$ Use the direct coupling)

Pulse Rate - Torque Characteristics

● 103H6704-0140

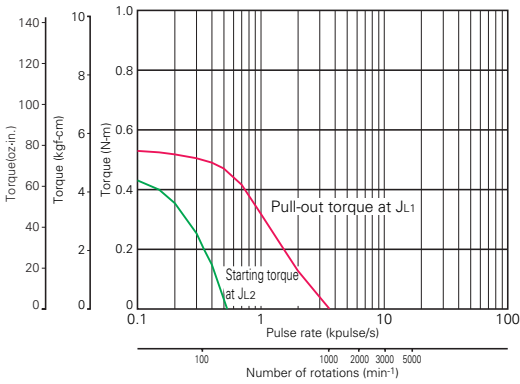

Sanyo constant current circuit
 Source voltage: DC24V Operating current : 1A/phase, 2-phase energization (full-step)
 JL1=[0.94x10⁻⁴kg·m² (5.14 oz-in²) Use the rubber coupling]
 JL2=[0.8x10⁻⁴kg·m² (4.37 oz-in²) Use the directcoupling]

● 103H6704-5040

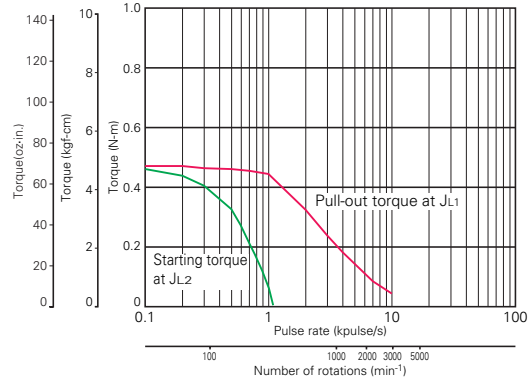

Sanyo constant current circuit
 Source voltage: DC24V Operating current : 2A/phase, 2-phase energization (full-step)
 JL1=[0.94x10⁻⁴kg·m² (5.14 oz-in²) Use the rubber coupling]
 JL2=[0.14x10⁻⁴kg·m² (4.37 oz-in²) Use the direct coupling]

● 103H6704-0440

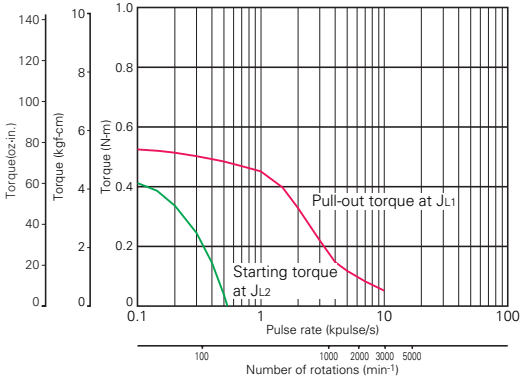

Sanyo constant current circuit
 Source voltage: DC24V Operating current : 2A/phase, 2-phase energization (full-step)
 JL1=[0.94x10⁻⁴kg·m² (5.14 oz-in²) Use the rubber coupling]
 JL2=[0.8x10⁻⁴kg·m² (4.37 oz-in²) Use the direct coupling]

● 103H6704-0740

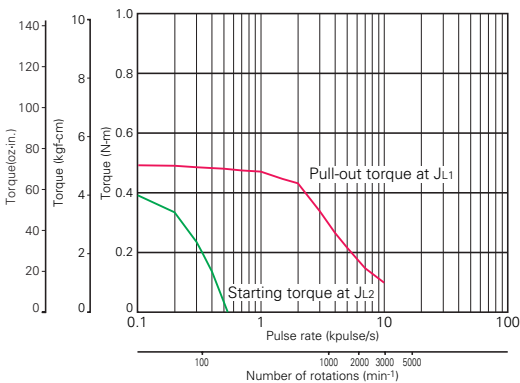

Sanyo constant current circuit
 Source voltage: DC24V Operating current : 3A/phase, 2-phase energization (full-step)
 JL1=[0.94x10⁻⁴kg·m² (5.14 oz-in²) Use the rubber coupling]
 JL2=[0.8x10⁻⁴kg·m² (4.37 oz-in²) Use the direct coupling]

○35mm(1.38)/1.8"
 ○38mm(1.54)/0.9"
 ○42mm(1.65)/0.9"
 ○28mm(1.10)/1.8"
 ○42mm(1.65)/1.8"
 ○50mm(1.97)/1.8"
 ○56mm(2.20)/1.8"
 ○60mm(2.36)/1.8"
 ○86mm(3.39)/1.8"
 ○106mm(4.17)/1.8"
 ○56mm(2.20)/CE
 ○106mm(4.17)/CE
 ○86mm(3.39)/CE
 ○106mm(4.17)/CE
 In-vacuum stepping motor
 2-phase synchronous motor



2-phase Stepping Motor

56mm sq. 103H712□
(2.20inch sq.) 1.8°/step

Recommendable Driver
Refer to the page 7,17,27 and 45.

Specifications

Unipolar winding

Model		Holding torque at 2-phase energization N-m (oz-in) MIN.	Rated current		Inductance mH/phase	Rotor inertia x10 ⁻⁴ kg-m ² (oz-in ²)	Mass(Weight) kg(lbs)
Single shaft	Double shaft		A/phase	Ω/phase			
103H7121-0140	-0110	0.39(55.2)	1	4.8	8	0.1(0.55)	0.47(1.04)
103H7121-0440	-0410	0.39(55.2)	2	1.25	1.9	0.1(0.55)	0.47(1.04)
103H7121-0740	-0710	0.39(55.2)	3	0.6	0.8	0.1(0.55)	0.47(1.04)
103H7123-0140	-0110	0.83(117.)	1	6.7	15	0.21(1.15)	0.65(1.43)
103H7123-0440	-0410	0.83(117.5)	2	1.6	3.8	0.21(1.15)	0.65(1.43)
103H7123-0740	-0710	0.78(110.5)	3	0.77	1.58	0.21(1.15)	0.65(1.43)
103H7124-0140	-0110	0.98(138.8)	1	7	12.5	0.245(1.34)	0.8(1.76)
103H7124-0440	-0410	0.98(138.8)	2	1.7	3.1	0.245(1.34)	0.8(1.76)
103H7124-0740	-0710	0.98(138.8)	3	0.74	1.4	0.245(1.34)	0.8(1.76)
103H7126-0140	-0110	1.27(179.8)	1	8.6	19	0.36(1.97)	0.98(2.16)
103H7126-0440	-0410	1.27(179.8)	2	2	4.5	0.36(1.97)	0.98(2.16)
103H7126-0740	-0710	1.27(179.8)	3	0.9	2.2	0.36(1.97)	0.98(2.16)

Bipolar winding

Model		Holding torque at 2-phase energization N-m (oz-in) MIN.	Rated current		Inductance mH/phase	Rotor inertia x10 ⁻⁴ kg-m ² (oz-in ²)	Mass(Weight) kg(lbs)
Single shaft	Double shaft		A/phase	Ω/phase			
103H71215040	-5010	0.39(55.2)	2	0.65	1.9	0.1(0.55)	0.47(1.04)
103H7121-5640	-5610	0.55(77.9)	1	4.3	14.5	0.1(0.55)	0.47(1.04)
103H7121-5740	-5710	0.55(77.9)	2	1.1	3.7	0.1(0.55)	0.47(1.04)
103H7121-5840	-5810	0.55(77.9)	3	0.54	1.74	0.1(0.55)	0.47(1.04)
103H71235040	-5010	0.83(117.5)	2	0.8	3.8	0.21(1.15)	0.65(1.43)
103H7123-5640	-5610	1.0(141.6)	1	5.7	29.4	0.21(1.15)	0.65(1.43)
103H7123-5740	-5710	1.0(141.6)	2	1.5	7.5	0.21(1.15)	0.65(1.43)
103H7123-5840	-5810	1.0(141.6)	3	0.7	3.5	0.21(1.15)	0.65(1.43)
103H7126-5040	-5010	1.27(179.8)	2	1.05	4.5	0.36(1.97)	0.98(2.16)
103H7126-5640	-5610	1.6(226.6)	1	7.7	34.6	0.36(1.97)	0.98(2.16)
103H7126-5740	-5710	1.6(226.6)	2	2	9.1	0.36(1.97)	0.98(2.16)
103H7126-5840	-5810	1.6(226.6)	3	0.94	4	0.36(1.97)	0.98(2.16)
103H7128-5640	-5610	2(283.2)	1	8.9	40.1	0.49(2.68)	1.3(2.87)
103H7128-5740	-5710	2(283.2)	2	2.3	10.4	0.49(2.68)	1.3(2.87)
103H7128-5840	-5810	2(283.2)	3	1.03	4.3	0.49(2.68)	1.3(2.87)

Dimensions [Unit:mm(inch)]

103H7121-0140/0440/0740/5040 (Single shaft)
103H7121-0110/0410/0710/5010 (Double shaft)

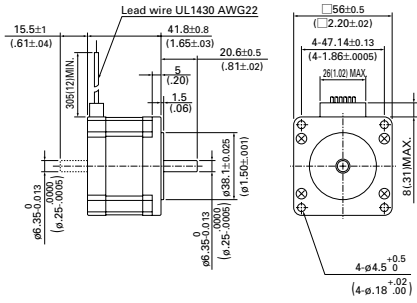

103H7123-0140/0440/0740/5040 (Single shaft)
103H7123-0110/0410/0710/5010 (Double shaft)

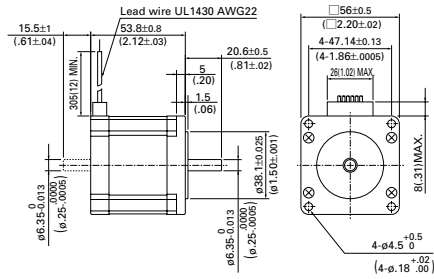

103H7124-0140/0440/0740 (Single shaft)
103H7124-0110/0410/0710 (Double shaft)

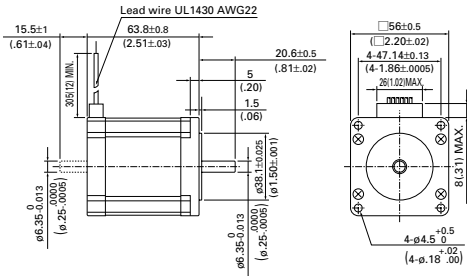

103H7126-0140/0440/0740/5040 (Single shaft)
103H7126-0110/0410/0710/5010 (Double shaft)

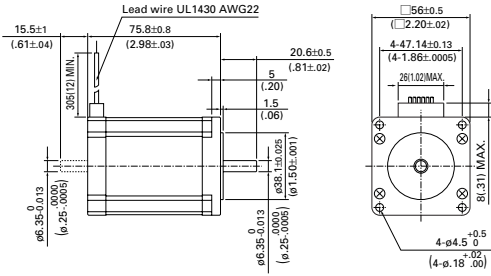

Bipolar winding

103H712-□-5□40 (Single shaft)
103H712-□-5□10 (Double shaft)

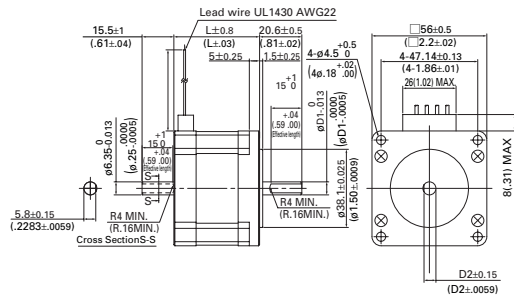

Model	L	D1	D2
103H7121-□□□□	41.8 (1.65)		
103H7123-□□□□	53.8 (2.12)	6.35 (.25)	5.8 (.23)
103H7126-□□□□	75.8 (2.98)		
103H7128-□□□□	94.8 (3.73)	8 (.3149)	7.5 (.30)

□35mm(1.38)/1.8"
 □38mm(1.54)/0.9"
 □42mm(1.65)/0.9"
 □28mm(1.10)/1.8"
 □42mm(1.65)/1.8"
 □50mm(1.97)/1.8"
 □56mm(2.20)/1.8"
 □60mm(2.36)/1.8"
 □85mm(3.39)/1.8"
 □106mm(4.17)/1.8"
 □56mm(2.20)/CE
 □86mm(3.39)/CE
 □106mm(4.17)/CE
 Specifications of 2-phase stepping motor
 In-vacuum stepping motor
 2-phase synchronous motor

Pulse Rate - Torque Characteristics

● 103H7121-0140

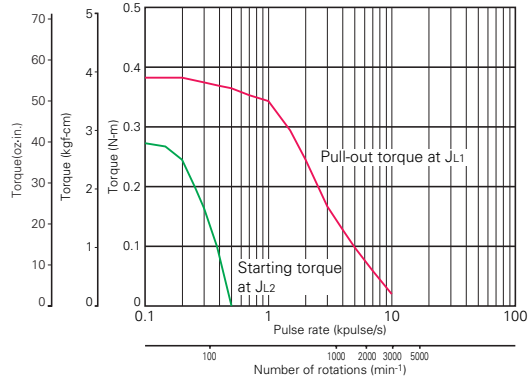

Sanyo constant current circuit
 Source voltage: DC24V Operating current : 1A/phase, 2-phase energization (full-step)
 $J_{L1}=[0.94 \times 10^{-4} \text{kg} \cdot \text{m}^2 (5.14 \text{ oz} \cdot \text{in}^2)]$ Use the rubber coupling]
 $J_{L2}=[0.8 \times 10^{-4} \text{kg} \cdot \text{m}^2 (4.37 \text{ oz} \cdot \text{in}^2)]$ Use the direct coupling]

● 103H7123-0140

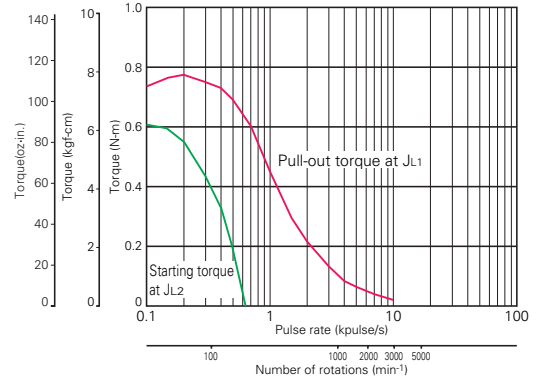

Sanyo constant current circuit
 Source voltage: DC24V Operating current : 1A/phase, 2-phase energization (full-step)
 $J_{L1}=[0.94 \times 10^{-4} \text{kg} \cdot \text{m}^2 (5.14 \text{ oz} \cdot \text{in}^2)]$ Use the rubber coupling]
 $J_{L2}=[0.8 \times 10^{-4} \text{kg} \cdot \text{m}^2 (4.37 \text{ oz} \cdot \text{in}^2)]$ Use the direct coupling]

● 103H7121-0440

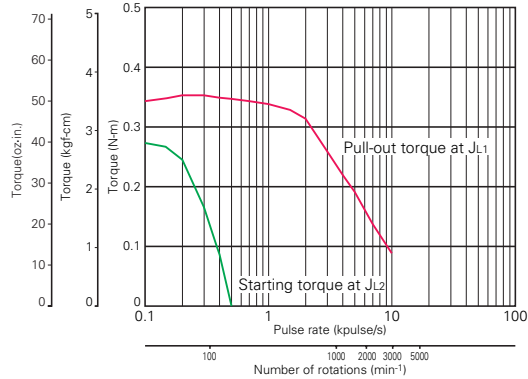

Sanyo constant current circuit
 Source voltage: DC24V Operating current : 2A/phase, 2-phase energization (full-step)
 $J_{L1}=[0.94 \times 10^{-4} \text{kg} \cdot \text{m}^2 (5.14 \text{ oz} \cdot \text{in}^2)]$ Use the rubber coupling]
 $J_{L2}=[0.8 \times 10^{-4} \text{kg} \cdot \text{m}^2 (4.37 \text{ oz} \cdot \text{in}^2)]$ Use the direct coupling]

● 103H7123-0440

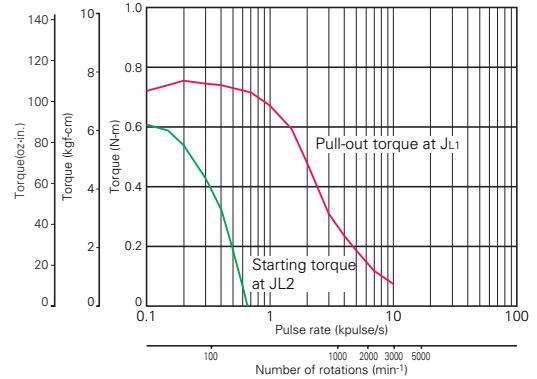

Sanyo constant current circuit
 Source voltage: DC24V Operating current : 2A/phase, 2-phase energization (full-step)
 $J_{L1}=[0.94 \times 10^{-4} \text{kg} \cdot \text{m}^2 (5.14 \text{ oz} \cdot \text{in}^2)]$ Use the rubber coupling]
 $J_{L2}=[0.8 \times 10^{-4} \text{kg} \cdot \text{m}^2 (4.37 \text{ oz} \cdot \text{in}^2)]$ Use the direct coupling]

● 103H7121-0740

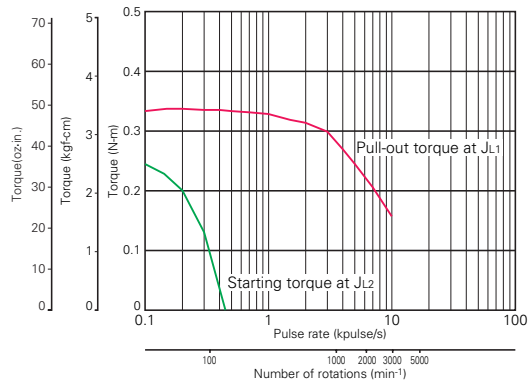

Sanyo constant current circuit
 Source voltage: DC24V Operating current : 3A/phase, 2-phase energization (full-step)
 $J_{L1}=[0.94 \times 10^{-4} \text{kg} \cdot \text{m}^2 (5.14 \text{ oz} \cdot \text{in}^2)]$ Use the rubber coupling]
 $J_{L2}=[0.8 \times 10^{-4} \text{kg} \cdot \text{m}^2 (4.37 \text{ oz} \cdot \text{in}^2)]$ Use the direct coupling]

● 103H7123-0740

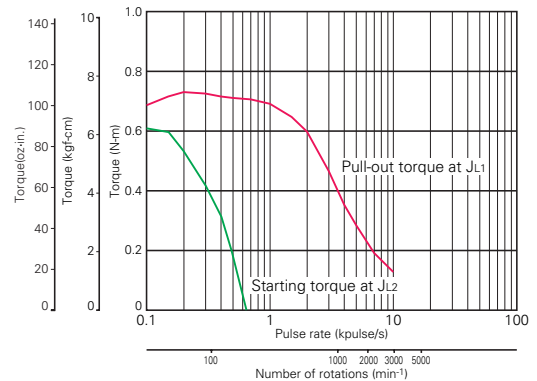

Sanyo constant current circuit
 Source voltage: DC24V Operating current : 3A/phase, 2-phase energization (full-step)
 $J_{L1}=[0.94 \times 10^{-4} \text{kg} \cdot \text{m}^2 (5.14 \text{ oz} \cdot \text{in}^2)]$ Use the rubber coupling]
 $J_{L2}=[0.8 \times 10^{-4} \text{kg} \cdot \text{m}^2 (4.37 \text{ oz} \cdot \text{in}^2)]$ Use the direct coupling]

Pulse Rate - Torque Characteristics

● 103H7124-0140

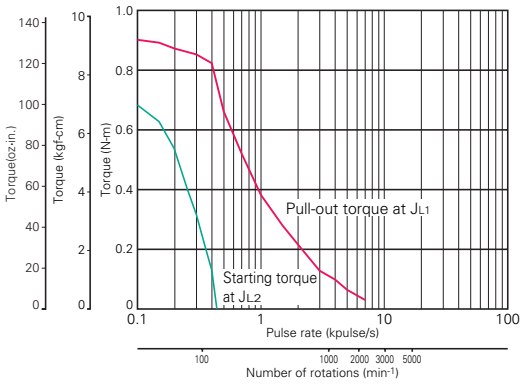

Sanyo constant current circuit
 Source voltage: DC24V Operating current : 1A/phase, 2-phase energization (full-step)
 J_{L1}=[2.6x10⁻⁴kg-m² (14.22 oz-in²) Use the rubber coupling]
 J_{L2}=[2.6x10⁻⁴kg-m² (14.22 oz-in²) Use the direct coupling]

● 103H7126-0140

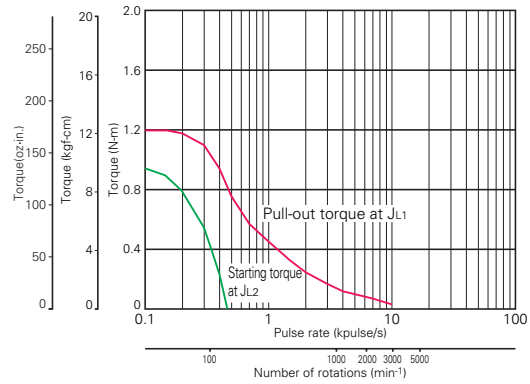

Sanyo constant current circuit
 Source voltage: DC24V Operating current : 1A/phase, 2-phase energization (full-step)
 J_{L1}=[2.6x10⁻⁴kg-m² (14.22 oz-in²) Use the rubber coupling]
 J_{L2}=[2.6x10⁻⁴kg-m² (14.22 oz-in²) Use the direct coupling]

● 103H7124-0440

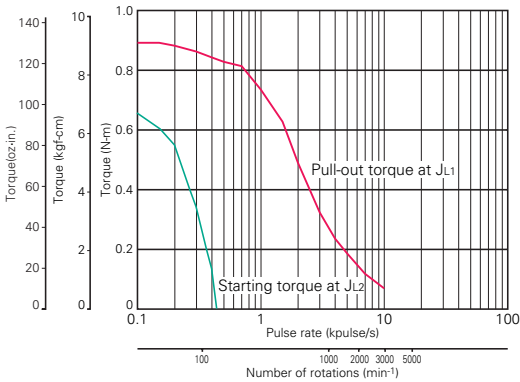

Sanyo constant current circuit
 Source voltage: DC24V Operating current : 2A/phase, 2-phase energization (full-step)
 J_{L1}=[2.6x10⁻⁴kg-m² (14.22 oz-in²) Use the rubber coupling]
 J_{L2}=[2.6x10⁻⁴kg-m² (14.22 oz-in²) Use the direct coupling]

● 103H7126-0440

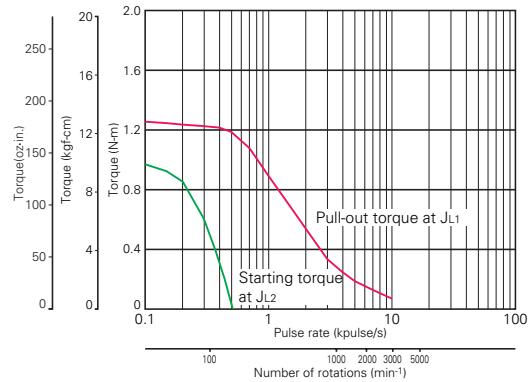

Sanyo constant current circuit
 Source voltage: DC24V Operating current : 2A/phase, 2-phase energization (full-step)
 J_{L1}=[2.6x10⁻⁴kg-m² (14.22 oz-in²) Use the rubber coupling]
 J_{L2}=[2.6x10⁻⁴kg-m² (14.22 oz-in²) Use the direct coupling]

● 103H7124-0740

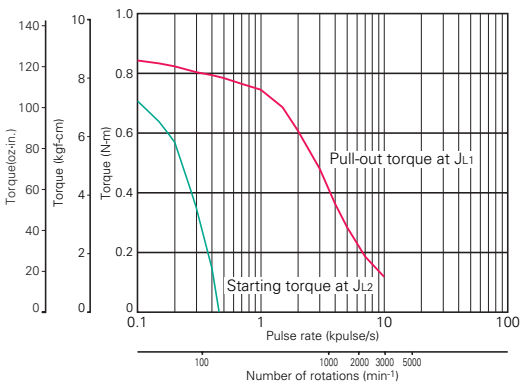

Sanyo constant current circuit
 Source voltage: DC24V Operating current : 3A/phase, 2-phase energization (full-step)
 J_{L1}=[2.6x10⁻⁴kg-m² (14.22 oz-in²) Use the rubber coupling]
 J_{L2}=[2.6x10⁻⁴kg-m² (14.22 oz-in²) Use the direct coupling]

● 103H7126-0740

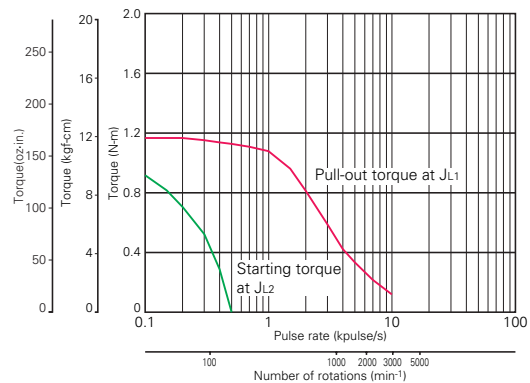

Sanyo constant current circuit
 Source voltage: DC24V Operating current : 3A/phase, 2-phase energization (full-step)
 J_{L1}=[2.6x10⁻⁴kg-m² (14.22 oz-in²) Use the rubber coupling]
 J_{L2}=[2.6x10⁻⁴kg-m² (14.22 oz-in²) Use the direct coupling]

Specifications of 2-phase stepping motor
 In-vacuum stepping motor
 2-phase synchronous motor
 φ106mm(4.17)/1.8
 φ86mm(3.39)/1.8
 φ60mm(2.36)/1.8
 φ56mm(2.20)/1.8
 φ42mm(1.65)/1.8
 φ28mm(1.10)/1.8
 φ38mm(1.54)/0.9
 φ35mm(1.38)/1.8
 φ42mm(1.65)/0.9

Pulse Rate - Torque Characteristics

● 103H7121-5040

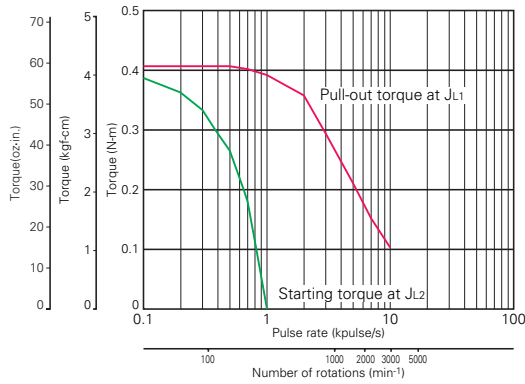

Sanyo constant current circuit

Source voltage: DC24V Operating current: 2A/phase, 2-phase energization (full-step)

J_{L1}=[0.94x10⁻⁴kg·m² (5.14 oz-in²) Use the rubber coupling]

J_{L2}=[0.8x10⁻⁴kg·m² (4.37 oz-in²) Use the direct coupling]

● 103H7121-5840

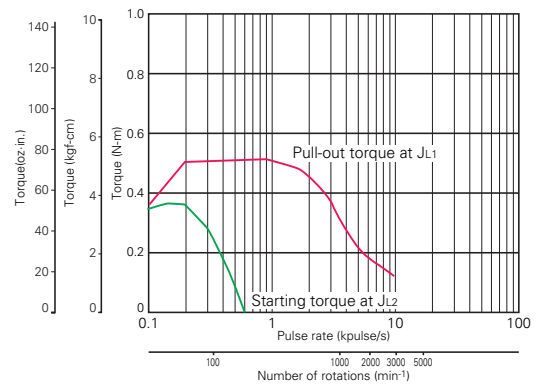

Sanyo constant current circuit

Source voltage: DC24V Operating current: 3A/phase, 2-phase energization (full-step)

J_{L1}=[0.94x10⁻⁴kg·m² (5.14 oz-in²) Use the rubber coupling]

J_{L2}=[0.8x10⁻⁴kg·m² (4.37 oz-in²) Use the direct coupling]

● 103H7121-5640

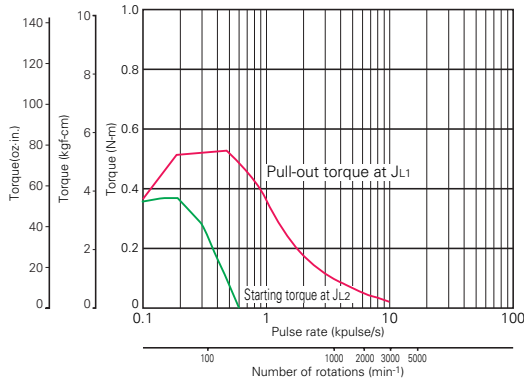

Sanyo constant current circuit

Source voltage: DC24V Operating current: 1A/phase, 2-phase energization (full-step)

J_{L1}=[0.94x10⁻⁴kg·m² (5.14 oz-in²) Use the rubber coupling]

J_{L2}=[0.8x10⁻⁴kg·m² (4.37 oz-in²) Use the direct coupling]

● 103H7121-5740

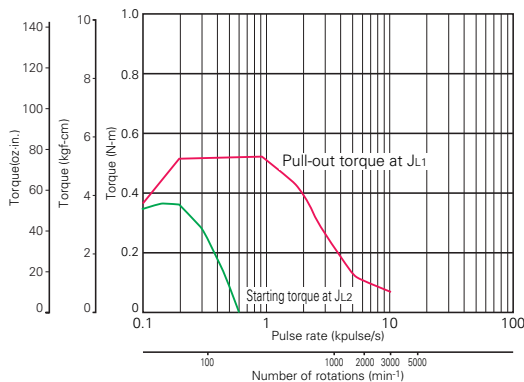

Sanyo constant current circuit

Source voltage: DC24V Operating current: 2A/phase, 2-phase energization (full-step)

J_{L1}=[0.94x10⁻⁴kg·m² (5.14 oz-in²) Use the rubber coupling]

J_{L2}=[0.8x10⁻⁴kg·m² (4.37 oz-in²) Use the direct coupling]

Pulse Rate - Torque Characteristics

● 103H7123-5040

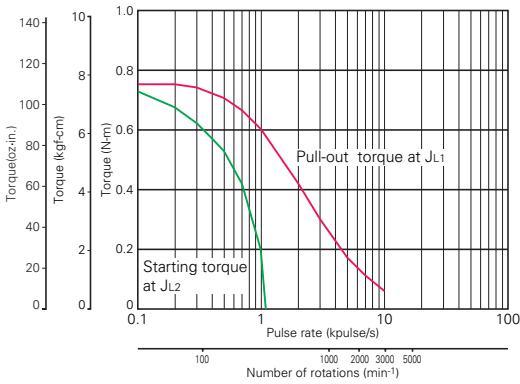

Sanyo constant current circuit
 Source voltage: DC24V Operating current: 2A/phase, 2-phase energization (full-step)
 J_{L1}=[0.94x10⁻⁴kg·m² (5.14 oz-in²) Use the rubber coupling]
 J_{L2}=[0.8x10⁻⁴kg·m² (4.37 oz-in²) Use the direct coupling]

● 103H7123-5840

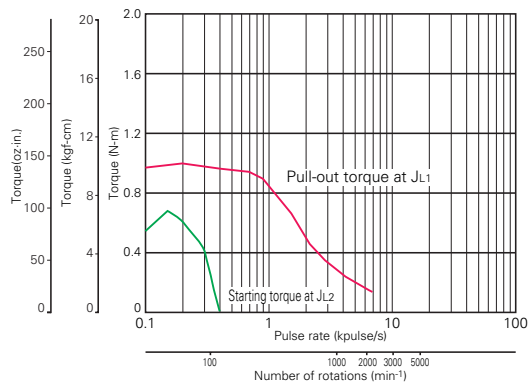

Sanyo constant current circuit
 Source voltage: DC24V Operating current: 3A/phase, 2-phase energization (full-step)
 J_{L1}=[2.6x10⁻⁴kg·m² (14.22 oz-in²) Use the rubber coupling]
 J_{L2}=[2.6x10⁻⁴kg·m² (14.22 oz-in²) Use the direct coupling]

● 103H7123-5640

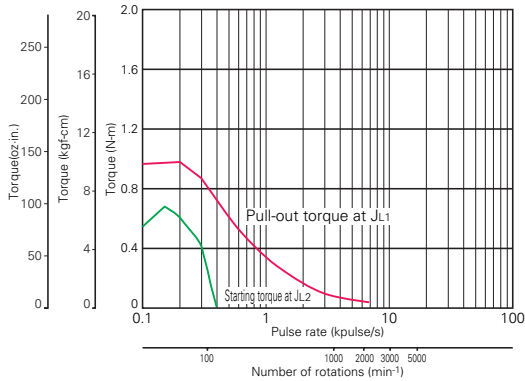

Sanyo constant current circuit
 Source voltage: DC24V Operating current: 1A/phase, 2-phase energization (full-step)
 J_{L1}=[2.6x10⁻⁴kg·m² (14.22 oz-in²) Use the rubber coupling]
 J_{L2}=[2.6x10⁻⁴kg·m² (14.22 oz-in²) Use the direct coupling]

● 103H7123-5740

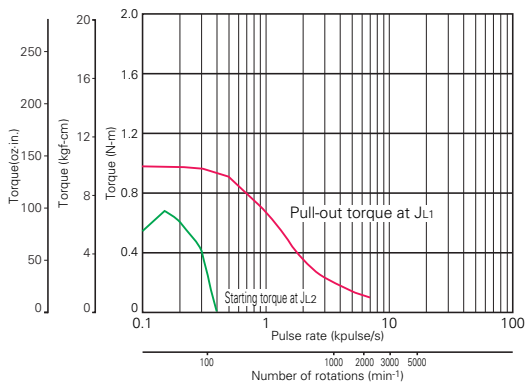

Sanyo constant current circuit
 Source voltage: DC24V Operating current: 2A/phase, 2-phase energization (full-step)
 J_{L1}=[2.6x10⁻⁴kg·m² (14.22 oz-in²) Use the rubber coupling]
 J_{L2}=[2.6x10⁻⁴kg·m² (14.22 oz-in²) Use the direct coupling]

- 35mm(1.38)/1.8"
- 38mm(1.54)/0.9"
- 42mm(1.65)/0.9"
- 28mm(1.10)/1.8"
- 42mm(1.65)/1.8"
- 50mm(1.97)/1.8"
- 56mm(2.20)/1.8"
- 60mm(2.36)/1.8"
- 86mm(3.39)/1.8"
- 106mm(4.17)/1.8"
- 56mm(2.20)/CE
- 86mm(3.39)/CE
- 106mm(4.17)/CE
- 86mm(3.39)/CE
- 106mm(4.17)/CE
- In-vacuum stepping motor
- 2-phase synchronous motor

Pulse Rate - Torque Characteristics

● 103H7126-5040

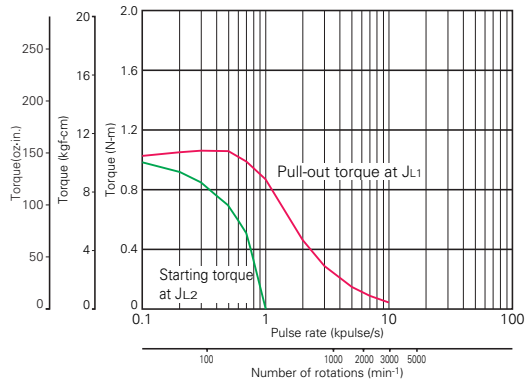

Sanyo constant current circuit

Source voltage: DC24V Operating current: 2A/phase, 2-phase energization (full-step)

$J_{L1}=[2.6 \times 10^{-4} \text{kg} \cdot \text{m}^2 (14.22 \text{ oz} \cdot \text{in}^2)]$ Use the rubber coupling]

$J_{L2}=[2.6 \times 10^{-4} \text{kg} \cdot \text{m}^2 (14.22 \text{ oz} \cdot \text{in}^2)]$ Use the direct coupling]

● 103H7126-5840

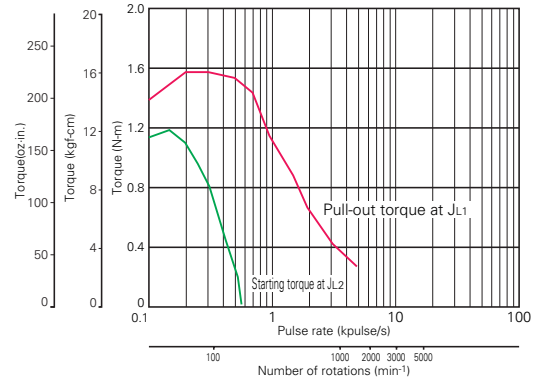

Sanyo constant current circuit

Source voltage: DC24V Operating current: 3A/phase, 2-phase energization (full-step)

$J_{L1}=[2.6 \times 10^{-4} \text{kg} \cdot \text{m}^2 (14.22 \text{ oz} \cdot \text{in}^2)]$ Use the rubber coupling]

$J_{L2}=[2.6 \times 10^{-4} \text{kg} \cdot \text{m}^2 (14.22 \text{ oz} \cdot \text{in}^2)]$ Use the direct coupling]

● 103H7126-5640

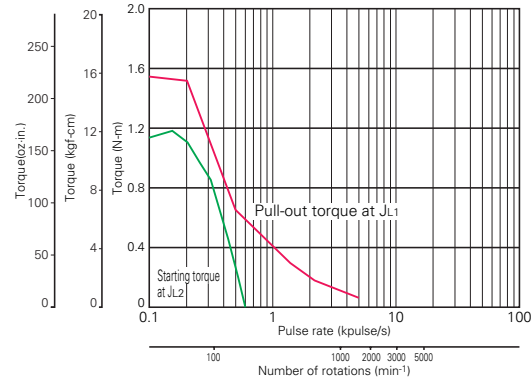

Sanyo constant current circuit

Source voltage: DC24V Operating current: 1A/phase, 2-phase energization (full-step)

$J_{L1}=[2.6 \times 10^{-4} \text{kg} \cdot \text{m}^2 (14.22 \text{ oz} \cdot \text{in}^2)]$ Use the rubber coupling]

$J_{L2}=[2.6 \times 10^{-4} \text{kg} \cdot \text{m}^2 (14.22 \text{ oz} \cdot \text{in}^2)]$ Use the direct coupling]

● 103H7126-5740

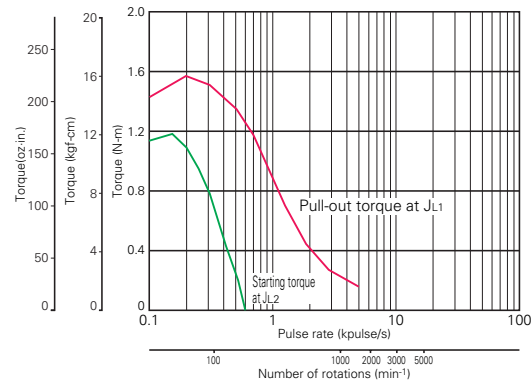

Sanyo constant current circuit

Source voltage: DC24V Operating current: 2A/phase, 2-phase energization (full-step)

$J_{L1}=[2.6 \times 10^{-4} \text{kg} \cdot \text{m}^2 (14.22 \text{ oz} \cdot \text{in}^2)]$ Use the rubber coupling]

$J_{L2}=[2.6 \times 10^{-4} \text{kg} \cdot \text{m}^2 (14.22 \text{ oz} \cdot \text{in}^2)]$ Use the direct coupling]

Pulse Rate - Torque Characteristics

● 103H7128-5640

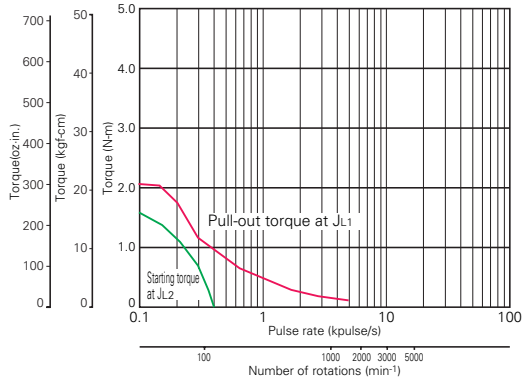

Sanyo constant current circuit
 Source voltage: DC24V Operating current: 1A/phase, 2-phase energization (full-step)
 $J_{L1}=[7.4 \times 10^{-4} \text{kg}\cdot\text{m}^2 (40.46 \text{ oz}\cdot\text{in}^2)]$ Use the rubber coupling]
 $J_{L2}=[7.4 \times 10^{-4} \text{kg}\cdot\text{m}^2 (40.46 \text{ oz}\cdot\text{in}^2)]$ Use the direct coupling]

● 103H7128-5740

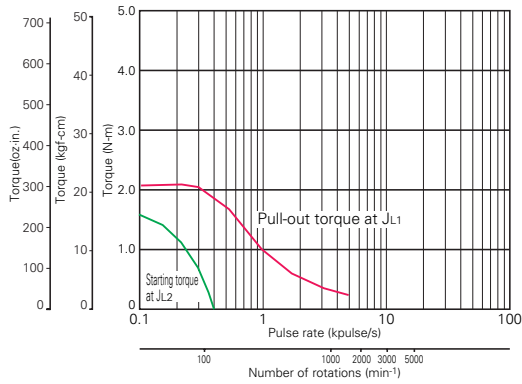

Sanyo constant current circuit
 Source voltage: DC24V Operating current: 2A/phase, 2-phase energization (full-step)
 $J_{L1}=[7.4 \times 10^{-4} \text{kg}\cdot\text{m}^2 (40.46 \text{ oz}\cdot\text{in}^2)]$ Use the rubber coupling]
 $J_{L2}=[7.4 \times 10^{-4} \text{kg}\cdot\text{m}^2 (40.46 \text{ oz}\cdot\text{in}^2)]$ Use the direct coupling]

● 103H7128-5840

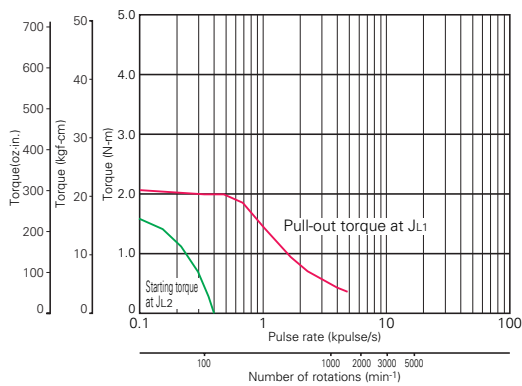

Sanyo constant current circuit
 Source voltage: DC24V Operating current: 3A/phase, 2-phase energization (full-step)
 $J_{L1}=[7.4 \times 10^{-4} \text{kg}\cdot\text{m}^2 (40.46 \text{ oz}\cdot\text{in}^2)]$ Use the rubber coupling]
 $J_{L2}=[7.4 \times 10^{-4} \text{kg}\cdot\text{m}^2 (40.46 \text{ oz}\cdot\text{in}^2)]$ Use the direct coupling]

- 35mm(1.38)/1.8"
- 38mm(1.54)/0.9"
- 42mm(1.65)/0.9"
- 28mm(1.10)/1.8"
- 42mm(1.65)/1.8"
- 50mm(1.97)/1.8"
- 56mm(2.20)/1.8"
- 60mm(2.36)/1.8"
- 86mm(3.39)/1.8"
- 106mm(4.17)/1.8"
- 56mm(2.20)/CE
- 86mm(3.39)/CE
- 106mm(4.17)/CE
- Specifications of 2-phase stepping motor
- In-vacuum stepping motor
- 2-phase synchronous motor



2-phase Stepping Motor

60mm sq. 103H782 □
(2.36inch sq.) 1.8°/step

Recommendable Driver
 Refer to the page 7,17,27 and 45.

Specifications

Unipolar winding

Model		Holding torque at 2-phase energization	Rated current	Resistance	Inductance	Rotor inertia	Mass(Weight)
Single shaft	Double shaft	N·m (oz·in) MIN.	A/phase	Ω/phase	mH/phase	$\times 10^{-4}$ kg·m ² (oz·in ²)	kg(lbs)
103H7821-0140	-0110	0.78(110.5)	1	5.7	8.3	0.275(1.50)	0.6(1.32)
103H7821-0440	-0410	0.78(110.5)	2	1.5	2	0.275(1.50)	0.6(1.32)
103H7821-0740	-0710	0.78(110.5)	3	0.68	0.8	0.275(1.50)	0.6(1.32)
103H7822-0140	-0110	1.17(165.7)	1	6.9	14	0.4(2.19)	0.77(1.70)
103H7822-0440	-0410	1.17(165.7)	2	1.8	3.6	0.4(2.19)	0.77(1.70)
103H7822-0740	-0710	1.17(165.7)	3	0.8	1.38	0.4(2.19)	0.77(1.70)
103H7823-0140	-0110	2.1(297.4)	1	10	21.7	0.84(4.59)	1.34(2.95)
103H7823-0440	-0410	2.1(297.4)	2	2.7	5.6	0.84(4.59)	1.34(2.95)
103H7823-0740	-0710	2.1(297.4)	3	1.25	2.4	0.84(4.59)	1.34(2.95)

Bipolar winding

Model		Holding torque at 2-phase energization	Rated current	Resistance	Inductance	Rotor inertia	Mass(Weight)
Single shaft	Double shaft	N·m (oz·in) MIN.	A/phase	Ω/phase	mH/phase	$\times 10^{-4}$ kg·m ² (oz·in ²)	kg(lbs)
103H7821-1740	-1710	0.88(124.6)	4	0.35	0.8	0.275(1.50)	0.6(1.32)
103H7822-1740	-1710	1.37(194.0)	4	0.43	1.38	0.4(2.19)	0.77(1.70)
103H7823-1740	-1710	2.7(382.3)	4	0.65	2.4	0.84(4.59)	1.34(2.95)

Dimensions [Unit:mm(inch)]

103H7821-0140/0440/0740 (Single shaft)
103H7821-0110/0410/0710 (Double shaft)

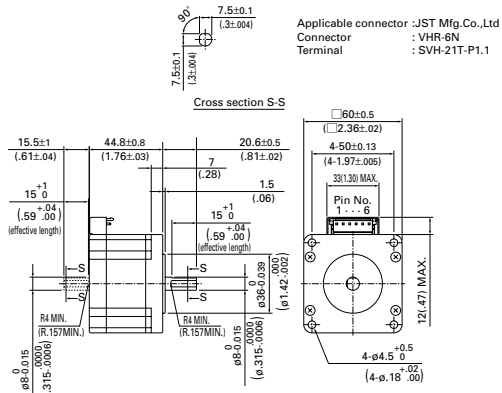

103H7822-0140/0440/0740 (Single shaft)
103H7822-0110/0410/0710 (Double shaft)

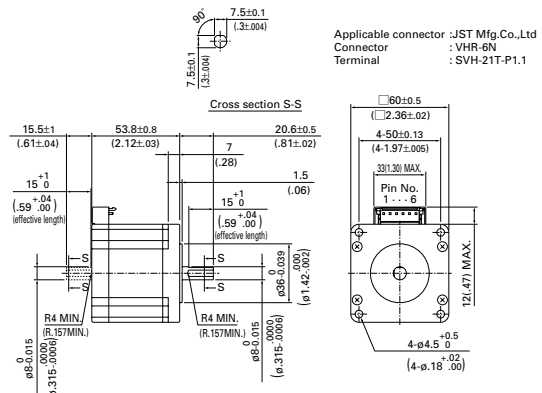

103H7823-0140/0440/0740 (Single shaft)
103H7823-0110/0410/0710 (Double shaft)

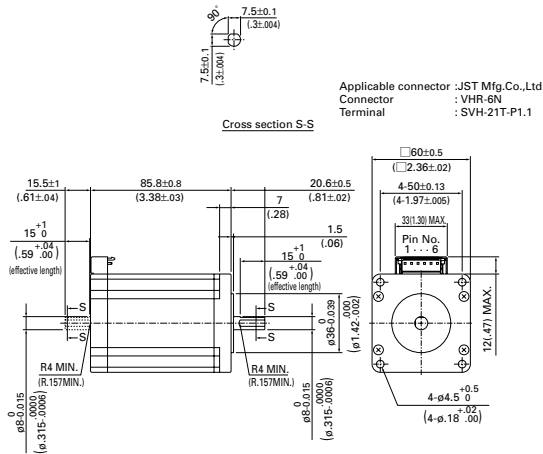

Bipolar winding

103H7821-1740/103H7822-1740/103H7823-1740(Single shaft)
103H7821-1710/103H7822-1710/103H7823-1710(Double shaft)

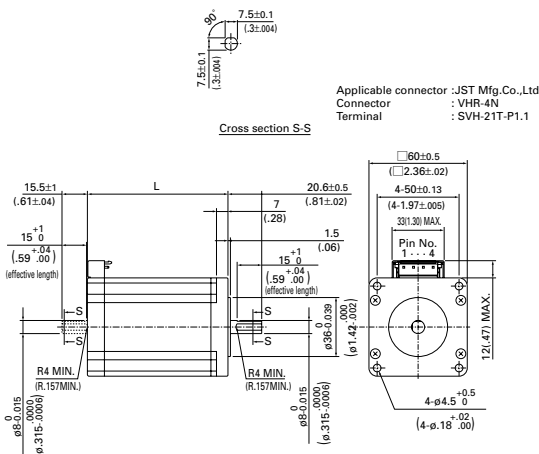

Model	L
103H7821-□□□□	44.8 ± 0.8 (1.76 ± 0.03)
103H7822-□□□□	53.8 ± 0.8 (2.12 ± 0.03)
103H7823-□□□□	85.8 ± 0.8 (3.38 ± 0.03)

35mm(1.38)/1.8"
 38mm(1.54)/0.9"
 42mm(1.65)/0.5"
 28mm(1.10)/1.8"
 42mm(1.65)/1.8"
 50mm(2.20)/1.8"
 56mm(2.20)/1.8"
 60mm(2.36)/1.8"
 86mm(3.39)/1.8"
 106mm(4.17)/1.8"
 56mm(2.20)/CE
 86mm(3.39)/CE
 106mm(4.17)/CE
 Specifications of
 2-phase stepping motor
 In-vacuum
 stepping motor
 2-phase
 synchronous motor

Pulse Rate - Torque Characteristics

● 103H7821-0140

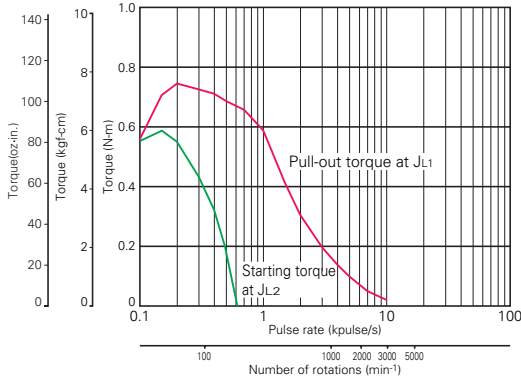

Sanyo constant current circuit
 Source voltage: DC24V Operating current: 1A/phase, 2-phase energization (full-step)
 $J_{L1}=[0.94 \times 10^{-4} \text{kg}\cdot\text{m}^2 (5.14 \text{oz}\cdot\text{in}^2)]$ Use the rubber coupling]
 $J_{L2}=[0.8 \times 10^{-4} \text{kg}\cdot\text{m}^2 (4.37 \text{oz}\cdot\text{in}^2)]$ Use the direct coupling]

● 103H7822-0140

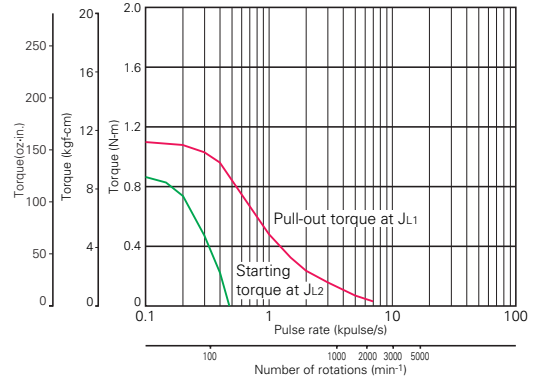

Sanyo constant current circuit
 Source voltage: DC24V Operating current: 1A/phase, 2-phase energization (full-step)
 $J_{L1}=[7.4 \times 10^{-4} \text{kg}\cdot\text{m}^2 (40.46 \text{oz}\cdot\text{in}^2)]$ Use the rubber coupling]
 $J_{L2}=[7.4 \times 10^{-4} \text{kg}\cdot\text{m}^2 (40.46 \text{oz}\cdot\text{in}^2)]$ Use the direct coupling]

● 103H7821-0440

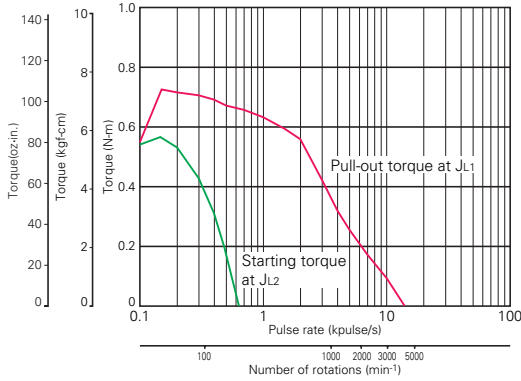

Sanyo constant current circuit
 Source voltage: DC24V Operating current: 2A/phase, 2-phase energization (full-step)
 $J_{L1}=[0.94 \times 10^{-4} \text{kg}\cdot\text{m}^2 (5.14 \text{oz}\cdot\text{in}^2)]$ Use the rubber coupling]
 $J_{L2}=[0.8 \times 10^{-4} \text{kg}\cdot\text{m}^2 (4.37 \text{oz}\cdot\text{in}^2)]$ Use the direct coupling]

● 103H7822-0440

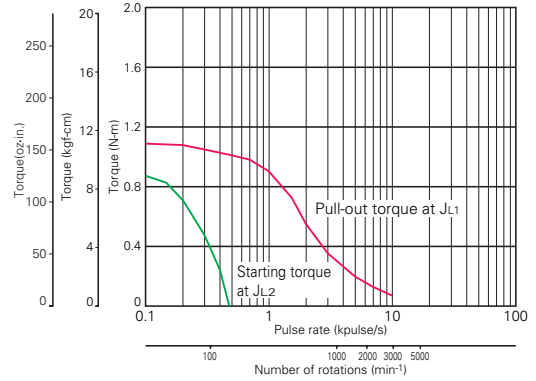

Sanyo constant current circuit
 Source voltage: DC24V Operating current: 2A/phase, 2-phase energization (full-step)
 $J_{L1}=[7.4 \times 10^{-4} \text{kg}\cdot\text{m}^2 (40.46 \text{oz}\cdot\text{in}^2)]$ Use the rubber coupling]
 $J_{L2}=[7.4 \times 10^{-4} \text{kg}\cdot\text{m}^2 (40.46 \text{oz}\cdot\text{in}^2)]$ Use the direct coupling]

● 103H7821-0740

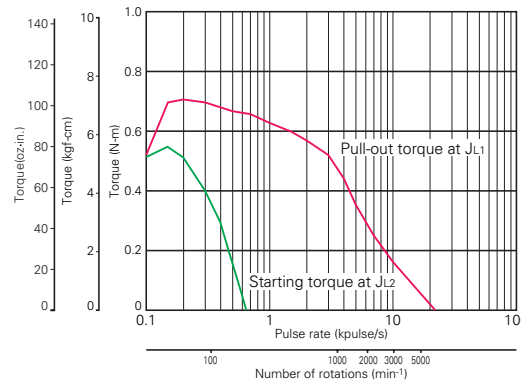

Sanyo constant current circuit
 Source voltage: DC24V Operating current: 3A/phase, 2-phase energization (full-step)
 $J_{L1}=[0.94 \times 10^{-4} \text{kg}\cdot\text{m}^2 (5.14 \text{oz}\cdot\text{in}^2)]$ Use the rubber coupling]
 $J_{L2}=[0.8 \times 10^{-4} \text{kg}\cdot\text{m}^2 (4.37 \text{oz}\cdot\text{in}^2)]$ Use the direct coupling]

● 103H7822-0740

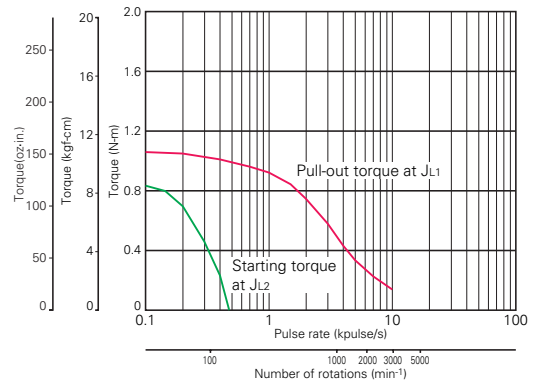

Sanyo constant current circuit
 Source voltage: DC24V Operating current: 3A/phase, 2-phase energization (full-step)
 $J_{L1}=[7.4 \times 10^{-4} \text{kg}\cdot\text{m}^2 (40.46 \text{oz}\cdot\text{in}^2)]$ Use the rubber coupling]
 $J_{L2}=[7.4 \times 10^{-4} \text{kg}\cdot\text{m}^2 (40.46 \text{oz}\cdot\text{in}^2)]$ Use the direct coupling]

Pulse Rate - Torque Characteristics

● 103H7823-0140

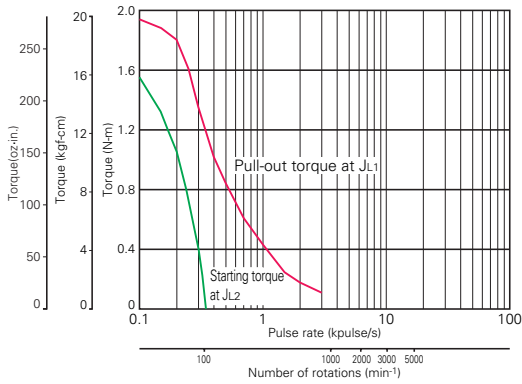

Sanyo constant current circuit
 Source voltage: DC24V Operating current: 1A/phase, 2-phase energization (full-step)
 J_{L1}=[7.4x10⁻⁴kg·m² (40.46 oz-in²) Use the rubber coupling]
 J_{L2}=[7.4x10⁻⁴kg·m² (40.46 oz-in²) Use the direct coupling]

● 103H7821-1740

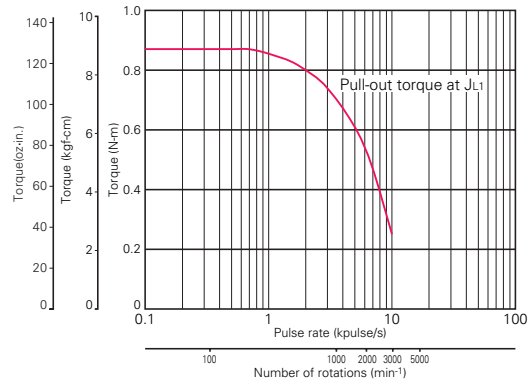

Sanyo constant current circuit
 Source voltage: AC100V Operating current: 4A/phase, 2-phase energization (full-step)
 J_{L1}=[2.6x10⁻⁴kg·m² (14.22 oz-in²) Use the rubber coupling]

● 103H7823-0440

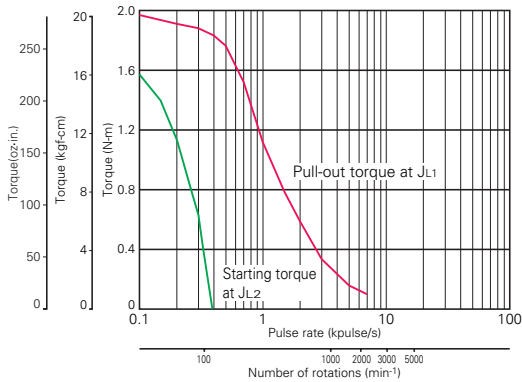

Sanyo constant current circuit
 Source voltage: DC24V Operating current: 2A/phase, 2-phase energization (full-step)
 J_{L1}=[7.4x10⁻⁴kg·m² (40.46 oz-in²) Use the rubber coupling]
 J_{L2}=[7.4x10⁻⁴kg·m² (40.46 oz-in²) Use the direct coupling]

● 103H7822-1740

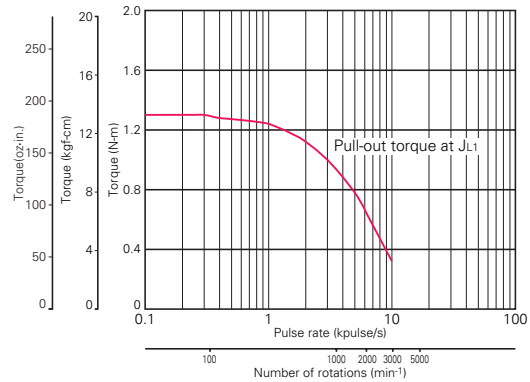

Sanyo constant current circuit
 Source voltage: AC100V Operating current: 4A/phase, 2-phase energization (full-step)
 J_{L1}=[2.6x10⁻⁴kg·m² (14.22 oz-in²) Use the rubber coupling]

● 103H7823-0740

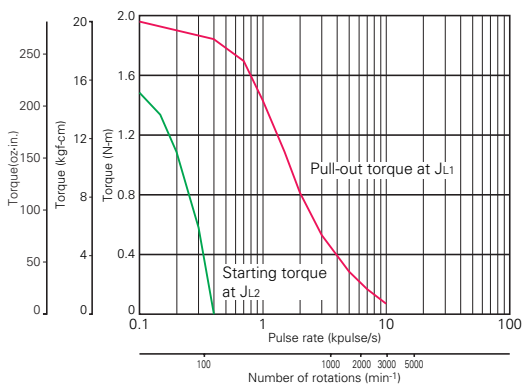

Sanyo constant current circuit
 Source voltage: DC24V Operating current: 3A/phase, 2-phase energization (full-step)
 J_{L1}=[7.4x10⁻⁴kg·m² (40.46 oz-in²) Use the rubber coupling]
 J_{L2}=[7.4x10⁻⁴kg·m² (40.46 oz-in²) Use the direct coupling]

● 103H7823-1740

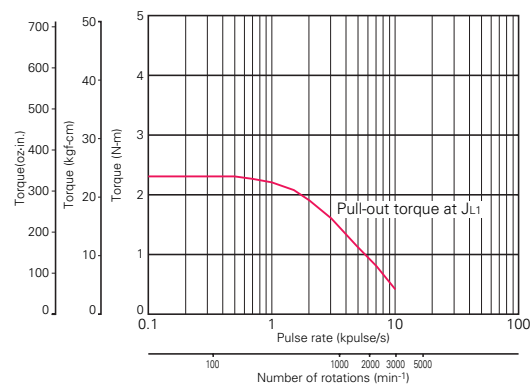

Sanyo constant current circuit
 Source voltage: AC100V Operating current: 4A/phase, 2-phase excitation (full-step)
 J_{L1}=[7.4x10⁻⁴kg·m² (40.46 oz-in²) Use the rubber coupling]

- 35mm(1.38)/1.8"
- 38mm(1.54)/0.9"
- 42mm(1.65)/0.9"
- 28mm(1.10)/1.8"
- 42mm(1.65)/1.8"
- 50mm(1.97)/1.8"
- 56mm(2.20)/1.8"
- 60mm(2.36)/1.8"
- 86mm(3.39)/1.8"
- 106mm(4.17)/1.8"
- 56mm(2.20)/CE
- 86mm(3.39)/CE
- 106mm(4.17)/CE
- Specifications of 2-phase stepping motor
- In-vacuum stepping motor
- 2-phase synchronous motor



2-phase Stepping Motor

86mm cir. 103H822 □
(3.39inch cir.) 1.8°/step

Recommendable Driver
 Refer to the page 7,17,27 and 45.

Specifications

Unipolar winding

Model		Holding torque at 2-phase energization	Rated current	Resistance	Inductance	Rotor inertia	Mass(Weight)
Single shaft	Double shaft	N·m (oz·in) MIN.	A/phase	Ω/phase	mH/phase	$\times 10^{-4}$ kg·m ² (oz·in ²)	kg(lbs)
103H8221-0441	-0411	2.15(304.5)	2	2.5	7.2	1.45(7.93)	1.5(3.31)
103H8221-0941	-0911	2.15(304.5)	4	0.62	1.8	1.45(7.93)	1.5(3.31)
103H8222-0441	-0411	4.13(584.8)	2	4.0	15	2.9(15.86)	2.5(5.51)
103H8222-0941	-0911	4.13(584.8)	4	0.97	3.6	2.9(15.86)	2.5(5.51)
103H8223-0441	-0411	6.27(887.9)	2	5.6	24	4.4(24.06)	3.5(7.72)
103H8223-0941	-0911	6.27(887.9)	4	1.35	5.6	4.4(24.06)	3.5(7.72)

Bipolar winding

Model		Holding torque at 2-phase energization	Rated current	Resistance	Inductance	Rotor inertia	Mass(Weight)
Single shaft	Double shaft	N·m (oz·in) MIN.	A/phase	Ω/phase	mH/phase	$\times 10^{-4}$ kg·m ² (oz·in ²)	kg(lbs)
103H8221-5041	-5011	2.74(388.0)	2	2.3	14	1.45(7.93)	1.5(3.31)
103H8221-5141	-5111	2.74(388.0)	4	0.6	3.5	1.45(7.93)	1.5(3.31)
103H8221-5241	-5211	2.74(388.0)	6	0.3	1.65	1.45(7.93)	1.5(3.31)
103H8222-5041	-5011	5.09(720.8)	2	2.7	23	2.9(15.86)	2.5(5.51)
103H8222-5141	-5111	5.09(720.8)	4	0.7	5.7	2.9(15.86)	2.5(5.51)
103H8222-5241	-5211	5.09(720.8)	6	0.35	2.7	2.9(15.86)	2.5(5.51)
103H8223-5041	-5011	7.44(1053.6)	2	3.6	32.5	4.4(24.06)	3.5(7.72)
103H8223-5141	-5111	7.44(1053.6)	4	0.9	8.1	4.4(24.06)	3.5(7.72)
103H8223-5241	-5211	7.44(1053.6)	6	0.45	3.4	4.4(24.06)	3.5(7.72)

Dimensions [Unit:mm(inch)]

103H8221-0441/0941 (Single shaft)
103H8221-0411/0911 (Double shaft)

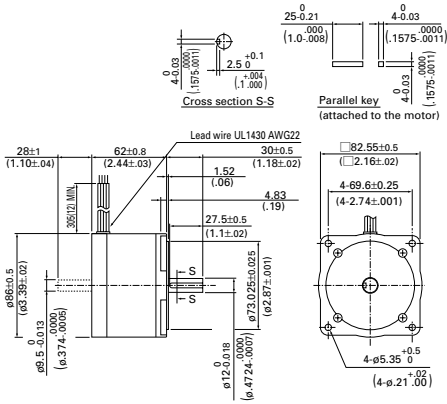

103H8222-0441/0941 (Single shaft)
103H8222-0411/0911 (Double shaft)

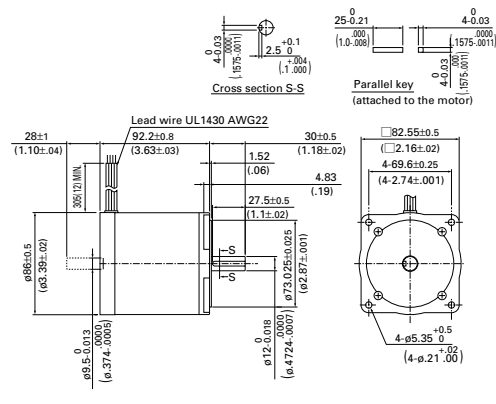

103H8223-0441/0941 (Single shaft)
103H8223-0411/0911 (Double shaft)

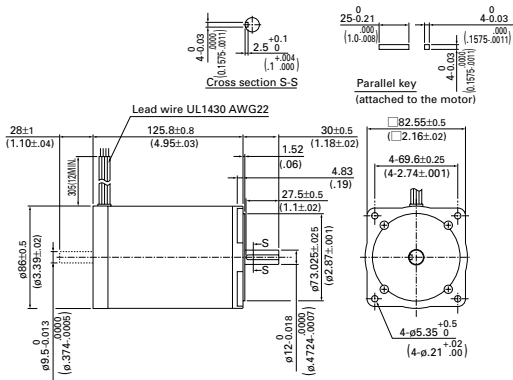

Bipolar winding

103H8221/103H8222/103H8223-5 □ 41 (Single shaft)
103H8221/103H8222/103H8223-5 □ 11 (Double shaft)

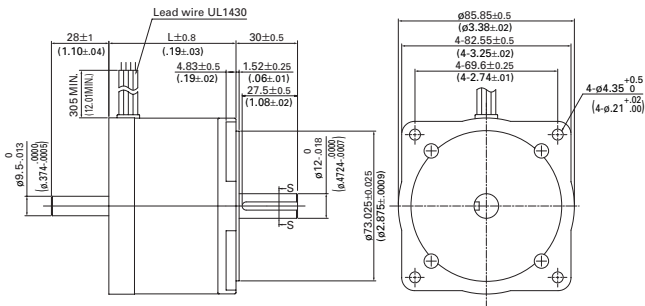

Model	AWG	L
103H8221-50 □ 1	22	62 (2.44)
103H8221-51 □ 1		
103H8221-52 □ 1		
103H8222-50 □ 1	18	92.2 (3.63)
103H8222-51 □ 1		
103H8222-52 □ 1	22	125.8 (4.95)
103H8223-50 □ 1		
103H8223-51 □ 1		
103H8223-52 □ 1	18	

ø35mm(1.38)/1.8"
 ø38mm(1.54)/0.9"
 ø42mm(1.65)/0.9"
 ø28mm(1.10)/1.8"
 ø28mm(1.10)/1.8"
 ø28mm(1.10)/1.8"
 ø50mm(1.97)/1.8"
 ø56mm(2.20)/1.8"
 ø60mm(2.36)/1.8"
 ø86mm(3.39)/1.8"
 ø106mm(4.17)/1.8"
 ø106mm(4.17)/1.8"
 ø106mm(4.17)/1.8"
 ø86mm(3.39)/1.8"
 ø106mm(4.17)/1.8"
 ø86mm(3.39)/1.8"
 ø106mm(4.17)/1.8"
 ø106mm(4.17)/1.8"

Specifications of 2-phase stepping motor
 In-vacuum stepping motor
 2-phase synchronous motor

Pulse Rate - Torque Characteristics

● 103H8221-0441

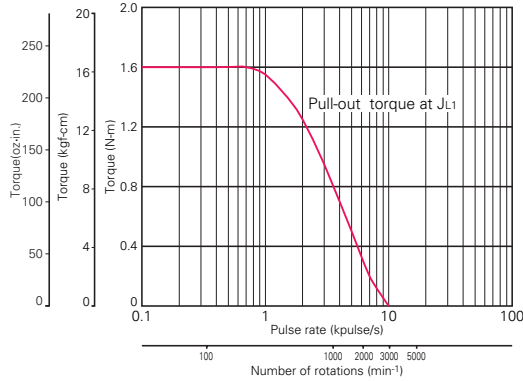

Sanyo constant current circuit
 Source voltage: AC100V Operating current: 2A/phase, 2-phase energization (full-step)
 $J_{L1}=[7.4 \times 10^{-4} \text{kg}\cdot\text{m}^2 (40.46 \text{ oz}\cdot\text{in}^2)]$ Use the rubber coupling]

● 103H8221-0941

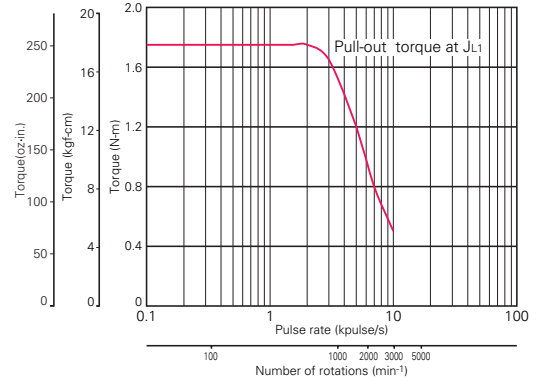

Sanyo constant current circuit
 Source voltage: AC100V Operating current: 4A/phase, 2-phase energization (full-step)
 $J_{L1}=[7.4 \times 10^{-4} \text{kg}\cdot\text{m}^2 (40.46 \text{ oz}\cdot\text{in}^2)]$ Use the rubber coupling]

● 103H8222-0441

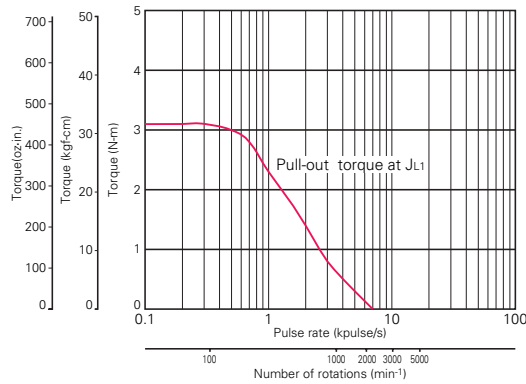

Sanyo constant current circuit
 Source voltage: AC100V Operating current: 2A/phase, 2-phase energization (full-step)
 $J_{L1}=[15.3 \times 10^{-4} \text{kg}\cdot\text{m}^2 (83.65 \text{ oz}\cdot\text{in}^2)]$ Use the rubber coupling]

● 103H8222-0941

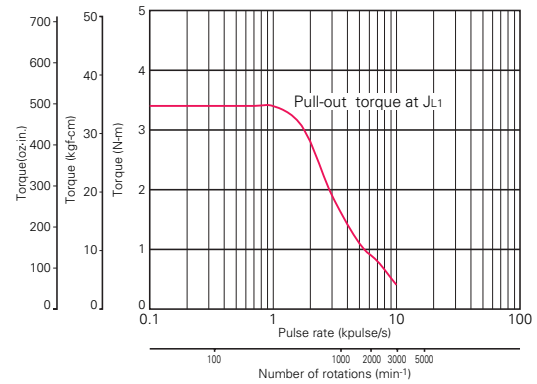

Sanyo constant current circuit
 Source voltage: AC100V Operating current: 4A/phase, 2-phase energization (full-step)
 $J_{L1}=[15.3 \times 10^{-4} \text{kg}\cdot\text{m}^2 (83.65 \text{ oz}\cdot\text{in}^2)]$ Use the rubber coupling]

● 103H8223-0441

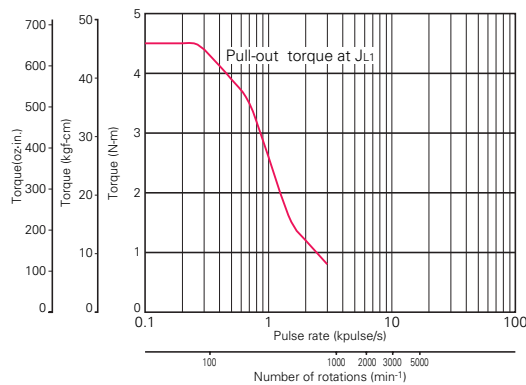

Sanyo constant current circuit
 Source voltage: AC100V Operating current: 2A/phase, 2-phase energization (full-step)
 $J_{L1}=[15.3 \times 10^{-4} \text{kg}\cdot\text{m}^2 (83.65 \text{ oz}\cdot\text{in}^2)]$ Use the rubber coupling]

● 103H8223-0941

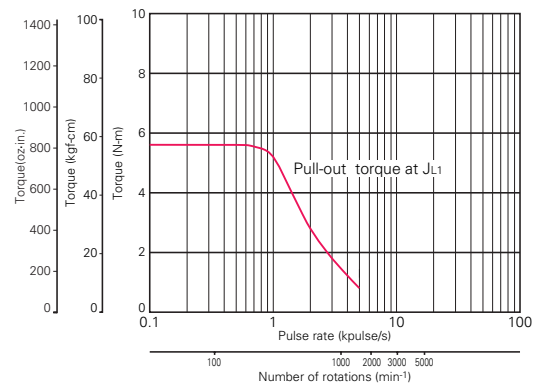

Sanyo constant current circuit
 Source voltage: AC100V Operating current: 4A/phase, 2-phase energization (full-step)
 $J_{L1}=[15.3 \times 10^{-4} \text{kg}\cdot\text{m}^2 (83.65 \text{ oz}\cdot\text{in}^2)]$ Use the rubber coupling]

Pulse Rate - Torque Characteristics

103H8221-5041

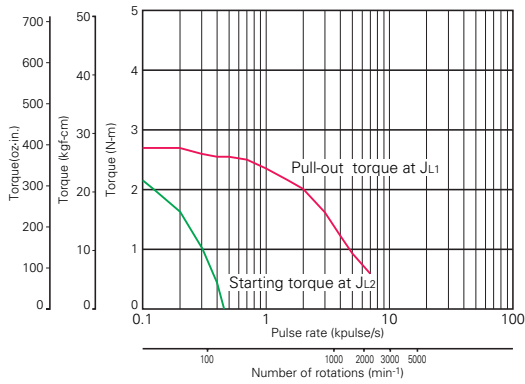

Sanyo constant current circuit
 Source voltage: AC100V Operating current: 2A/phase, 2-phase energization (full-step)
 $J_{L1}=[7.4 \times 10^{-4} \text{kg}\cdot\text{m}^2 (40.46 \text{ oz}\cdot\text{in}^2)]$ Use the rubber coupling)
 $J_{L2}=[7.4 \times 10^{-4} \text{kg}\cdot\text{m}^2 (40.46 \text{ oz}\cdot\text{in}^2)]$ Use the direct coupling)

103H8221-5141

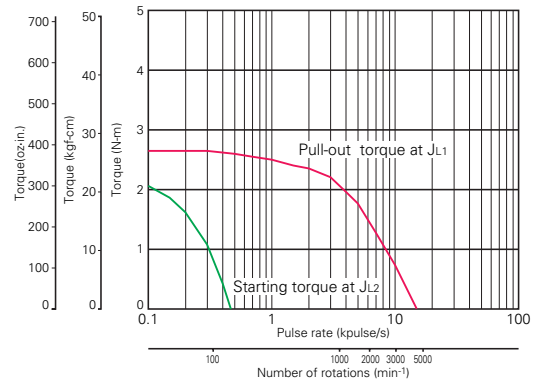

Sanyo constant current circuit
 Source voltage: AC100V Operating current: 4A/phase, 2-phase energization (full-step)
 $J_{L1}=[7.4 \times 10^{-4} \text{kg}\cdot\text{m}^2 (40.46 \text{ oz}\cdot\text{in}^2)]$ Use the rubber coupling)
 $J_{L2}=[7.4 \times 10^{-4} \text{kg}\cdot\text{m}^2 (40.46 \text{ oz}\cdot\text{in}^2)]$ Use the direct coupling)

103H8221-5241

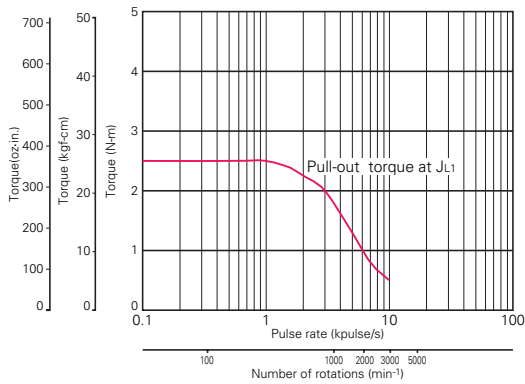

Sanyo constant current circuit
 Source voltage: AC100V Operating current: 6A/phase, 2-phase energization (full-step)
 $J_{L1}=[15.3 \times 10^{-4} \text{kg}\cdot\text{m}^2 (83.65 \text{ oz}\cdot\text{in}^2)]$ Use the rubber coupling)

103H8222-5041

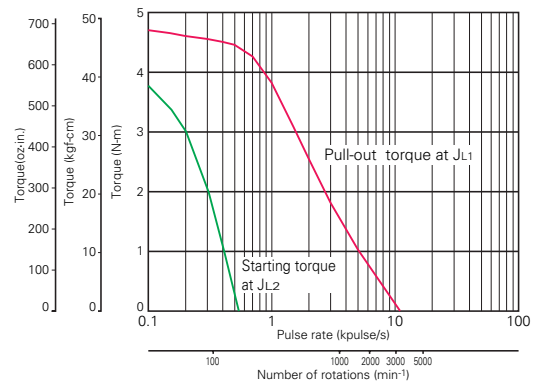

Sanyo constant current circuit
 Source voltage: AC100V Operating current: 2A/phase, 2-phase energization (full-step)
 $J_{L1}=[15.3 \times 10^{-4} \text{kg}\cdot\text{m}^2 (83.65 \text{ oz}\cdot\text{in}^2)]$ Use the rubber coupling)
 $J_{L2}=[15.3 \times 10^{-4} \text{kg}\cdot\text{m}^2 (83.65 \text{ oz}\cdot\text{in}^2)]$ Use the direct coupling)

103H8222-5141

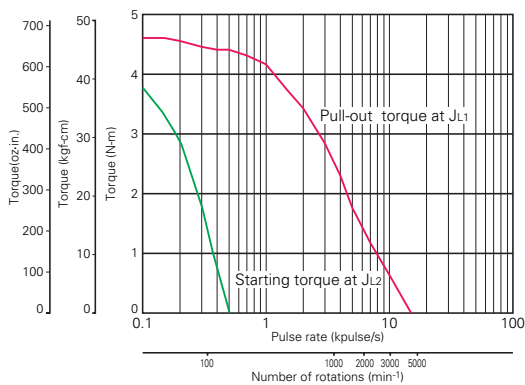

Sanyo constant current circuit
 Source voltage: AC100V Operating current: 4A/phase, 2-phase energization (full-step)
 $J_{L1}=[15.3 \times 10^{-4} \text{kg}\cdot\text{m}^2 (83.65 \text{ oz}\cdot\text{in}^2)]$ Use the rubber coupling)
 $J_{L2}=[15.3 \times 10^{-4} \text{kg}\cdot\text{m}^2 (83.65 \text{ oz}\cdot\text{in}^2)]$ Use the direct coupling)

103H8222-5241

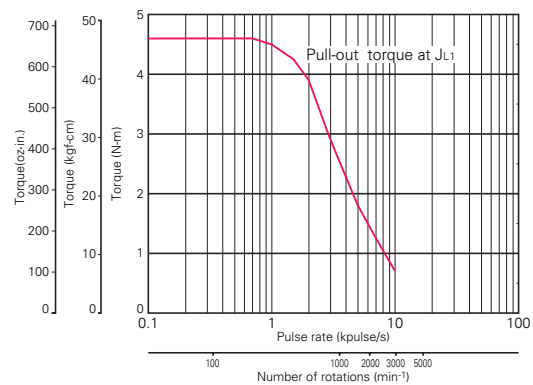

Sanyo constant current circuit
 Source voltage: AC100V Operating current: 6A/phase, 2-phase energization (full-step)
 $J_{L1}=[15.3 \times 10^{-4} \text{kg}\cdot\text{m}^2 (83.65 \text{ oz}\cdot\text{in}^2)]$ Use the rubber coupling)

Specifications of 2-phase synchronous motor
 In-vacuum stepping motor
 2-phase synchronous motor
 ø106mm(4.17)/CE ø86mm(3.39)/CE ø106mm(4.17)/1.8 ø86mm(3.39)/1.8
 ø60mm(2.36)/1.8 ø56mm(2.20)/1.8 ø50mm(1.97)/1.8
 ø42mm(1.65)/1.8 ø28mm(1.10)/1.8 ø38mm(1.54)/0.9 ø35mm(1.38)/1.8

Pulse Rate - Torque Characteristics

● 103H8223-5041

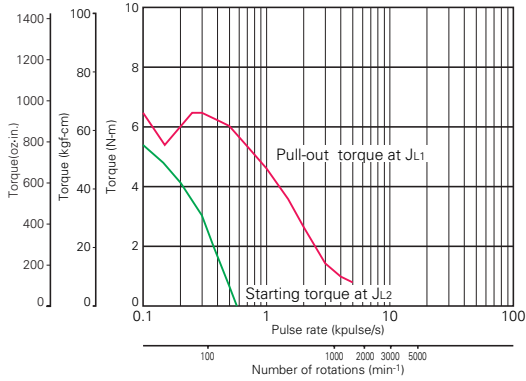

Sanyo constant current circuit

Source voltage: AC100V Operating current: 2A/phase, 2-phase energization (full-step)

$J_{L1}=[15.3 \times 10^{-4} \text{kg}\cdot\text{m}^2 (83.65 \text{oz}\cdot\text{in}^2)]$ Use the rubber coupling]

$J_{L2}=[15.3 \times 10^{-4} \text{kg}\cdot\text{m}^2 (83.65 \text{oz}\cdot\text{in}^2)]$ Use the direct coupling]

● 103H8223-5141

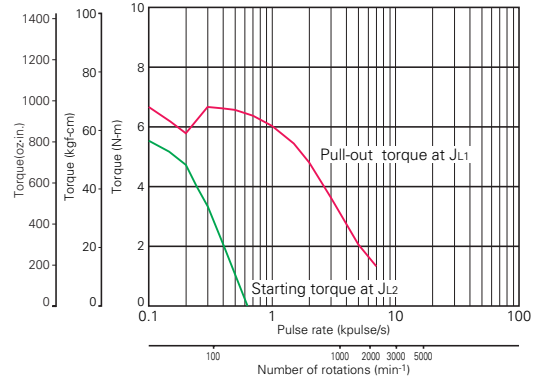

Sanyo constant current circuit

Source voltage: AC100V Operating current: 4A/phase, 2-phase energization (full-step)

$J_{L1}=[15.3 \times 10^{-4} \text{kg}\cdot\text{m}^2 (83.65 \text{oz}\cdot\text{in}^2)]$ Use the rubber coupling]

$J_{L2}=[15.3 \times 10^{-4} \text{kg}\cdot\text{m}^2 (83.65 \text{oz}\cdot\text{in}^2)]$ Use the direct coupling]

● 103H8223-5241

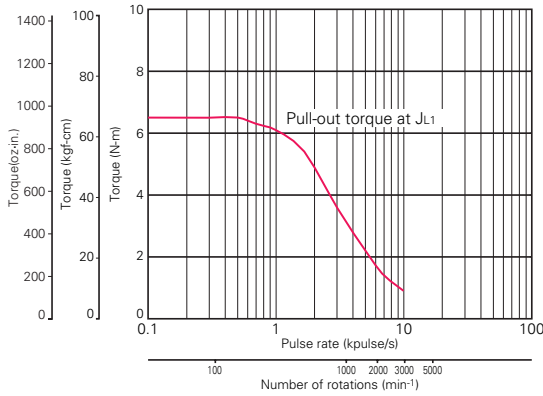

Sanyo constant current circuit

Source voltage: AC100V Operating current: 6A/phase, 2-phase energization (full-step)

$J_{L1}=[15.3 \times 10^{-4} \text{kg}\cdot\text{m}^2 (83.65 \text{oz}\cdot\text{in}^2)]$ Use the rubber coupling]



2-phase Stepping Motor

106mm cir. 103H8922 □
(4.17inch cir.) 1.8°/step

Recommendable Driver
 Refer to the page 7 and 17.

Specifications

Unipolar winding

Model		Holding torque at 2-phase energization	Rated current	Resistance	Inductance	Rotor inertia	Mass(Weight)
Single shaft	Double shaft	N·m (oz·in) MIN.	A/phase	Ω/phase	mH/phase	$\times 10^{-4}$ kg·m ² (oz·in ²)	kg(lbs)
103H89222-0941	-0911	10.8(1529.4)	4	0.98	6.3	14.6(79.83)	7.5(16.53)
103H89223-0941	-0911	15.5(2194.9)	4	1.4	9.7	22(120.28)	10.5(23.15)

Bipolar winding

Model		Holding torque at 2-phase energization	Rated current	Resistance	Inductance	Rotor inertia	Mass(Weight)
Single shaft	Double shaft	N·m (oz·in) MIN.	A/phase	Ω/phase	mH/phase	$\times 10^{-4}$ kg·m ² (oz·in ²)	kg(lbs)
103H89222-5241	-5211	13.2(1869.2)	6	0.45	5.4	14.6(79.83)	7.5(16.53)
103H89223-5241	-5211	19(2690.5)	6	0.63	8	22(120.28)	10.5(23.15)

Dimensions [Unit:mm(inch)]

103H89222-0941/5241 (Single shaft)
 103H89222-0911/5211 (Double shaft)

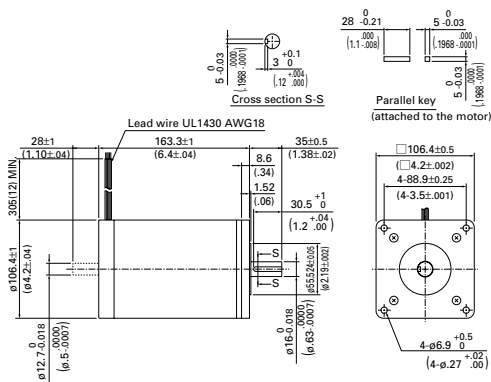

103H89223-0941/5241 (Single shaft)
 103H89223-0911/5211 (Double shaft)

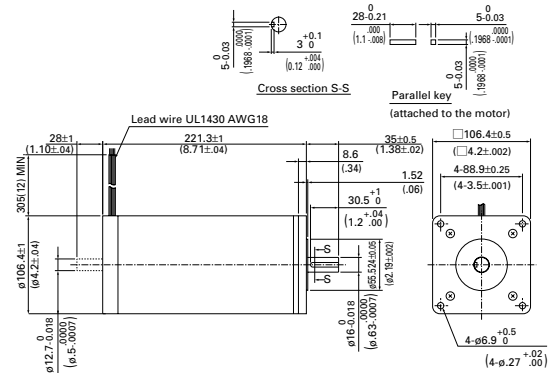

Pulse Rate - Torque Characteristics

● 103H89222-5241

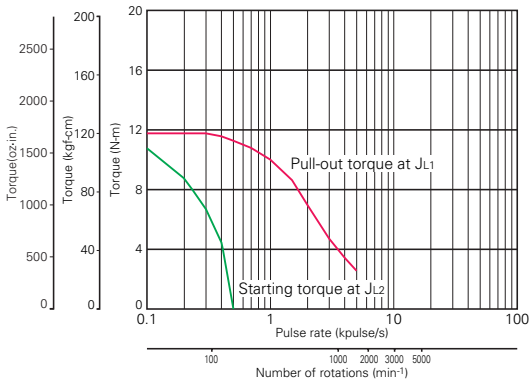

Sanyo constant current circuit
 Source voltage: AC100V Operating current: 6A/phase, 2-phase energization (full-step)
 $J_{L1}=[43 \times 10^{-4} \text{kg} \cdot \text{m}^2 (235.10 \text{ oz} \cdot \text{in}^2)]$ Use the rubber coupling]
 $J_{L2}=[43 \times 10^{-4} \text{kg} \cdot \text{m}^2 (235.10 \text{ oz} \cdot \text{in}^2)]$ Use the direct coupling]

● 103H89223-5241

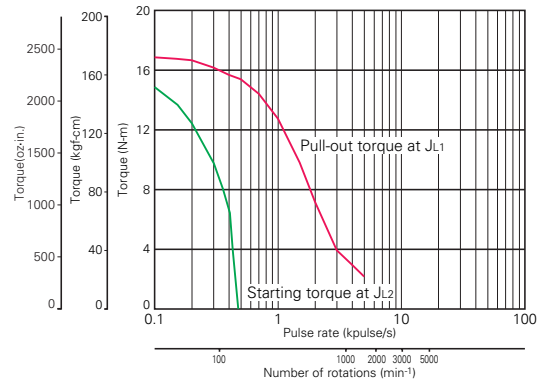

Sanyo constant current circuit
 Source voltage: AC100V Operating current: 6A/phase, 2-phase energization (full-step)
 $J_{L1}=[43 \times 10^{-4} \text{kg} \cdot \text{m}^2 (235.10 \text{ oz} \cdot \text{in}^2)]$ Use the rubber coupling]
 $J_{L2}=[43 \times 10^{-4} \text{kg} \cdot \text{m}^2 (235.10 \text{ oz} \cdot \text{in}^2)]$ Use the direct coupling]

● 103H89222-0941

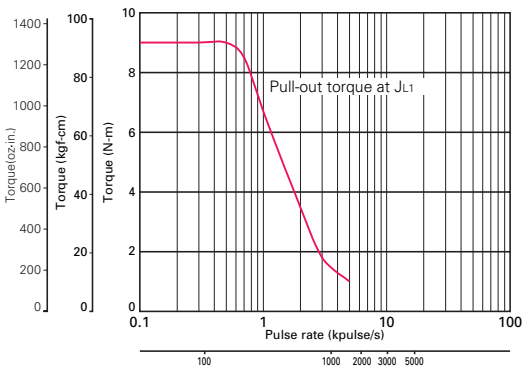

Sanyo constant current circuit
 Source voltage: AC100V Operating current: 4A/phase, 2-phase energization (full-step)
 $J_{L1}=[43 \times 10^{-4} \text{kg} \cdot \text{m}^2 (235.10 \text{ oz} \cdot \text{in}^2)]$ Use the rubber coupling]

● 103H89223-0941

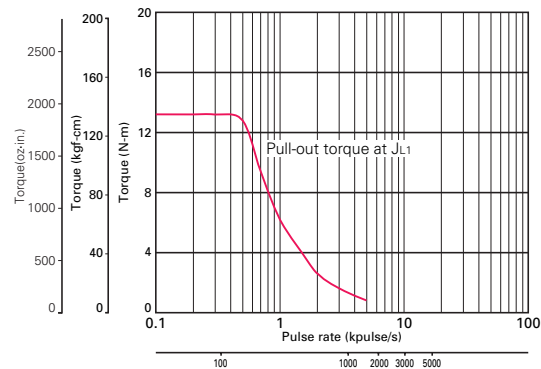

Sanyo constant current circuit
 Source voltage: AC100V Operating current: 4A/phase, 2-phase energization (full-step)
 $J_{L1}=[43 \times 10^{-4} \text{kg} \cdot \text{m}^2 (235.10 \text{ oz} \cdot \text{in}^2)]$ Use the rubber coupling]

- 35mm(1.38)/1.8"
- 38mm(1.54)/0.9"
- 42mm(1.65)/0.9"
- 28mm(1.10)/1.8"
- 42mm(1.65)/1.8"
- 50mm(1.97)/1.8"
- 56mm(2.20)/1.8"
- 60mm(2.36)/1.8"
- 86mm(3.39)/1.8"
- 106mm(4.17)/1.8"
- 56mm(2.20)/CE
- 86mm(3.39)/CE
- 106mm(4.17)/CE
- Specifications of 2-phase stepping motor
- In-vacuum stepping motor
- 2-phase synchronous motor



2-phase Stepping Motor

56mm sq.
(2.20inch sq.)

103H712 □
Conforming to the CE marking
1.8°/step



Specifications

Unipolar winding

Model	Holding torque at 2-phase energization	Rated current	Resistance	Inductance	Rotor inertia	Mass(Weight)	
Single shaft	Double shaft	N-m(oz-in) MIN.	A/phase	Ω/phase	mH/phase	x10 ⁻⁴ kg·m ² (oz·in ²)	kg(lbs)
103H7121-6140	-6110	0.39(55.2)	1	4.8	8	0.1(0.55)	0.47(1.04)
103H7121-6740	-6710	0.39(55.2)	3	0.6	0.8	0.1(0.55)	0.47(1.04)
103H7123-6140	-6110	0.83(117.5)	1	6.7	15	0.21(1.15)	0.65(1.43)
103H7123-6740	-6710	0.78(110.5)	3	0.77	1.58	0.21(1.15)	0.65(1.43)
103H7126-6140	-6110	1.27(179.8)	1	8.6	19	0.36(1.97)	0.98(2.16)
103H7126-6740	-6710	1.27(179.8)	3	0.9	2.2	0.36(1.97)	0.98(2.16)

Dimensions [Unit:mm(inch)]

103H7121-6140/6740 (Single shaft) 103H7121-6110/6710 (Double shaft)

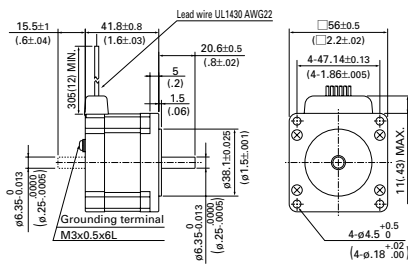

103H7123-6140/6740 (Single shaft) 103H7123-6110/6710 (Double shaft)

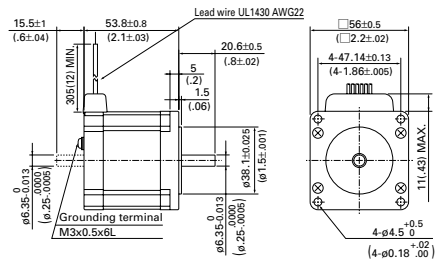

103H7126-6140/6740 (Single shaft) 103H7126-6110/6710 (Double shaft)

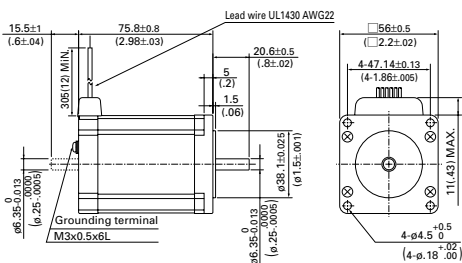

Pulse Rate - Torque Characteristics

● 103H7121-6140

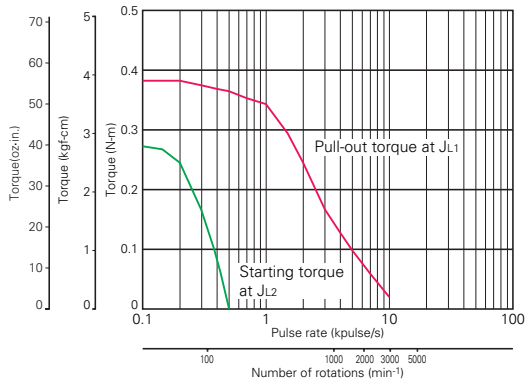

Sanyo constant current circuit
 Source voltage: DC24V Operating current: 1A/phase, 2-phase energization (full-step)
 J_{L1}=[0.94x10⁻⁴kg·m² (5.14 oz-in²) Use the rubber coupling]
 J_{L2}=[0.8x10⁻⁴kg·m² (4.37 oz-in²) Use the direct coupling]

● 103H7121-6740

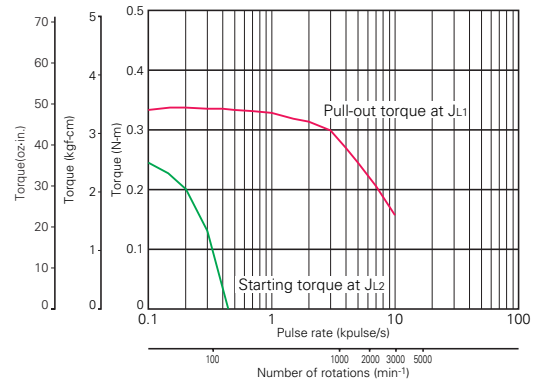

Sanyo constant current circuit
 Source voltage: DC24V Operating current: 3A/phase, 2-phase energization (full-step)
 J_{L1}=[0.94x10⁻⁴kg·m² (5.14 oz-in²) Use the rubber coupling]
 J_{L2}=[0.8x10⁻⁴kg·m² (4.37 oz-in²) Use the direct coupling]

● 103H7123-6140

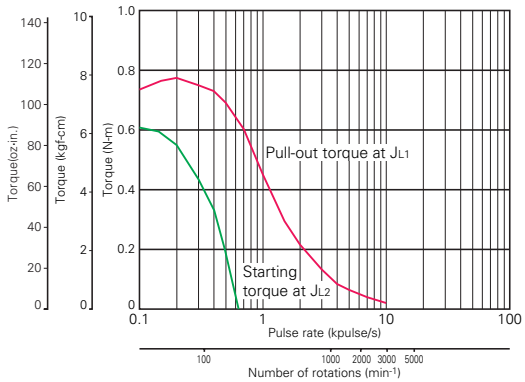

Sanyo constant current circuit
 Source voltage: DC24V Operating current: 1A/phase, 2-phase energization (full-step)
 J_{L1}=[0.94x10⁻⁴kg·m² (5.14 oz-in²) Use the rubber coupling]
 J_{L2}=[0.8x10⁻⁴kg·m² (4.37 oz-in²) Use the direct coupling]

● 103H7123-6740

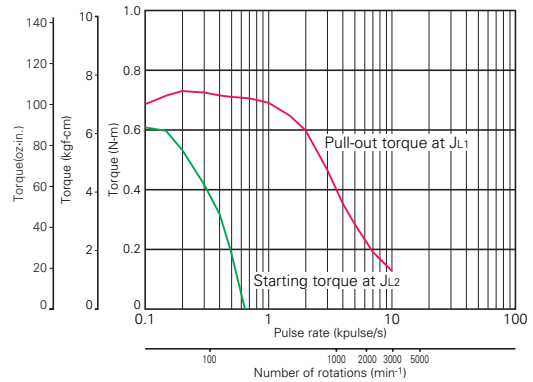

Sanyo constant current circuit
 Source voltage: DC24V Operating current: 3A/phase, 2-phase energization (full-step)
 J_{L1}=[0.94x10⁻⁴kg·m² (5.14 oz-in²) Use the rubber coupling]
 J_{L2}=[0.8x10⁻⁴kg·m² (4.37 oz-in²) Use the direct coupling]

● 103H7126-6140

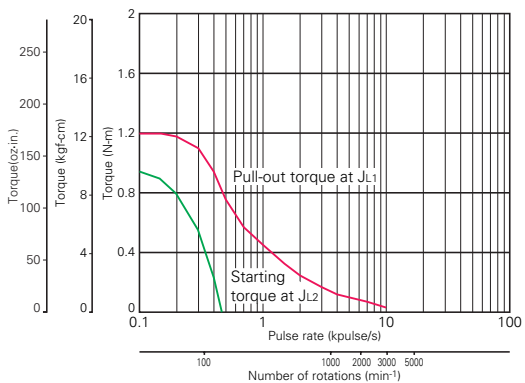

Sanyo constant current circuit
 Source voltage: DC24V Operating current: 1A/phase, 2-phase energization (full-step)
 J_{L1}=[2.6x10⁻⁴kg·m² (14.22 oz-in²) Use the rubber coupling]
 J_{L2}=[2.6x10⁻⁴kg·m² (14.22 oz-in²) Use the direct coupling]

● 103H7126-6740

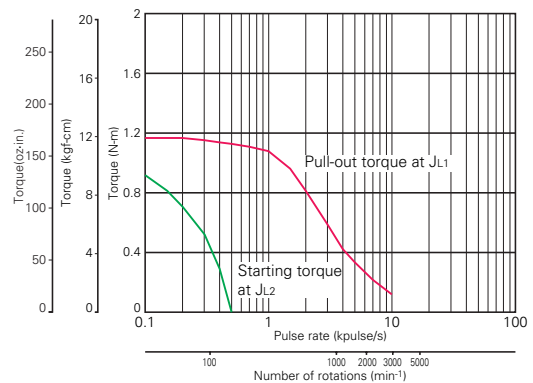

Sanyo constant current circuit
 Source voltage: DC24V Operating current: 3A/phase, 2-phase energization (full-step)
 J_{L1}=[2.6x10⁻⁴kg·m² (14.22 oz-in²) Use the rubber coupling]
 J_{L2}=[2.6x10⁻⁴kg·m² (14.22 oz-in²) Use the direct coupling]

Specifications of 2-phase synchronous motor

- 35mm(1.38)/1.8"
- 38mm(1.54)/0.9"
- 42mm(1.65)/0.9"
- 28mm(1.10)/1.8"
- 42mm(1.65)/1.8"
- 50mm(1.97)/1.8"
- 56mm(2.20)/1.8"
- 60mm(2.36)/1.8"
- 86mm(3.39)/1.8"
- 106mm(4.17)/1.8"
- 56mm(2.20)/CE
- 86mm(3.39)/CE
- 106mm(4.17)/CE



2-phase Stepping Motor

86mm cir.
(3.39inch cir.)

103H822 □
Conforming to the CE marking
1.8°/step



Specifications

Bipolar winding

Model		Holding torque at 2-phase energization	Rated current	Resistance	Inductance	Rotor inertia	Mass(Weight)
Single shaft	Double shaft	N·m(oz·in) MIN.	A/phase	Ω/phase	mH/phase	x10 ⁻⁴ kg·m ² (oz·in ²)	kg(lbs)
103H8221-6240	-6210	2.74(388.0)	6	0.3	1.65	1.45(7.93)	1.5(3.31)
103H8222-6340	-6310	5.09(720.8)	6	0.35	2.7	2.9(15.86)	2.5(5.51)
103H8223-6340	-6310	7.44(1053.6)	6	0.45	3.4	4.4(24.06)	3.5(7.72)

Dimensions [Unit:mm(inch)]

103H8221-6240 (Single shaft)
103H8221-6210 (Double shaft)

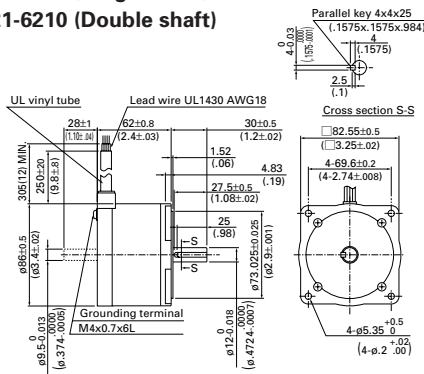

103H8222-6340 (Single shaft)
103H8222-6310 (Double shaft)

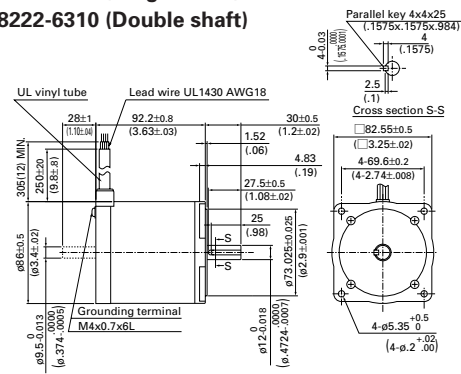

103H8223-6340 (Single shaft)
103H8223-6310 (Double shaft)

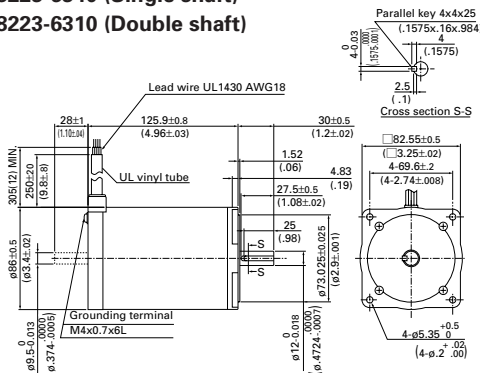

Pulse Rate - Torque Characteristics

● 103H8221-6240

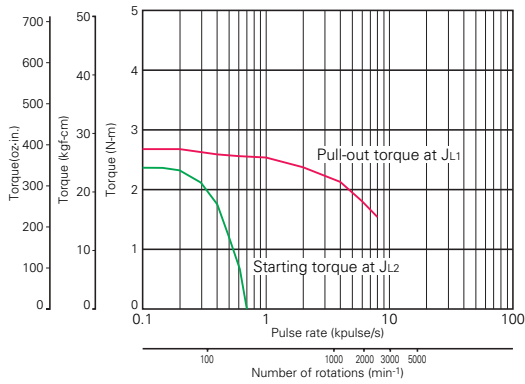

Sanyo constant current circuit

Source voltage: AC100V Operating current: 6A/phase, 2-phase energization (full-step)

J_{L1}=[7.4x10⁻⁴kg·m² (40.46 oz-in²) Use the rubber coupling]

J_{L2}=[7.4x10⁻⁴kg·m² (40.46 oz-in²) Use the direct coupling]

● 103H8222-6340

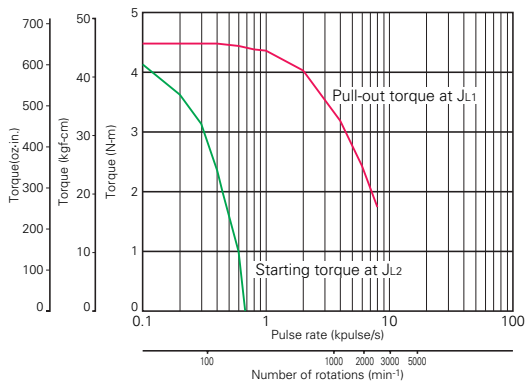

Sanyo constant current circuit

Source voltage: AC100V Operating current: 6A/phase, 2-phase energization (full-step)

J_{L1}=[15.3x10⁻⁴kg·m² (83.65 oz-in²) Use the rubber coupling]

J_{L2}=[15.3x10⁻⁴kg·m² (83.65 oz-in²) Use the direct coupling]

● 103H8223-6340

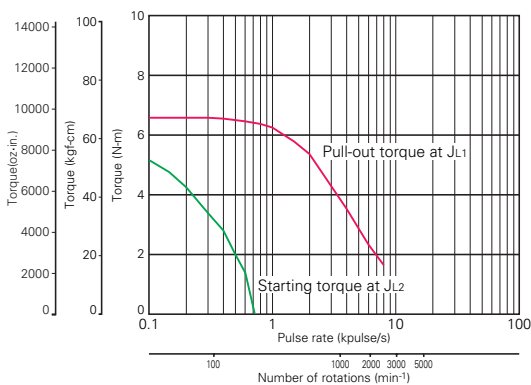

Sanyo constant current circuit

Source voltage: AC100V Winding current: 6A/phase, 2-phase energization (full-step)

J_{L1}=[43x10⁻⁴kg·m² (235.10 oz-in²) Use the rubber coupling]

J_{L2}=[43x10⁻⁴kg·m² (235.10 oz-in²) Use the direct coupling]

- 35mm(1.38)/1.8"
- 38mm(1.54)/0.9"
- 42mm(1.65)/0.9"
- 28mm(1.10)/1.8"
- 42mm(1.65)/1.8"
- 42mm(1.65)/1.8"
- 50mm(1.97)/1.8"
- 56mm(2.20)/1.8"
- 60mm(2.36)/1.8"
- 85mm(3.39)/1.8"
- 106mm(4.17)/1.8"
- 56mm(2.20)/CE
- 85mm(3.39)/CE
- 106mm(4.17)/CE
- 85mm(3.39)/CE
- 106mm(4.17)/CE
- Specifications of 2-phase stepping motor
- In-vacuum stepping motor
- 2-phase synchronous motor



2-phase Stepping Motor

106mm cir.
(4.17inch cir.)

103H8922 □
Conforming to the CE marking
1.8°/step



Specifications

Bipolar winding

Model		Holding torque at 2-phase energization	Rated current	Resistance	Inductance	Rotor inertia	Mass(Weight)
Single shaft	Double shaft	N·m (oz·in) MIN.	A/phase	Ω/phase	mH/phase	$\times 10^{-4}$ kg·m ² (oz·in ²)	kg(lbs)
103H89222-6341	-6311	13.2(1869.2)	6	0.45	5.4	14.6(79.83)	7.5(16.53)
103H89223-6341	-6311	19(2690.5)	6	0.63	8	22(120.28)	10.5(23.15)

Dimensions [Unit:mm(inch)]

103H89222-6341 (Single shaft)
103H89222-6311 (Double shaft)

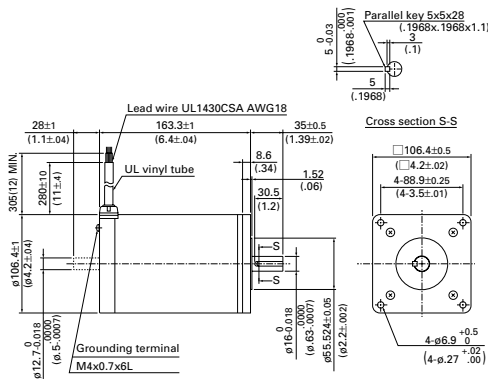

103H89223-6341 (Single shaft)
103H89223-6311 (Double shaft)

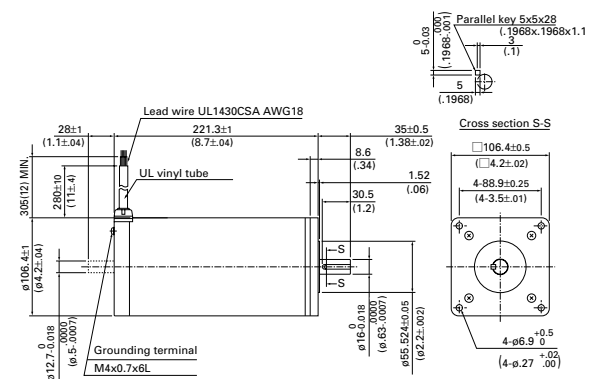

Pulse Rate - Torque Characteristics

● 103H89222-6341

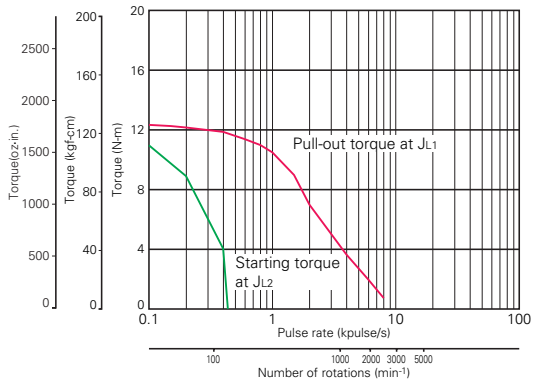

Sanyo constant current circuit
 Source voltage: AC100V Operating current: 6A/phase, 2-phase energization (full-step)
 J_{L1}=[43x10⁻⁴kg·m² (235.10 oz·in²) Use the rubber coupling]
 J_{L2}=[43x10⁻⁴kg·m² (235.10 oz·in²) Use the rubber coupling]

● 103H89223-6341

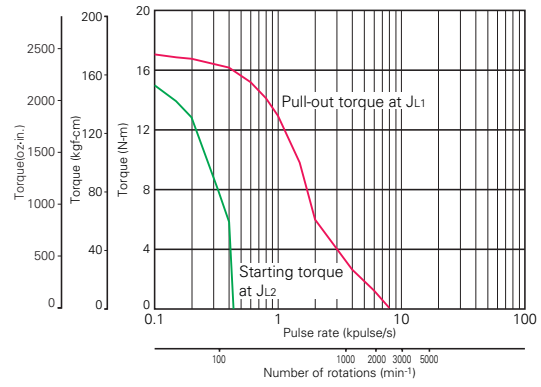

Sanyo constant current circuit
 Source voltage: AC100V Operating current: 6A/phase, 2-phase energization (full-step)
 J_{L1}=[43x10⁻⁴kg·m² (235.10 oz·in²) Use the rubber coupling]
 J_{L2}=[43x10⁻⁴kg·m² (235.10 oz·in²) Use the rubber coupling]

- 35mm(1.38)/1.8"
- 38mm(1.54)/0.9"
- 42mm(1.65)/0.9"
- 28mm(1.10)/1.8"
- 42mm(1.65)/1.8"
- 50mm(1.97)/1.8"
- 56mm(2.20)/1.8"
- 60mm(2.36)/1.8"
- 86mm(3.39)/1.8"
- 106mm(4.17)/1.8"
- 56mm(2.20)/CE
- 86mm(3.39)/CE
- 106mm(4.17)/CE

Specifications of 2-phase stepping motor

In-vacuum stepping motor

2-phase synchronous motor

Specifications of 2-Phase Stepping Motor

General Specifications

	103-4902	103-591	103-771 □	103H32 □□	103H52 □□
Insulation class	Class B (130°C)				
Insulation resistance	Not less than 100MΩ between winding and frame by DC500V megger or normal temperture and humidity.				
Withstand voltage	Without abnormality when applying 50/60Hz, 0.5kV AC (1KV AC for 103-771 □) for 1minute (leakage current 1mA) between winding and frame at nomal temperature and humidity.				
Operating environment	Ambient temperature: -10°C~+50°C				
	Ambient humidity: 20~90% RH (no condensation)				
Winding temperature rise	80K MAX. (Based on Sanyo Denki standard)				
Standing angle error	±0.045°	±0.054°	±0.045°	±0.09°	±0.09°
Axial play	0.075mm(0.003inch) MAX	0.075mm(0.003inch) MAX	0.075mm(0.003inch) MAX	0.075mm(0.003inch) MAX	0.075mm(0.003inch) MAX
	Load 4.4N(1lbs)	Load 4.4N(1lbs)	Load 9N(2lbs)	Load 4.4N(1lbs)	Load 4.4N(1lbs)
Radial play (Note 1)	0.025mm(0.001inch) MAX Load 4.4N(1lbs)				
Shaft runouts	0.025mm(0.001inch)				
Concentricity of mounting spigot relative to shaft	ø0.05mm(0.002inch)	ø0.05mm(0.002inch)	ø0.075mm(0.003inch)	ø0.05mm(0.002inch)	ø0.05mm(0.002inch)
Perpendicularity of mounting surface relative to shaft	0.075mm(0.03inch)	0.075mm(0.03inch)	0.075mm(0.003inch)	0.1mm(0.004inch)	0.1mm(0.004inch)

(Note 1) When load is applied at 1/3 length from output shaft edge.

	103H670 □	103H712 □	103H782 □	103H822 □□	103H8922 □□
Insulation class	Class B (130°C)				
Insulation resistance	Not less than 100MΩ between winding and frame by DC500V megger or normal temperture and humidity.				
Withstand voltage	Without abnormality when applying 50/60Hz, 1kV AC for 1minute (leakage current 1mA) between winding and frame at nomal temperature and humidity.				
Operating environment	Ambient temperature: -10°C~+50°C				
	Ambient humidity: 20~90% RH (no condensation)				
Winding temperature rise	80K MAX. (Based on Sanyo Denki standard)				
Standing angle error	±0.09°	±0.054°	±0.054°	±0.09°	±0.09°
Axial play	0.075mm(0.003inch) MAX	0.075mm(0.003inch) MAX	0.075mm(0.003inch) MAX	0.075mm(0.003inch) MAX	0.075mm(0.003inch) MAX
	Load 9N(2lbs)	Load 9N(2lbs)	Load 9N(2lbs)	Load 9N(2lbs)	Load 9N(2lbs)
Radial play (Note 1)	0.025mm MAX. Load 4.4N(1lbs)				
Shaft runouts	0.025mm(0.001inch)				
Concentricity of mounting spigot relative to shaft	ø0.075mm(0.003inch)	ø0.075mm(0.003inch)	ø0.075mm(0.003inch)	ø0.075mm(0.003inch)	ø0.075mm(0.003inch)
Perpendicularity of mounting surface relative to shaft	0.075mm(0.003inch)	0.075mm(0.003inch)	0.075mm(0.003inch)	0.075mm(0.003inch)	0.075mm(0.003inch)

(Note 1) When load is applied at 1/3 length from output shaft edge.

General Specifications (CE Marked Models)

	103H712 □	103H822 □	103H8922 □
Rated voltage	12-200VDC	12-300VDC	12-300VDC
Applied standards(Low voltage directive)	EN60034-1, IEC34-5(EN60034-5),EN60204-1,EN60950,EN61010-1		
Operation type	S1 (continuous rating)		
Protection grade	IP43		
Device category	Class I		
Operation environment	Pollution dgree		
Insulation class	Class B (130°C)		
Insulation resistance	Not less than 100MΩ between winding and frame by DC500V megger or normal temperture and humidity.		
Withstand voltage	Without abnormality when applying 50/60Hz, 1600V AC (1500V AC for 103H712 □) for 1minute (leakage current 10mA) between winding and frame at nomal temperature and humidity.		
Operating environment	Ambient temperature: -10°C~+40°C		
	Ambient humidity 20~90% (no condensation)		
Winding temperature rise	80K MAX. (Based on Sanyo Denki standard)		
Standing angle error	±0.054°	±0.09°	±0.09°
Axial play	0.075mm(0.003inch) MAX. Load 9N(2lbs)		
Radial play (Note 1)	0.025mm(0.001inch) MAX. Load 4.4N(1lbs)		
Shaft runouts	0.025mm(.001inch)		
Concentricity of mounting spigot relative to shaft	ø0.075mm(0.003inch)	ø0.075mm(0.03inch)	ø0.075mm(0.03inch)
Perpendicularity of mounting surface relative to shaft	0.1mm(0.04inch)	0.1mm(0.004inch)	0.1mm(0.004inch)

(Note 1) When load is applied at 1/3 length from output shaft edge.

Allowable radial load / thrust load

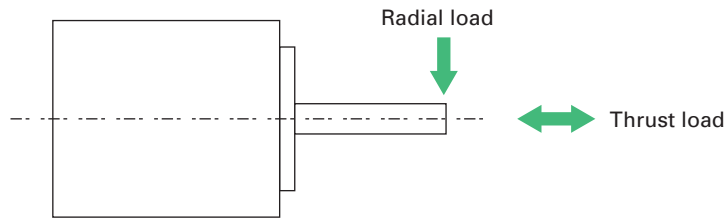

Frange size	Model. No.	Distance from end of shaft:mm (inch)				Thrust load N(lbs)
		0	5(0.20)	10(0.39)	15(0.59)	
		Radial load:N(lbs)				
□28mm(□1.10inch)	103H32□□	30(6)	38(8)	53(11)	84(18)	3(0.67)
□35mm(□1.38inch)	SH35□□	40(8)	50(11)	67(15)	98(22)	10(2.25)
□39mm(□1.54inch)	103-49□□	43(9)	59(13)	93(20)	216(48)	30(6.75)
□42mm(□1.65inch)	103H52□□	22(4)	26(5)	33(7)	46(10)	10(2.25)
	103-59□					
□50mm(□1.97inch)	103H670□	71(15)	87(19)	115(25)	167(37)	15(3.37)
□56mm(□2.20inch)	103H712□	52(11)	65(14)	85(19)	123(27)	15(3.37)
	103H7128	85(19)	105(23)	138(31)	200(44)	15(3.37)
φ 56mm(φ 2.20inch)	103-77□□	75(16)	92(20)	121(27)	176(39)	15(3.37)
□60mm(□2.36inch)	103H782□	70(15)	87(19)	114(25)	165(37)	20(4.50)
φ 86mm(φ 3.39inch)	103H822□	191(42)	234(52)	301(67)	421(94)	60(13.488)
φ 106mm(φ 4.17inch)	103H8922□	321(72)	356(80)	401(90)	457(102)	100(22.48)

□35mm(□1.38inch)
 □38mm(□1.54inch)
 □28mm(□1.10inch)
 □42mm(□1.65inch)
 □50mm(□1.97inch)
 □56mm(□2.20inch)
 φ86mm(φ3.39inch)
 φ106mm(φ4.17inch)
 φ56mm(φ2.20inch)
 φ86mm(φ3.39inch)
 φ106mm(φ4.17inch)

Specifications of
 2-phase stepping motor

In-vacuum
 stepping motor

2-phase
 synchronous motor

Internal Wiring and Rotation Direction

Unipolar winding

● 103H32□□

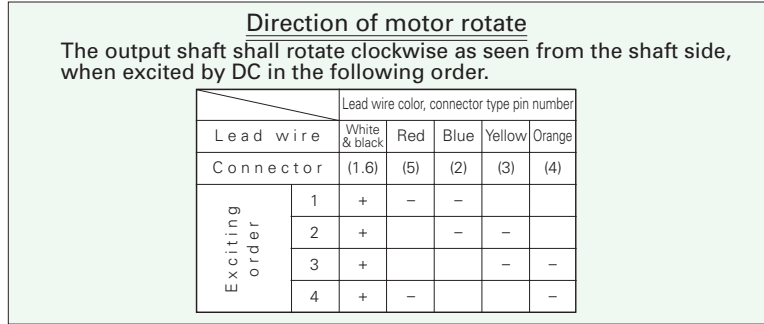
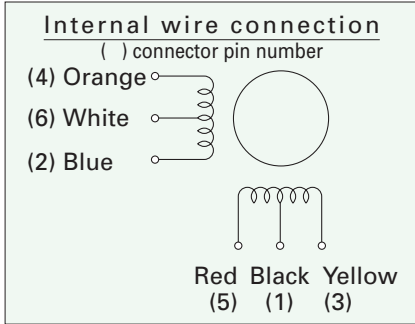

● 103H52□□

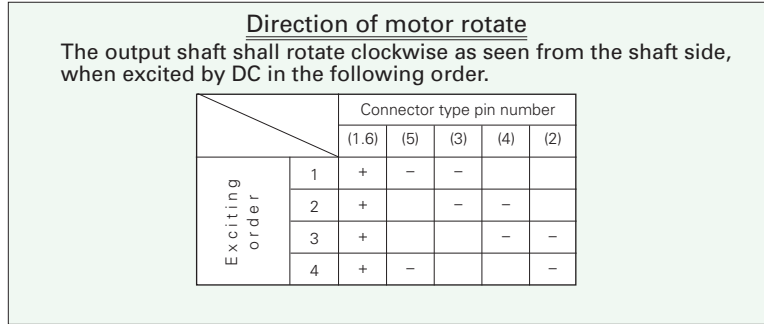
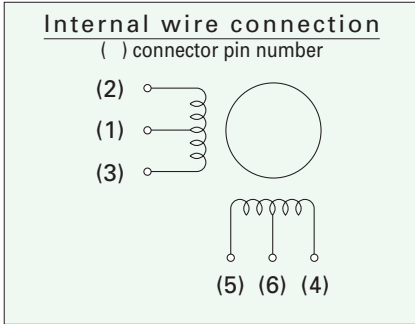

● 103H782□

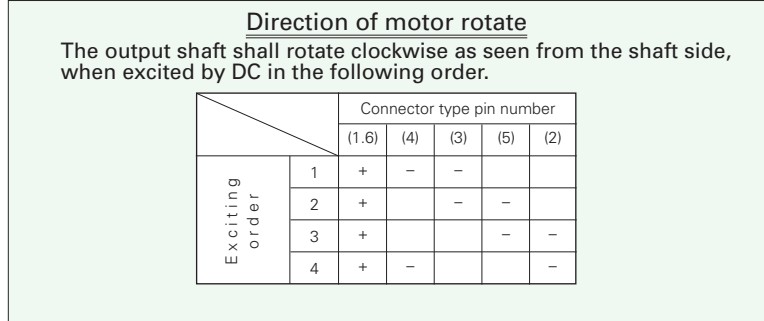
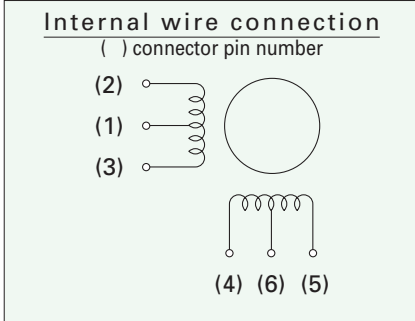

● Other than 103H32□□, 103H52□□, 103H782□

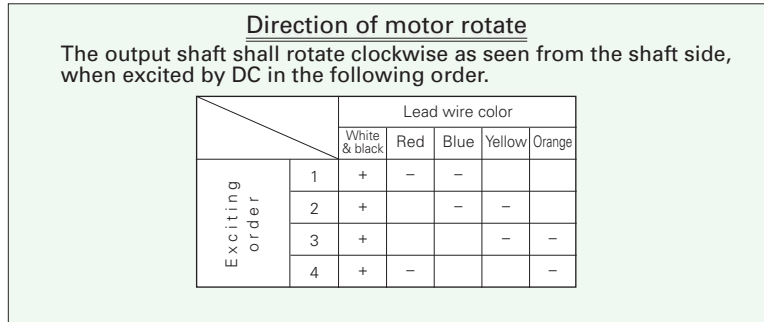
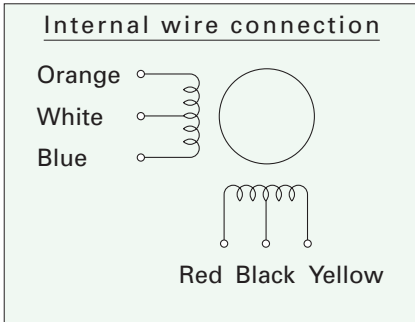

Bipolar winding

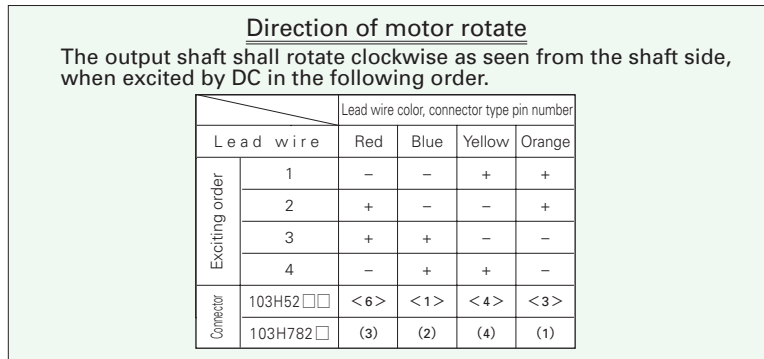
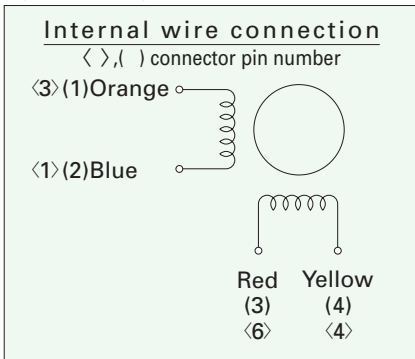

2-phase
synchronous motor

In-vacuum
stepping motor

Specifications of
2-phase stepping motor

ø106mm(4.17)/CE

ø86mm(3.39)/CE

56mm(2.20)/CE

ø106mm(4.17)/1.8°

ø86mm(3.39)/1.8°

60mm(2.36)/1.8°

56mm(2.20)/1.8°

50mm(1.97)/1.8°

42mm(1.65)/1.8°

28mm(1.10)/1.8°

38mm(1.54)/0.9°
42mm(1.65)/0.9°

35mm(1.38)/1.8°



2-Phase Synchronous Motor

Principle

- The stepping motor is transformed into a synchronous motor by replacing the wound-wire for the AC power specification.
- A synchronous motor rotates at a constant speed in proportion to the AC power frequency of which current is applied directly to the wound-wire, while a stepping motor rotates in accordance with the switched phase by the driving circuit.
- The 2-phase synchronous motor is driven by the phase shifter (condenser and resistor) used on the supplied single phase current.

Characteristics

- A constant rotation speed is maintained without slip within the load range to the motor torque.
- Enables ultra-low speed rotation and high torque.
- Enables cost saving as it operates on the commercial power supply and therefore the driving circuit is not required.

Range of Uses

- Widely used in various fields such as conveyer drives, printers, cryopump ultimate freezers, and general industrial devices.

General Specifications

	103H7093-0140	103H823□	103H8923□	103-830-0140
Insulation class	Class B (130°C)			
Insulation resistance	Not less than 100MΩ between winding and frame by DC500V megger or normal temperature and humidity.			
Withstand voltage	Without abnormality when applying 50/60Hz, 1KV AC for 1minute (leakage current 1mA) between winding and frame at normal temperature and humidity.			
Operating environment	Ambient temperature: -10°C~+50°C			
	Ambient humidity: 20~95% RH (no condensation)			
Winding temperature rise	80K MAX (Based on Sanyo Denki standard)			
Axial play	0.075mm(0.003inch) MAX			
	Load 9N (2lbs)			
Radial play (Note 1)	0.025mm(0.001inch) MAX Load 4.4N(1lbs)			
Shaft runouts	0.025mm(0.001inch)			
Concentricity of mounting spigot relative to shaft	ø0.075mm(0.003inch)	ø0.075mm(0.003inch)	ø0.075mm(0.003inch)	ø0.075mm(0.003inch)
Perpendicularity of mounting surface relative to shaft	0.075mm(0.003inch)	0.075mm(0.003inch)	0.075mm(0.003inch)	0.075mm(0.003inch)
Allowable thrust load	15N(3.4lbs)	60N(13.5lbs)	100N(22.5lbs)	60N(13.5lbs)
Allowable radial load (Note 1)	75N(16.9lbs)	220N(49.5lbs)	360N(80.9lbs)	130N(29.2lbs)

(Note 1) When load is applied at 1/3 length from output shaft edge.

Internal wiring and rotation direction

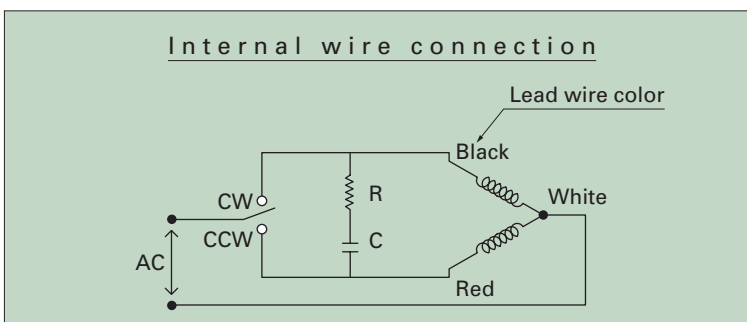

Direction of motor rotate

The output shaft shall rotate clockwise as seen from the shaft side, when the switch is selected CW at the internal wiring indicated left.

Specifications

Model	Synchronous pull-out torque	Rated voltage	Rated current	Phase shifter		Number of rotation (min ⁻¹)		Mass(Weight) kg(lbs)	
	N-m(oz-in) MIN.			VAC	A	Capacitor (μF)			Resister (Ω)
		50Hz	60Hz			50Hz	60Hz		
103H7093-0140	0.568(80.4)	100	0.15	1.7	1.7	-	60	72	0.65(1.43)
103H8231-0140	1.6(226.6)	100	0.5	6.75	5	180	60	72	1.5(3.31)
103H8232-0240	3(424.8)	220	0.5	2.4	1.8	500	60	72	2.5(5.51)
103H89235-0140	2.6(368.2)	120	0.4	-	-	-	60	72	5(11.02)
103H89236-0140	5.5(778.8)	120	0.9	-	-	-	60	72	7.5(16.53)
103-830-0140	0.54(76.5)	120	0.33	3.75	3.75	300	166	200	2.5(5.51)

Dimensions [Unit:mm(inch)]

103H7093-0140

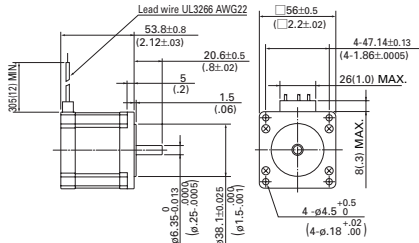

103H8231-0140

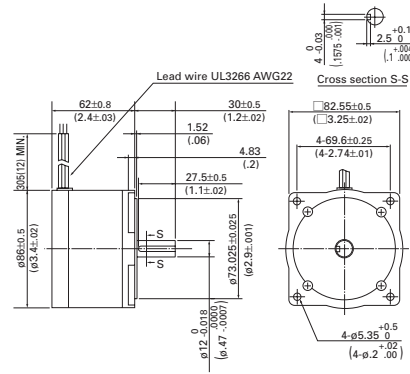

103H8232-0240

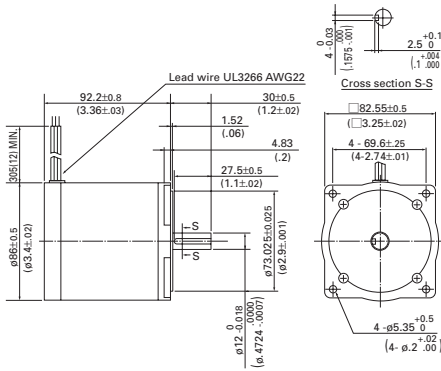

103H89235-0140

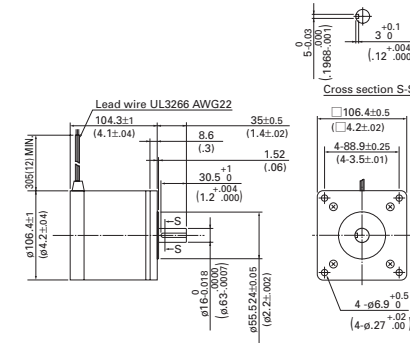

103H89236-0140

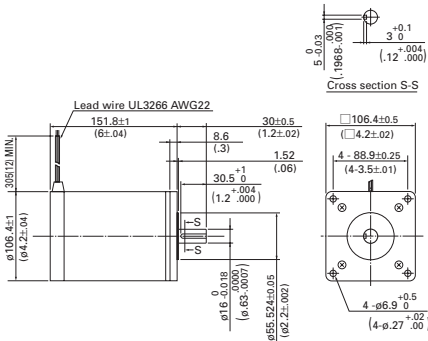

103-830-0140

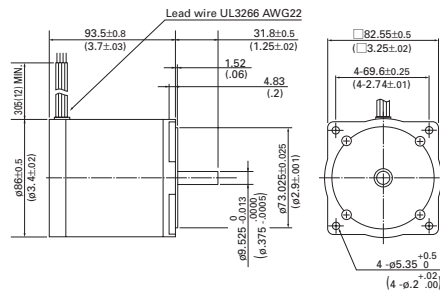

±.35mm(1.38)/1.8"

±.39mm(1.54)/0.9"

±.42mm(1.65)/0.9"

±.28mm(1.10)/1.8"

±.42mm(1.65)/1.8"

±.50mm(1.97)/1.8"

±.56mm(2.20)/1.8"

±.60mm(2.36)/1.8"

±.85mm(3.39)/1.8"

±.106mm(4.17)/1.8"

±.56mm(2.20)/CE

±.86mm(3.39)/CE

±.106mm(4.17)/CE

Specifications of 2-phase stepping motor

In-vacuum stepping motor

2-phase synchronous motor

2-Phase Stepping Motor for Vacuum Environment

1. What Is Stepping Motor for Vacuum Environment

We have developed the stepping motor for use under a vacuum environment in response to the demand for the actuator that can operate without a vacuum introducer.

The stepping motor for a vacuum environment secures the highly accurate operation in speed control and position control by the open-loop control system, the features realized with the general stepping motor.

2. Characteristics

- Enables use in a vacuum environment of ultrahigh degree (10^{-8} Pa).
- Enables baking at the temperature 200°C.
- A line of the product models is available to be selected for various uses.

3. Range of Uses

The stepping motors for vacuum environment are utilized in the devices of the following fields.

- Industrial robots on satellites (Space industry)
- Semiconductor production systems
- Scanning electron microscopes
- Large scale experiment facilities (Particle accelerator, radial light analyzer) etc.

General Specifications

	103-770-12V1
Insulation class	Class C (200°C)
Insulation resistance	100MΩ MIN. when measured with a DC500V megohmmeter between the motor wiring and the frame at normal temperature and humidity.
Withstand voltage	Not influenced when applied 1kVAC, 50/60Hz between the motor wound-wire and the frame for 1 minute (leak current 1mA) at room temperature and humidity.
Ambient pressure	10^{-8} Pa (reference value)
Standing angle error	$\pm 0.09^\circ$
Axial play	0.075mm(0.003inch) MAX (With 9N loaded)
Radial play (Note 1)	0.025mm(0.001inch) MAX (With 4.4N loaded)
Shaft runouts	0.025mm(0.001inch)
Concentricity of mounting spigot relative to shaft	$\phi 0.075$ mm(0.003inch)
Perpendicularity of mounting surface relative to shaft	0.075mm(0.003inch)
Allowable thrust load	15N
Allowable radial load (Note 1)	80N

(Note 1) When load is applied at 1/3 length from output shaft edge.

● 103-770-12V1

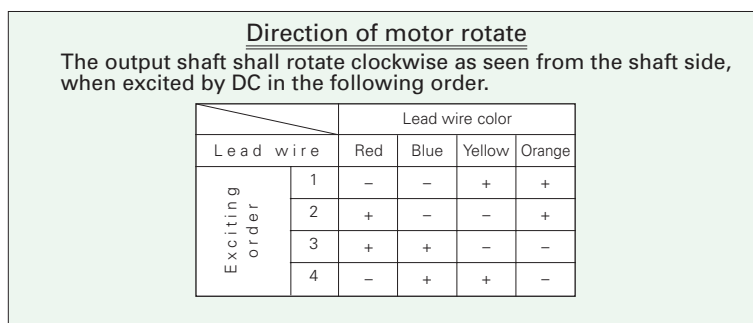
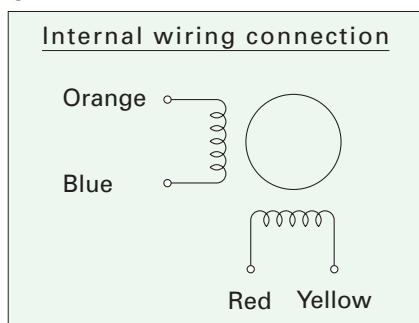



The Stepping Motor for Ultra-vacuum Environment

Ambient pressure 10^{-9} Pa
(reference value)

Specifications

Model	Basic step angle	Holding torque at 2-phase energization	Rated current	Resistance	Inductance	Rotor inertia	Mass(Weight)
		N·m(oz-in) Min	A/phase	Ω /phase	mH/phase	$\times 10^{-4}$ kg·m ² (oz-in ²)	kg(lbs)
103-770-12V1	1.8°	0.421(59.6)	2.2	0.73	2.12	0.105(0.57)	0.8(1.76)

Dimensions [Unit:mm(inch)]

103-770-12V1

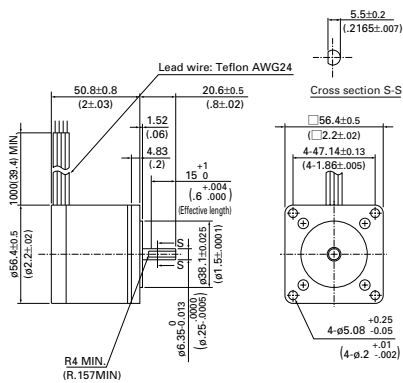

Pulse Rate - Torque Characteristics

● **103-770-12V1**

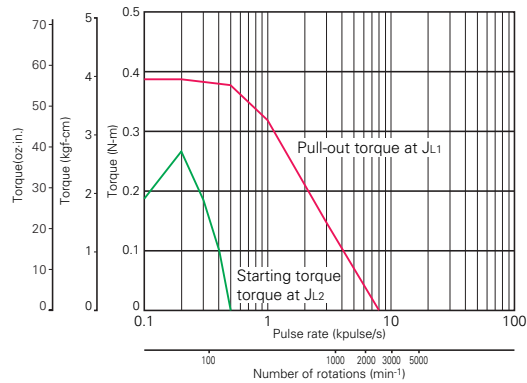

Sanyo constant current circuit

Source voltage: DC24V Operating current: 2A/phase, 2-phase energization (full-step)

J_{L1}= 0.94×10^{-4} kg·m² (5.14 oz-in²) Use the rubber coupling]

J_{L2}= 0.8×10^{-4} kg·m² (4.37 oz-in²) Use the direct coupling]

Specifications of
 2-phase
 stepping motor
 In-vacuum
 stepping motor
 2-phase
 synchronous motor
 35mm(1.38)/1.8°
 38mm(1.54)/0.9°
 42mm(1.65)/0.9°
 28mm(1.10)/1.8°
 42mm(1.65)/1.8°
 50mm(1.97)/1.8°
 56mm(2.20)/1.8°
 60mm(2.36)/1.8°
 68mm(3.39)/1.8°
 106mm(4.17)/1.8°
 56mm(2.20)/CE
 68mm(3.39)/CE
 106mm(4.17)/CE

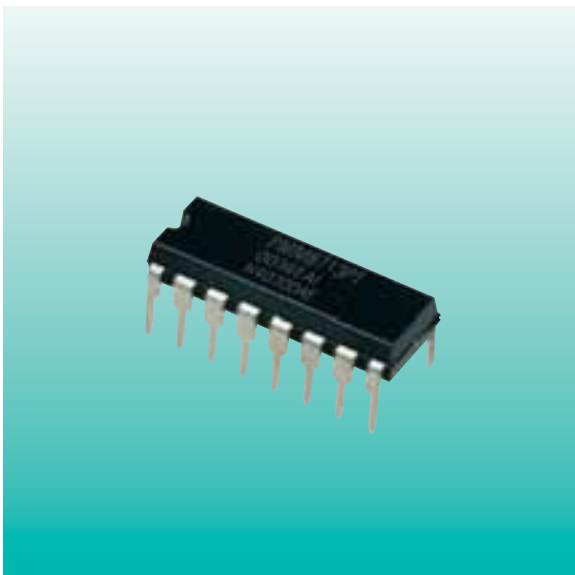

Universal Controller IC for the 2-Phase Stepping Motor Drive PMM8713PT

Outline

The universal controller "PMM8713PT" is the gate array IC (HIC) to control the 2-phase stepping motor drive. This product has been developed for the purpose to further simplify 2-phase stepping motor use, as combined only with switching elements or power hybrid ICs to configure a 2-phase stepping motor driver.

Characteristics

- Universal controller : The following 3 types of energization mode can be selected by switching at the energization mode switching terminal 1EX / 1-2EX / 2EX
- Source voltage : $V_{CC}=4.5\sim 5.5V$
- High output current : 24mA MIN. (sink, source)
- High noise margin : Schmitt trigger circuit is incorporated for the all input terminals.
- 2 types of pulse input : 2 input mode (CW, CCW input mode)
Pulse and direction mode (CK, U/D input mode)
- Excited status verification monitor : Outputs the monitor signal of the controller status.

Maximum Rating (Ta=25°C)

Item	Symbol	Rating	Unit
Source voltage	V_{CC}	-0.3~7	V
Output current ø	"H" level $I_{OH\ \emptyset}$	-35	mA
	"L" level $I_{OL\ \emptyset}$	35	
Output current Co,Em	"H" level I_{OH}		µA
	"L" level I_{OL}		
Input voltage	V_{IN}	-0.3~ $V_{CC}+0.3$	V
Input current	I_{IN}	±10	mA
Operating current	T_{opr}	-20~85	°C
Conservation temperature	T_{stg}	-40~125	°C

Recommended Operating Conditions (Ta=-20~85°C)

Item	Symbol	Rating			Unit
		MIN.	Standard	MAX.	
Source voltage	V_{CC}	4.5	-	5.5	V
Output current ø	"H" level $I_{OH\ \emptyset}$	-24	-	-	mA
	"L" level $I_{OL\ \emptyset}$	24	-	-	
Output current Co,Em,HL	"H" level I_{OH}	-2	-	-	mA
	"L" level I_{OL}	2	-	-	
Input voltage	V_{IN}	0	-	V_{CC}	V

Dimensions [Unit: mm(inch)]

Pin No.	Name	Function
1.	Cu	Input pulse UP clock input
2.	Cd	Input pulse DOWN clock input
3.	Ck	Input pulse clock input
4.	U/D	Rotation direction conversion
5.	Ea	energization mode switching input
6.	Eb	energization mode switching input
7.	ec	energization mode switching input
8.	Vss	GND
9.	R	Reset input
10.	ø4	ø4 output
11.	ø3	ø3 output
12.	ø2	ø2 output
13.	ø1	ø1 output
14.	EM	energization monitor output
15.	Co	Input pulse monitor output
16.	Vcc	4.5~5.5V

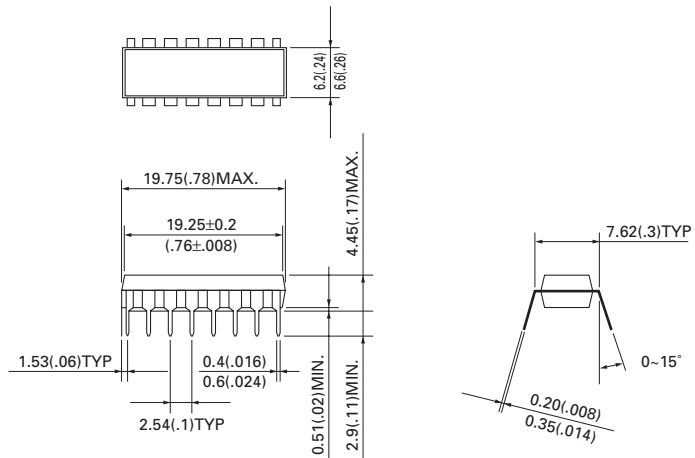

Electrical Characteristics

Direct current characteristics (Ta=-20~85°C)

Item	Symbol	Vcc [V]	Condition	Standard value			Unit	
				MIN.	Standard	MAX.		
Input voltage	"H" level	V _{IH}	5	—	3.5	—	—	V
	"L" level	V _{IL}	5	—	—	—	1.5	
Output voltage	"H" level	V _{OH}	5	V _H = 5V V _L = 0V I _{OH} = 0	4.9	—	—	V
	"L" level	V _{OL}	5	V _H = 5V V _L = 0V I _{OH} = 0	—	—	0.1	
Output current ø1~ø4	"H" level	I _{OH}	5	V _H = 5V V _L = 0V V _{OUT} = 2.4V	-24	—	—	mA
	"L" level	I _{OL}	5	V _H = 5V V _L = 0V V _{OUT} = 0.4V	24	—	—	
Output current Co,EM	"H" level	I _{OH}	5	V _H = 5V V _L = 0V V _{OUT} = 2.4V	-2	—	—	mA
	"L" level	I _{OL}	5	V _H = 5V V _L = 0V V _{OUT} = 0.4V	2	—	—	
Input current	I	5	—	—	—	10	—	µA
Static current consumption	I _{CC}	5	V _H = 5V V _L = 0V	—	—	1	—	mA

Switching characteristics (Ta=-20~85°C)

Item	Symbol	Vcc [V]a	Condition	Standard value			Unit
				MIN.	Standard	MAX.	
MAX. clock frequency	f _{MAX}	5	tr=tf=20ns,CL=50pF	1	—	—	MHz
MIN. width of clock pulse	t _{WL} ,t _{WH}	5	tr=tf=20ns,CL=50pF	—	—	500	ns
MIN. width of reset pulse	t _{WR}	5	tr=tf=20ns,CL=50pF	—	—	1000	ns
Time delay (from clock input to ø output)	t _{pd}	5	tr=tf=20ns,CL=50pF	—	—	2000	ns
Set time	t _{SET}	5	tr=tf=20ns,CL=50pF	0	—	—	ns
Holding time	t _{HOLD}	5	tr=tf=20ns,CL=50pF	250	—	—	ns

Electrical Characteristics

Measured waveforms on switching time scale

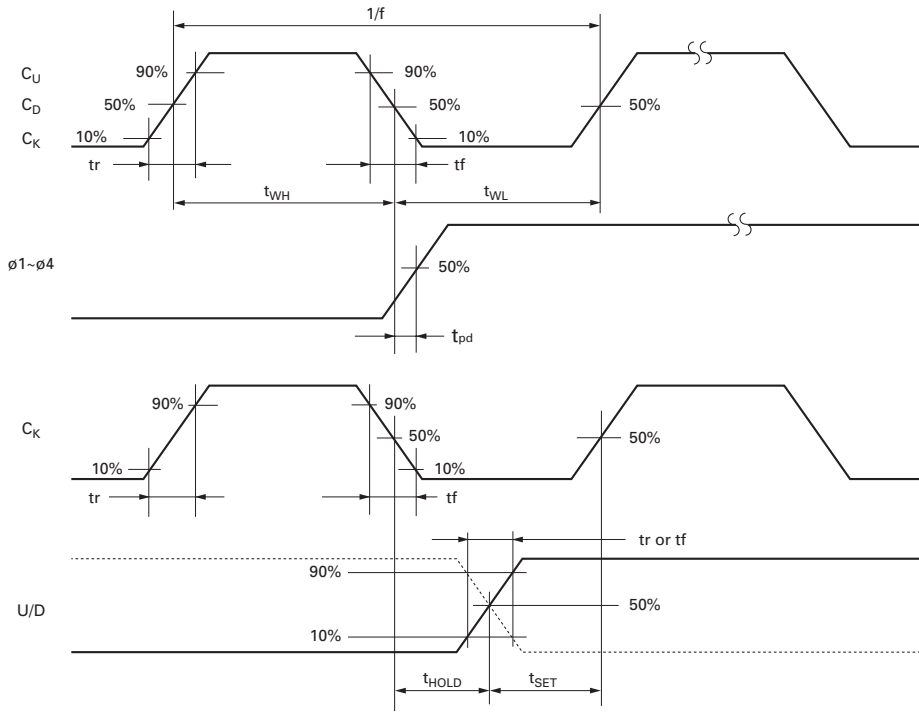

Function Table

Input modes and rotation direction

Input mode	Input				Rotation direction
	C _U	C _D	C _K	U/D	
2 input mode (CW,CCW)		L	L	L	CW
	L		L	L	CCW
Pulse and direction mode (CK, U/D)	L	L		H	CW
	L	L		L	CCW

Energization modes

Excitation mode	Input			
	\bar{R}	E _A	E _B	ø _c
1 EX	H	H	L	H
1-2EX	H	H	H	H
2 EX	H	L	L	H

Energization Sequence

1EX

Pulse Phase	0 (Reset)	1	2	3	4
ø1	1	0	0	0	1
ø2	0	1	0	0	0
ø3	0	0	1	0	0
ø4	0	0	0	1	0
E _M	0	0	0	0	0
UP	➔				
DOWN	➔				

2EX

Pulse Phase	0 (Reset)	1	2	3	4
ø1	1	1	0	0	1
ø2	0	1	1	0	0
ø3	0	0	1	1	0
ø4	1	0	0	1	1
E _M	1	1	1	1	1
UP	➔				
DOWN	➔				

1-2EX

Pulse Phase	0 (Reset)	1	2	3	4	5	6	7	8
ø1	1	1	1	0	0	0	0	0	1
ø2	0	0	1	1	1	0	0	0	0
ø3	0	0	0	0	1	1	1	0	0
ø4	1	0	0	0	0	0	1	1	1
E _M	1	0	1	0	1	0	1	0	1
UP	➔								
DOWN	➔								

• Reset after changing the energization mode.

Input Pulse Monitor

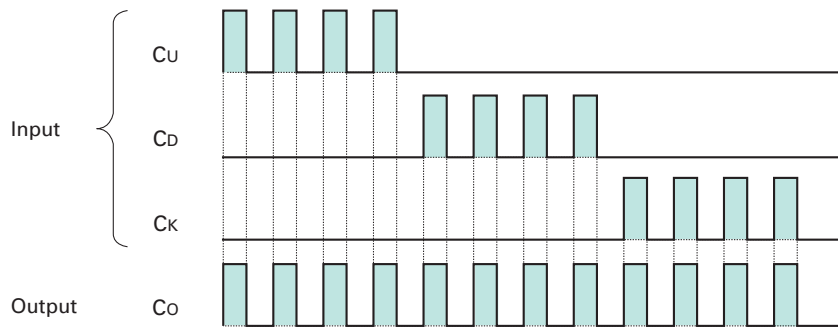

Example of Application Circuit (Bipolar wiring motor)

- Combined with the power hybrid IC

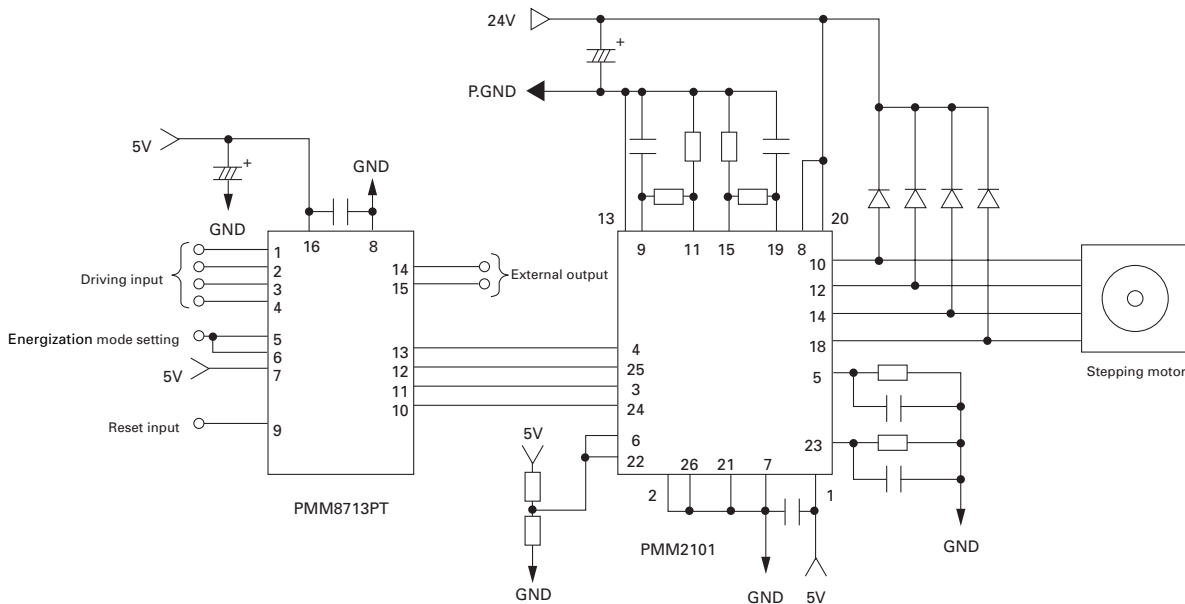

Energization mode setting

Pin No.	Terminal symbol	Input level	Motor operation
5,6	E _A ,E _B	H	1-2EX
		L	2EX

- The normal initial reset may not be performed during unstable VCC after turning the power ON. For reliable resetting, hold the R terminal (9-pin) at the "L" level till the VCC becomes stable.

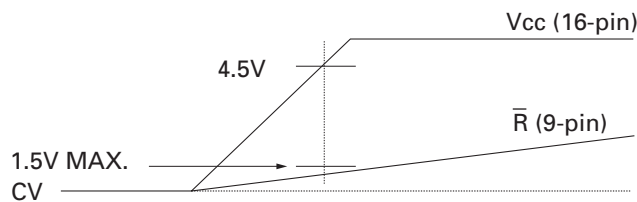

- Power hybrid IC: Refer to page 117 for the PMM2101 specifications.
- Refer to the PMM8713PT Operation Manual for other application circuit examples.

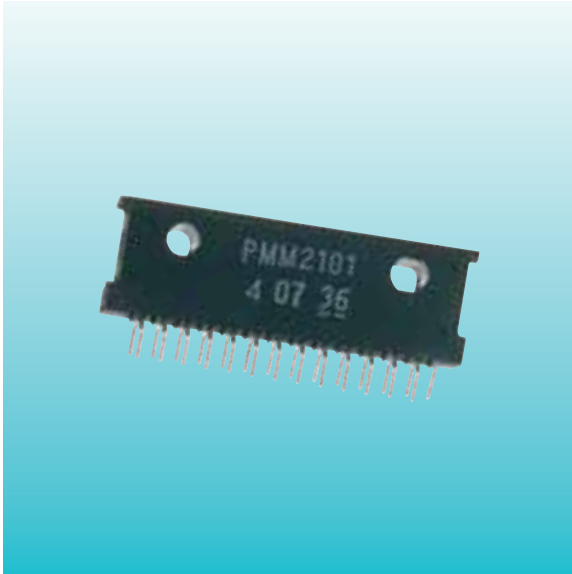

HIC for 2-Phase Stepping Motor

PMM2101

Full Step / Half Step

Outline

The stepping motor driver IC "PMM2101" is a monolithic-type power hybrid driver IC (HIC) packaging the circuits for 2-phase stepping motor driving.

This product is developed for the purpose to further simplify 2-phase stepping motor use, as combined only with the universal controller "PMM8713PT" for stepping motor driving, or the step sequence circuit, to configure a 2-phase stepping motor driver.

Characteristics

- Enables high speed and high torque operation by using bipolar constant current switching method.
- Enables compact driving circuit configuration with few of externally attached parts.
- The overheat protection circuit is incorporated to assist the safety design.

Maximum Rating (T_C=25°C)

Item	Symbol	Rated value	Unit
Source voltage -1	V _{CC1}	8~60	V
Source voltage -2	V _{CC2}	0~7	V
Output current	I _O	1.4	A
Allowable loss	P _T	35 (T _C =25°C)	W
Thermal resistance	θ _{JC}	3.57	°C/W
	θ _{JA}	25	°C/W
Junction temperature	T _{Jmax}	150	°C
Conservation temperature	T _{stg}	-40~150	°C

Recommended Operating Conditions (T_C=25°C)

Item	Symbol	Rated value	Unit
Source voltage -1	V _{CC1}	100~50	V
Source voltage -2	V _{CC2}	4.75~5.25	V
Output current	I _O	1.0	A
Oscillator frequency	F _C	20~27	kHz
Operation temperature	T _C	-25~85	°C

Dimensions [Unit: mm(inch)]

Pin No.	Name	Function
1.	Vcc2	Power terminal for controller section
2.	ENA A	Enable input terminal
3.	ø1	Arm drive input
4.	ø2	Arm drive input
5.	CR A	One shot time constant setting terminal
6.	Vref A	Motor current setting terminal
7.	LG A	GND
8.	Vcc1 A	Motor driver power terminal
9.	VsA	Motor current detection terminal
10.	M1	Motor output
11.	Rs A	Detection resistor connecting terminal
12.	M2	Motor output
13.	PG	P.GND
14.	M3	Motor output
15.	Rs B	Detection resistor connecting terminal
16.	NC	-
17.	NC	-
18.	M4	Motor output
19.	Vs B	Motor current detection terminal
20.	Vcc1 B	Motor driver power terminal
21.	LG B	GND
22.	Vref B	Motor current setting terminal
23.	CR B	One shot time constant setting terminal
24.	ø3	Arm drive input
25.	ø4	Arm drive input
26.	ENA B	Enable terminal
27.	AL	Overheat alarm output terminal

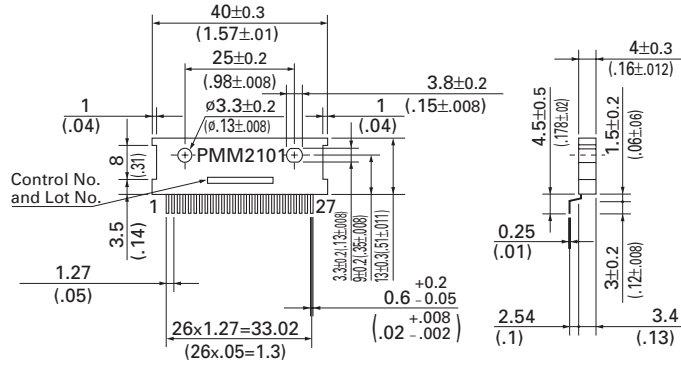

Operational truth value table

ENA A (ENA B)	ø1 (ø3)	ø2 (ø4)	M1 (M3)	M2 (M4)
L	L	L	OFF	OFF
L	L	H	L	H
L	H	L	H	L
L	H	H	OFF	OFF
H	-	-	OFF	OFF

Electrical Characteristics (Ta= -20~120°C)

Item	Symbol	Condition	Rating			Unit
			MIN.	Standard	MAX.	
"H" level input voltage	V _{IH}	V _{CC2} =5V	2.7	-	V _{CC2}	V
"L" level input voltage	V _{IL}	V _{CC2} =5V	0	-	1.0	V
"H" level input current	I _{IH}	V _{CC2} =5V, V _i =5V	-	-	10	μA
"L" level input current	I _{IL}	V _{CC2} =5V, V _i =0V	-	-	-50	μA
Reference voltage (V _{ref}) input current	I _{ref}	V _{CC2} =5V, V _{ref} =0V	-	-	-10	μA
Current detection (V _s) input current	I _s	V _{CC2} =5V, V _s =0V	-	-	-10	μA
Forward direction voltage of FET diod	V _F	I _F =1A	-	1.3	1.5	V
High output saturating voltage	V _{ce(sat)H}	I _c =1A	-	1.0	1.4	V
Low output saturating voltage	V _{ce(sat)L}	I _c =1A	-	1.0	1.3	V
Output leak current	I _R	V _{CC1} =60V, V _{OUT} =0V	-	-	10	μA
		V _{OUT} =60V, V _{RS} =0V	-	-	10	μA
Power current to controller section	I _{CC2}	V _{CC2} =5V(during circuit operation)	-	-	75	mA
Alarm terminal current	I _{alm}	V _{CC2} =5V, V _{alm} =0.5V	-	-	2	mA
Overheat alarm operating temperature	-	-	-	125	-	°C
Overheat protection stop temperature	-	-	-	150	-	°C

Overheat Alarm Output

The overheat protection circuit outputs an alarm signal at +125°C at the internal junction in the IC, and activates (motor excitation OFF) at +150°C.

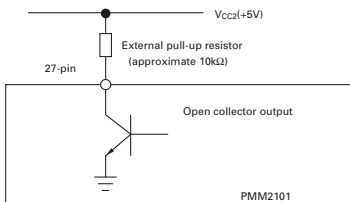

- Transistor ON during alarming
V_{ce} (ON): 0.5V MAX.
I_{alm}: 2mA MAX.
- The alarming signal output and overheat protection circuit recover automatically when the temperature lowers.

Example of Application Circuit

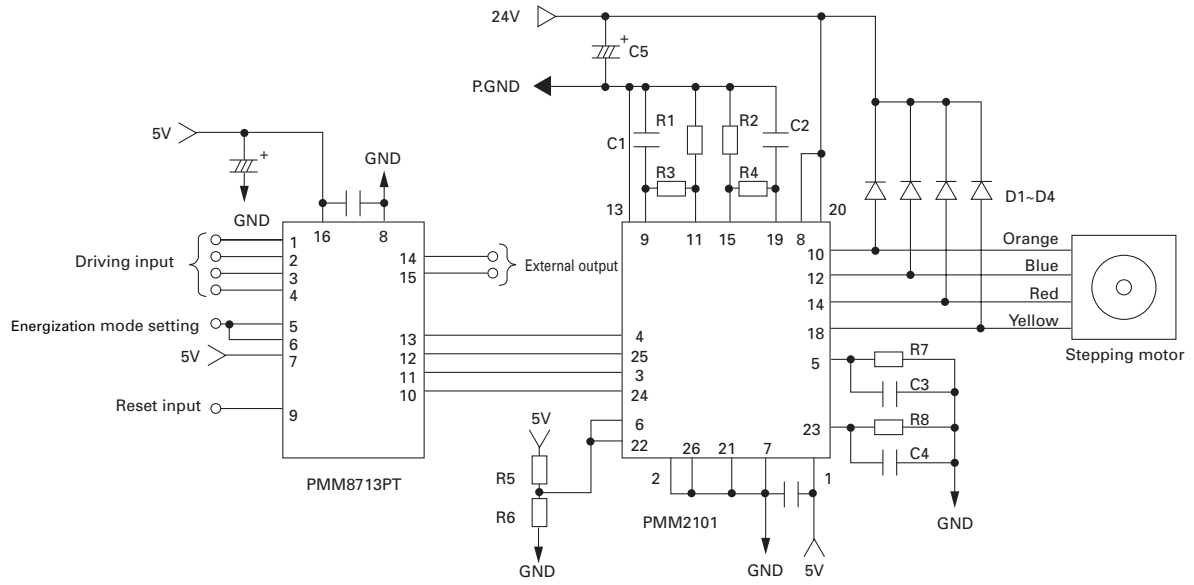

- Refer to page 113 for the PMM8713PT specifications.
- Recommended circuit constants for PMM2101

APPLICABLE	CONSTANT	APPLICABLE	CONSTANT
R1,R2	5W 0.68Ω	C1,C2	1000pF
R3,R4	1/4W 3.9kΩ	C3,C4	3300pF
R7,R8	1/4W 15kΩ	C5	330μF

- Determine on the R5 and R6 constants referring to the V_{ref} -output current characteristics.
- Determine on D1~D4.
 - Peak reverse voltage $\geq 100V$
 - Output current $\geq 1A$
 - Reverse recovery time $\leq 100ns$

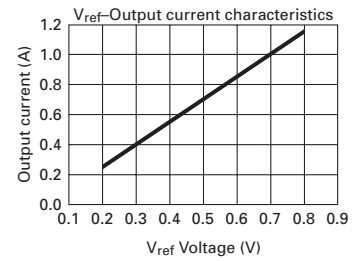

PMM8713PT

PMM2101

PMM2301



HIC for 2-Phase Stepping Motor

PMM2301

Micro Step

Outline

The Stepping motor driver IC “PMM2301” is a power hybrid IC (HIC) packaging the integrated excitation mode generation circuits and related switching elements for 2-phase stepping motor driving.

This product is developed for the purpose to further simplify 2-phase stepping motor use, as combined only with a few peripheral parts to configure a 2-phase stepping motor driver.

Characteristics

- Sine wave driven micro-step driver.
- The current detection resistor is incorporated.
- MOSFET is used for the power driving circuit to reduce heating.
- Totally packaged to reduce parts for the peripheral circuit.
- Enables selection from the 5 various excitation modes by the external bit signal.

Maximum Rating (T_c=25°C)

Item	Symbol	Condition	Rated value	Unit
Source voltage -1	V _{CC1 max}	V _{CC2} =0V	52	V
Source voltage -2	V _{CC2 max}	With no signal	7	V
Input voltage	V _{in max}	Logic input terminal	7	V
Phase current	I _{OH max}	0.5sec, 1pulse, V _{CC1} applied	4	A
Operating temperature on PCB	T _{C max}	–	105	°C
Junction temperature	T _{J max}	–	150	°C
Conservation temperature	T _{stg}	–	–40~125	°C

Recommended Operating Conditions (T_a=25°C)

Item	Symbol	Condition	Rated value	Unit
Source voltage -1	V _{CC1}	With signal	10~45	V
Source voltage -2	V _{CC2}	With signal	5.0±5%	V
Input voltage	V _{IH}	–	0~V _{CC2}	V
Phase current	I _{OH}	Duty 50%	3	A
Clock frequency	Clock	–	DC~50	kHz
Withstand voltage of phase driver	V _{DSS}	–	100	V

Dimensions [Unit: mm(inch)]

Pin No.	Terminal name	Pin No.	Terminal name
1.	\bar{B}	12.	V _{CC2}
2.	B	13.	V _{CC2}
3.	P.GND A	14.	Clock
4.	P.GND B	15.	CW/CCW
5.	\bar{A}	16.	Reset
6.	A	17.	Return
7.	V _{CC2}	18.	Enable
8.	V _{ref}	19.	M ₀₁
9.	Mode 1	20.	M ₀₁
10.	Mode 2	21.	M ₀₂
11.	Mode 3	22.	GND

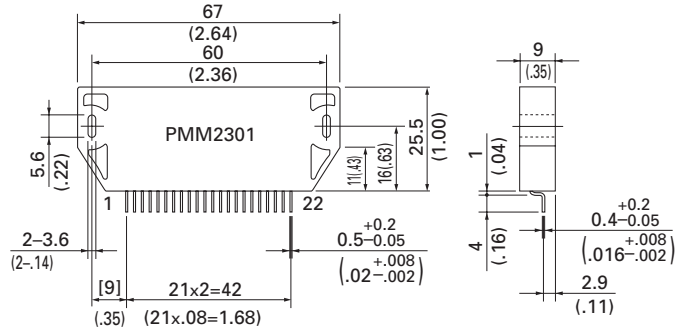

Each Terminal Function

Terminal name	Function	Functioning condition															
V _{ref}	Motor current setting input	-															
Clock	Motor driving pulse input	Mode 3="H" level: Operates at rising edge Mode 3="L" level: Operates at rising and falling edges															
CW/CCW	Motor rotation direction setting input	"H" level= CW rotation "L" level= CCW rotation															
Reset	System reset	Reset="L"															
Return	Forced return to phase origin	Forced shift to the origin of the present energization phase with Return="H".															
Enable	Power OFF input	Enable="L"															
M ₀₁	Phase origin monitor output	"L" level output at the phase origin.															
M ₀₁ , M ₀₂	Monitor output on phase energization status	Outputs level signal on the present phase energization status.															
		<table border="1"> <thead> <tr> <th>Phase coordinate</th> <th>A phase</th> <th>B phase</th> <th>\bar{A} phase</th> <th>\bar{B} phase</th> </tr> </thead> <tbody> <tr> <td>M₀₁</td> <td>H</td> <td>L</td> <td>L</td> <td>H</td> </tr> <tr> <td>M₀₂</td> <td>L</td> <td>H</td> <td>L</td> <td>H</td> </tr> </tbody> </table>	Phase coordinate	A phase	B phase	\bar{A} phase	\bar{B} phase	M ₀₁	H	L	L	H	M ₀₂	L	H	L	H
Phase coordinate	A phase	B phase	\bar{A} phase	\bar{B} phase													
M ₀₁	H	L	L	H													
M ₀₂	L	H	L	H													

Energization Mode Table

Input condition			Energization mode	1 step angle (degree)	Number of basic angle division
Mode 1	Mode 2	Mode 3			
L	L	H	2EX	1.8	1/1
H	L	H	1-2EX	0.9	1/2
L	H	H	W1-2EX	0.45	1/4
H	H	H	2W1-2EX	0.225	1/8
H	H	L	4W1-2EX	0.1125	1/16

- Conditioned on the Mode 3=L, one pulse operation is performed at every rising and falling edge of the clock pulse. Accordingly, the operation becomes unstable if the driving pulse duty ratio deviates from 50%.

Electrical Characteristics (Tc=25°C, Vcc1=24V, Vcc2=5V)

Item	Symbol	Condition	Rating			Unit
			MIN.	Standard	MAX.	
Vcc2 Power current	Icco	Enable="L"	-	4.5	15	mA
Effective output current	I _{o ave}	Each phase R/L=3.5Ω/3.8mH Vref=0.6V	0.45	0.50	0.55	A
Forward direction voltage of FET diode	V _{df}	I _f =1A	-	1.2	1.8	V
Output saturating voltage	V _{sat}	RL=7.5Ω (I≒3.0A)	-	1.4	2.6	V
"H" level input voltage	V _{IH}	9~11,14~18 pins	4.0	-	-	V
"L" level input voltage	V _{IL}	9~11,14~18 pins	-	-	1.0	V
Input current	I _{IL}	9~11,14~18 pins=GND level Pull-up resistor 20kΩ	125	250	510	μA
Vref input voltage	V _r	8-pin	0	-	Vcc2/2	V
Vref input current	I _r	8-pin	-	1	-	μA
"H" level output voltage	V _{OH}	19~21 pins I=3mA I=-3mA	2.4	-	-	V
"L" level output voltage	V _{OL}	19~21 pins I=3mA	-	-	0.4	V
M _{0i} ,M ₀₁ ,M ₀₂		I=3mA				
PWM frequency	F _c	-	37	47	57	kHz

Example of Application Circuit

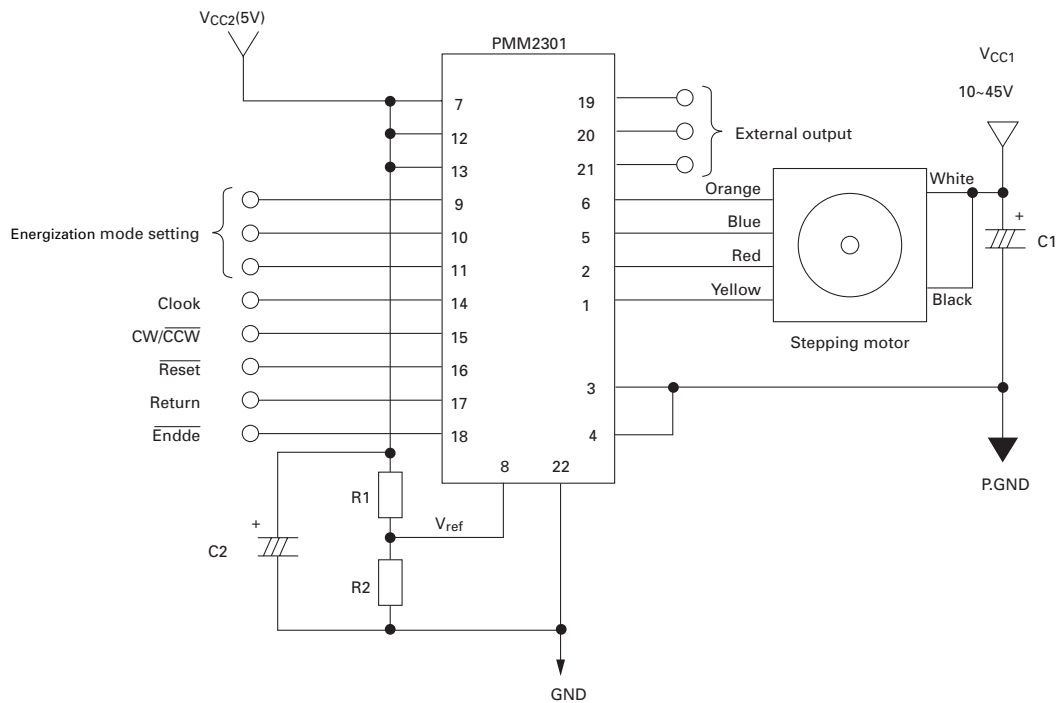

● Recommended circuit constants

C1	C2
100μF OR OVER	10μF

- Determine on the R1 and R2 constants based on the Vref voltage calculated from the following formula.
 $V_{ref}(V) = \text{Motor current adjusted value (A/phase)} \times 0.6$

PMM8713PT

PMM2101

PMM2301

■ Precautions For Adoption

Cautions

Cautions of possible occurrence of a minor or medium injury or a material damage, and even a serious result according to a situation, unless the cautions in the right are duly observed. Be sure to strictly observe the cautions in the right.

Cautions

- Read the instruction manual carefully in order to learn how to use the unit correctly.
- Do not use the unit for the following equipment:
 - (a) Medical equipment which directly affects human lives
 - (b) Equipment which has a significant impact on society or the public
- Do not use the unit in an environment with vibration, such as on a vehicle or ship, or while it is being transported.
- Do not remodel or machine the unit.
- Do not use the unit where it could be exposed to dust, corrosive gas, inflammable gas, salt, or water.

SANYO DENKI CO., LTD.

1-15-1, Kita-otsuka Toshima-ku Tokyo 170-8451, JAPAN

<http://www.sanyodenki.com>

(North America area) Phone: +81 3 3917 2223
(Europe area) Phone: +81 3 3917 5157
(Asia area) Phone: +81 3 3917 2814

TAIWAN BRANCH

Room 401, 4F, No.96, Chung Shan N, Rd., Sec.2, Taipei 104, Taiwan, R.O.C.

Phone:+886 2 2511 3938

HONG KONG BRANCH

1109, 11F New East Ocean Centre, 9 Science Museum Road, TST East, Kowloon, Hong Kong

Phone:+852 2312 6250

SHANGHAI BRANCH

Room 2116, Bldg B, FAR EAST INTERNATIONAL PLAZA, No.317 Xianxia Rd., Shanghai 200051, China

Phone:+86 21 6235 1107

SANYO DENKI AMERICA, INC.

468 Amapola Avenue Torrance, California 90501 U.S.A.

Phone:+1 310 783 5400

SANYO DENKI EUROPE SA.

P.A. PARIS NORD II 48 Allee des Erables-VILLEPINTE BP.50286 F-95958 ROISSY CDG CEDEX France

Phone:+33 1 48 63 26 61