

## LOW-DISTORTION, HIGH SLEW-RATE CURRENT FEEDBACK AMPLIFIERS

### FEATURES

- **Unity Gain Bandwidth: 300 MHz**
- **0.1 dB Bandwidth: 120 MHz (G=2)**
- **High Slew Rate: 7000 V/ $\mu$ s**
- **HD3 at 10 MHz: -81 dBc (G=2,  $R_L = 150 \Omega$ )**
- **High Output Current:  $\pm 145$  mA into  $50 \Omega$**
- **Power Supply Voltage Range:  $\pm 5$  V to  $\pm 15$  V**

### APPLICATIONS

- **High-Speed Signal Processing**
- **Test and Measurement Systems**
- **VDSL Line Driver**
- **High-Voltage ADC Preamplifier**
- **Video Line Driver**

### DESCRIPTION

The THS3061 (single) and THS3062 (dual) are high-voltage, high slew-rate current feedback amplifiers utilizing Texas Instruments BICOM-1 process. Designed for low-distortion with a high slew rate of 7000 V/ $\mu$ s, the THS306x amplifiers are ideally suited for applications requiring large, linear output signals such as video line drivers and VDSL line drivers.

The THS3061 and THS3062 provide well-regulated ac performance characteristics with power supplies ranging from  $\pm 5$ -V operation up to  $\pm 15$ -V supplies. Most notable, the 0.1-dB flat bandwidth is exceedingly high, reaching beyond 100 MHz, and the THS306x has less than 0.3 dB of peaking in the frequency response when configured in unity gain. The unity gain bandwidth of 300 MHz allows for excellent distortion characteristics at 10 MHz. The flexibility of the current feedback design allows for a 220-MHz, -3-dB bandwidth in a gain of 10 indicating excellent performance even at high gains.

The THS306x consumes 8.3-mA per channel quiescent current at room temperature and has the capability of producing up to  $\pm 145$  mA of output current. The THS3061 is packaged in an 8-pin SOIC and an 8-pin MSOP with PowerPAD™. The THS3062 is available in an 8-pin SOIC with PowerPAD and an 8-pin MSP with PowerPAD.

### RELATED DEVICES AND DESCRIPTIONS

THS3001	Low Distortion Current Feedback Amplifier
THS3112	Dual Current Feedback Amplifier With 175 mA Drive
THS3122	Dual Current Feedback Amplifier With 350 mA Drive
OPA691	Wideband Current Feedback Amplifier With 350 mA Drive

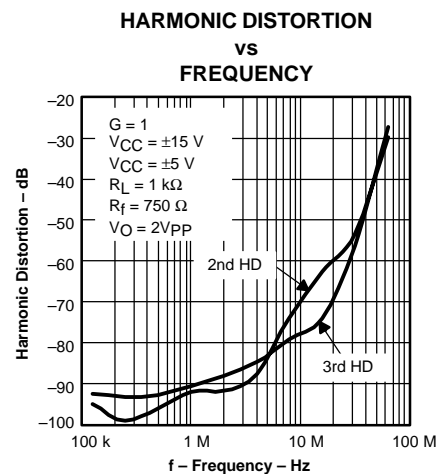
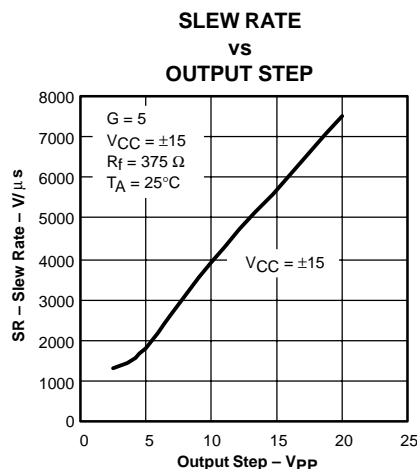

Please be aware that an important notice concerning availability, standard warranty, and use in critical applications of Texas Instruments semiconductor products and disclaimers thereto appears at the end of this data sheet.

PowerPAD is a trademark of Texas Instruments.

**ABSOLUTE MAXIMUM RATINGS**

over operating free-air temperature range unless otherwise noted<sup>(1)</sup>

	UNIT
Supply voltage, $V_{S\pm}$	16.5 V
Input voltage, $V_I$	$\pm V_S$
Output current, $I_O$	200 mA
Differential input voltage, $V_{ID}$	$\pm 3$ V
Continuous power dissipation	See Dissipation Rating Table
Maximum junction temperature, $T_J$	150°C
Operating free-air temperature range, $T_A$	-40°C to 85°C
Storage temperature range, $T_{stg}$	-65°C to 150°C
Lead temperature 1,6 mm (1/16 inch) from case for 10 seconds	300°C

- (1) Stresses above these ratings may cause permanent damage. Exposure to absolute maximum conditions for extended periods may degrade device reliability. These are stress ratings only, and functional operation of the device at these or any other conditions beyond those specified is not implied.
- (2) The THS306x may incorporate a PowerPAD on the underside of the chip. This acts as a heatsink and must be connected to a thermally dissipative plane for proper power dissipation. Failure to do so may result in exceeding the maximum junction temperature which could permanently damage the device. See TI technical brief SLMA002 for more information about utilizing the PowerPAD thermally enhanced package.



This integrated circuit can be damaged by ESD. Texas Instruments recommends that all integrated circuits be handled with appropriate precautions. Failure to observe proper handling and installation procedures can cause damage.

ESD damage can range from subtle performance degradation to complete device failure. Precision integrated circuits may be more susceptible to damage because very small parametric changes could cause the device not to meet its published specifications.

**PACKAGE DISSIPATION RATINGS**

PACKAGE	$\theta_{JC}$ (°C/W)	$\theta_{JA}$ (°C/W)	POWER RATING ( $T_J = 125^\circ\text{C}$ )	
			$T_A \leq 25^\circ\text{C}$	$T_A = 85^\circ\text{C}$
D(8 pin) <sup>(1)</sup>	38.3	95	1.05 W	0.42 W
DDA (8 pin)	9.2	45.8	2.18 W	0.87 W
DGN (8 pin) <sup>(2)</sup>	4.7	58.4	1.71 W	0.68 W

- (1) This data was taken using the JEDEC High-K test PCB. For the JEDEC Low-K test PCB,  $\theta_{JA}$  is 167°C/W with power rating at  $T_A = 25^\circ\text{C}$  of 0.6 W.
- (2) This data was taken using 2 oz. trace and copper pad that is soldered directly to a 3 in. x 3 in. PCB.

**RECOMMENDED OPERATING CONDITIONS**

		MIN	MAX	UNIT
Supply voltage	Dual supply	$\pm 5$	$\pm 15$	V
	Single supply	10	30	
Operating free-air temperature, $T_A$		-40	85	°C

**PACKAGE/ORDERING INFORMATION**

NUMBER OF CHANNELS	ORDERABLE PACKAGE AND NUMBER (OPERATING RANGE FROM -40°C TO 85°C)			
	PLASTIC SOIC-8 <sup>(1)</sup> (D)	PLASTIC SOIC-8 <sup>(1)</sup> PowerPAD (DDA)	PLASTIC MSOP-8 <sup>(1)</sup> PowerPAD (DGN)	PACKAGE MARKING
1	THS3061D	—	THS3061DGN	BIB
2	THS3062D	THS3062DDA	THS3062DGN	BIC

- (1) This package is available taped and reeled. To order this packaging option, add an R suffix to the part number (e.g., THS3062DGNR).

**PIN ASSIGNMENTS**

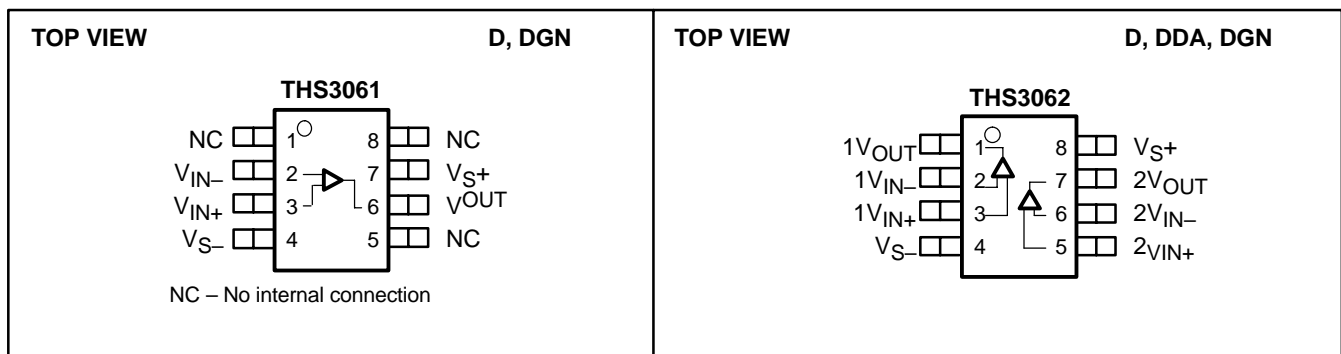

**ELECTRICAL CHARACTERISTICS**
 $V_S = \pm 15\text{ V}$ ;  $R_f = 560\ \Omega$ ,  $R_L = 150\ \Omega$ , and  $G = +2$  unless otherwise noted

PARAMETER	TEST CONDITIONS	THS3061, THS3062					
		TYP	OVER TEMPERATURE				MIN/TYP/ MAX
		25°C	25°C	0°C to 70°C	-40°C to 85°C	UNITS	
<b>AC PERFORMANCE</b>							
Small-signal bandwidth ( $V_O = 100\text{ mV}_{pp}$ , Peaking < 0.3 dB)	$G = +1$ , $R_f = 750\ \Omega$	300				MHz	Typ
	$G = +2$ , $R_f = 560\ \Omega$	275					
	$G = +5$ , $R_f = 357\ \Omega$	260					
	$G = +10$ , $R_f = 200\ \Omega$	220					
Bandwidth for 0.1 dB flatness	$G = +2$ , $V_O = 100\text{ mV}_{pp}$	120				MHz	Typ
Peaking at a gain of +1	$V_O = 100\text{ mV}_{pp}$	0.3				dB	Typ
Large-signal bandwidth	$G = +2$ , $V_O = 4\text{ V}_{pp}$	120				MHz	Typ
Slew rate (25% to 75% level)	$G = +5$ , 20 V Step	7000				V/ $\mu\text{s}$	Typ
	$G = +2$ , 10 V Step	5700					
Rise and fall time	$G = +2$ , $V_O = 10\text{ V}$ Step	1				ns	Typ
Settling time to 0.1% 0.01%	$G = -2$ , $V_O = 2\text{ V}$ Step	30				ns	Typ
	$G = -2$ , $V_O = 2\text{ V}$ Step	125				ns	Typ
Harmonic distortion	$G = +2$ , $f = 10\text{ MHz}$ , $V_O = 2\text{ V}_{pp}$						
2 <sup>nd</sup> harmonic	$R_L = 150\ \Omega$	-78				dBc	Typ
	$R_L = 1\text{ k}\Omega$	-73					
3 <sup>rd</sup> harmonic	$R_L = 150\ \Omega$	-81				dBc	Typ
	$R_L = 1\text{ k}\Omega$	-82					
3 <sup>rd</sup> order intermodulation distortion	$G = +2$ , $f_c = 10\text{ MHz}$ , $V_O = 2\text{ V}_{pp}$ (envelope) $\Delta f = 200\text{ kHz}$	-93				dBc	Typ
Input voltage noise	$f > 10\text{ kHz}$	2.6				nV/ $\sqrt{\text{Hz}}$	Typ
Input current noise (noninverting)	$f > 10\text{ kHz}$	20				pA/ $\sqrt{\text{Hz}}$	Typ
Input current noise (inverting)	$f > 10\text{ kHz}$	36				pA/ $\sqrt{\text{Hz}}$	Typ
Differential gain (NTSC, PAL)	$G = +2$ , $R_L = 150\ \Omega$	0.02%					Typ
Differential phase (NTSC, PAL)	$G = +2$ , $R_L = 150\ \Omega$	0.01°					Typ
<b>DC PERFORMANCE</b>							
Open-loop transimpedance gain	$V_O = 0\text{ V}$ , $R_L = 1\text{ k}\Omega$	1	0.7	0.6	0.6	M $\Omega$	Min
Input offset voltage	$V_{CM} = 0\text{ V}$	$\pm 0.7$	$\pm 3.5$	$\pm 4.4$	$\pm 4.5$	mV	Max
Average offset voltage drift	$V_{CM} = 0\text{ V}$			$\pm 10$	$\pm 10$	$\mu\text{V}/^\circ\text{C}$	Typ
Input bias current (inverting)	$V_{CM} = 0\text{ V}$	$\pm 2.0$	$\pm 20$	$\pm 32$	$\pm 35$	$\mu\text{A}$	Max
Average bias current drift (-)	$V_{CM} = 0\text{ V}$			$\pm 25$	$\pm 30$	nA/ $^\circ\text{C}$	Typ
Input bias current (noninverting)	$V_{CM} = 0\text{ V}$	$\pm 6.0$	$\pm 25$	$\pm 38$	$\pm 40$	$\mu\text{A}$	Max
Average bias current drift (+)	$V_{CM} = 0\text{ V}$			$\pm 45$	$\pm 50$	nA/ $^\circ\text{C}$	Typ
<b>INPUT</b>							
Common-mode input range		$\pm 13.9$	$\pm 13.1$	$\pm 13.1$	$\pm 13.1$	V	Min
Common-mode rejection ratio	$V_{CM} = \pm 0.5\text{ V}$	72	60	58	58	dB	Min
Input resistance	Noninverting	518				k $\Omega$	Typ
	Inverting	71				$\Omega$	Typ
Input capacitance	Noninverting	1				pF	Typ

**ELECTRICAL CHARACTERISTICS (continued)**

$V_S = \pm 15$  V:  $R_f = 560 \Omega$ ,  $R_L = 150 \Omega$ , and  $G = +2$  unless otherwise noted

PARAMETER	TEST CONDITIONS	THS3061, THS3062					
		TYP	OVER TEMPERATURE				MIN/TYP/ MAX
		25°C	25°C	0°C to 70°C	-40°C to 85°C	UNITS	
<b>OUTPUT</b>							
Voltage output swing	$R_L = 1 \text{ k}\Omega$	$\pm 13.7$	$\pm 13.4$	$\pm 13.4$	$\pm 13.3$	V	Min
	$R_L = 150 \Omega$	$\pm 13$	$\pm 12.6$	$\pm 12.4$	$\pm 12.3$		
Current output, sourcing	$R_L = 50 \Omega$	145	140	135	130	mA	Min
Current output, sinking	$R_L = 50 \Omega$	-145	-140	-135	-130	mA	Min
Closed-loop output impedance	$G = +1$ , $f = 1 \text{ MHz}$	0.1				$\Omega$	Typ
<b>POWER SUPPLY</b>							
Specified operating voltage		$\pm 15$				V	Typ
Maximum operating voltage			$\pm 16.5$	$\pm 16.5$	$\pm 16.5$	V	Max
Maximum quiescent current/channel		8.3	10	11.7	12	mA	Max
Minimum quiescent current/channel		8.3	6.1	6	6	mA	Min
Power supply rejection (+PSRR)	$V_{S+} = 14.50 \text{ V to } 15.50 \text{ V}$	76	65	63	63	dB	Min
Power supply rejection (-PSRR)	$V_{S-} = -14.50 \text{ V to } -15.50 \text{ V}$	74	65	63	63	dB	Min

**ELECTRICAL CHARACTERISTICS**
 $V_S = \pm 5\text{ V}$ ;  $R_f = 560\ \Omega$ ,  $R_L = 150\ \Omega$ , and  $G = +2$  unless otherwise noted

PARAMETER	TEST CONDITIONS	THS3061, THS3062					
		TYP	OVER TEMPERATURE				MIN/TYP/ MAX
		25°C	25°C	0°C to 70°C	-40°C to 85°C	UNITS	
<b>AC PERFORMANCE</b>							
Small-signal bandwidth ( $V_O = 100\text{ mV}_{pp}$ , peaking < 0.3 dB)	$G = +1$ , $R_f = 750\ \Omega$	275				MHz	Typ
	$G = +2$ , $R_f = 560\ \Omega$	250					
	$G = +5$ , $R_f = 383\ \Omega$	230					
	$G = +10$ , $R_f = 200\ \Omega$	210					
Bandwidth for 0.1 dB flatness	$G = +2$ , $V_O = 100\text{ mV}_{pp}$	100				MHz	Typ
Peaking at a gain of +1	$V_O = 100\text{ mV}_{pp}$	< 0.3				dB	Typ
Large-signal bandwidth	$G = +2$ , $V_O = 4\text{ V}_{pp}$	100				MHz	Typ
Slew rate (25% to 75% level)	$G = +1$ , 5 V Step, $R_f = 750\ \Omega$	2700				V/ $\mu$ s	Typ
	$G = +5$ , 5 V Step, $R_f = 357\ \Omega$	1300					
Rise and fall time	$G = +2$ , $V_O = 5\text{ V}$ Step	2				ns	Typ
Settling time to 0.1% 0.01%	$G = -2$ , $V_O = 2\text{ V}$ Step	20				ns	Typ
	$G = -2$ , $V_O = 2\text{ V}$ Step	160					
Harmonic distortion	$G = +2$ , $f = 10\text{ MHz}$ , $V_O = 2\text{ V}_{pp}$						
2 <sup>nd</sup> harmonic	$R_L = 150\ \Omega$	-76				dBc	Typ
	$R_L = 1\text{ k}\Omega$	-70					
3 <sup>rd</sup> harmonic	$R_L = 150\ \Omega$	-79				dBc	Typ
	$R_L = 1\text{ k}\Omega$	-77					
3 <sup>rd</sup> order intermodulation distortion	$G = +2$ , $f_c = 10\text{ MHz}$ , $V_O = 2\text{ V}_{pp}$ (envelope) $\Delta f = 200\text{ kHz}$	-91				dBc	Typ
Input voltage noise	$f > 10\text{ kHz}$	2.6				nV/ $\sqrt{\text{Hz}}$	Typ
Input current noise (noninverting)	$f > 10\text{ kHz}$	20				pA/ $\sqrt{\text{Hz}}$	Typ
Input current noise (inverting)	$f > 10\text{ kHz}$	36				pA/ $\sqrt{\text{Hz}}$	Typ
Differential gain (NTSC, PAL)	$G = +2$ , $R_L = 150\ \Omega$	0.025%					Typ
Differential phase (NTSC, PAL)	$G = +2$ , $R_L = 150\ \Omega$	0.01°					Typ
<b>DC PERFORMANCE</b>							
Open-loop transimpedance gain	$V_O = 0\text{ V}$ , $R_L = 1\text{ k}\Omega$	0.8	0.6	0.5	0.5	M $\Omega$	Min
Input offset voltage	$V_{CM} = 0\text{ V}$	$\pm 0.3$	$\pm 3.5$	$\pm 4.4$	$\pm 4.5$	mV	Max
Average offset voltage drift	$V_{CM} = 0\text{ V}$			$\pm 9$	$\pm 9$	$\mu\text{V}/^\circ\text{C}$	Typ
Input bias current (inverting)	$V_{CM} = 0\text{ V}$	$\pm 2.0$	$\pm 20$	$\pm 32$	$\pm 35$	$\mu\text{A}$	Max
Average bias current drift (-)	$V_{CM} = 0\text{ V}$			$\pm 20$	$\pm 25$	nA/ $^\circ\text{C}$	Typ
Input bias current (noninverting)	$V_{CM} = 0\text{ V}$	$\pm 6.0$	$\pm 25$	$\pm 38$	$\pm 40$	$\mu\text{A}$	Max
Average bias current drift (+)	$V_{CM} = 0\text{ V}$			$\pm 30$	$\pm 35$	nA/ $^\circ\text{C}$	Typ
<b>INPUT</b>							
Common-mode input range		$\pm 3.9$	$\pm 3.1$	$\pm 3.1$	$\pm 3.1$	V	Min
Common-mode rejection ratio	$V_{CM} = \pm 0.5\text{ V}$	70	60	58	58	dB	Min
Input resistance	Noninverting	518				k $\Omega$	Typ
	Inverting	71				$\Omega$	Typ
Input capacitance	Noninverting	1				pF	Typ

**ELECTRICAL CHARACTERISTICS (continued)**

$V_S = \pm 5\text{ V}$ :  $R_f = 560\ \Omega$ ,  $R_L = 150\ \Omega$ , and  $G = +2$  unless otherwise noted

PARAMETER	TEST CONDITIONS	THS3061, THS3062					
		TYP	OVER TEMPERATURE				MIN/TYP/ MAX
		25°C	25°C	0°C to 70°C	-40°C to 85°C	UNITS	
<b>OUTPUT</b>							
Voltage output swing	$R_L = 1\text{ k}\Omega$	$\pm 4.1$	$\pm 3.8$	$\pm 3.8$	$\pm 3.7$	V	Min
	$R_L = 150\ \Omega$	$\pm 4.0$	$\pm 3.6$	$\pm 3.6$	$\pm 3.5$		
Current output, sourcing	$R_L = 50\ \Omega$	63	61	60	59	mA	Min
Current output, sinking	$R_L = 50\ \Omega$	-63	-61	-60	-59	mA	Min
Closed-loop output impedance	$G = +1$ , $f = 1\text{ MHz}$	0.1				$\Omega$	Typ
<b>POWER SUPPLY</b>							
Specified operating voltage		$\pm 5$				V	Typ
Minimum operating voltage			$\pm 4.5$	$\pm 4.5$	$\pm 4.5$	V	Min
Maximum quiescent current		6.3	8.0	9.2	9.5	mA	Max
Minimum quiescent current		6.3	5.0	4.7	4.6	mA	Min
Power supply rejection (+PSRR)	$V_{S+} = 4.50\text{ V to } 5.50\text{ V}$	73	65	63	63	dB	Min
Power supply rejection (-PSRR)	$V_{S-} = -4.50\text{ V to } -5.50\text{ V}$	75	65	63	63	dB	Min

**PARAMETER MEASUREMENT INFORMATION**

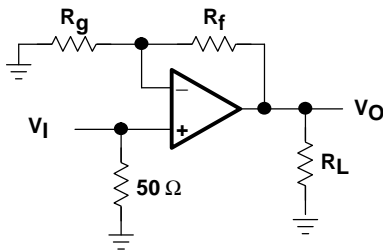

Figure 1. Noninverting Test Circuit

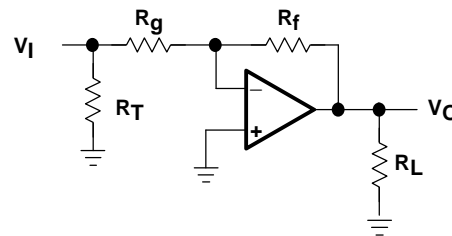

Figure 2. Inverting Test Circuit

## TYPICAL CHARACTERISTICS

### Table of Graphs

		FIGURE
Small signal frequency response		3 – 14
Large signal frequency response		15, 16
Harmonic distortion	vs Frequency	17 – 23
Harmonic distortion	vs Output voltage	24 – 29
Output impedance	vs Frequency	30
Common-mode rejection ratio	vs Frequency	31
Input current noise	vs Frequency	32
Voltage noise density	vs Frequency	33
Power supply rejection ratio	vs Frequency	34
Common-mode rejection ratio (DC)	vs Input common-mode range	35
Supply current	vs Power supply voltage	36, 37
Slew rate	vs Output voltage	38, 39
Slew rate	vs Output step	40
Input offset voltage	vs Output voltage swing	41
Overdrive recovery time		42, 43
Differential gain	vs Number of 150- $\Omega$ loads	44, 45
Differential phase	vs Number of 150- $\Omega$ loads	46, 47

TYPICAL CHARACTERISTICS

SMALL SIGNAL FREQUENCY RESPONSE

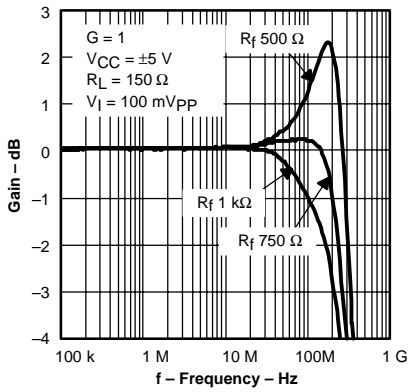

Figure 3

SMALL SIGNAL FREQUENCY RESPONSE

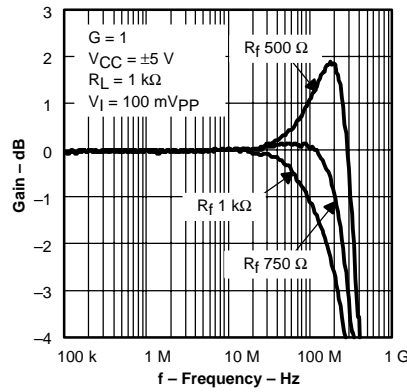

Figure 4

SMALL SIGNAL FREQUENCY RESPONSE

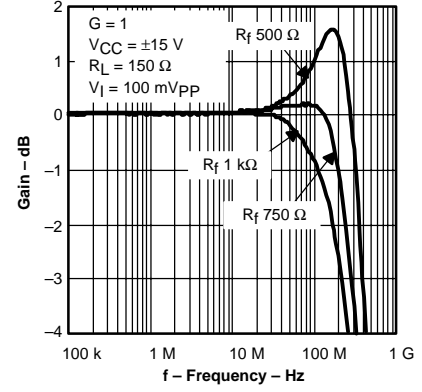

Figure 5

SMALL SIGNAL FREQUENCY RESPONSE

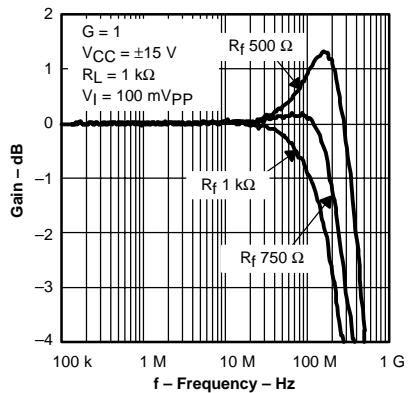

Figure 6

SMALL SIGNAL FREQUENCY RESPONSE

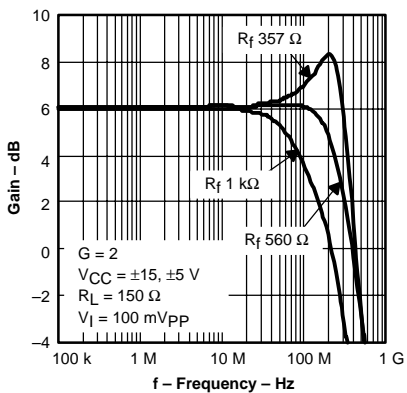

Figure 7

SMALL SIGNAL FREQUENCY RESPONSE

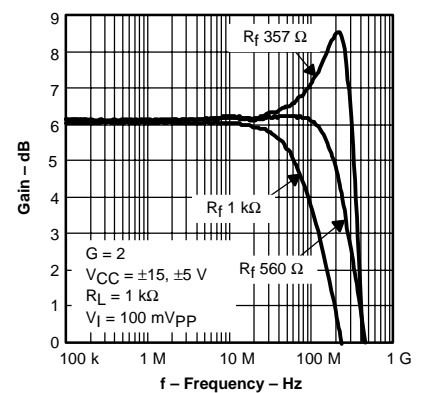

Figure 8

SMALL SIGNAL FREQUENCY RESPONSE

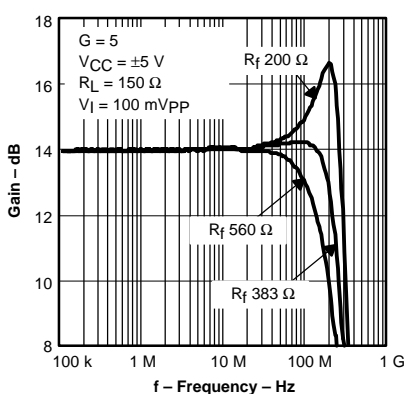

Figure 9

SMALL SIGNAL FREQUENCY RESPONSE

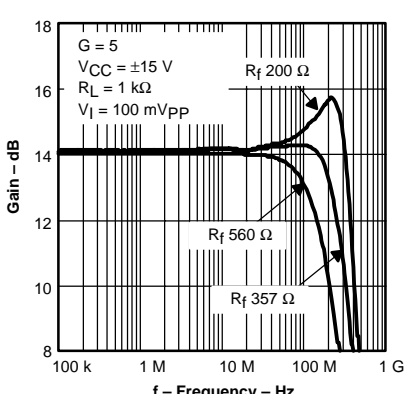

Figure 10

SMALL SIGNAL FREQUENCY RESPONSE

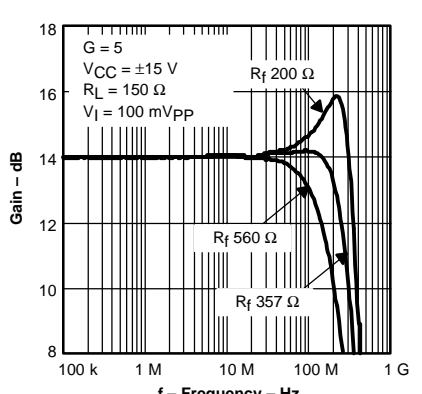

Figure 11



SMALL SIGNAL FREQUENCY RESPONSE

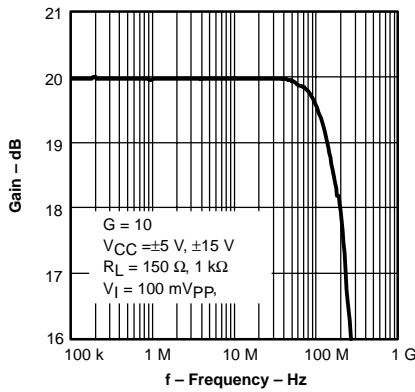

Figure 12

SMALL SIGNAL FREQUENCY RESPONSE

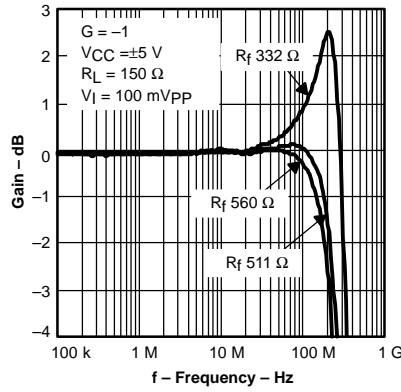

Figure 13

SMALL SIGNAL FREQUENCY RESPONSE

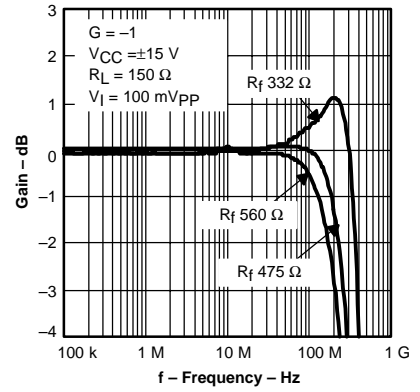

Figure 14

LARGE SIGNAL FREQUENCY RESPONSE

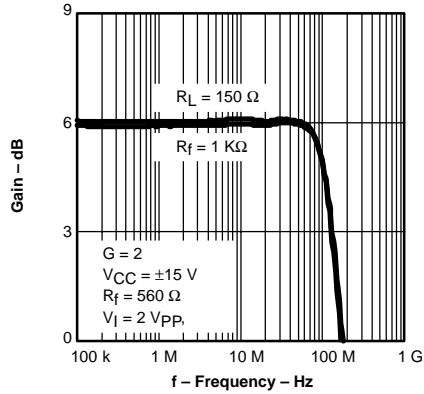

Figure 15

LARGE SIGNAL FREQUENCY RESPONSE

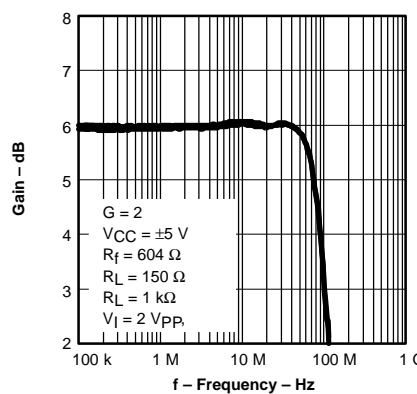

Figure 16

THS3061  
HARMONIC DISTORTION  
vs  
FREQUENCY

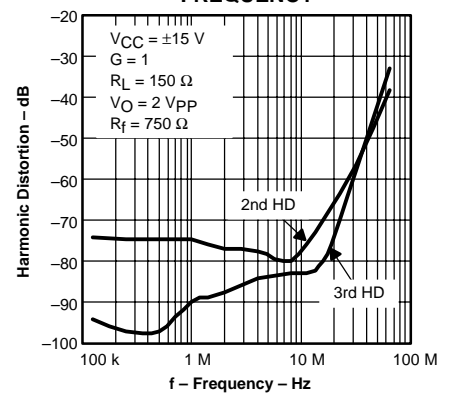

Figure 17

THS3062  
HARMONIC DISTORTION  
vs  
FREQUENCY

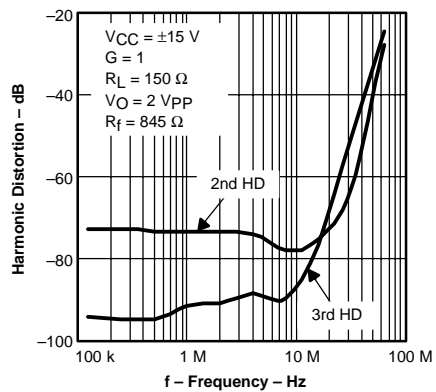

Figure 18

HARMONIC DISTORTION  
vs  
FREQUENCY

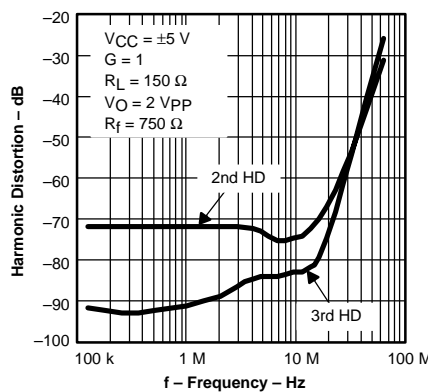

Figure 19

HARMONIC DISTORTION  
vs  
FREQUENCY

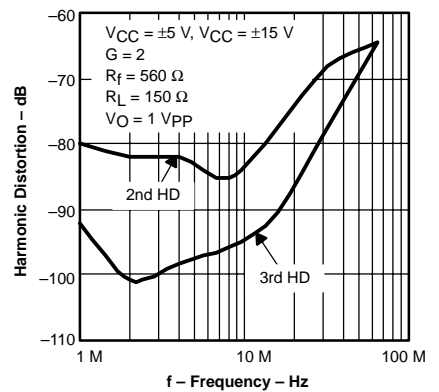

Figure 20

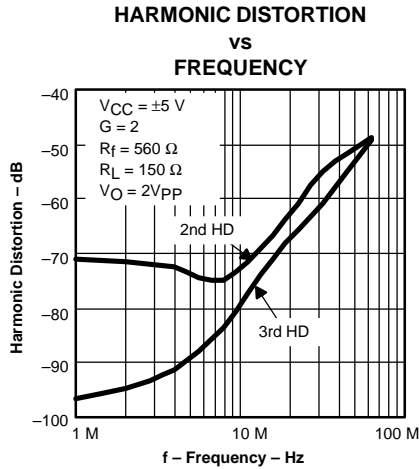

Figure 21

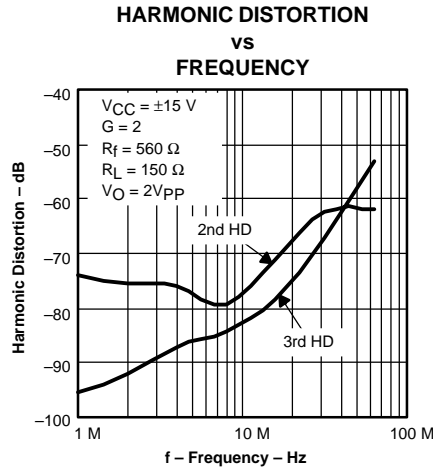

Figure 22

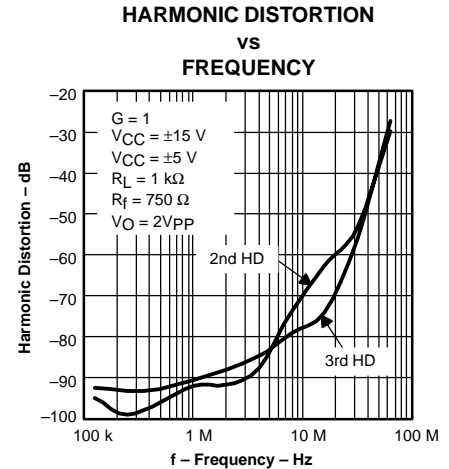

Figure 23

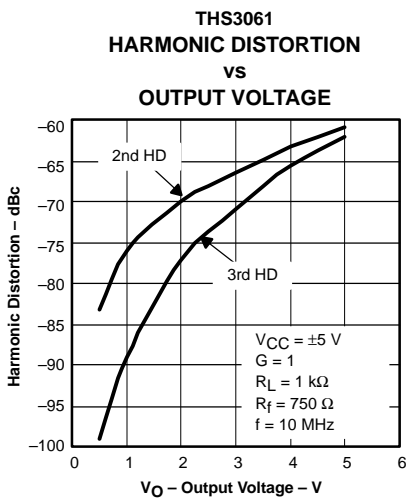

Figure 24

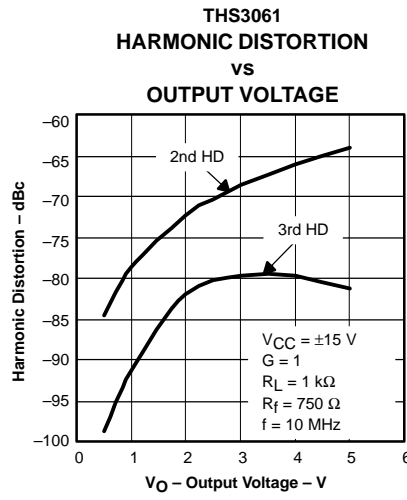

Figure 25

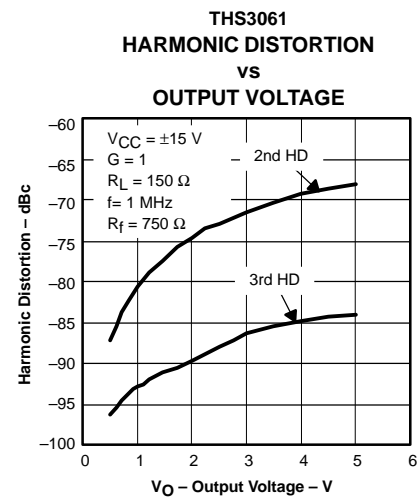

Figure 26

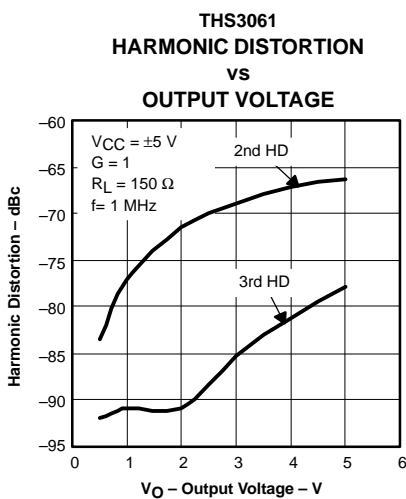

Figure 27

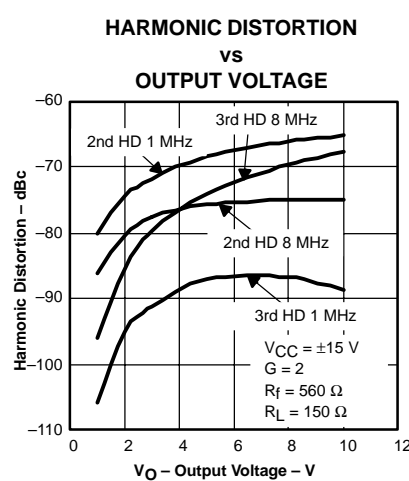

Figure 28

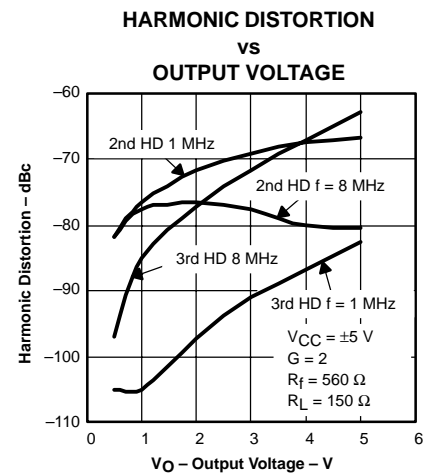

Figure 29

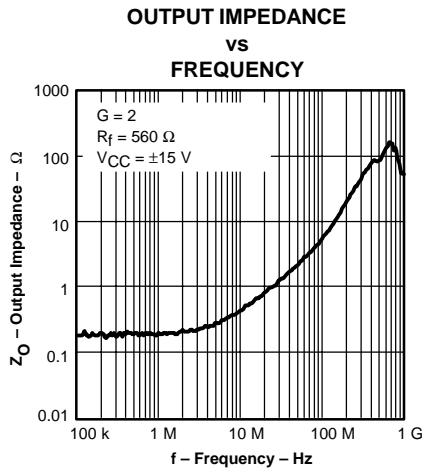

Figure 30

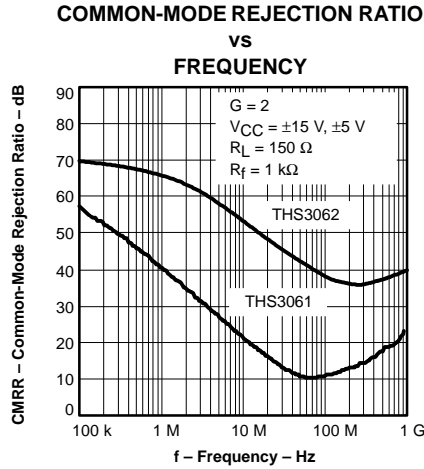

Figure 31

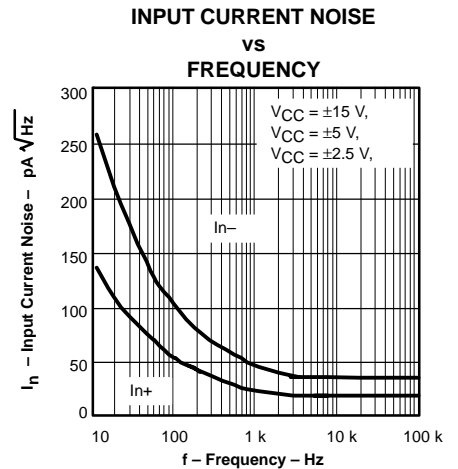

Figure 32

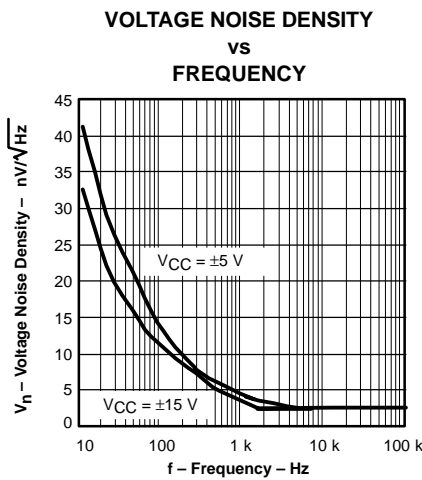

Figure 33

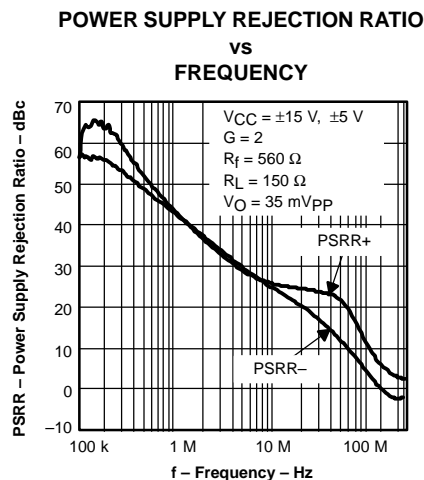

Figure 34

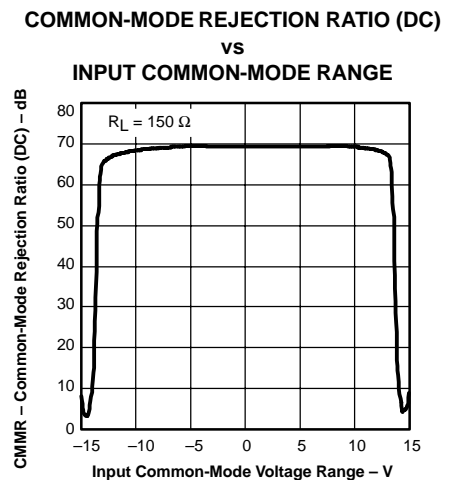

Figure 35

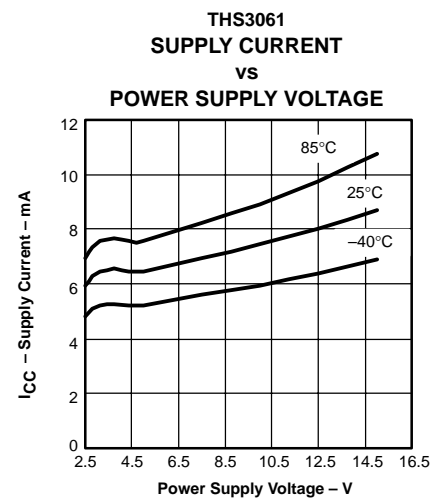

Figure 36

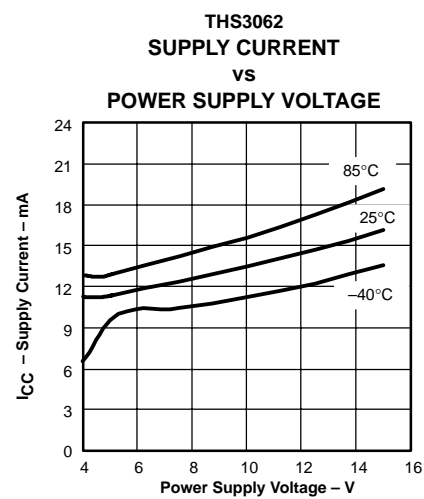

Figure 37

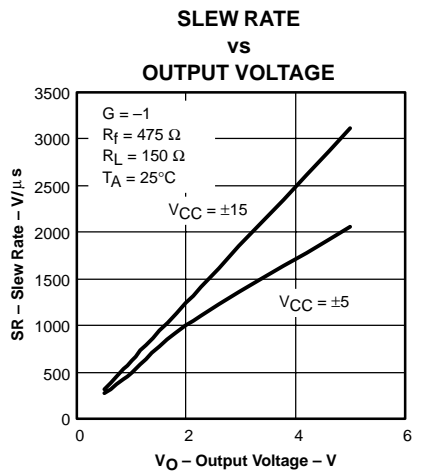

Figure 38

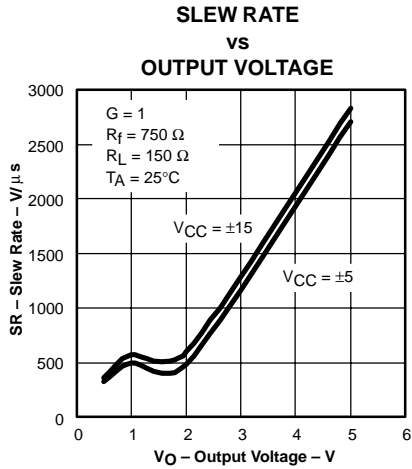

Figure 39

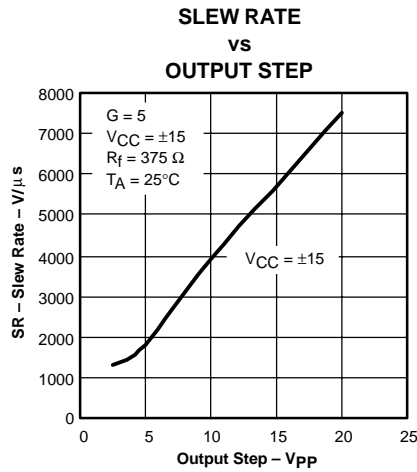

Figure 40

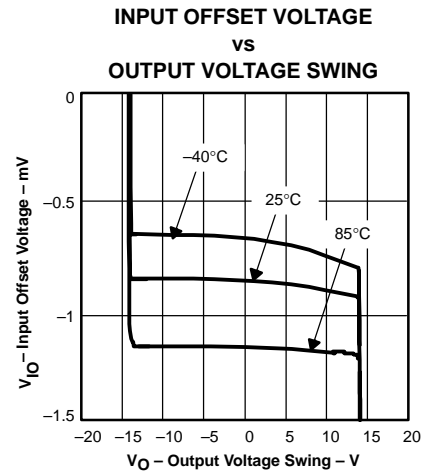

Figure 41

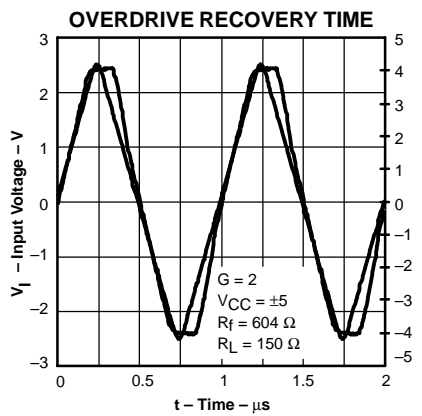

Figure 42

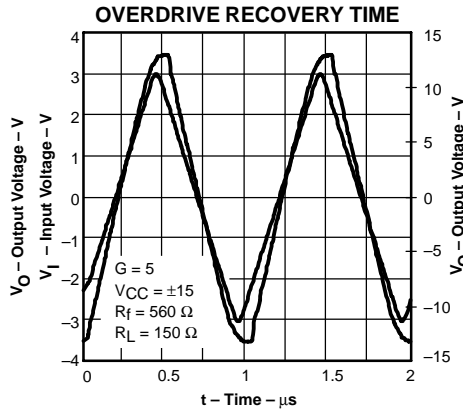

Figure 43

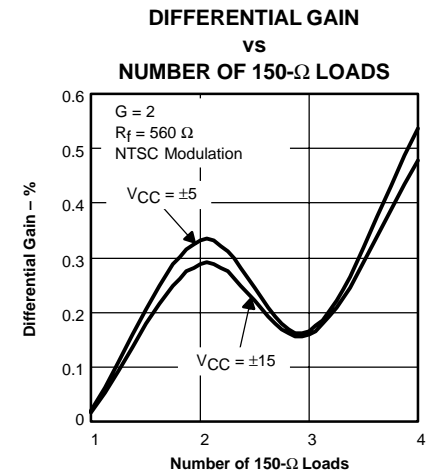

Figure 44

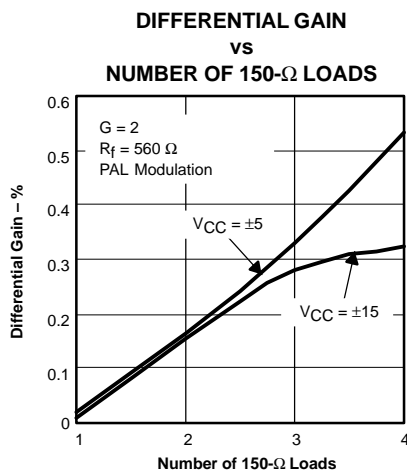

Figure 45

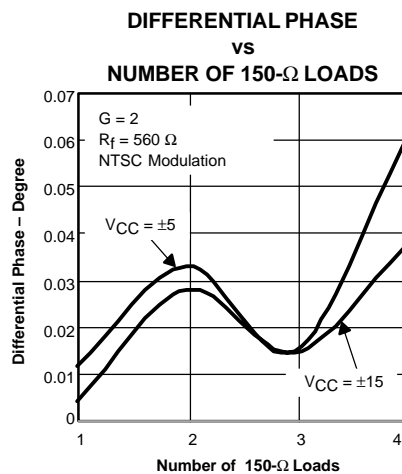

Figure 46

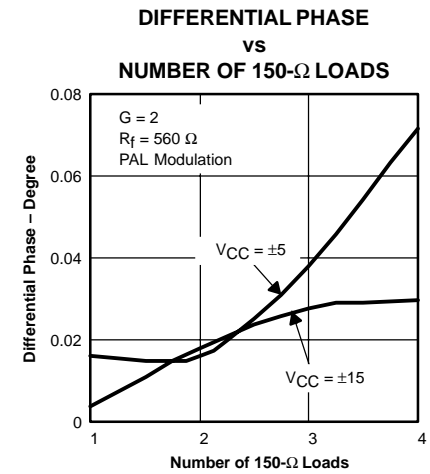

Figure 47

## APPLICATION INFORMATION

### INTRODUCTION

The THS306x is a high-speed, operational amplifier configured in a current-feedback architecture. The device is built using Texas Instruments BiCOM-I process, a 30-V, dielectrically isolated, complementary bipolar process with NPN and PNP transistors possessing  $f_T$ s of several GHz. This configuration implements an exceptionally high-performance amplifier that has a wide bandwidth, high slew rate, fast settling time, and low distortion.

### RECOMMENDED FEEDBACK AND GAIN RESISTOR VALUES

As with all current-feedback amplifiers, the bandwidth of the THS306x is an inversely proportional function of the value of the feedback resistor. The recommended resistors for the optimum frequency response are shown in Table 1. These should be used as a starting point and once optimum values are found, 1% tolerance resistors should be used to maintain frequency response characteristics. For most applications, a feedback resistor value of 750  $\Omega$  is recommended—a good compromise between bandwidth and phase margin that yields a very stable amplifier.

**Table 1. Recommended Resistor Values for Optimum Frequency Response**

GAIN	$R_F$ for $V_{CC} = \pm 15\text{ V}$	$R_F$ for $V_{CC} = \pm 5\text{ V}$
1	750 $\Omega$	750 $\Omega$
2, -1	560 $\Omega$	560 $\Omega$
5	357 $\Omega$	383 $\Omega$
10	200 $\Omega$	200 $\Omega$

As shown in Table 1, to maintain the highest bandwidth with an increasing gain, the feedback resistor is reduced. The advantage of dropping the feedback resistor (and the gain resistor) is the noise of the system is also reduced compared to no reduction of these resistor values, see noise calculations section. Thus, keeping the bandwidth as high as possible maintains very good distortion performance of the amplifier by keeping the excess loop gain as high as possible.

Care must be taken to not drop these values too low. The amplifier's output must drive the feedback resistance (and gain resistance) and may place a burden on the amplifier. The end result is that distortion may actually increase due to the low impedance load presented to the amplifier. Careful management of the amplifier bandwidth and the associated loading effects needs to be examined by the designer for optimum performance.

The THS3061/62 amplifiers exhibit very good distortion performance and bandwidth with the capability of utilizing up to +15 V power supplies. Their excellent current drive capability of up to +145 mA driving into a 50- $\Omega$  load allows for many versatile applications. One application is driving a twisted pair line (i.e. telephone line). Figure 48 shows a simple circuit for driving a twisted pair differentially.

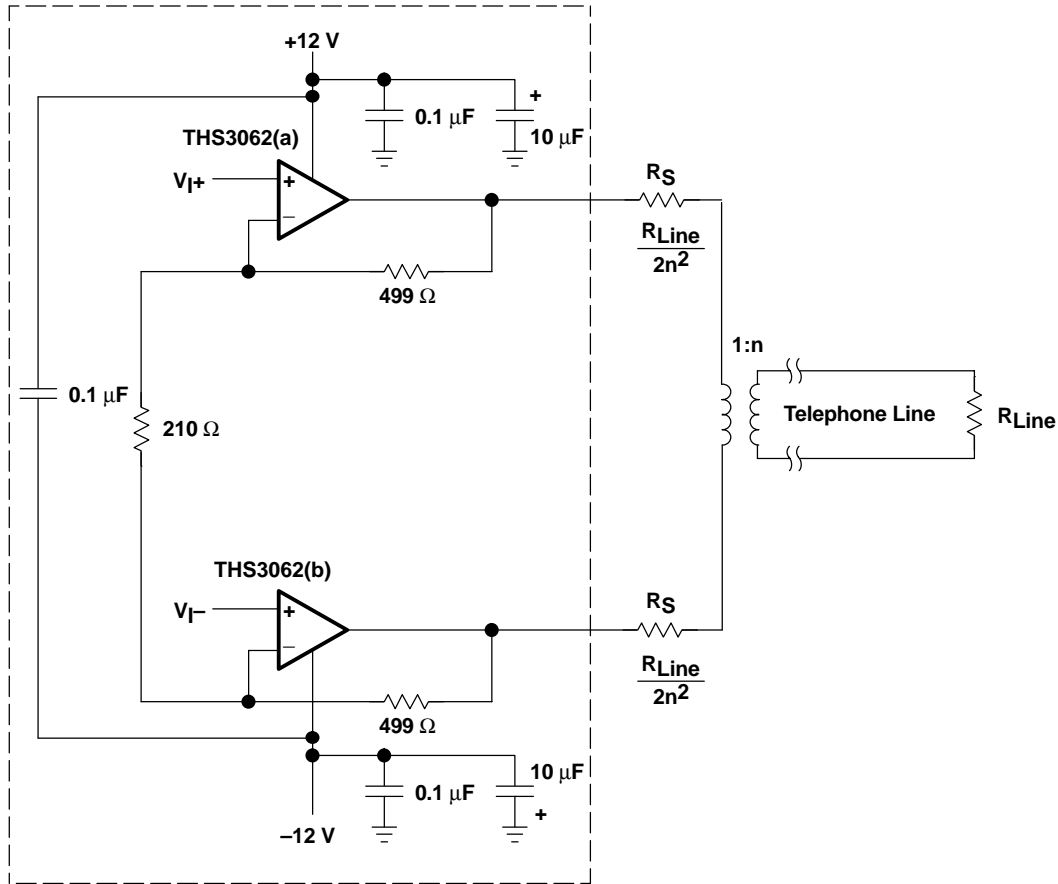

Figure 48. Simple Line Driver With THS3062

Due to the large power supply voltages and the large current drive capability, power dissipation of the amplifier must not be neglected. To have as much power dissipation as possible in a small package, the THS3062 is available only in a MSOP-8 PowerPAD package (DGN) and an even lower thermal impedance SOIC-8 PowerPAD package (DDA). The thermal impedance of a standard SOIC package is too large to allow for useful applications with up to 30 V across the power supply terminals with this dual amplifier. But, the THS3061 – a single amplifier, can be utilized in the standard SOIC package. Again, power dissipation of the amplifier must be carefully examined or else the amplifiers could become too hot and performance can be severely degraded. See the *Power Dissipation and Thermal Considerations* section for more information on thermal management.

## NOISE CALCULATIONS

Noise can cause errors on very small signals. This is especially true for amplifying small signals coming over a transmission line or an antenna. The noise model for current-feedback amplifiers (CFB) is the same as for voltage feedback amplifiers (VFB). The only difference between the two is that CFB amplifiers generally specify different current-noise parameters for each input, while VFB amplifiers usually only specify one noise-current parameter. The noise model is shown in Figure 49. This model includes all of the noise sources as follows:

- $e_n$  = Amplifier internal voltage noise ( $nV/\sqrt{Hz}$ )
- $IN+$  = Noninverting current noise ( $pA/\sqrt{Hz}$ )
- $IN-$  = Inverting current noise ( $pA/\sqrt{Hz}$ )
- $e_{RX}$  = Thermal voltage noise associated with each resistor ( $e_{RX} = 4 kTR_x$ )

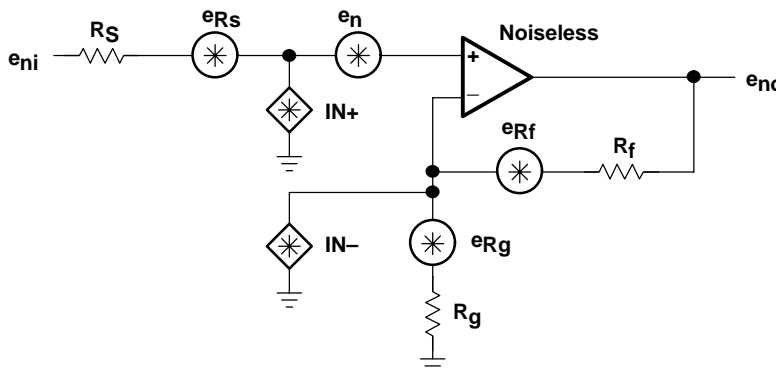

Figure 49. Noise Model

The total equivalent input noise density ( $e_{ni}$ ) is calculated by using the following equation:

$$e_{ni} = \sqrt{(e_n)^2 + (IN+ \times R_S)^2 + (IN- \times (R_f \parallel R_g))^2 + 4kTR_S + 4kT(R_f \parallel R_g)}$$

where

$k$  = Boltzmann's constant =  $1.380658 \times 10^{-23}$

$T$  = Temperature in degrees Kelvin ( $273 + ^\circ C$ )

$R_f \parallel R_g$  = Parallel resistance of  $R_f$  and  $R_g$

To get the equivalent output noise of the amplifier, just multiply the equivalent input noise density ( $e_{ni}$ ) by the overall amplifier gain ( $A_V$ ).

$$e_{no} = e_{ni} A_V = e_{ni} \left( 1 + \frac{R_f}{R_g} \right) \text{ (Noninverting Case)}$$

As the previous equations show, to keep noise at a minimum, small value resistors should be used. As the closed-loop gain is increased (by reducing  $R_f$  and  $R_g$ ), the input noise is reduced considerably because of the parallel resistance term. This leads to the general conclusion that the most dominant noise sources are the source resistor ( $R_S$ ) and the internal amplifier noise voltage ( $e_n$ ). Because noise is summed in a root-mean-squares method, noise sources smaller than 25% of the largest noise source can be effectively ignored. This can greatly simplify the formula and make noise calculations much easier.

## PRINTED-CIRCUIT BOARD LAYOUT TECHNIQUES FOR OPTIMAL PERFORMANCE

Achieving optimum performance with high frequency amplifier-like devices in the THS306x family requires careful attention to board layout parasitic and external component types.

Recommendations that optimize performance include:

- Minimize parasitic capacitance to any ac ground for all of the signal I/O pins. Parasitic capacitance on the output and input pins can cause instability. To reduce unwanted capacitance, a window around the signal I/O pins should be opened in all of the ground and power planes around those pins. Otherwise, ground and power planes should be unbroken elsewhere on the board.
- Minimize the distance (< 0.25") from the power supply pins to high frequency 0.1- $\mu$ F decoupling capacitors. At the device pins, the ground and power plane layout should not be in close proximity to the signal I/O pins. Avoid narrow power and ground traces to minimize inductance between the pins and the decoupling capacitors. The power supply connections should always be decoupled with these capacitors. Larger (6.8  $\mu$ F or more) tantalum decoupling capacitors, effective at lower frequency, should also be used on the main supply pins. These may be placed somewhat farther from the device and may be shared among several devices in the same area of the PC board. The primary goal is to minimize the impedance seen in the differential-current return paths. For driving differential loads with the THS3062, adding a capacitor between the power supply pins improves 2nd order harmonic distortion performance. This also minimizes the current loop formed by the differential drive.
- Careful selection and placement of external components preserve the high frequency performance of the THS306x family. Resistors should be a very low reactance type. Surface-mount resistors work best and allow a tighter overall layout. Again, keep their leads and PC board trace length as short as possible. Never use wirebound type resistors in a high frequency application. Since the output pin and inverting input pins are the most sensitive to parasitic capacitance, always position the feedback and series output resistors, if any, as close as possible to the inverting input pins and output pins. Other network components, such as input termination resistors, should be placed close to the gain-setting resistors. Even with a low parasitic capacitance shunting the external resistors, excessively high resistor values can create significant time constants that can degrade performance. Good axial metal-film or surface-mount resistors have approximately 0.2 pF in shunt with the resistor. For resistor values > 2.0 k $\Omega$ , this parasitic capacitance can add a pole and/or a zero that can effect circuit operation. Keep resistor values as low as possible, consistent with load driving considerations.
- Connections to other wideband devices on the board may be made with short direct traces or through onboard transmission lines. For short connections, consider the trace and the input to the next device as a lumped capacitive load. Relatively wide traces (50 mils to 100 mils) should be used, preferably with ground and power planes opened up around them. Estimate the total capacitive load and determine if isolation resistors on the outputs are necessary. Low parasitic capacitive loads (< 4 pF) may not need an  $R_S$  since the THS306x family is nominally compensated to operate with a 2-pF parasitic load. Higher parasitic capacitive loads without an  $R_S$  are allowed as the signal gain increases (increasing the unloaded phase margin). If a long trace is required, and the 6-dB signal loss intrinsic to a doubly-terminated transmission line is acceptable, implement a matched impedance transmission line using microstrip or stripline techniques (consult an ECL design handbook for microstrip and stripline layout techniques).

A 50- $\Omega$  environment is not necessary onboard, and in fact, a higher impedance environment improves distortion as shown in the distortion versus load plots. With a characteristic board trace impedance based on board material and trace dimensions, a matching series resistor into the trace from the output of the THS306x is used as well as a terminating shunt resistor at the input of the destination device.

Remember also that the terminating impedance is the parallel combination of the shunt resistor and the input impedance of the destination device: this total effective impedance should be set to match the trace impedance. If the 6-dB attenuation of a doubly terminated transmission line is unacceptable, a long trace can be series-terminated at the source end only. Treat the trace as a capacitive load in this case. This does not preserve signal integrity as well as a doubly-terminated line. If the input impedance of the destination device is low, there is some signal attenuation due to the voltage divider formed by the series output into the terminating impedance.

- Socketing a high speed part like the THS306x family is not recommended. The additional lead length and pin-to-pin capacitance introduced by the socket can create an extremely troublesome parasitic network which can make it almost impossible to achieve a smooth, stable frequency response. Best results are obtained by soldering the THS306x family parts directly onto the board.



## PowerPAD DESIGN CONSIDERATIONS

The THS306x family is available in a thermally-enhanced PowerPAD family of packages. These packages are constructed using a downset leadframe upon which the die is mounted [see Figure 50(a) and Figure 50(b)]. This arrangement results in the lead frame being exposed as a thermal pad on the underside of the package [see Figure 50(c)]. Because this thermal pad has direct thermal contact with the die, excellent thermal performance can be achieved by providing a good thermal path away from the thermal pad.

The PowerPAD package allows for both assembly and thermal management in one manufacturing operation. During the surface-mount solder operation (when the leads are being soldered), the thermal pad can also be soldered to a copper area underneath the package. Through the use of thermal paths within this copper area, heat can be conducted away from the package into either a ground plane or other heat dissipating device.

The PowerPAD package represents a breakthrough in combining the small area and ease of assembly of surface mount with the, heretofore, awkward mechanical methods of heatsinking.

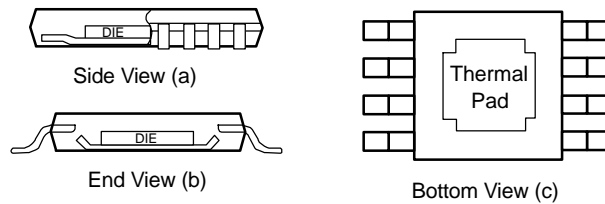

**Figure 50. Views of Thermally Enhanced Package**

Although there are many ways to properly heatsink the PowerPAD package, the following steps illustrate the recommended approach.

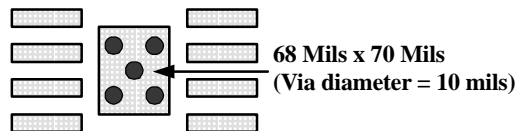

**Figure 51. DGN PowerPAD PCB Etch and Via Pattern**

## PowerPAD PCB LAYOUT CONSIDERATIONS

1. Prepare the PCB with a top side etch pattern as shown in Figure 51. There should be etch for the leads as well as etch for the thermal pad.
2. Place five holes in the area of the thermal pad. These holes should be 10 mils in diameter. Keep them small so that solder wicking through the holes is not a problem during reflow.
3. Additional vias may be placed anywhere along the thermal plane outside of the thermal pad area. This helps dissipate the heat generated by the THS306x family IC. These additional vias may be larger than the 10-mil diameter vias directly under the thermal pad. They can be larger because they are not in the thermal pad area to be soldered so that wicking is not a problem.
4. Connect all holes to the internal ground plane.
5. When connecting these holes to the ground plane, **do not** use the typical web or spoke via connection methodology. Web connections have a high thermal resistance connection that is useful for slowing the heat transfer during soldering operations. This makes the soldering of vias that have plane connections easier. In this application, however, low thermal resistance is desired for the most efficient heat transfer. Therefore, the holes under the THS306x family PowerPAD package should make their connection to the internal ground plane with a complete connection around the entire circumference of the plated-through hole.
6. The top-side solder mask should leave the terminals of the package and the thermal pad area with its five holes exposed. The bottom-side solder mask should cover the five holes of the thermal pad area. This prevents solder from being pulled away from the thermal pad area during the reflow process.
7. Apply solder paste to the exposed thermal pad area and all of the IC terminals.
8. With these preparatory steps in place, the IC is simply placed in position and run through the solder reflow operation as any standard surface-mount component. This results in a part that is properly installed.

## POWER DISSIPATION AND THERMAL CONSIDERATIONS

To maintain maximum output capabilities, the THS360x does not incorporate automatic thermal shutoff protection. The designer must take care to ensure that the design does not violate the absolute maximum junction temperature of the device. Failure may result if the absolute maximum junction temperature of 150°C is exceeded. For best performance, design for a maximum junction temperature of 125°C. Between 125°C and 150°C, damage does not occur, but the performance of the amplifier begins to degrade.

The thermal characteristics of the device are dictated by the package and the PC board. Maximum power dissipation for a given package can be calculated using the following formula.

$$P_{Dmax} = \frac{T_{max} - T_A}{\theta_{JA}}$$

where

$P_{Dmax}$  is the maximum power dissipation in the amplifier (W).

$T_{max}$  is the absolute maximum junction temperature (°C).

$T_A$  is the ambient temperature (°C).

$\theta_{JA} = \theta_{JC} + \theta_{CA}$

$\theta_{JC}$  is the thermal coefficient from the silicon junctions to the case (°C/W).

$\theta_{CA}$  is the thermal coefficient from the case to ambient air (°C/W).

For systems where heat dissipation is more critical, the THS306x family of devices is offered in an 8-pin MSOP with PowerPAD and the THS3062 is available in the SOIC–8 PowerPAD package offering even better thermal performance. The thermal coefficient for the PowerPAD packages are substantially improved over the traditional SOIC. Maximum power dissipation levels are depicted in the graph for the available packages. The data for the PowerPAD packages assume a board layout that follows the PowerPAD layout guidelines referenced above and detailed in the PowerPAD application note number SLMA002. The following graph also illustrates the effect of not soldering the PowerPAD to a PCB. The thermal impedance increases substantially which may cause serious heat and performance issues. Be sure to always solder the PowerPAD to the PCB for optimum performance.

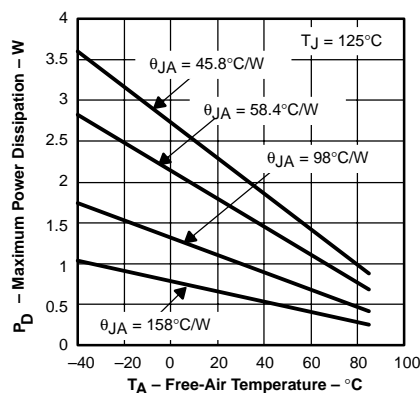

Results are With No Air Flow and PCB Size = 3"x3"  
 $\theta_{JA} = 45.8^\circ\text{C/W}$  for 8-Pin SOIC w/PowerPad (DDA)  
 $\theta_{JA} = 58.4^\circ\text{C/W}$  for 8-Pin MSOP w/PowerPad (DGN)  
 $\theta_{JA} = 98^\circ\text{C/W}$  for 8-Pin SOIC High Test PCB (D)  
 $\theta_{JA} = 158^\circ\text{C/W}$  for 8-Pin MSOP w/PowerPad w/o Solder

Figure 52. Maximum Power Dissipation vs Ambient Temperature

When determining whether or not the device satisfies the maximum power dissipation requirement, it is important to not only consider quiescent power dissipation, but also dynamic power dissipation. Often times, this is difficult to quantify because the signal pattern is inconsistent, but an estimate of the RMS power dissipation can provide visibility into a possible problem.

## DRIVING A CAPACITIVE LOAD

Driving capacitive loads with high-performance amplifiers is not a problem as long as certain precautions are taken. The first is to realize that the THS306x has been internally compensated to maximize its bandwidth and slew-rate performance. When the amplifier is compensated in this manner, capacitive loading directly on the output decreases the device's phase margin leading to high-frequency ringing or oscillations. Therefore, for capacitive loads of greater than 10 pF, it is recommended that a resistor be placed in series with the output of the amplifier, as shown in Figure 53. A minimum value of 10  $\Omega$  should work well for most applications. For example, in 75- $\Omega$  transmission systems, setting the series resistor value to 75  $\Omega$  both isolates any capacitance loading and provides the proper line impedance matching at the source end.

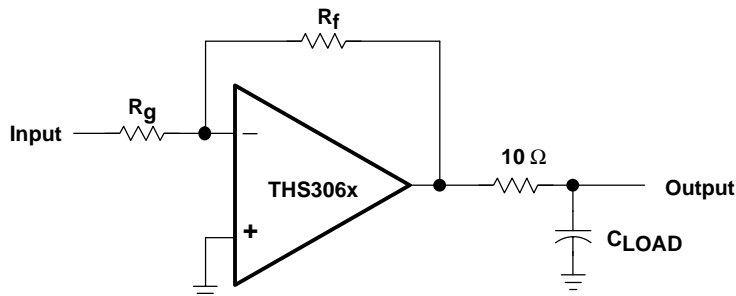

Figure 53. Driving a Capacitive Load

GENERAL CONFIGURATIONS

A common error for the first-time CFB user is creating a unity gain buffer amplifier by shorting the output directly to the inverting input. A CFB amplifier in this configuration oscillates and is *not* recommended. The THS306x, like all CFB amplifiers, *must* have a feedback resistor for stable operation. Additionally, placing capacitors directly from the output to the inverting input is not recommended. This is because, at high frequencies, a capacitor has a very low impedance. This results in an unstable amplifier and should not be considered when using a current-feedback amplifier. Because of this, integrators and simple low-pass filters, which are easily implemented on a VFB amplifier, have to be designed slightly differently. If filtering is required, simply place an RC-filter at the noninverting terminal of the operational-amplifier (see Figure 54).

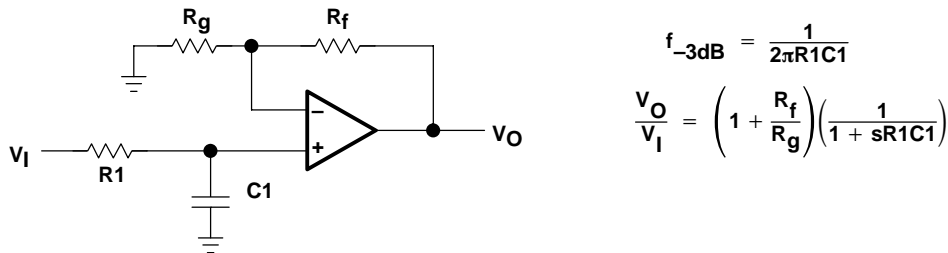

Figure 54. Single-Pole Low-Pass Filter

If a multiple-pole filter is required, the use of a Sallen-Key filter can work very well with CFB amplifiers. This is because the filtering elements are not in the negative feedback loop and stability is not compromised. Because of their high slew-rates and high bandwidths, CFB amplifiers can create very accurate signals and help minimize distortion. An example is shown in Figure 55.

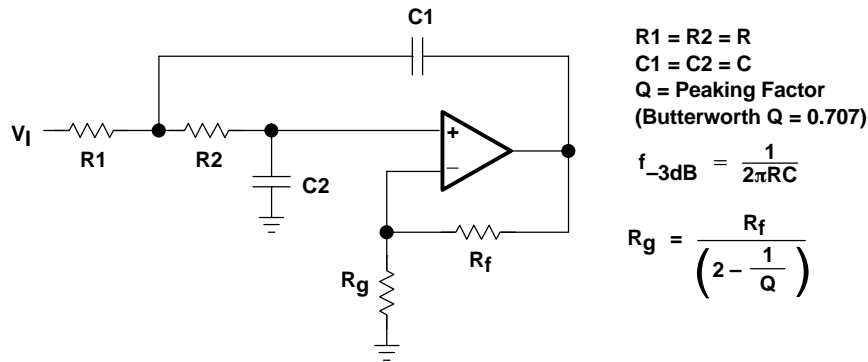

Figure 55. 2-Pole Low-Pass Sallen-Key Filter

There are two simple ways to create an integrator with a CFB amplifier. The first, shown in Figure 56, adds a resistor in series with the capacitor. This is acceptable because at high frequencies, the resistor is dominant and the feedback impedance never drops below the resistor value. The second, shown in Figure 57, uses positive feedback to create the integration. Caution is advised because oscillations can occur due to the positive feedback.

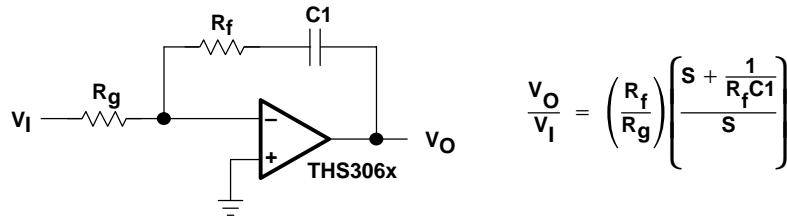

Figure 56. Inverting CFB Integrator

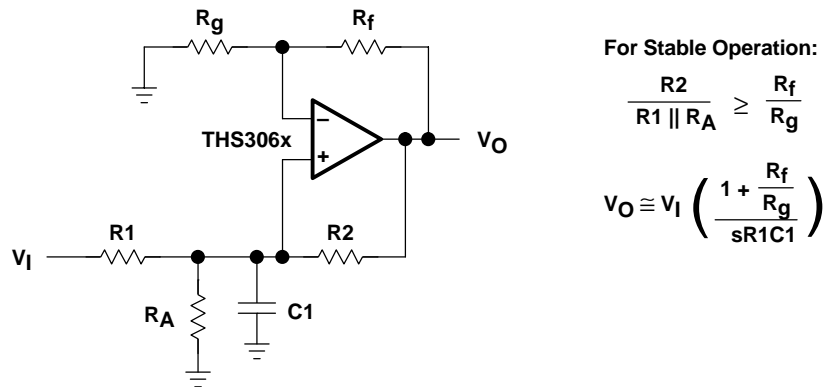

Figure 57. Noninverting CFB Integrator

The THS306x may also be employed as a very good video distribution amplifier. One characteristic of distribution amplifiers is the fact that the differential phase (DP) and the differential gain (DG) are compromised as the number of lines increases and the closed-loop gain increases. Be sure to use termination resistors throughout the distribution system to minimize reflections and capacitive loading.

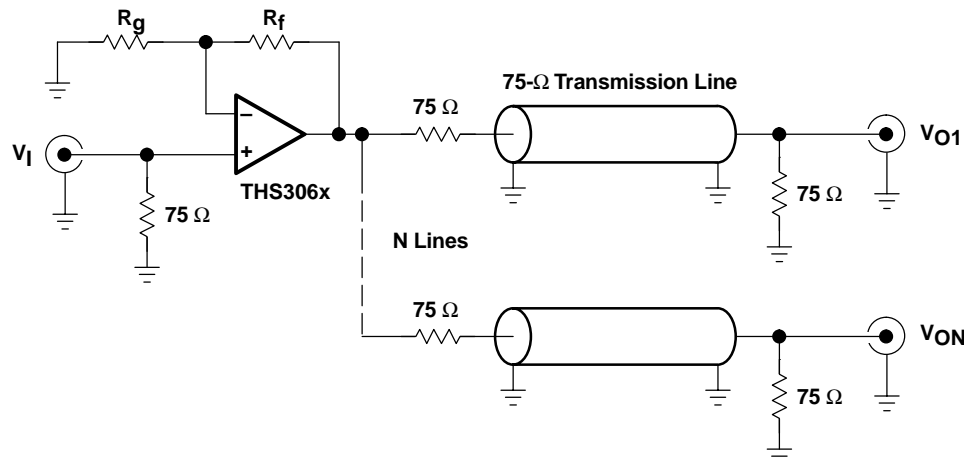

Figure 58. Video Distribution Amplifier Application

MECHANICAL INFORMATION

D (R-PDSO-G\*\*)

PLASTIC SMALL-OUTLINE PACKAGE

14 PIN SHOWN

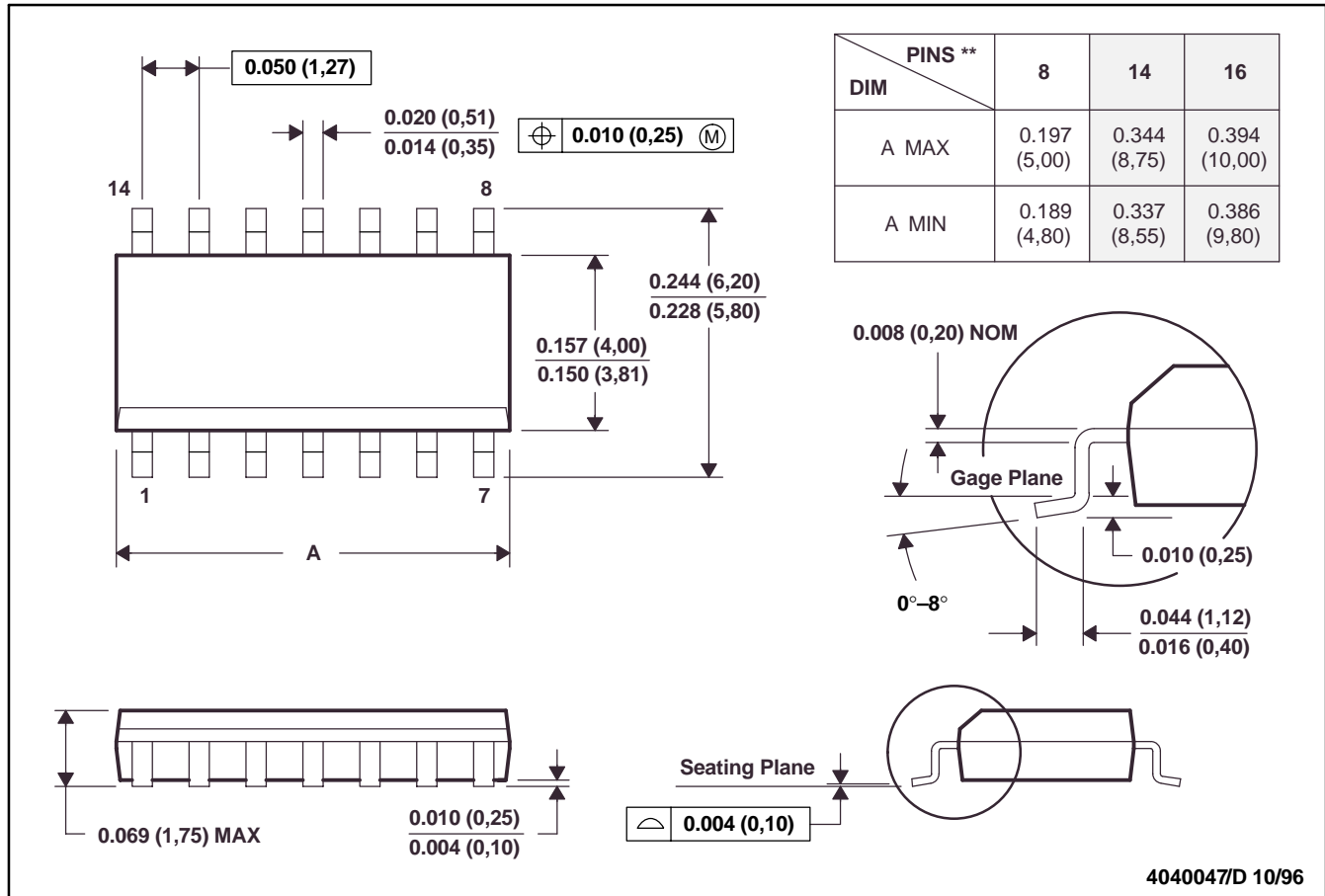

- NOTES: A. All linear dimensions are in inches (millimeters).  
 B. This drawing is subject to change without notice.  
 C. Body dimensions do not include mold flash or protrusion, not to exceed 0.006 (0,15).  
 D. Falls within JEDEC MS-012

MECHANICAL INFORMATION

DDA (S-PDSO-G8)

Power PAD™ PLASTIC SMALL-OUTLINE

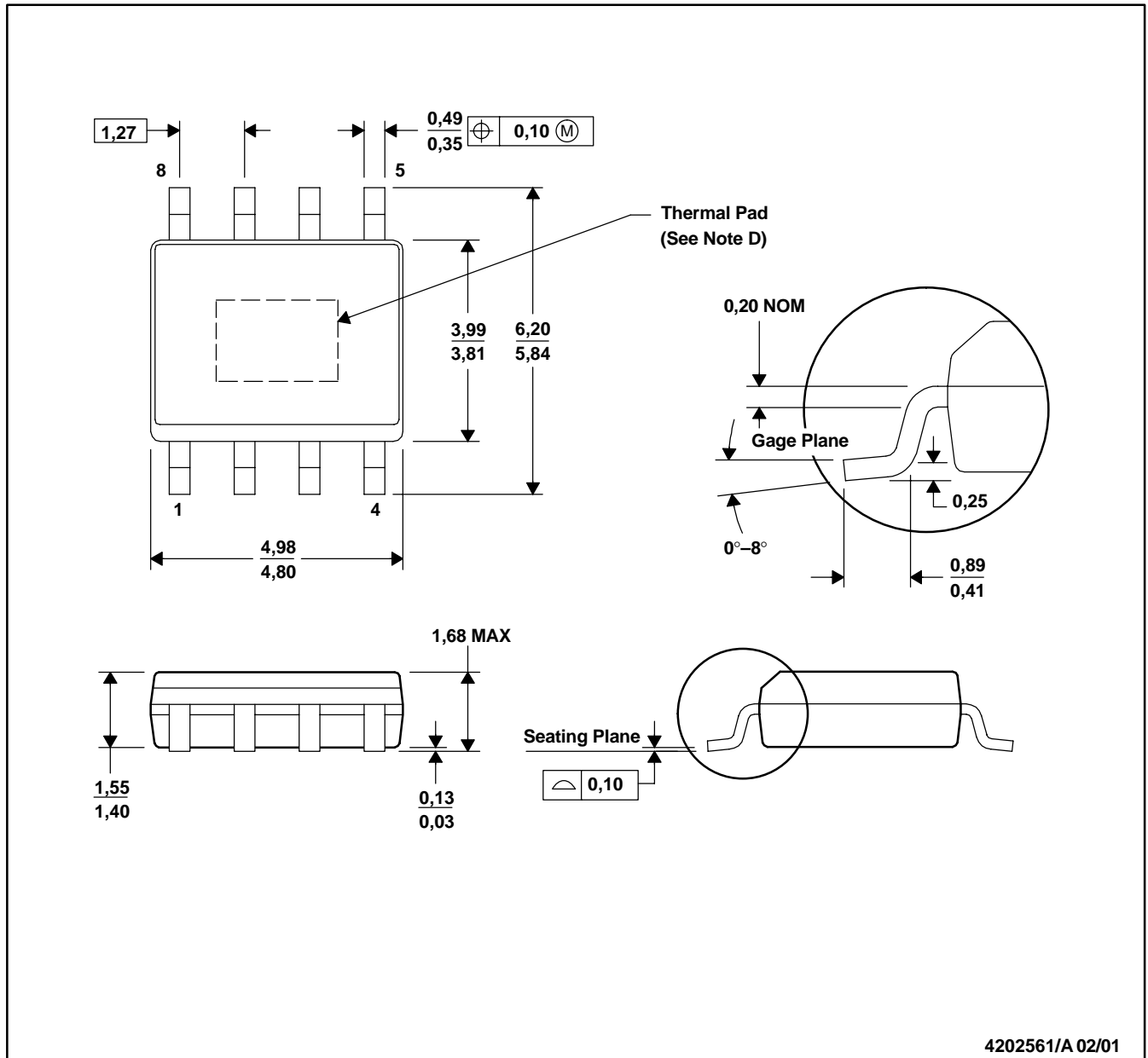

- NOTES:
- A. All linear dimensions are in millimeters.
  - B. This drawing is subject to change without notice.
  - C. Body dimensions do not include mold flash or protrusion not to exceed 0,15.
  - D. The package thermal performance may be enhanced by bonding the thermal pad to an external thermal plane. This pad is electrically and thermally connected to the backside of the die and possibly selected leads.





## IMPORTANT NOTICE

Texas Instruments Incorporated and its subsidiaries (TI) reserve the right to make corrections, modifications, enhancements, improvements, and other changes to its products and services at any time and to discontinue any product or service without notice. Customers should obtain the latest relevant information before placing orders and should verify that such information is current and complete. All products are sold subject to TI's terms and conditions of sale supplied at the time of order acknowledgment.

TI warrants performance of its hardware products to the specifications applicable at the time of sale in accordance with TI's standard warranty. Testing and other quality control techniques are used to the extent TI deems necessary to support this warranty. Except where mandated by government requirements, testing of all parameters of each product is not necessarily performed.

TI assumes no liability for applications assistance or customer product design. Customers are responsible for their products and applications using TI components. To minimize the risks associated with customer products and applications, customers should provide adequate design and operating safeguards.

TI does not warrant or represent that any license, either express or implied, is granted under any TI patent right, copyright, mask work right, or other TI intellectual property right relating to any combination, machine, or process in which TI products or services are used. Information published by TI regarding third-party products or services does not constitute a license from TI to use such products or services or a warranty or endorsement thereof. Use of such information may require a license from a third party under the patents or other intellectual property of the third party, or a license from TI under the patents or other intellectual property of TI.

Reproduction of information in TI data books or data sheets is permissible only if reproduction is without alteration and is accompanied by all associated warranties, conditions, limitations, and notices. Reproduction of this information with alteration is an unfair and deceptive business practice. TI is not responsible or liable for such altered documentation.

Resale of TI products or services with statements different from or beyond the parameters stated by TI for that product or service voids all express and any implied warranties for the associated TI product or service and is an unfair and deceptive business practice. TI is not responsible or liable for any such statements.

### Mailing Address:

Texas Instruments  
Post Office Box 655303  
Dallas, Texas 75265