

0.5mm Pitch

SERIES

# 6214

0.5mmピッチ ストレート SMT 片面接点 スライドロック  
0.5mmPitch Vertical SMT Single-sided contact Slide lock

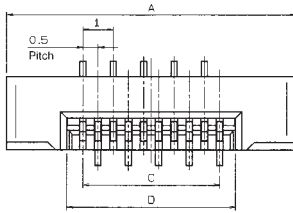

標準タイプ Standard Slider

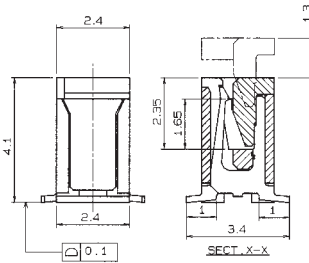
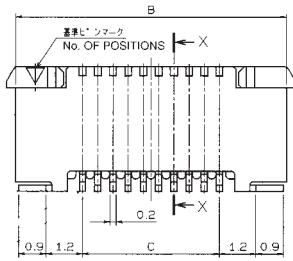

| 極数<br>NO. OF<br>POS. | A    | B    | C    | D    |
|----------------------|------|------|------|------|
| 6                    | 7.5  | 6.9  | 2.5  | 3.6  |
| 7                    | 8.0  | 7.4  | 3.0  | 4.1  |
| 8                    | 8.5  | 7.9  | 3.5  | 4.6  |
| 9                    | 9.0  | 8.4  | 4.0  | 5.1  |
| 10                   | 9.5  | 8.9  | 4.5  | 5.6  |
| 11                   | 10.0 | 9.4  | 5.0  | 6.1  |
| 12                   | 10.5 | 9.9  | 5.5  | 6.6  |
| 13                   | 11.0 | 10.4 | 6.0  | 7.1  |
| 14                   | 11.5 | 10.9 | 6.5  | 7.6  |
| 15                   | 12.0 | 11.4 | 7.0  | 8.1  |
| 16                   | 12.5 | 11.9 | 7.5  | 8.6  |
| 17                   | 13.0 | 12.4 | 8.0  | 9.1  |
| 18                   | 13.5 | 12.9 | 8.5  | 9.6  |
| 19                   | 14.0 | 13.4 | 9.0  | 10.1 |
| 20                   | 14.5 | 13.9 | 9.5  | 10.6 |
| 21                   | 15.0 | 14.4 | 10.0 | 11.1 |
| 22                   | 15.5 | 14.9 | 10.5 | 11.6 |
| 23                   | 16.0 | 15.4 | 11.0 | 12.1 |
| 24                   | 16.5 | 15.9 | 11.5 | 12.6 |
| 25                   | 17.0 | 16.4 | 12.0 | 13.1 |
| 26                   | 17.5 | 16.9 | 12.5 | 13.6 |
| 27                   | 18.0 | 17.4 | 13.0 | 14.1 |
| 28                   | 18.5 | 17.9 | 13.5 | 14.6 |
| 29                   | 19.0 | 18.4 | 14.0 | 15.1 |
| 30                   | 19.5 | 18.9 | 14.5 | 15.6 |

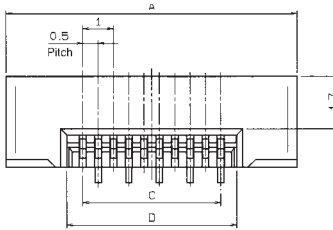

スライダー拡張タイプ Extended Slider

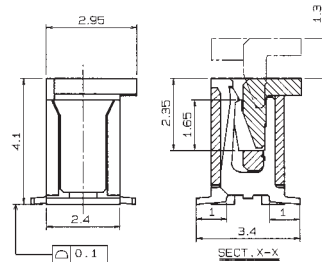
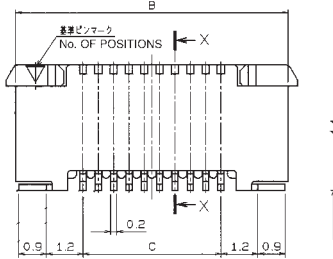

| 極数<br>NO. OF<br>POS. | A    | B    | C    | D    |
|----------------------|------|------|------|------|
| 6                    | 7.5  | 6.9  | 2.5  | 3.6  |
| 7                    | 8.0  | 7.4  | 3.0  | 4.1  |
| 8                    | 8.5  | 7.9  | 3.5  | 4.6  |
| 9                    | 9.0  | 8.4  | 4.0  | 5.1  |
| 10                   | 9.5  | 8.9  | 4.5  | 5.6  |
| 11                   | 10.0 | 9.4  | 5.0  | 6.1  |
| 12                   | 10.5 | 9.9  | 5.5  | 6.6  |
| 13                   | 11.0 | 10.4 | 6.0  | 7.1  |
| 14                   | 11.5 | 10.9 | 6.5  | 7.6  |
| 15                   | 12.0 | 11.4 | 7.0  | 8.1  |
| 16                   | 12.5 | 11.9 | 7.5  | 8.6  |
| 17                   | 13.0 | 12.4 | 8.0  | 9.1  |
| 18                   | 13.5 | 12.9 | 8.5  | 9.6  |
| 19                   | 14.0 | 13.4 | 9.0  | 10.1 |
| 20                   | 14.5 | 13.9 | 9.5  | 10.6 |
| 21                   | 15.0 | 14.4 | 10.0 | 11.1 |
| 22                   | 15.5 | 14.9 | 10.5 | 11.6 |
| 23                   | 16.0 | 15.4 | 11.0 | 12.1 |
| 24                   | 16.5 | 15.9 | 11.5 | 12.6 |
| 25                   | 17.0 | 16.4 | 12.0 | 13.1 |
| 26                   | 17.5 | 16.9 | 12.5 | 13.6 |
| 27                   | 18.0 | 17.4 | 13.0 | 14.1 |
| 28                   | 18.5 | 17.9 | 13.5 | 14.6 |
| 29                   | 19.0 | 18.4 | 14.0 | 15.1 |
| 30                   | 19.5 | 18.9 | 14.5 | 15.6 |

生産対応可能極数については、営業部にご確認  
願います。

Feel free to contact our sales depart-  
ment for available numbers of positions.

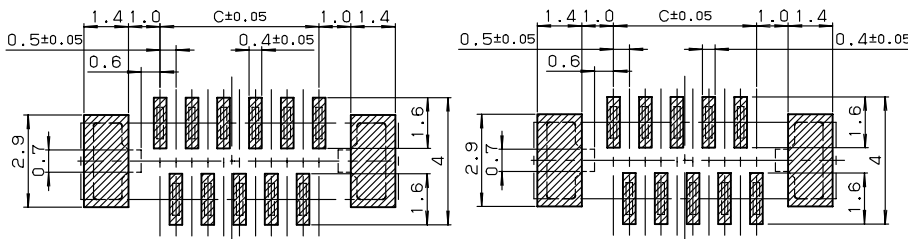

基板取付寸法 (奇数ピン)

MOUNTING LAYOUT (ODD PIN)

基板取付寸法 (偶数ピン)

MOUNTING LAYOUT (EVEN PIN)

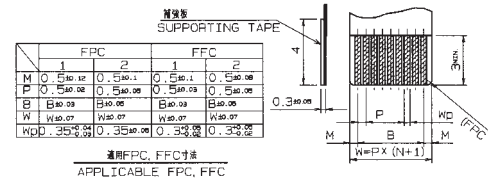

適用FPC, FFC寸法  
APPLICABLE FPC, FFC

注文コード ORDERING CODE

04 6214 0XX XXX XXX X

800+: スズ銅めっき Sn-Cu Plated (RoHS対応品 RoHS Compliant Product)

800: スズ鉛めっき Sn-Pb Plated

846+: 金めっき Au Plated (RoHS対応品 RoHS Compliant Product)

000: 標準タイプ Standard Slider

010: スライダー拡張タイプ Extended Slider

極数 NUMBER OF POSITIONS

0.5mm Pitch

SERIES

# 6214 エンボス梱包品 Tape and Reel Package

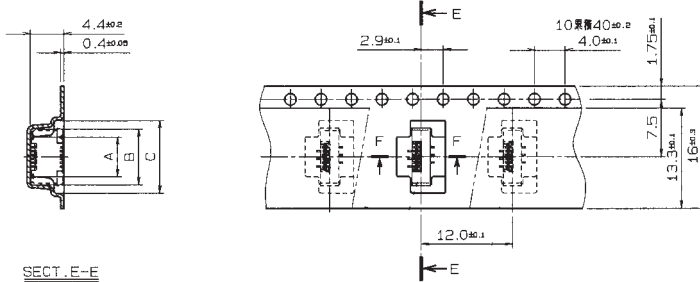

SECT. E-E

| 寸法表 DIMENSION     |                      |     |     |      |
|-------------------|----------------------|-----|-----|------|
| 極数<br>NO. OF POS. | 型番                   | A   | B   | C    |
| 6                 | 04 6214 006 XXX XXXX | 5.2 | 7.3 | 9.5  |
| 7                 | 04 6214 007 XXX XXXX | 5.7 | 7.8 | 10.0 |
| 8                 | 04 6214 008 XXX XXXX | 6.2 | 8.3 | 10.5 |

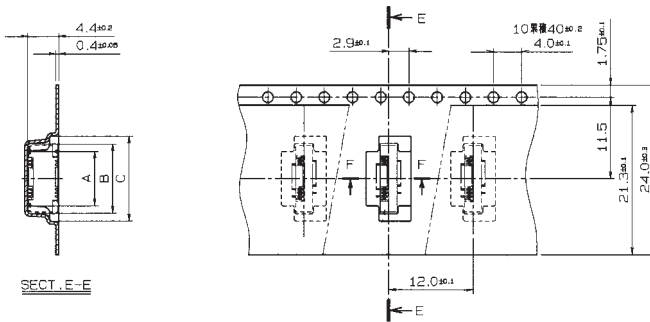

SECT. E-E

| 寸法表 DIMENSION     |                      |      |      |      |
|-------------------|----------------------|------|------|------|
| 極数<br>NO. OF POS. | 型番                   | A    | B    | C    |
| 9                 | 04 6214 009 XXX XXXX | 6.7  | 8.8  | 11.0 |
| 10                | ▲ 010 ▲              | 7.2  | 9.3  | 11.5 |
| 11                | 011                  | 7.7  | 9.8  | 12.0 |
| 12                | 012                  | 8.2  | 10.3 | 12.5 |
| 13                | 013                  | 8.7  | 10.8 | 13.0 |
| 14                | 014                  | 9.2  | 11.3 | 13.5 |
| 15                | 015                  | 9.7  | 11.8 | 14.0 |
| 16                | 016                  | 10.2 | 12.3 | 14.5 |
| 17                | 017                  | 10.7 | 12.8 | 15.0 |
| 18                | 018                  | 11.2 | 13.3 | 15.5 |
| 19                | 019                  | 11.7 | 13.8 | 16.0 |
| 20                | 020                  | 12.2 | 14.3 | 16.5 |
| 21                | 021                  | 12.7 | 14.8 | 17.0 |
| 22                | 022                  | 13.2 | 15.3 | 17.5 |
| 23                | ▼ 023 ▼              | 13.7 | 15.8 | 18.0 |
| 24                | 04 6214 024 XXX XXXX | 14.2 | 16.3 | 18.5 |

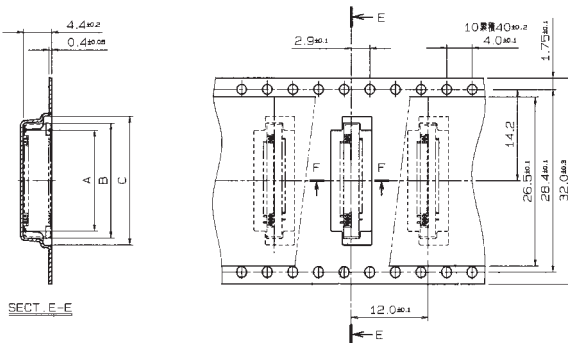

SECT. E-E

| 寸法表 DIMENSION     |                      |      |      |      |
|-------------------|----------------------|------|------|------|
| 極数<br>NO. OF POS. | 型番                   | A    | B    | C    |
| 25                | 04 6214 025 XXX XXXX | 14.7 | 16.8 | 19.0 |
| 26                | ▲ 026 ▲              | 15.2 | 17.3 | 19.5 |
| 27                | 027                  | 15.7 | 17.8 | 20.0 |
| 28                | 028                  | 16.2 | 18.3 | 20.5 |
| 29                | ▼ 029 ▼              | 16.7 | 18.8 | 21.0 |
| 30                | 04 6214 030 XXX XXXX | 17.2 | 19.3 | 21.5 |

生産対応可能極数については、営業部にご確認願います。  
Feel free to contact our sales department for available numbers of positions.

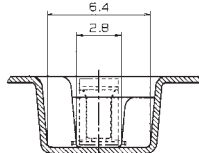

SECT. F-F

注文コード ORDERING CODE

04 6214 0XX XXX XXX X

- 800+ : スズ銅めっき Sn-Cu Plated (RoHS対応品 RoHS Compliant Product)
- 800 : スズ鉛めっき Sn-Pb Plated
- 846+ : 金めっき Au Plated (RoHS対応品 RoHS Compliant Product)

- 000 : 標準タイプ Standard Slider
- 010 : スライダー拡張タイプ Extended Slider

極数 NUMBER OF POSITIONS

梱包数量 1000個/リール  
PACKING QUANTITY : 1000/Reel