

745-080 → 240 -

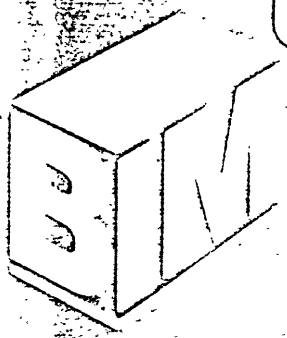



BOSS *BIMINDICATORS*



501

502

503

504

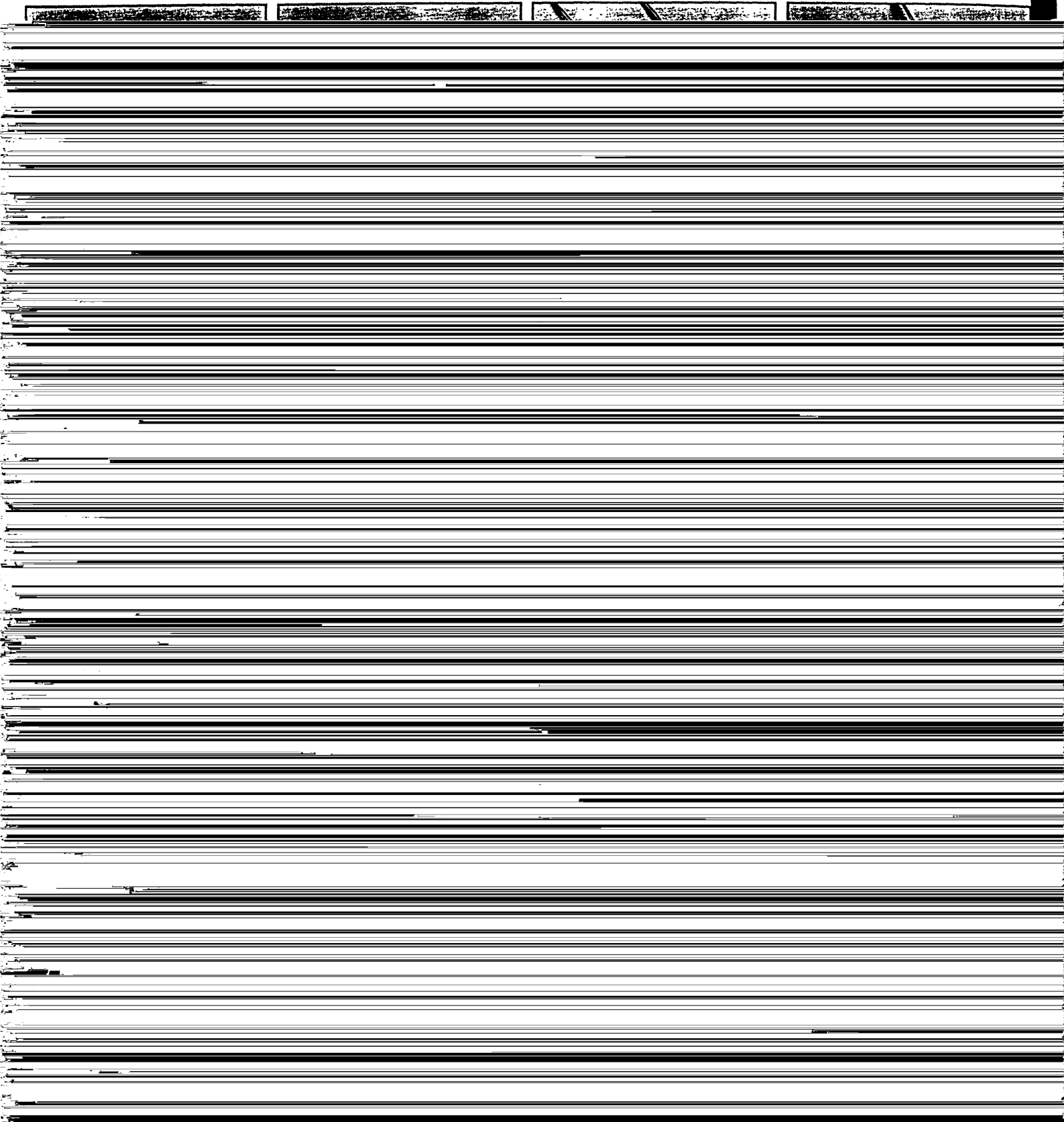

501

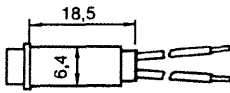

502

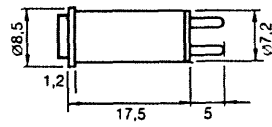

503

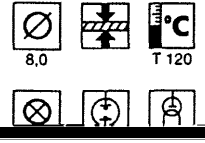
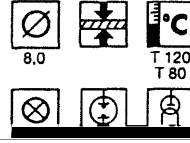
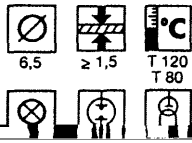
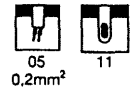
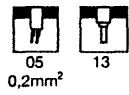
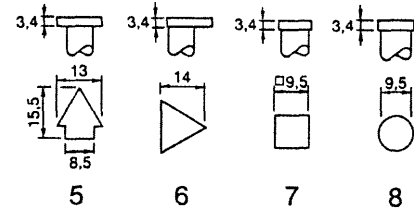
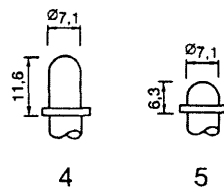
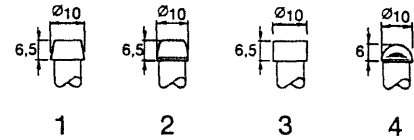
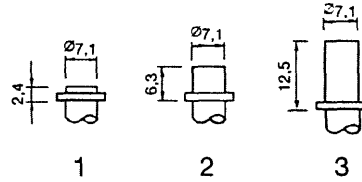
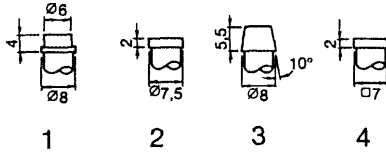
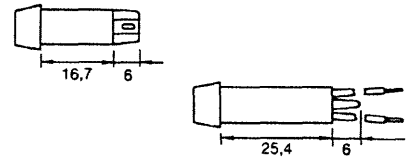

504

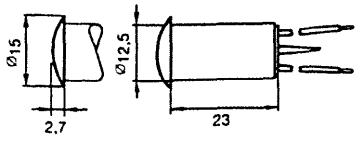

1

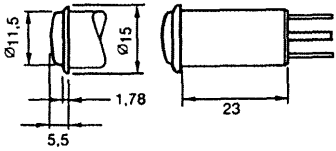

2

505

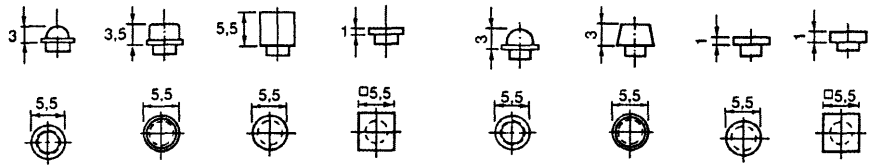
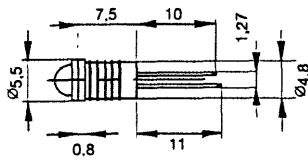

1

2

3

4

506

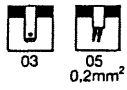
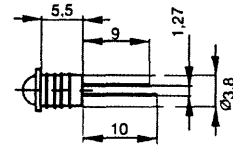

03

05

0,2mm²

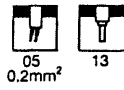

05

13

0,2mm²

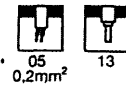

05

13

0,2mm²

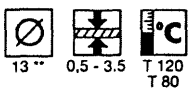

13 **

0,5 - 3,5

T 120

T 80



** 12,5 = ohne Chromring

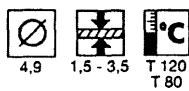

4,9

1,5 - 3,5

T 120

T 80

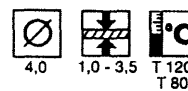

4,0

1,0 - 3,5

T 120

T 80

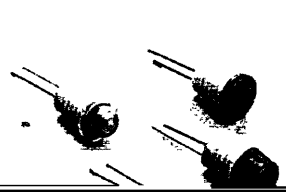
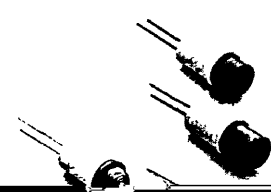
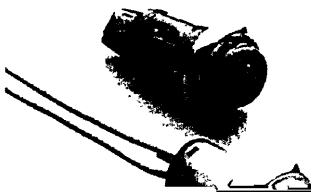

507

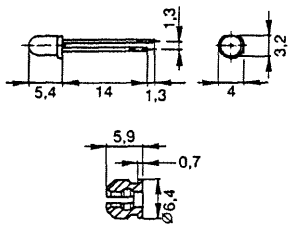

1

508

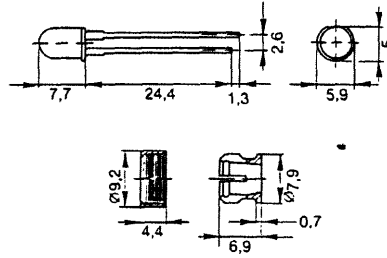

1

509

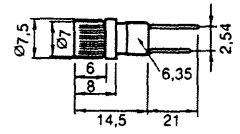

1

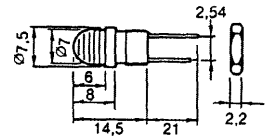

2

ap



13



13



13

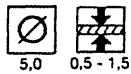

5,0

0,5 - 1,5



T 80

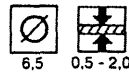

6,5

0,5 - 2,0

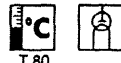

T 80

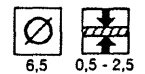

6,5

0,5 - 2,5



T 80

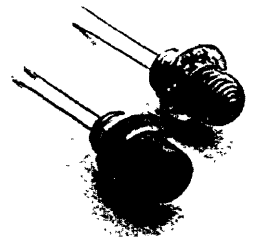
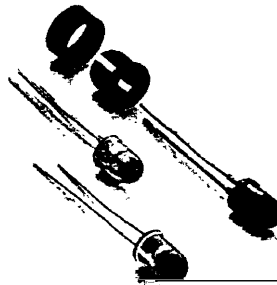
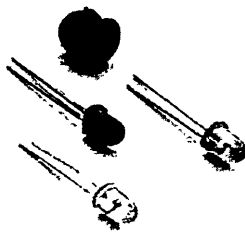

512

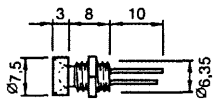

1

513

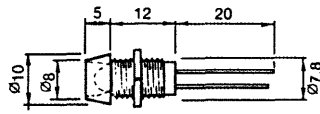

1

514

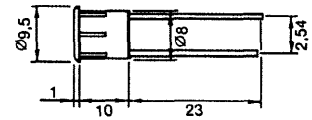

1

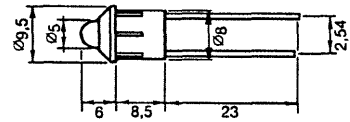

2



13



13



13

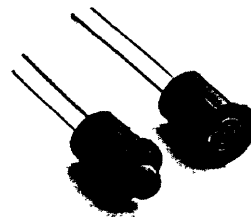
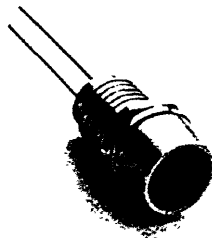
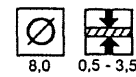
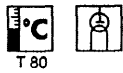
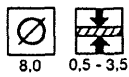
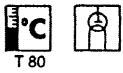
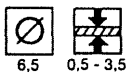

515

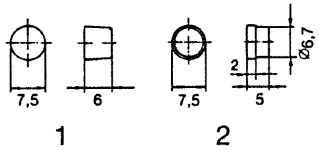
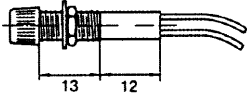

apj

516

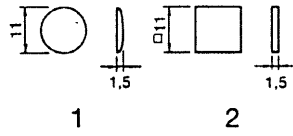
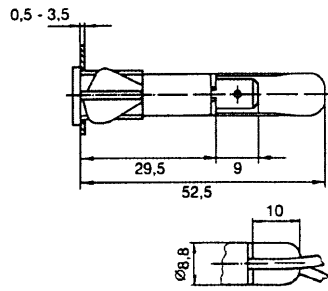

517

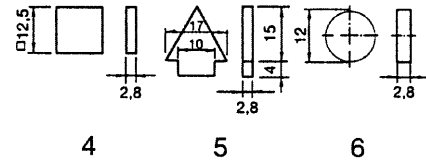
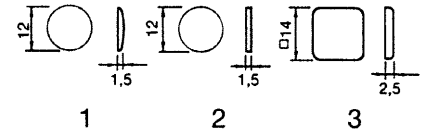
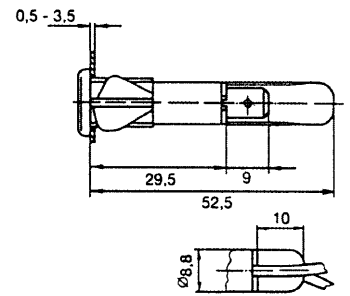

05

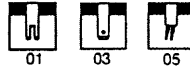

01 03 05

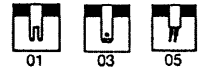

01 03 05



6,4 0,5 - 3,5 T 120

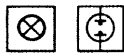

9,0 0,5 - 3,5 T 120

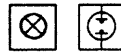

10 0,5 - 3,5 T 120

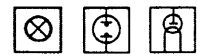

518

519

520

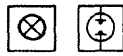
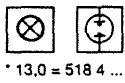
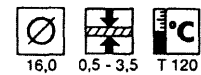
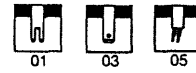
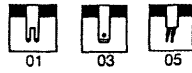
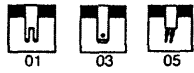
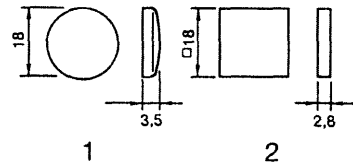
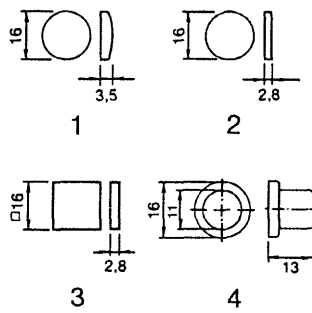
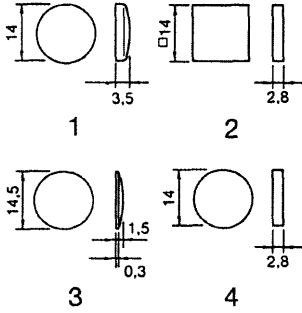
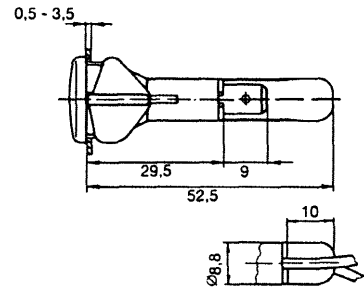
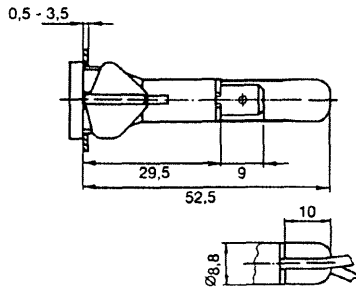
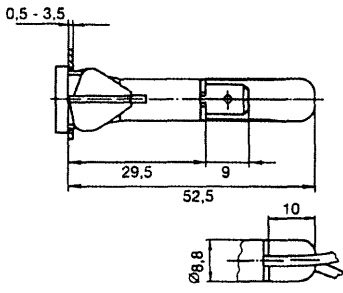

* 13,0 = 518 4 ...



521

570

580

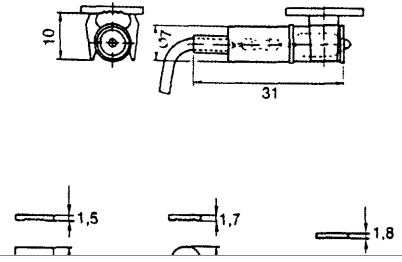
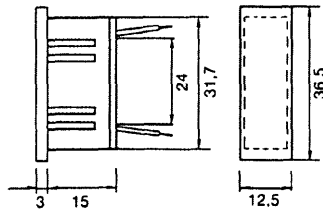
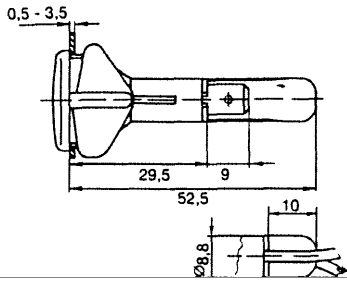

1 2 3

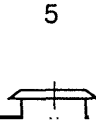
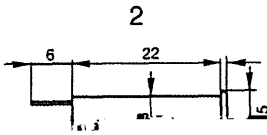
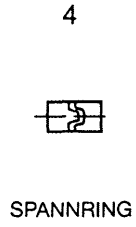
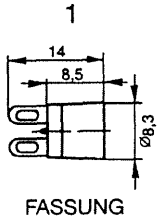

P + B bietet Konfektionierungen in 110 V,
220 V und 380 V- Ausführungen an.
Bitte fragen Sie an.

P + B offers assemblies in 110 V, 220 V
and 380 V.
Please inquire.

P + B offre des assemblees en 110 V

ATORS



BOSS *BIMINDICATORS*



519

520

521

570

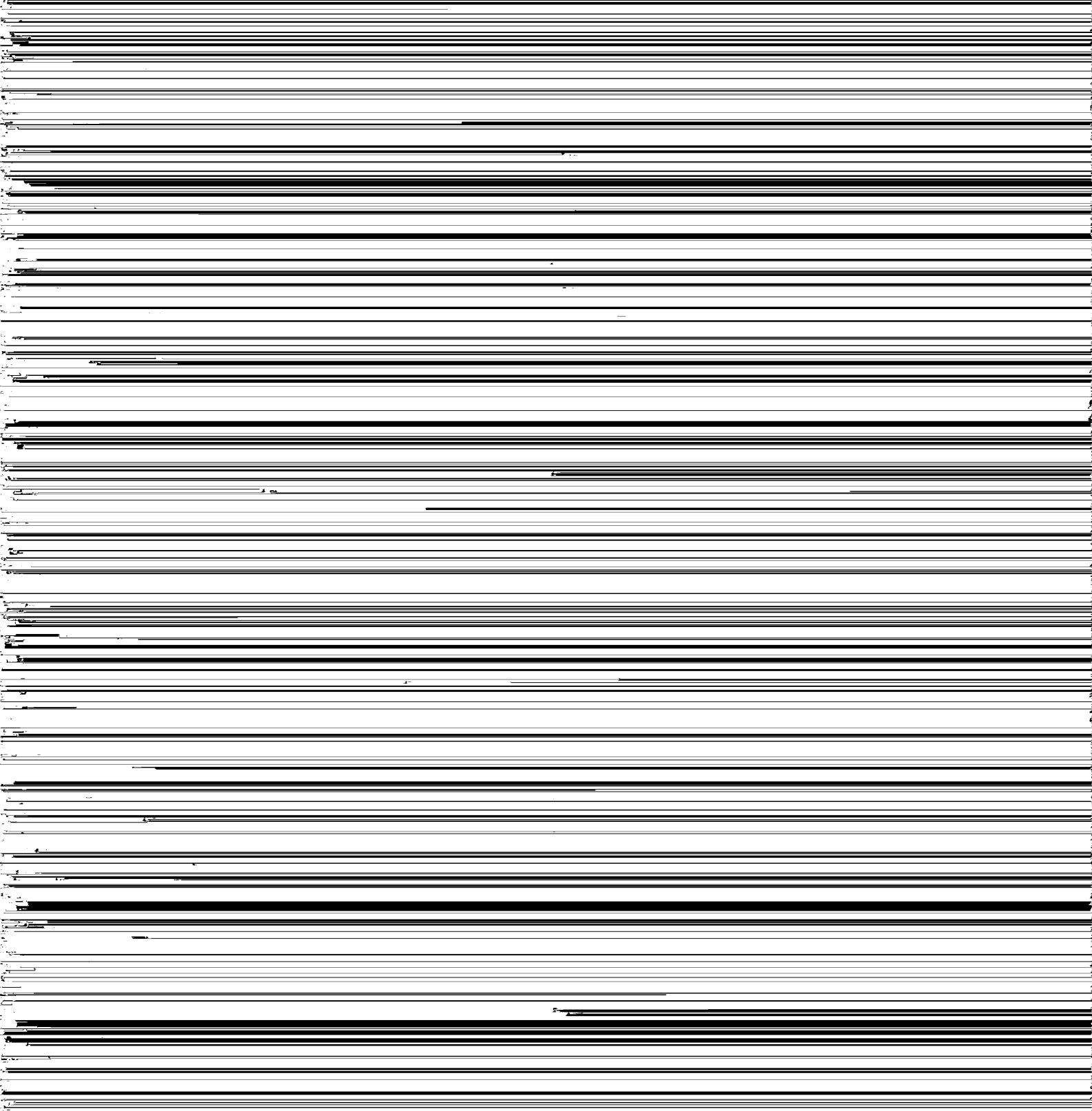
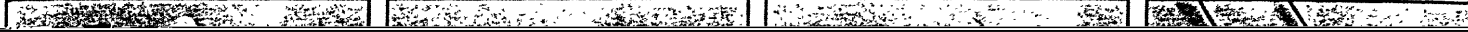

BOSS BIMINDICATORS



BOSS BIMINDICA

509

512

513

514

