

179-012 to 179-019  
~~179-021 to 179-028~~  
179-054

# Electronic Component Housings and PC Board Bases for Custom Circuits



**INNOVATION  
IN INTERFACE**

## Electronic Component Housings and PC Board Bases for Custom Circuits

With the trend to distribution and application of new technologies, more and more compact rail mountable housings with integrated connection systems are required for component PC board bases.

The comprehensive Phoenix housing range comprises three harmonized product groups: The **MODUFACE** and **UEG/UEGM** component housings and the **UM/UMK** PC board bases for custom circuits. The housings which are conceived in accordance with the modular principle accept printed circuit boards from a few square centimeters up to complex cards. All housings have in common the high stability, the solid workmanship and the rail mountable design.

The machine mounted components and ordered electronic groups are safely integrated in the component housings without additional screw fitting and provide full shock protection. The housings offer a wide range of connections from solid screw connections up to 2.5 mm<sup>2</sup> and tab connections through to multi-position electronic plug connectors.

The use of standard component housings reduces development time and costs, even the smallest batches and individual equipment can be economically produced. For large series the housings can be finished in a choice of six other colors in addition to the standard green color.

### Range Review

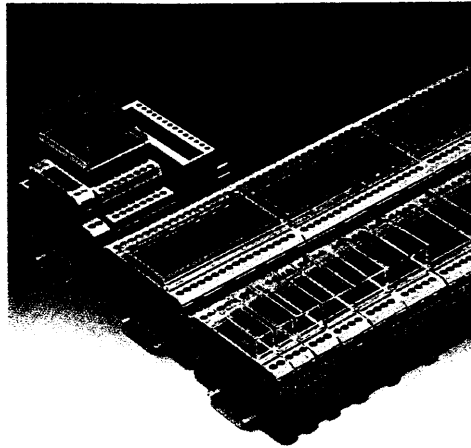

**Component Housing MODUFACE**

MODUFACE component housings are rail mountable small housings accepting electronic circuits and standard components. MODUFACE offers a selection of approx. 20 housing variations, which are available with a number of positions and grids from 10 mm to 150 mm. The empty housings are offered with screw, tab or COMBICON connections to meet practical requirements.

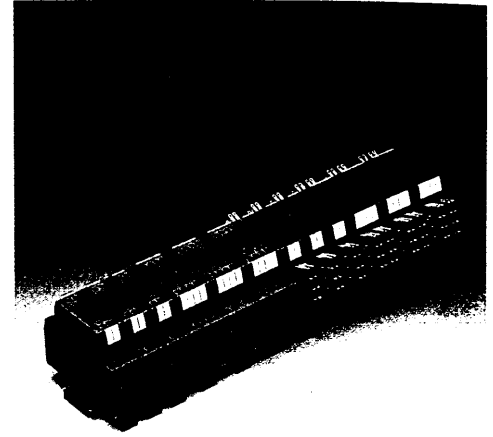

**Component Housings UEG**

The electronic component housing UEG is particularly suitable to accept made to measure adaption or conversion functions. It is available in 20 and 30 mm construction widths with individual custom fitted double level screw or tab connections. Using the universal foot these empty housings snap on to commercially available DIN EN mounting rails.

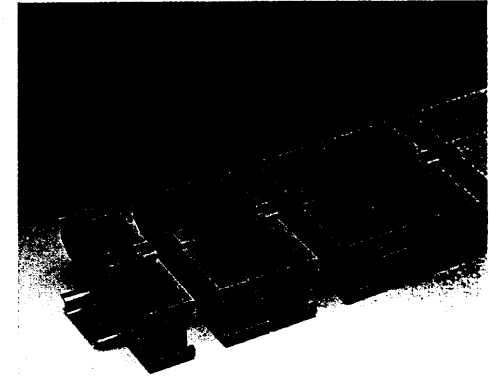
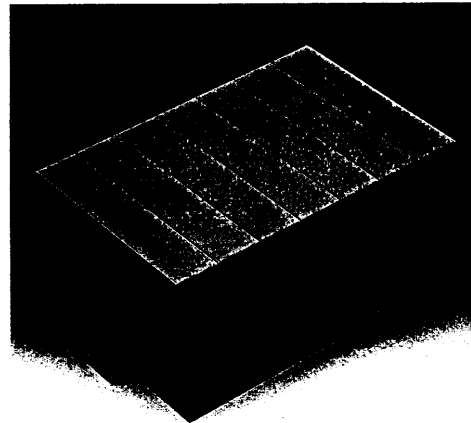
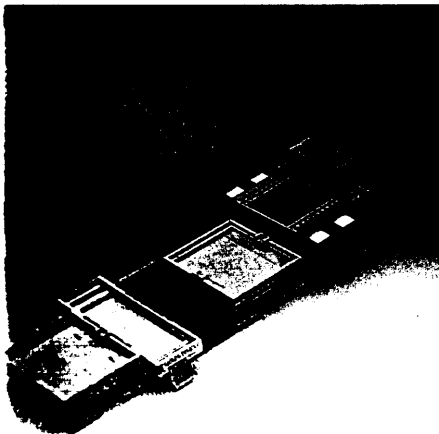

**Component Housing UEG-EU**

Using this housing for European format cards, even complex electronics are made rail mountable. The empty housing can be matched to all requirements by simply engaging the individual elements. Available as connection system are high position plug connectors as well as the comprehensive range of printed circuit terminal blocks (see catalog page 290).

**PC Board Bases for Custom Circuits UMK**

The universal module UMK permits professional rail mounting of electronics. The PC board bases for custom circuits are comprised of individual elements which can be optionally extended in the mounting rail longitudinal direction in accordance with the printed circuit board size. With its universal foot it can be engaged on commercially available DIN EN mounting rails.

The following review shows the various housing ranges.

Contents	Page
MODUFACE review	4-7
MODUFACE component housing	8-17
MODUFACE PCB layout	18-19
UEG component housing	20-21
UEGM component housing	22-23
UEGM-MSTB component housing	24
UEG-EU component housing	25
PCB layouts UEG, UEGM, UEGM-MSTB, UEG-EU	26-27
PC board bases for custom circuits UMK	28-29
Mounting plates UM	30-31
PC board bases for custom circuits MP	32

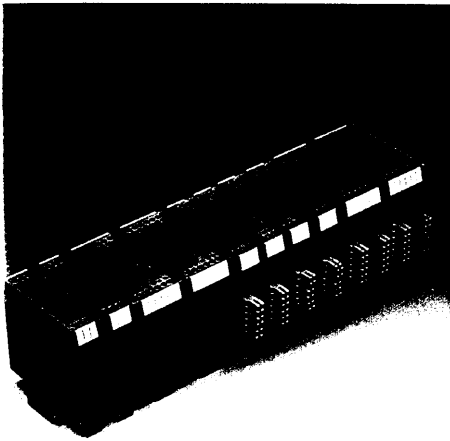

### Component Housings UEGM

The electronic component housing UEGM offers the practical possibility of fitting individual interface functions. Due to the various construction widths (22.5, 25 and 40 mm) with optional screw and/or tab connections it easily meets individual requirements and needs. The housings snap on to commercially available DIN EN mounting rails.

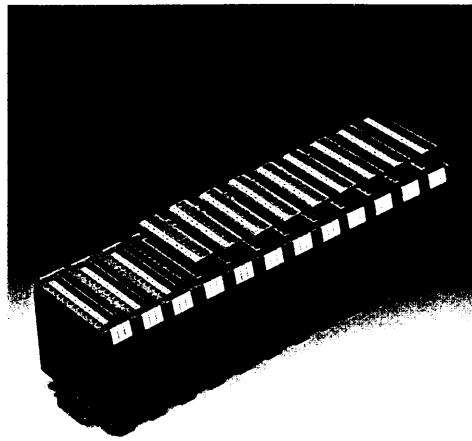

### Component Housing UEGM-MSTB

The special feature of these 25 mm wide electronic component housings UEGM-MSTB is the connection of the external conductors through plug-in COMBICON pin strips. All standard COMBICON plug variations from 2 to 12 positions can mate the COMBICON pin strips. The individual connection points can be provided with light diodes. The empty housings possess a universal foot and snap on to commercially available DIN EN mounting rails.

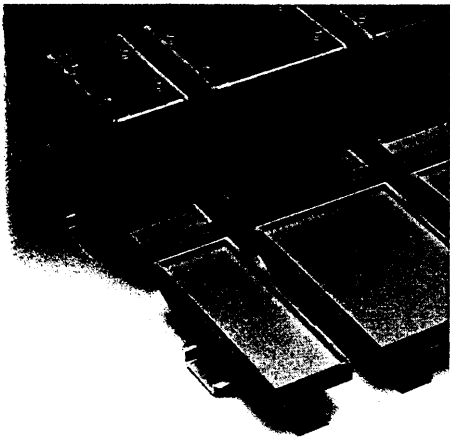

### PC Board Bases for Custom Circuits UM

The PC board bases for custom circuits UM offer the possibility of economically and quickly expanding rail mounted electronic circuits. The printed circuit board size can be optionally expanded in the mounting rail longitudinal direction by simply fitting the UM base elements in rows. The modules are available both with and without end covers. Due to their universal foot, these modules snap on to commercially available DIN EN mounting rails.

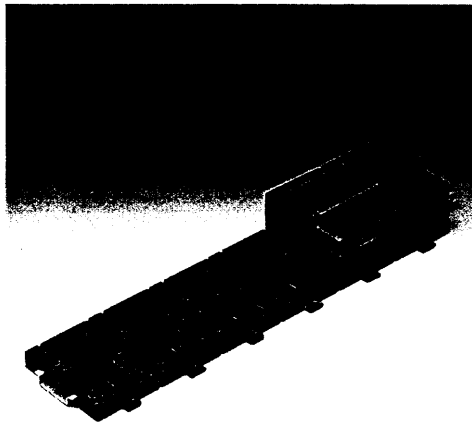

### Mounting Plates MP

The mounting plates for rail fitting have been specially designed to accept size 0 switching equipment.

# ODUFACE

General

MODUFACE is the name for a complete component housing range for the economical arrangement of industrial electronics according to switch cabinet referenced requirements. In the housing small interface circuits can be fitted as well as complete control units.

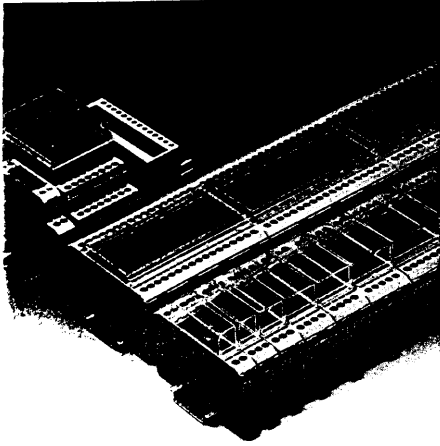

The component holder range can be divided into three delivery groups:

The first delivery form: individual parts are supplied without printed circuit boards for complete custom fitting

The second delivery form: the prefabricated modules offer a standard printed circuit board with solder points for custom soldering of construction elements. The third delivery form: here various housing variations can be individually combined.

Common features for all MODUFACE products:

Uniform and well designed housing system

Optimum and space saving accommodation of the electronics in finely stepped module variants, which can be selected in grids from 10 to 150 mm

Practical and easily wired conductor connection through solid screw terminals up to 2.5 mm<sup>2</sup> very fine strand or optional 6.3/2.8x0.8 mm tab connections or COMBICON or electronic plug connectors.

Easy snap fitting on the symmetrical mounting rails in accordance with DIN EN 50022

Shock and soil protected accommodation of electronic components

Selection between three cover sizes in transparent or non-transparent design.

## Design Principle

The blown-up view indicates the principle of the MODUFACE construction: the component fitted printed circuit board is inserted in the housing upper section and subsequently reliably engages with the housing base (no screws!).

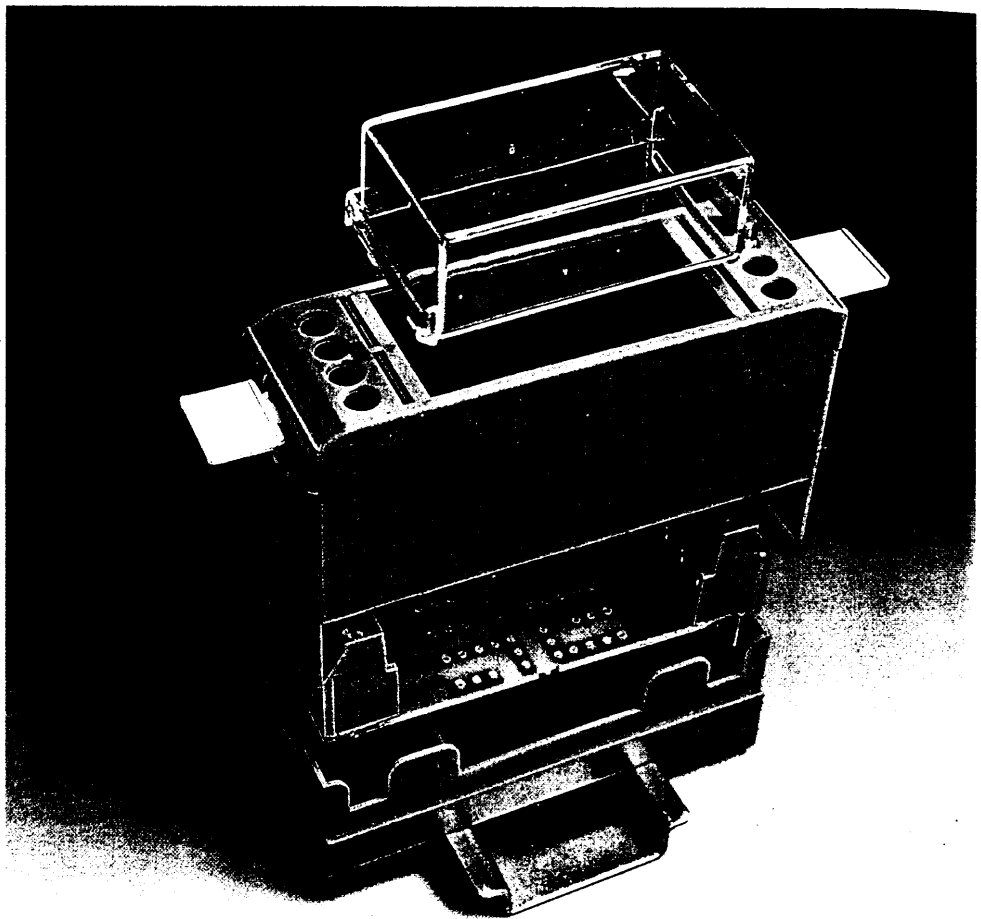

## Electronic Component Accommodation

The fine type stages permit optimum adaption of the housings to the required printed circuit board surface for the electronic components and to the required connection positions and: the printed circuit board geometry is rectangular. The layout of each printed circuit board with its dimensions, the connection points and the component side is represented on pages 18-19 in a scale of 1:1. The special feature: all electronic components and printed circuit terminal blocks can be fitted in accordance with production requirements and machine soldered in one operating cycle!

To create construction modules as narrow as possible with comprehensive electronic components, one or several additional

PCB's can be mounted perpendicularly on the main PCB, via suitable connection elements. The layout of this additional printed circuit board including dimensions, the points for the connection element and the component side is represented on page 19 in a 1:1 scale.

## Three Cover Heights

The transparent or non-transparent green hoods available protect the internal electronics from shock and the ingress of dirt. The cover simply snaps on; it can be removed again at any time. The front permits the installation of display or actuation elements and a surface for a circuit print label. Economical quantities justify the production of covers upon request with front break-outs or prints.

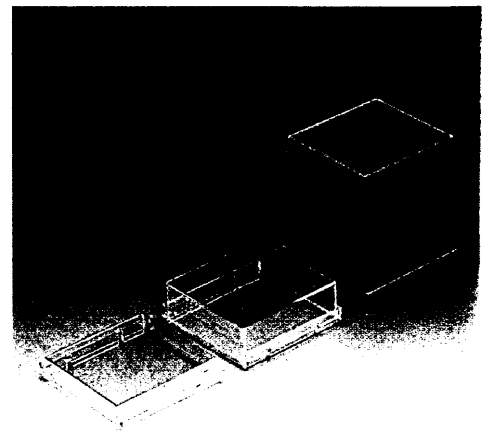
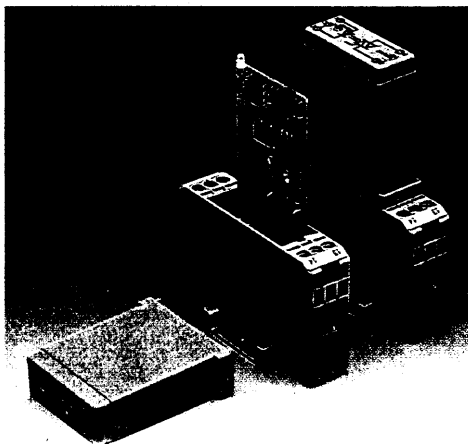

Special keying forms ensure that the covers can only be fitted in accordance with the circuit, i. e. as per the front print.

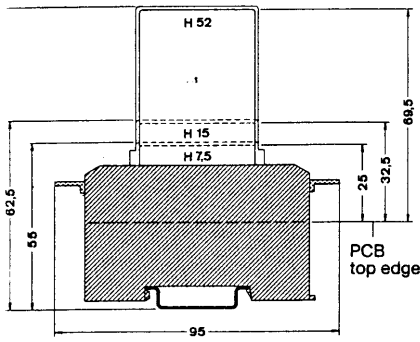

A selection can be made between three cover heights, permitting an optimum height matching to the electronics space requirement. The standard 7.5 and 15 mm high covers are transparent; upon request economical quantities allow the covers to be offered as non-transparent green. The 52 mm high cover is only available as non-transparent green. The tall covers are provided with guide grooves to accept the vertically positioned additional printed circuit boards.

**Conductor Connections**

Available designs are: solid 2.5 mm<sup>2</sup> screw connections in the form of printed circuit terminal blocks MKDS 3 in 5 mm grid dimensions on both sides (see catalog page 290). Some MODUFACE housings are alternatively available with screw terminal blocks with a 7.5 mm grid dimension; more details upon request.

Upon request, tab connections 6.3/2.8x0.8 mm; the 2, 3, and 4 position printed circuit strips with plastic ribs between the tabs can be fitted in rows in accordance with the grid spacing; to this effect the housing upper sections are supplied in a modified design on one or both sides with connection openings at the top.

Upon request with plug-in COMBICON connections when ordering economical batch sizes.

The connection components are always linked with the electronic components on the printed circuit board and are machine ordered. The upper section of the MODUFACE housing ensures an aesthetically elegant integration of the connection elements.

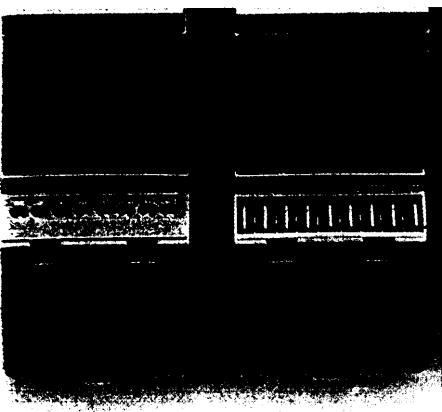

**Marking**

The marking of the connection terminal blocks is made on the marking slope by standard or individually printed marking strips SKS 5 or SKS 7.5 (see catalog page 290).

Economical quantities justify direct printing; more details upon request.

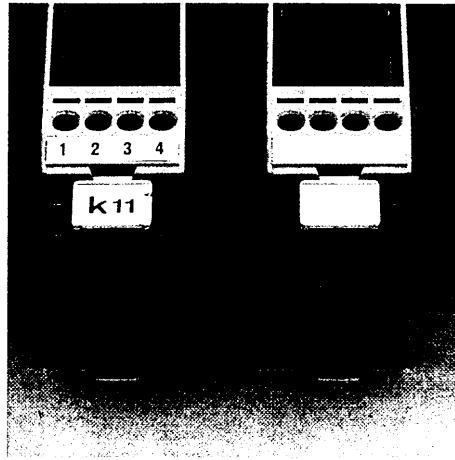

For module marking equipment marker labels EMG-GKS and EMG-SGKS are available, which can be inserted on both sides of the housing and individually marked.

**Assembly**

All MODUFACE modules are aligned in rows by simply engaging on the symmetrical mounting rail in accordance with DIN EN 50 022. Dismantling is made by pulling back the orange engagement latch.

To engage modules up to 30 mm width on the asymmetrical mounting rail in accordance with DIN EN 50 035 the adaptor EM-AD/NS 32 can be used.

Modules with a 12.5 and 25 mm width can also be individually mounted without a rail using a special plastic base.

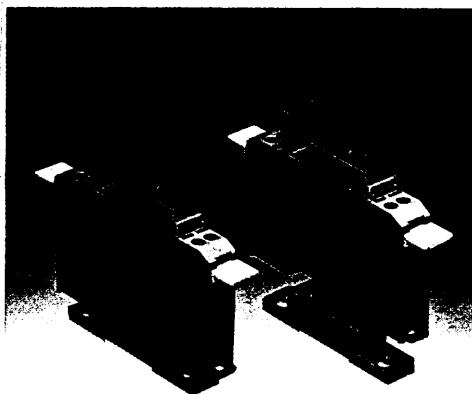

**Materials**

Housing components and transparent cover are made of difficult to ignite thermoplastics, suitable and internationally listed for permanent temperatures up to 100°C.

The housing protection type corresponds to IP 40; IP 20 for connection terminals.

mm to inch	
25	= (.984)
32.5	= (1.279)
55	= (2.165)
62.5	= (2.461)
69.5	= (2.736)
95	= (3.740)





# Electronic Modules EMG Custom Circuits

## EMG 10 10 mm wide, 4 position

## EMG 12 12.5 mm wide, 4 position

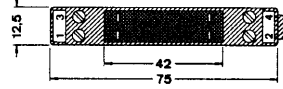
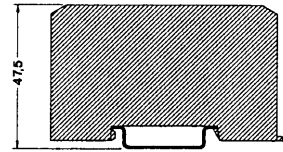
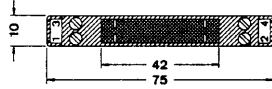
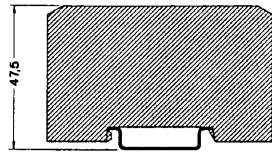
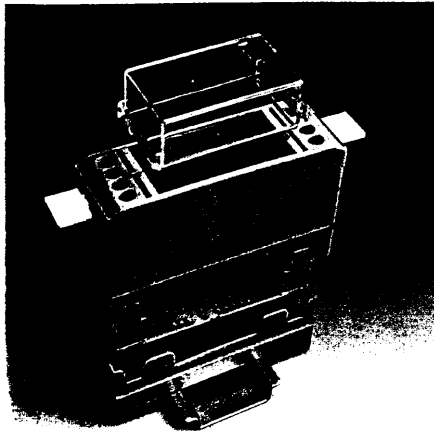

Custom circuit modules are designed with solder support points allowing free component installation. The empty modules (without printed circuit board and connector terminal blocks) offer the possibility of accommodating electronic circuits in dust shock proof, low cost housings.

	[mm <sup>2</sup> ]	AWG
Connection data, fine strand	2.5	12
Connection data, solid strand	4	12

	[mm <sup>2</sup> ]	AWG	I [A]
Connection data, fine strand	2.5	12	20/5
Connection data, solid strand	4	12	
Tab connection 6.3/2.8x0.8 mm, DIN 46249:			

Description	Type	Order No.	Pcs. Pkt.	Type	Order No.	Pcs. Pkt.
Empty module, for PCB insertion, without screw connection terminal block and cover	Grid 5 Grid 7.5	<b>EMG 10-LG</b>	<b>29 47 74 7</b>	<b>EMG 12-LG</b>	<b>29 48 28 3</b>	10
Empty module, for PCB insertion, without tab connection strip and cover				<b>EMG 12-LG-FSR</b> <b>EMG 12-LG-FSL</b> <b>EMG 12-LG-FS/FS</b>	<b>29 44 06 7</b> <b>29 44 07 0</b> <b>29 44 08 3</b>	10 10 10
Empty circuit module, consisting of housing, connection terminal blocks MKDS 3 and PCB with points soldering in electronic components		<b>EMG 10-B2</b>	<b>29 47 75 0</b>	<b>EMG 12-B2</b>	<b>29 48 30 6</b>	10
Cover, to protect components from contact and contamination. Available in green or clear. Dimensional drawing see page 9	clear clear green	<b>EMG 10-H 7.5 mm clear</b> <b>EMG 10-H 15 mm clear</b> <b>EMG 10-H 52 mm green</b>	<b>29 47 76 3</b> <b>29 47 77 6</b> <b>29 47 78 9</b>	<b>EMG 12-H 7.5 mm clear</b> <b>EMG 12-H 15 mm clear</b> <b>EMG 12-H 52 mm green</b>	<b>29 47 11 6</b> <b>29 48 29 6</b> <b>29 47 12 9</b>	10 10 10
Printed circuit board, for populating electronic components (see page 18)		<b>P 1-EMG 10</b>	<b>29 47 79 2</b>	<b>P1-EMG 12</b>	<b>29 47 18 7</b>	5
Empty circuit terminal blocks, grid 5, soldering into the PCB (see catalog page 290)	2 position 3 position 4 position	<b>MKDS 3/2-EMG 10</b>	<b>17 12 34 2</b>	<b>MKDS 3/2</b>	<b>17 11 02 6</b>	50
Empty circuit terminal blocks, grid 7.5, soldering into the PCB (see catalog page 293)	2 position					
Connection strip, with tab connection for soldering into the PCB	2 position			<b>FLIS 2- (2-2.8-0.8) V</b>	<b>17 60 13 2</b>	50

### Component marking plate

narrow normal



Mounting rail, to snap modules → mounting rails, 1.27 mm (.445) wide

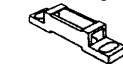

Mounting rail for direct fitting 1.27 mm (.492) wide

Power loss dependent upon the cover at 20° C

EMG 10 fitted with zero spacing

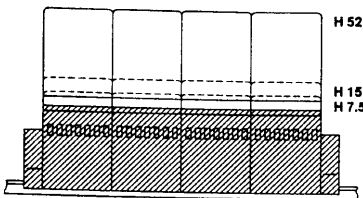

EMG 10 fitted with a spacing of ≥ 20 mm (.787)

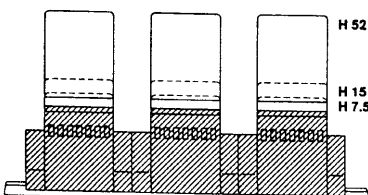

Power loss [W] at 20° C

	EMG 10	EMG 12	EMG 15	EMG 17	EMG 22
H 7.5 mm	0.9	1.2	1.2	1.3	1.4
H 15 mm	1.0	1.3	1.4	1.5	1.6
H 52 mm	1.5	2	2	2.1	2.3

Power loss [W] at 20° C

	EMG 10	EMG 12	EMG 15	EMG 17	EMG 22
H 7.5 mm	1.2	1.3	1.3	1.4	1.6
H 15 mm	1.4	1.5	1.5	1.6	1.8
H 52 mm	2.2	2.6	2.7	2.7	2.9

### Reduction factor dependent upon the ambient temperature

As the maximum permissible power loss is reduced with an increase in the ambient temperature, the listed reduction factor (K<sub>i</sub>) must be taken into account when calculating the permissible power loss.

K <sub>i</sub>	Ambient temperature [° C]				
	20	30	40	50	60
	1	0.8	0.64	0.51	0.41



**EMG 15**

15 mm wide,  
4 position with screw connection, grid 7.5  
6 position with screw connection, grid 5

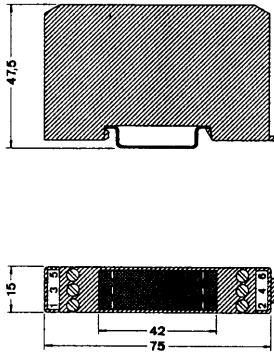

**EMG 17**

17.5 mm wide,  
4 position with screw connection, grid 7.5  
6 position with screw connection, grid 5

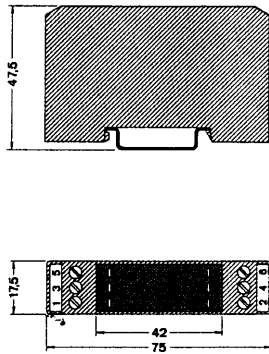

**EMG 22**

22.5 mm wide, 8 position

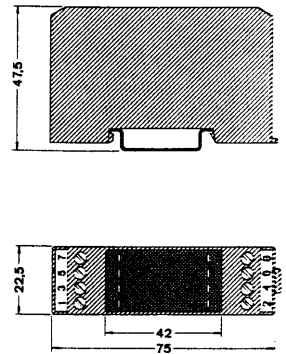

	[mm <sup>2</sup> ]	AWG
Connection data, fine strand	2.5	12
Connection data, solid strand	4	12

	[mm <sup>2</sup> ]	AWG
Connection data, fine strand	2.5	12
Connection data, solid strand	4	12

	[mm <sup>2</sup> ]	AWG
Connection data, fine strand	2.5	12
Connection data, solid strand	4	12

Type	Order No.	Pcs. Pkt.	Type	Order No.	Pcs. Pkt.	Type	Order No.	Pcs. Pkt.
MG 15-LG	29 47 80 2	10	EMG 17-LG	29 46 07 8	10	EMG 22-LG	29 46 13 3	10
MG 15-LG-7.5	29 44 09 6	10	EMG 17-LG-7.5	29 44 10 6	10			
MG 15-B3	29 47 81 5	10	EMG 17-B3	29 46 08 1	10	EMG 22-B4	29 46 14 6	10
MG 15-H 7.5 mm clear	29 47 82 8	10	EMG 17-H 7.5 mm clear	29 46 09 4	10	EMG 22-H 7.5 mm clear	29 46 15 9	10
MG 15-H 15 mm clear	29 47 83 1	10	EMG 17-H 15 mm clear	29 46 10 4	10	EMG 22-H 15 mm clear	29 46 16 2	10
MG 15-H 52 mm green	29 47 84 4	10	EMG 17-H 52 mm green	29 46 11 7	10	EMG 22-H 52 mm green	29 46 17 5	10
P1-EMG 15	29 47 85 7	5	P1-EMG 17	29 46 12 0	5	P1-EMG 22	29 46 18 8	5
MKDS 3/3-EMG 15	17 12 69 8	50	MKDS 3/2	17 11 02 6	50	MKDS 3/2	17 11 02 6	50
			MKDS 3/3	17 11 03 9	50	MKDS 3/3	17 11 03 9	50
			MKDS 3/4	17 11 04 2	50	MKDS 3/4	17 11 04 2	50
GMKDS 3/2-EMG 15	17 31 46 2	50	GMKDS 3/2	17 31 02 2	50			
MG-GKS	29 47 03 5	50	EMG-GKS	29 47 03 5	50	EMG-GKS	29 47 03 5	50
M-AD/NS 32	29 49 83 9	10	EM-AD/NS 32	29 49 83 9	10	EM-AD/NS 32	29 49 83 9	10

Power loss dependent upon the ambient temperature and cover height

$$P_{tu} = P_v t \times K_j$$

Explanations:  $P_v$  = power loss  
 $t$  = ambient temperature  
 $t = 20^\circ \text{C}$   
 $K_j$  = reduction factor

Example:  
 Power loss at  $40^\circ \text{C}$  in EMG 12, mounted without spacing, cover height H 15 mm

$$P_{40^\circ \text{C}} = P_v 20^\circ \text{C} \times K_j = 1.3 \text{ W} \times 0.64 = 0.83 \text{ W}$$

Dimensional drawing of electronic modules EMG

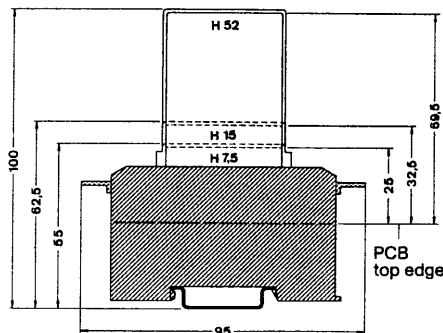

Design of the electronic modules EMG with tab connection

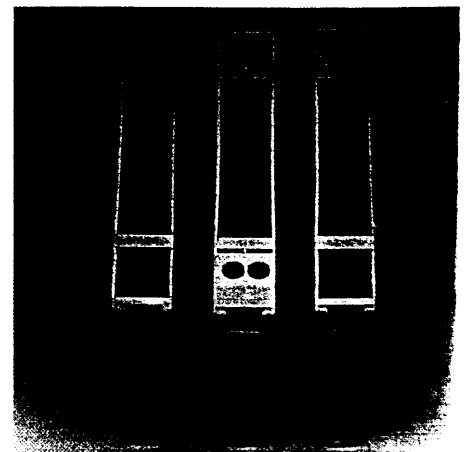

mm to inch	
7.5	= (.295)
10	= (.394)
15	= (.591)
2.5	= (.098)
5	= (.197)
7.5	= (.295)
10	= (.394)
15	= (.591)
2.5	= (.098)
5	= (.197)
7.5	= (.295)
10	= (.394)
15	= (.591)
2.5	= (.098)
5	= (.197)
7.5	= (.295)
10	= (.394)
15	= (.591)

...-FS/FS ...-FSR ...-FSL

**Electronic Modules EMG**  
**Custom Circuits**

**EMG 25**  
25 mm wide, 8 position

**EMG 30**  
30 mm wide, 10 position

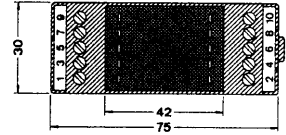
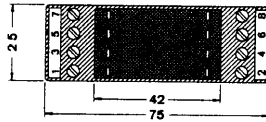
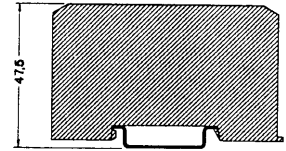
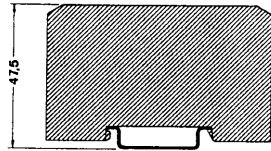

	[mm <sup>2</sup> ]	AWG
Connection data, fine strand	2.5	12
Connection data, solid strand	4	12

	[mm <sup>2</sup> ]	AWG
Connection data, fine strand	2.5	12
Connection data, solid strand	4	12

Description

**EMG 25-LG** module, for PCB insertion  
without screw connection  
terminal block and cover

**EMG 25-B4** custom circuit module, consisting of housing,  
connection terminal block MKDS 3 and PCB with points  
for soldering in electronic components

**EMG 25-H** cover, to protect components from contact and  
contamination. Available in green or clear.  
Dimensional drawing see page 11

**P1-EMG 25** printed circuit board,  
for mounting electronic components  
(see page 18)

**MKDS 3/2, 3/3, 3/4** printed circuit terminal blocks, grid 5  
for soldering into the PCB  
(see catalog page 290)

**EMG-GKS** component marking plate

**EM-AD/NS 32** cover, to snap the module  
onto mounting rails,  
15 mm (.445) wide

**EMG-ADM** cover for direct fitting  
15 mm (.492) wide

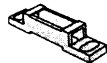
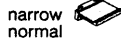

Type	Order No.	Pcs./Pkt.	Type	Order No.	Pcs./Pkt.
Grid 5 <b>EMG 25-LG</b>	29 48 31 9	5	<b>EMG 30-LG</b>	29 47 86 0	5
<b>EMG 25-B4</b>	29 48 33 5	5	<b>EMG 30-B5</b>	29 47 87 3	5
clear <b>EMG 25-H 7.5 mm clear</b>	29 47 13 2	10	clear <b>EMG 30-H 7.5 mm clear</b>	29 47 88 6	5
clear <b>EMG 25-H 15 mm clear</b>	29 48 32 2	10	clear <b>EMG 30-H 15 mm clear</b>	29 47 89 9	5
green <b>EMG 25-H 52 mm green</b>	29 47 14 5	10	green <b>EMG 30-H 52 mm green</b>	29 47 90 9	5
<b>P1-EMG 25</b>	29 47 19 0	5	<b>P1-EMG 30</b>	29 47 91 2	5
2 position <b>MKDS 3/2</b>	17 11 02 6	50	2 position <b>MKDS 3/2</b>	17 11 02 6	50
3 position <b>MKDS 3/3</b>	17 11 03 9	50	3 position <b>MKDS 3/3</b>	17 11 03 9	50
4 position <b>MKDS 3/4</b>	17 11 04 2	50	4 position <b>MKDS 3/4</b>	17 11 04 2	50
<b>EMG-GKS</b>	29 47 03 5	50	<b>EMG-SGKS</b>	29 47 58 5	50
<b>EM-AD/NS 32</b>	29 49 83 9	10	<b>EMG-GKS</b>	29 47 03 5	50
<b>EMG-ADM</b>	29 48 59 7	10	<b>EM-AD/NS 32</b>	29 49 83 9	10

Power loss dependent upon the cover  
height at 20° C

Module mounted with zero spacing

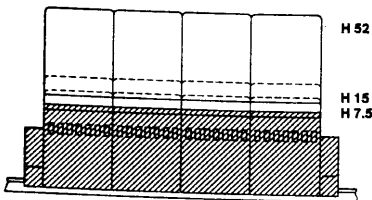

Power loss [W] at 20° C

	EMG 25	EMG 30	EMG 37	EMG 45	EMG 50
H 7.5 mm	1.4	1.5	1.6	2.0	2.3
H 15 mm	1.6	1.7	1.9	2.5	2.8
H 52 mm	2.3	2.4	2.6	3.5	3.8

Reduction factor dependent upon the ambient  
temperature

As the maximum permissible power loss is reduced with an  
increase in the ambient temperature, the listed reduction  
factor (K<sub>f</sub>) must be taken into account when calculating  
the permissible power loss.

K <sub>f</sub>	Ambient temperature [° C]				
	20	30	40	50	60
	1	0.8	0.64	0.51	0.41

Module mounted with a spacing of ≥ 20 mm (.787)

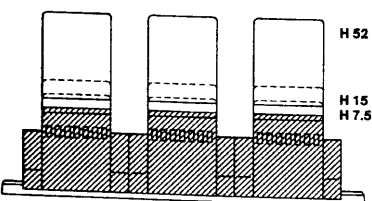

Power loss [W] at 20° C

	EMG 25	EMG 30	EMG 37	EMG 45	EMG 50
H 7.5 mm	1.6	1.7	1.8	2.4	2.6
H 15 mm	1.8	1.9	2.1	2.9	3.4
H 52 mm	2.9	3.1	3.5	4.4	4.8

### EMG 37

37.5 mm wide, 14 position

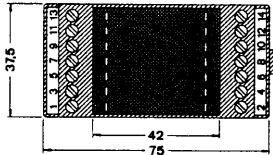
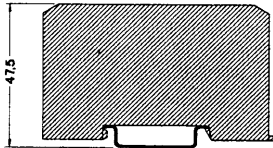

	[mm <sup>2</sup> ]	AWG
Connection data, fine strand	2,5	12
Connection data, solid strand	4	12

### EMG 45

45 mm wide, 16 position

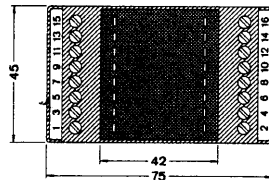
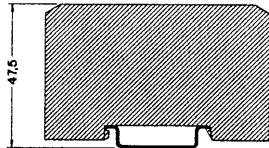

	[mm <sup>2</sup> ]	AWG
Connection data, fine strand	2,5	12
Connection data, solid strand	4	12

### EMG 50

50 mm wide, 18 position

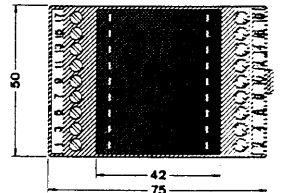
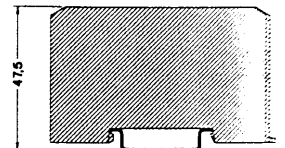

	[mm <sup>2</sup> ]	AWG
Connection data, fine strand	2,5	12
Connection data, solid strand	4	12

Type	Order No.	Pcs. Pkt.	Type	Order No.	Pcs. Pkt.	Type	Order No.	Pcs. Pkt.
MG 37-LG	29 47 05 1	5	EMG 45-LG	29 46 19 1	5	EMG 50-LG	29 47 24 2	5
MG 37-B7	29 47 06 4	5	EMG 45-B8	29 46 20 1	5	EMG 50-B9	29 47 25 3	5
MG 37-H 7.5 mm clear	29 47 15 8	5	EMG 45-H 7.5 mm clear	29 46 21 4	5	EMG 50-H 7.5 mm clear	29 47 92 5	5
MG 37-H 15 mm clear	29 47 16 1	5	EMG 45-H 15 mm clear	29 46 22 7	5	EMG 50-H 15 mm clear	29 47 93 3	5
MG 37-H 52 mm green	29 47 17 4	5	EMG 45-H 52 mm green	29 46 23 0	5	EMG 50-H 52 mm green	29 47 94 1	5
1-EMG 37	29 47 07 7	5	P1-EMG 45	29 46 24 3	5	P1-EMG 50	29 47 25 3	5
IKDS 3/2	17 11 02 8	50	MKDS 3/2	17 11 02 6	50	MKDS 3/2	17 11 02 6	50
IKDS 3/3	17 11 03 9	50	MKDS 3/3	17 11 03 9	50	MKDS 3/3	17 11 03 9	50
IKDS 3/4	17 11 04 2	50	MKDS 3/4	17 11 04 2	50	MKDS 3/4	17 11 04 2	50
MG-GKS	29 47 03 5	50	EMG-GKS	29 47 03 5	50	EMG-GKS	29 47 03 5	50

Power loss dependent upon the ambient temperature and cover height

$$\gamma_{tu} = P_{vt} \times K_j$$

Explanations:  $P_v$  = power loss  
 $t_u$  = ambient temperature  
 $t = 20^\circ\text{C}$   
 $K_j$  = reduction factor

Example:

Power loss at  $40^\circ\text{C}$  in EMG 25, mounted without spacing, cover height H 15 mm

$$\gamma_{40^\circ\text{C}} = P_v 20^\circ\text{C} \times K_j = 1.6\text{ W} \times 0.64 = 1.02\text{ W}$$

Dimensional drawing of electronic module EMG

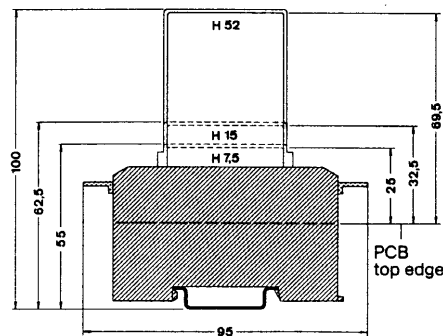

mm to inch	
47.5	= (1.870)
7.5	= (.295)
5	= (.197)
15	= (.591)
10	= (.394)
12.5	= (.492)
17.5	= (.689)
12	= (.472)
5	= (.197)
50	= (1.968)
52	= (2.047)
55	= (2.165)
62.5	= (2.461)
69.5	= (2.736)
75	= (2.953)
95	= (3.740)
100	= (3.937)

# Electronic Modules EMG or Custom Circuits

**EMG 75**  
75 mm wide, 28 position

**EMG 90**  
90 mm wide, 34 position

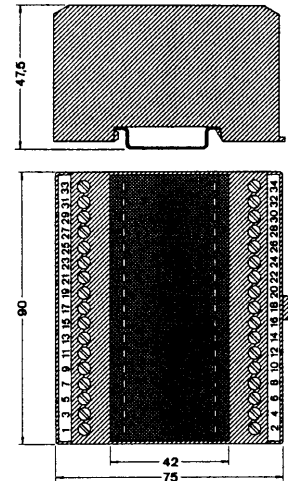
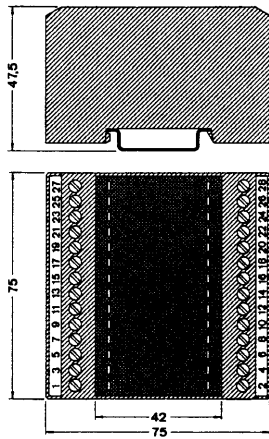

	[mm <sup>2</sup> ]	AWG
Connection data, fine strand	2.5	12
Connection data, solid strand	4	12

	[mm <sup>2</sup> ]	AWG
Connection data, fine strand	2.5	12
Connection data, solid strand	4	12

Description	Type	Order No.	Pcs. Pkt.	Type	Order No.	Pcs. Pkt.	
Empty module, for PCB insertion Hour screw connection Terminal block and cover	Grid 5	<b>EMG 75-LG</b>	29 47 37 8	5	<b>EMG 90-LG</b>	29 46 25 6	2
Custom circuit module, consisting of housing, connection terminal block MKDS 3 and PCB with points soldering in electronic components		<b>EMG 75-B14</b>	29 47 38 1	2	<b>EMG 90-B17</b>	29 46 26 9	5
Cover, to protect components from contact and contamination. Available in green or clear. Dimensional drawing see page 13	clear clear green	<b>EMG 75-H 7.5 mm clear</b> <b>EMG 75-H 15 mm clear</b> <b>EMG 75-H 52 mm green</b>	29 47 95 4 29 47 96 7 29 47 97 0	5 5 5	<b>EMG 90-H 7.5 mm clear</b> <b>EMG 90-H 15 mm clear</b> <b>EMG 90-H 52 mm green</b>	29 45 39 6 29 45 40 6 29 44 30 0	5 5 5
Printed circuit board, accepting electronic components (see page 18-19)		<b>P1-EMG 75</b>	29 47 39 4	5	<b>P1-EMG 90</b>	29 46 27 2	5
Printed circuit terminal blocks, grid 5, soldering into the PCB (see page 290)	2 position 3 position 4 position	<b>MKDS 3/2</b> <b>MKDS 3/3</b> <b>MKDS 3/4</b>	17 11 02 6 17 11 03 9 17 11 04 2	50 50 50	<b>MKDS 3/2</b> <b>MKDS 3/3</b> <b>MKDS 3/4</b>	17 11 02 6 17 11 03 9 17 11 04 2	50 50 50
Component marking plate		<b>EMG-GKS</b>	29 47 03 5	50	<b>EMG-GKS</b>	29 47 03 5	50

Power loss dependent upon the cover  
height at 20° C

Mounted with zero spacing

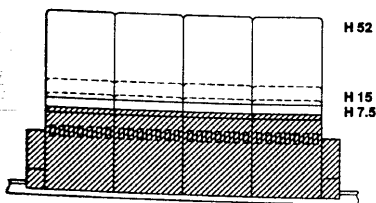

Power loss [W] at 20° C

	EMG 75	EMG 90	EMG 100	EMG 125	EMG 150
H 7.5 mm	3.3	4.1	-	-	-
H 15 mm	3.8	5.0	-	-	-
H 52 mm	4.9	6.1	-	-	-

Reduction factor dependent upon the ambient  
temperature

As the maximum permissible power loss is reduced with an  
increase in the ambient temperature, the listed reduction  
factor (K<sub>f</sub>) must be taken into account when calculating  
the permissible power loss.

Ambient temperature [° C]

	20	30	40	50	60
K <sub>f</sub>	1	0.8	0.64	0.51	0.41

Mounted with a spacing of ≥ 20 mm ( .787)

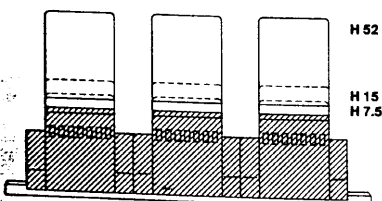

Power loss [W] at 20° C

	EMG 75	EMG 90	EMG 100	EMG 125	EMG 150
H 7.5 mm	3.9	4.6	-	-	-
H 15 mm	4.8	5.7	-	-	-
H 52 mm	5.8	7.1	-	-	-

**EMG 100**  
100 mm wide, 38 position

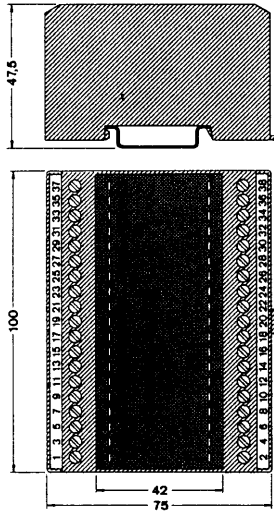

	[mm <sup>2</sup> ]	AWG
Connection data, fine strand	2.5	12
Connection data, solid strand	4	12

**EMG 125**  
125 mm wide, 48 position

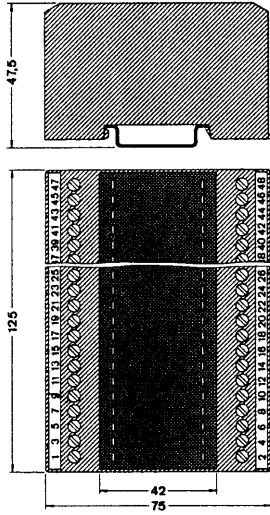

	[mm <sup>2</sup> ]	AWG
Connection data, fine strand	2.5	12
Connection data, solid strand	4	12

**EMG 150**  
150 mm wide, 58 position

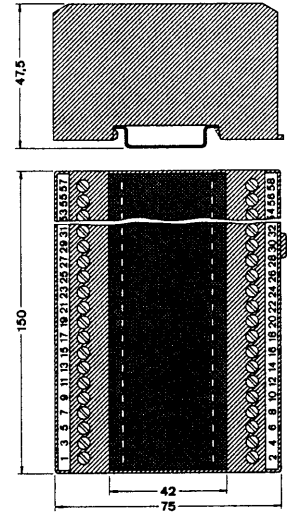

	[mm <sup>2</sup> ]	AWG
Connection data, fine strand	2.5	12
Connection data, solid strand	4	12

Type	Order No.	Pcs./Pkt.	Type	Order No.	Pcs./Pkt.	Type	Order No.	Pcs./Pkt.
EMG 100-LG	29 47 08 0	2	EMG 125-LG	29 47 98 3	2	EMG 150-LG	29 46 02 3	2
EMG 100-B19	29 47 09 3	2	EMG 125-B24	29 47 99 6	2	EMG 150-B29	29 46 03 6	2
on request			on request			on request		
P1-EMG 100	29 47 10 3	5	P1-EMG 125	29 46 01 0	5	P1-EMG 150	29 46 04 9	5
MKDS 3/2	17 11 02 6	50	MKDS 3/2	17 11 02 6	50	MKDS 3/2	17 11 02 6	50
MKDS 3/3	17 11 03 9	50	MKDS 3/3	17 11 03 9	50	MKDS 3/3	17 11 03 9	50
MKDS 3/4	17 11 04 2	50	MKDS 3/4	17 11 04 2	50	MKDS 3/4	17 11 04 2	50
EMG-GKS	29 47 03 5	50	EMG-GKS	29 47 03 5	50	EMG-GKS	29 47 03 5	50

Power loss dependent upon the ambient temperature and cover height

$$P_{vtu} = P_{vt} \times K_f$$

Explanations:  $P_v$  = power loss  
 $t_u$  = ambient temperature  
 $t = 20^\circ\text{C}$   
 $K_f$  = reduction factor

Example:  
 Power loss at  $40^\circ\text{C}$  in EMG 90; mounted without spacing; cover height H 15 mm

$$P_{v40^\circ\text{C}} = P_{v20^\circ\text{C}} \times K_f = 5.0\text{ W} \times 0.64 = 3.2\text{ W}$$

Dimensional drawing of electronic module EMG

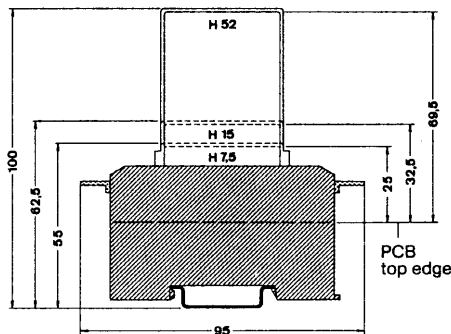

mm to inch	
7.5 = (.295)	62.5 = (2.461)
15 = (.590)	69.5 = (2.736)
25 = (.984)	75 = (2.953)
32.5 = (1.279)	90 = (3.543)
42 = (1.653)	95 = (3.740)
47.5 = (1.870)	100 = (3.937)
52 = (2.047)	125 = (4.921)
55 = (2.165)	150 = (5.905)

# Electronic Module EMK for Custom Circuits



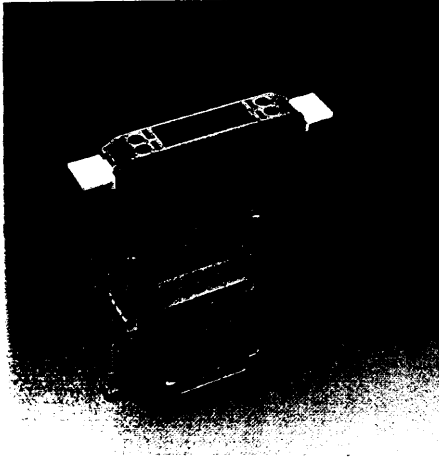

**EMK 12**  
12.5 mm wide, 4 positions

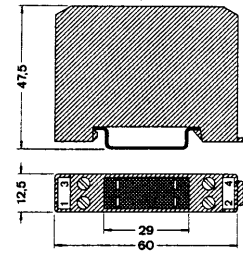

The special feature of the electronic module EMK is its compact design with only 12.5 mm construction width.



	[mm <sup>2</sup> ]	AWG
Connection data, fine strand	2.5	12
Connection data, solid strand	4	12

Description	Type	Order No.	Pcs. Ptk.
<b>Empty module</b> , for PCB insertion, without screw connection terminal block	EMK 12-LG	29 48 98 2	10
<b>Custom circuit module</b> , consisting of housing, connection terminal blocks MKDS 3 and PCB with points for soldering in electronic components	EMK 12-B2	29 48 99 5	10
<b>Printed circuit board</b> , to mount electronic components (see page 19)	P1-EMK 12	29 47 01 9	5
<b>Printed circuit terminal blocks</b> , for soldering into the PCB (also see catalog page 290)	2 positions MKDS 3/2	17 11 02 6	50
<b>Equipment marking plate</b>	 EMG-GKS	29 47 03 5	50
<b>Adaptor</b> , to snap the module on  mounting rails, 11.4 mm ( .445) wide	 EM-AD/NS 32	29 49 83 9	10
<b>Adaptor</b> for direct fitting 12.5 mm ( .492) wide	 EMG-ADM	29 48 59 7	10

**mm to inch**  
12.5=(.492)  
29 =(1.142)  
47.5=(1.870)  
60 =(2.362)

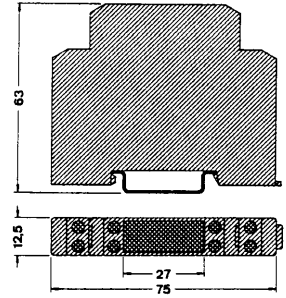
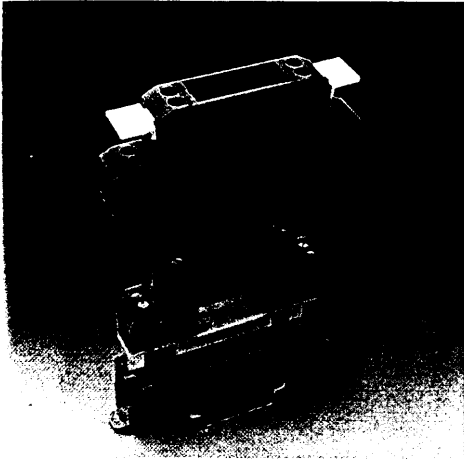

# DOUBLE Level Electronic Module EMD for Custom Circuits

**EMD 12**  
12.5 mm wide, 8 position



The module type EMD offers 8 connection points in a double level arrangement with a construction width of only 12.5 mm.

	[mm <sup>2</sup> ]	AWG
Connection data, fine strand	2.5	12
Connection data, solid strand	4	12

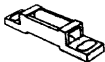
Description	Type	Order No.	Pcs/Pkt
<b>Empty module</b> , for PCB insertion, without screw connection terminal blocks and cover	<b>EMD 12-LG</b>	<b>29 47 40 4</b>	10
<b>Cover</b> , to protect components from contact and contamination	<b>on request</b>		
<b>Printed circuit terminal blocks</b> , for soldering in the PCB, bottom lower level	2 positions <b>MKDS 3/2</b>	<b>17 11 02 6</b>	50
<b>Printed circuit terminal blocks</b> , for soldering in the PCB upper level	2 positions <b>MKKDHS 3/2</b>	<b>17 21 04 5</b>	50
<b>Spacer</b> , plastic for the printed circuit terminal blocks MKKDSH	<b>AH-MKKDHS 3/2</b>	<b>17 21 78 6</b>	50
<b>Equipment marking plate</b>	 <b>EMG-GKS</b>	<b>29 47 03 5</b>	50
<b>Adaptor</b> , to snap the modules on  mounting rails, 11.4 mm (.445) wide	 <b>EM-AD/NS 32</b>	<b>29 49 83 9</b>	10
<b>Adaptor</b> for direct fitting 12.5 mm (.492) wide	 <b>EMG-ADM</b>	<b>29 48 59 7</b>	10

**mm to inch**  
12.5 = (.492)  
27 = (1.063)  
63 = (2.480)  
75 = (2.953)

**Double Level  
Electronic Module EME  
for Custom Circuits**

**EME 45**  
45 mm wide, 16 position

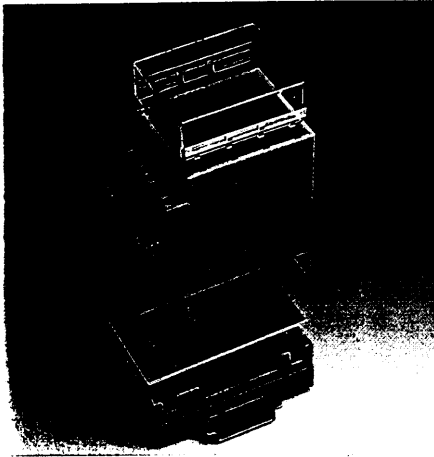

The module type EME offers an enlarged custom circuit space. The 16 connection points are arranged on only one side of the module on both levels as input or output terminal blocks.

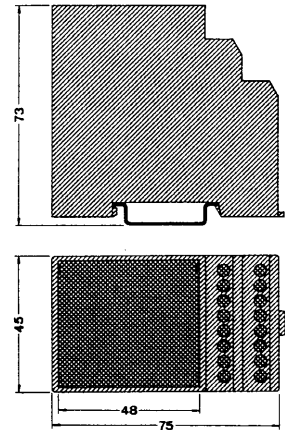

	[mm <sup>2</sup> ]	AWG
Connection data, fine strand	2.5	12
Connection data, solid strand	4	12

Description	Type	Order No.	Pcs. Ptk.
Empty module, for PCB insertion, without screw connection terminal blocks and cover	EME 45-LG	29 44 11 9	10
Cover, to protect components from contact and contamination. Available in green or clear, see below for dimensions	clear	EMG 50-H 7.5 mm clear	29 47 92 5
	clear	EMG 50-H 15 mm clear	29 47 93 8
	green	EMG 50-H 52 mm green	29 47 94 1
Printed circuit terminal blocks, grid 5, for soldering in the PCB	2 position	MKKDSG 3/2	17 21 09 0
	3 position	MKKDSG 3/3	17 21 08 7

**Dimensional drawing of electronic module EME**

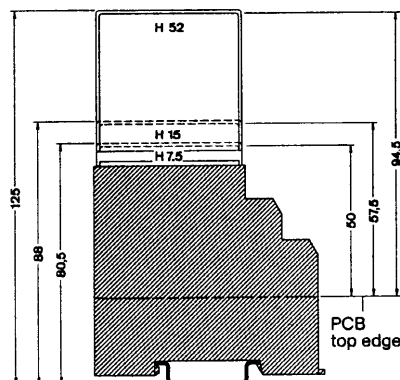

**mm to inch**

7.5	= (.295)
15	= (.590)
45	= (1.772)
48	= (1.890)
50	= (1.968)
52	= (2.047)
57.5	= (2.264)
73	= (2.874)
75	= (2.953)
80.5	= (3.169)
88	= (3.464)
94.5	= (3.720)
125	= (4.921)



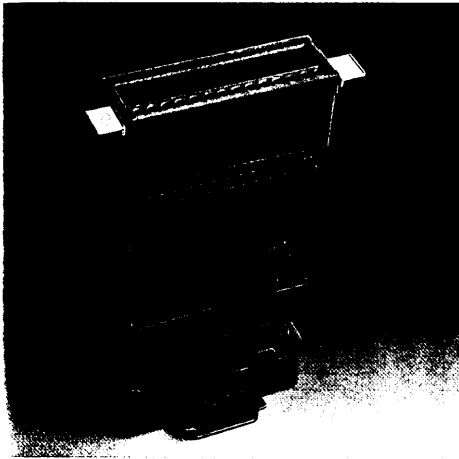

These component housings with front connection system have a variable construction height. With a construction width of only 25 mm, the required module height and thus the custom circuit space can be flexibly varied by the use of intermediate elements. In this manner the vertically arranged PCB in the module can be matched to the individual switching task. 14 individual printed circuit terminals with front connection are fitted in the module. Each connection point can also be allocated a light indicator.

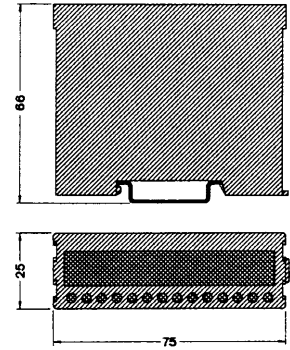

	[mm <sup>2</sup> ]	AWG
Connection data, fine strand	1.5	16
Connection data, solid strand	1.5	16

Description	Type	Order No.	Pcs Pkt
<b>Empty module</b> , for PCB insertion, without screw connection terminal blocks	<b>EMH 25-LG</b>	<b>29 44 12 2</b>	10
<b>Intermediate elements</b> , for the empty module intermediate element, 18 mm high	<b>EMH 25-ZE 18</b>	<b>29 44 13 5</b>	10
intermediate element, 30 mm high	<b>EMH 25-ZE 30</b>	<b>29 44 14 8</b>	10
<b>Single printed circuit terminal block</b> , for front connection, 5 mm grid, pin spacing 5 mm	<b>FRONT 1.5H/SA5</b>	<b>17 00 00 8</b>	50
pin spacing 10 mm	<b>FRONT 1.5H/SA10</b>	<b>17 00 04 0</b>	50
<b>End cover</b> , necessary at the end of a terminal block row, 2,5 mm thick, color: green	<b>D-FRONT 1.5H</b>	<b>17 00 02 4</b>	50
<b>Equipment marking plate</b>	<b>EMG-GKS</b>	<b>29 47 03 5</b>	50
<b>Adaptor</b> to snap the module on  mounting rails, 11,4 ( .445) mm wide	<b>EM-AD/NS 32</b>	<b>29 49 83 9</b>	10
<b>Adaptor</b> for direct fitting 12,5 ( .492) mm wide	<b>EMG-ADM</b>	<b>29 48 59 7</b>	10

Dimensional drawing of electronic module EMH

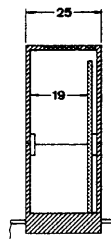

**mm to inch**  
19=(.748)  
25=(.984)  
66=(2.598)  
75=(2.953)

# Printed Circuit Board Layouts for the Electronic Modules EMG, EMK, EMD, EME and MH in a 1:1 Scale

## Technical data for the printed circuit board

PCB material: Epoxy glass filament fabric  
 Thickness: 1.5 mm (.026) thick as per DIN 40802  
 Copper plating: 70 µm  
 Holes: 1.3 mm (.051) dia. for the solder pins of the screw and tab connections  
 0.9 mm (.035) dia. for components as per DIN 40801 page 2  
 Creepage distance: 250 V AC as per VDE 0110/Gr. C  
 VDE 0160

TF: Top face  
 BF: Bottom face  
 in: internal

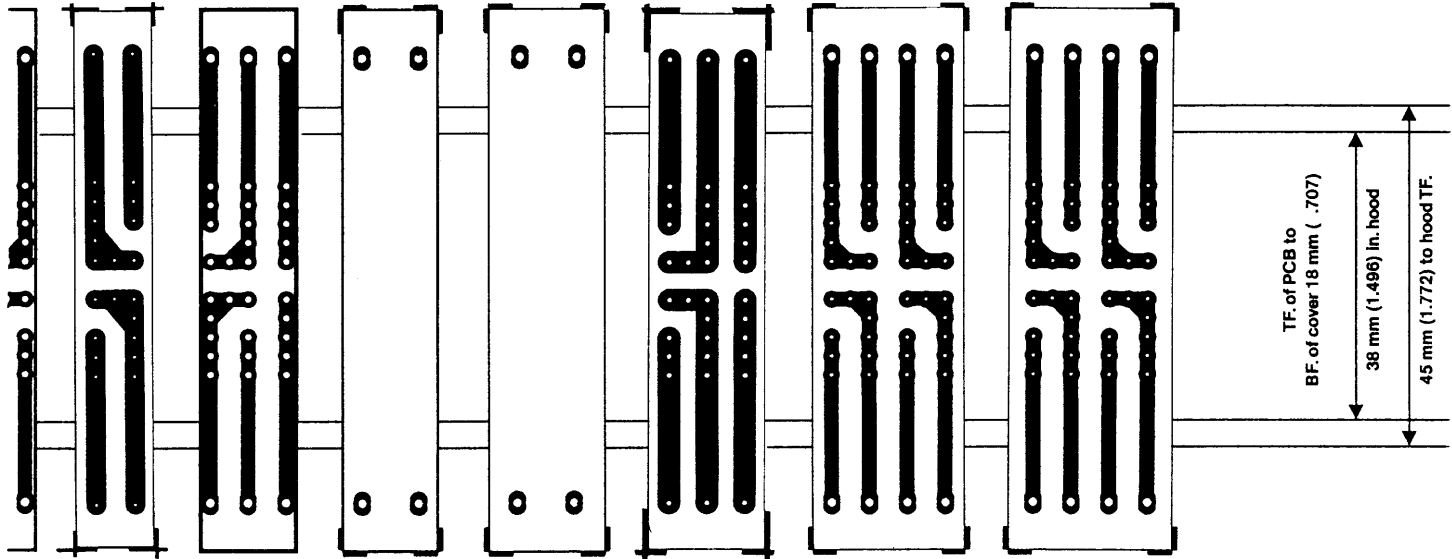

G 10 EMG 12 EMG 15 EMG15R.7.5 EMG17R.7.5 EMG 17 EMG 22 EMG 25

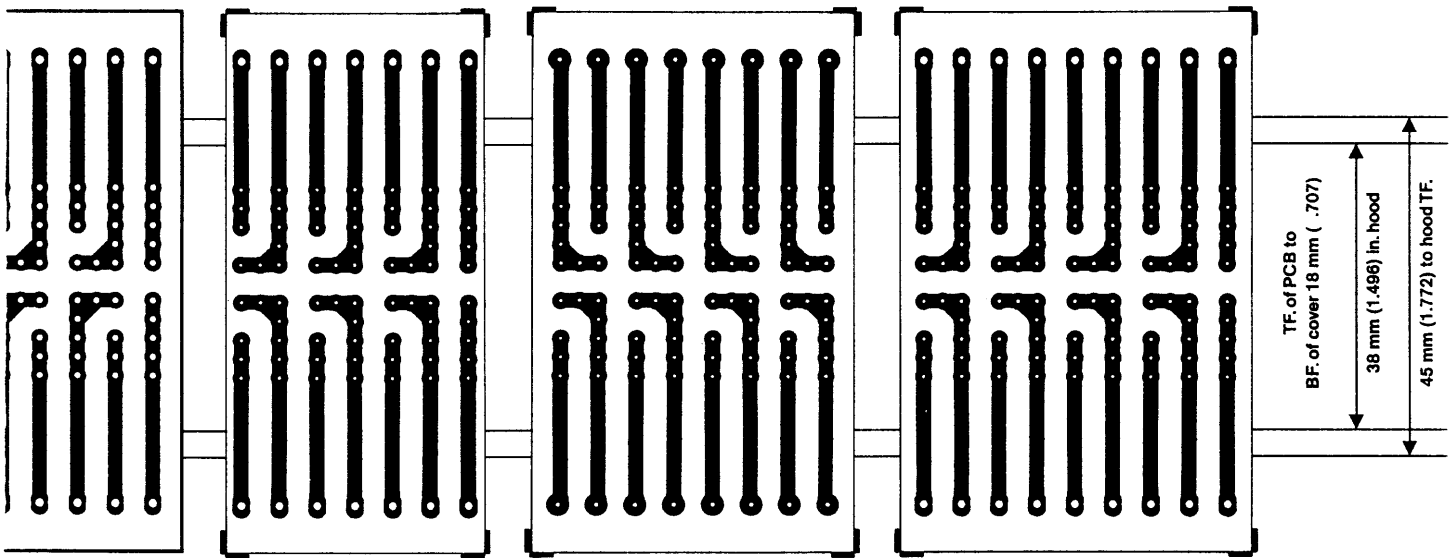

EMG 30 EMG 37 EMG 45 EMG 50

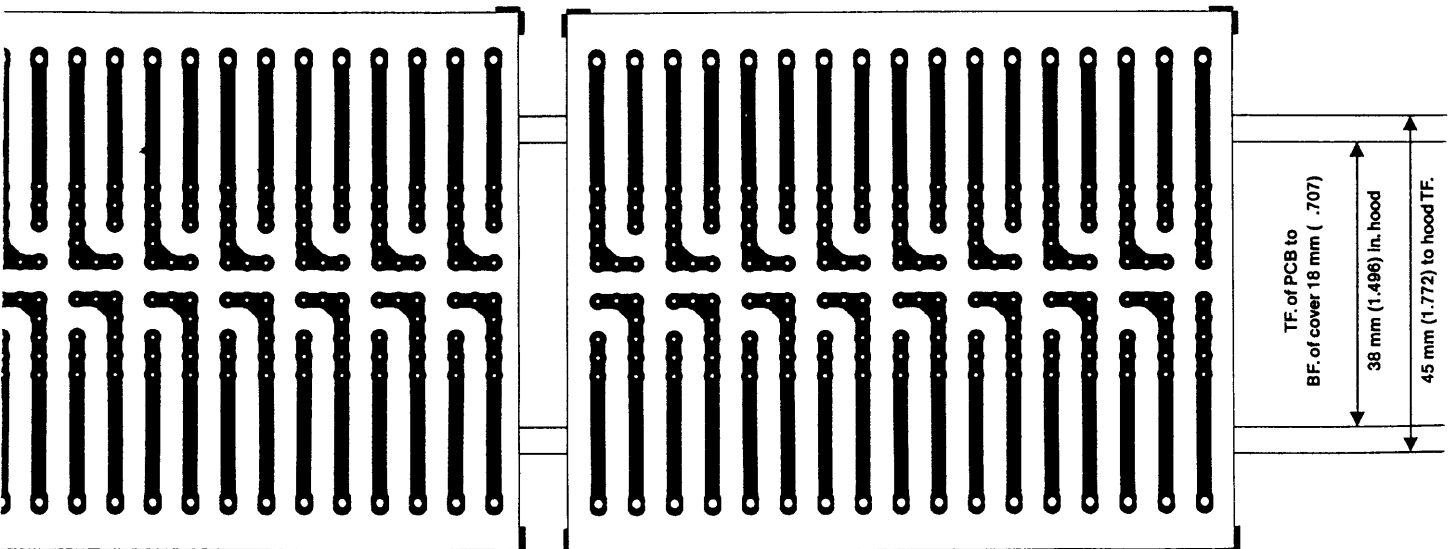

EMG 75 EMG 90

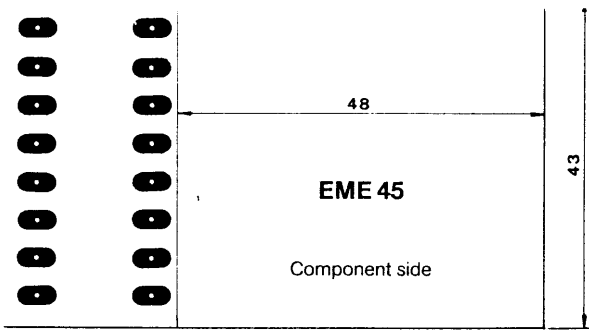

mm to inch  
 10=(.394)  
 27=(1.063)  
 29=(1.142)  
 38=(1.496)  
 43=(1.693)  
 47=(1.850)  
 48=(1.890)  
 60=(2.362)

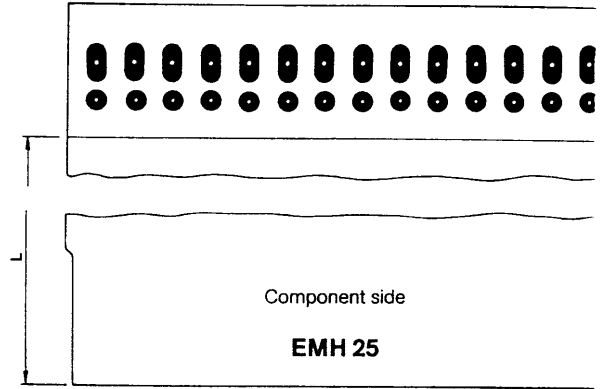
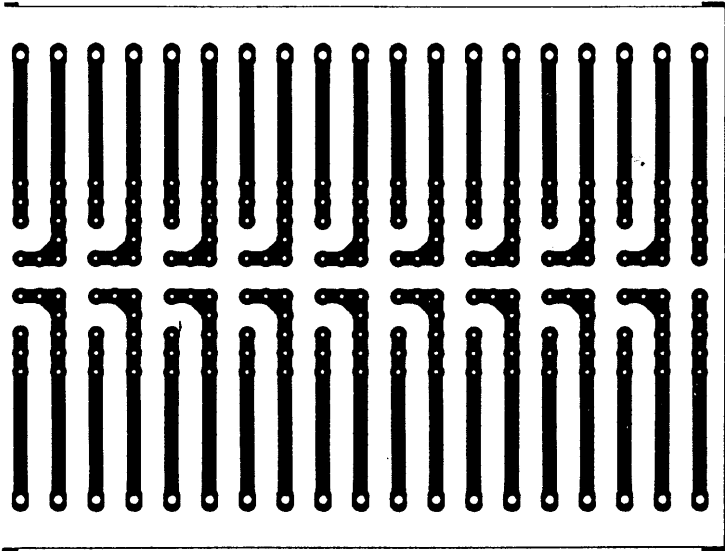
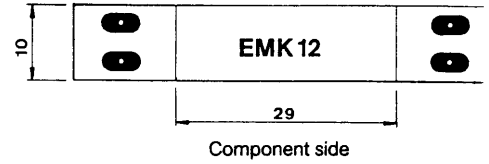
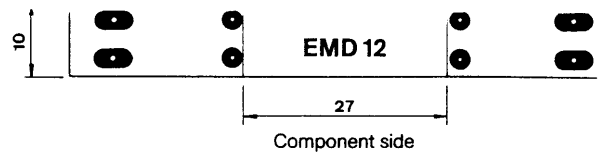

List of electronic modules EMH

Total length	Width	Component length L	Width
53 mm (2.087)	72 mm (2.835)	35 mm (1.378)	72 mm (2.83)
71 mm (2.795)	72 mm (2.835)	53 mm (2.087)	72 mm (2.83)
83 mm (3.268)	72 mm (2.835)	65 mm (2.559)	72 mm (2.83)
101 mm (3.976)	72 mm (2.835)	83 mm (3.268)	72 mm (2.83)
113 mm (4.449)	72 mm (2.835)	95 mm (3.740)	72 mm (2.83)
131 mm (5.157)	72 mm (2.835)	113 mm (4.449)	72 mm (2.83)
143 mm (5.629)	72 mm (2.835)	125 mm (4.921)	72 mm (2.83)

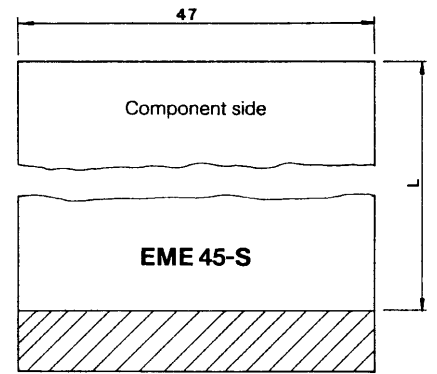
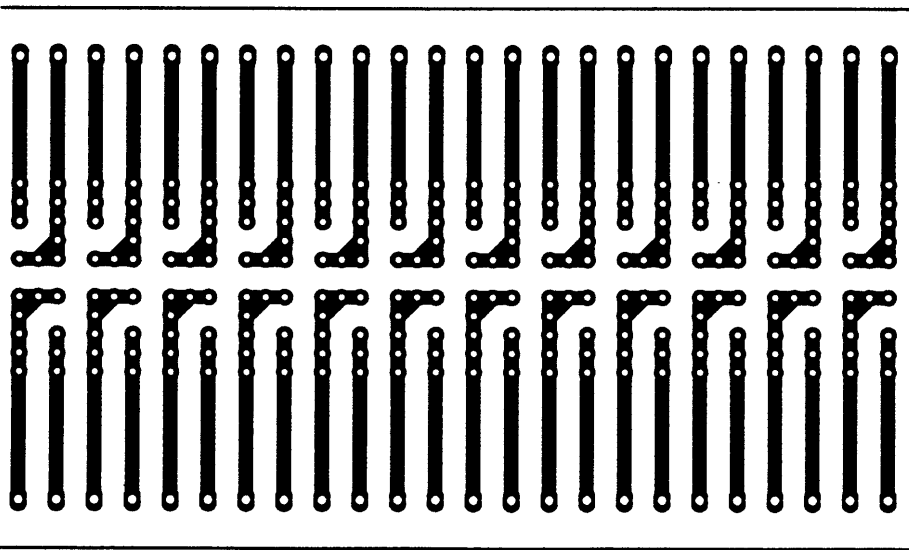

PCB dimensions when using different covers

Total length	Width	Component length L	Width	Covers
49 mm (1.929)	47 mm*	41 mm (1.614)	47 mm*	EMG 50-H 7
57 mm (2.244)	47 mm*	49 mm (1.929)	47 mm*	EMG 50-H 1
94 mm (3.701)	47 mm*	36 mm (1.417)	47 mm*	EMG 50-H 5
	*(1.850)		*(1.850)	
	*(1.850)		*(1.850)	
	*(1.850)		*(1.850)	

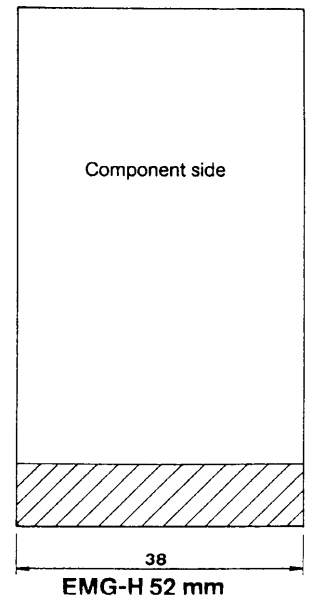
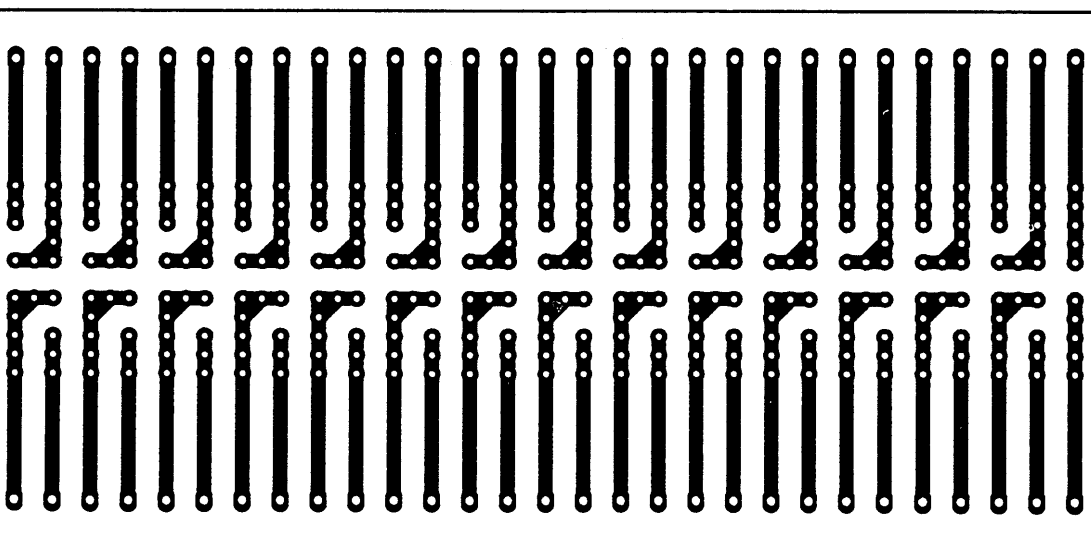

# Electronic Component Housings UEG Custom Circuits

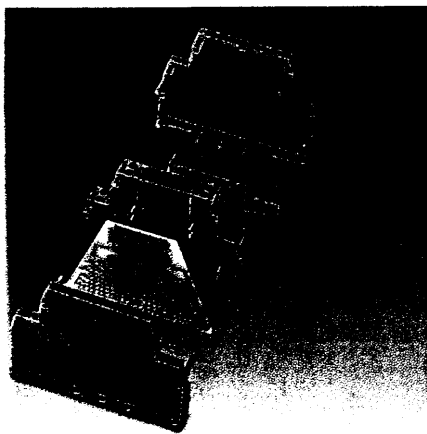

The electronic component housing UEG is produced in two widths (20 and 30 mm) and is available with screw or tab connections. The housing can be engaged on commercially available DIN mounting rails.

The functional housing concept permits an economical production of series quantities. In one work cycle the basic element of the connections and the custom circuit board are machine soldered and subsequently securely engaged with the housing shells to form a housing. Due to the available level 8 or 16 screw or tab connections and the installation of one or two printed circuit boards even complex electronic circuits can be accommodated in the housing.

For laboratory samples and small series a universal printed circuit board is available.

For technical data and of the printed circuit board dimensions refer to page 26.

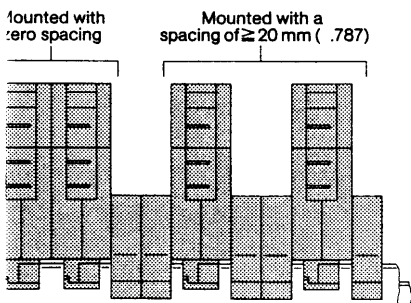

## Type of moldings

**Material** = Polyamide 6.6, see catalog page 12  
Color: green

Marking and mounting material see catalog page 10

## UEG 20 8 position component holder with screw connection

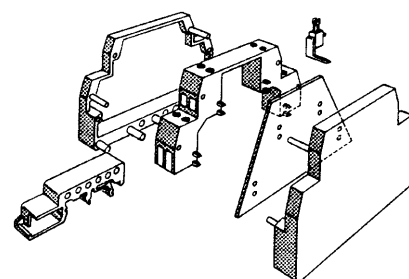
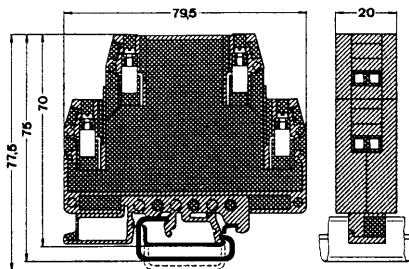

	Solid	fine strand, AWG	I [mm <sup>2</sup> ]	I [A]	VAC [V]
Screw connection	4	2.5	12	10*	250*
Tab connection: 6.3/2.8 mm					
UEG 20-FS/FS				10/5*	500*
UEG 30/1-FS/FS				10/5*	500*
UEG 30/2-FS/FS				10/5*	250*

\* The rated voltage applies to fully insulated receptacles and free solder connection. Voltage and current values are affected by the configuration of the printed circuit board.



## Description

**Electronic component housing, 20 mm wide, complete,** equipped with 4 screw or 4 tab connections per side, for one printed circuit board

**Electronic component housing, 30 mm wide, complete,** equipped with 4 screw or 4 tab connections per side, for one printed circuit board

**Electronic component housing, 30 mm wide, complete,** equipped with 8 screw or 8 tab connections per side, for two printed circuit boards

**Printed circuit board,** for custom circuiting electronic components (see page 26)

**Plastic sheath,** as shock protection, slide onto conductor for 6.3 mm receptacles before fitting for 2.8 mm receptacles

**Wire bridge,** 50 position, divisible, for bridging identical inputs and outputs, 0.5 mm<sup>2</sup>, insulation: black or gray

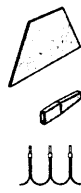

## UEG 20

Type	Order No.	Pcs. Pkt.
UEG 20	27 90 21 1	10
P1-UEG	27 90 22 4	10
DB 50-90 black	28 20 91 6	1
DB 50-90 grey	28 20 92 9	1

## Power loss as a function of ambient temperature

Mounted with zero spacing  
Power loss [W] at 20° C

UEG 20	UEG 30/1	UEG 30/2	UEG 20-FS/FS	UEG 30/1-FS/FS	UEG 30/2-FS/FS
4	4	4	4.8	4.8	4.8

Mounted with spacing of ≥ 20 mm  
Power loss [W] at 20° C

UEG 20	UEG 30/1	UEG 30/2	UEG 20-FS/FS	UEG 30/1-FS/FS	UEG 30/2-FS/FS
6.4	7.2	7.2	8	8	8

## Reduction factor dependent upon the ambient temperature

As the maximum permissible power loss is reduced with an increase in the ambient temperature, the listed reduction factor (K<sub>t</sub>) must be taken into account when calculating the permissible power loss.

Ambient temperature [° C]	20	30	40	50	60	70	80
K <sub>t</sub>	1	0.78	0.61	0.48	0.37	0.29	0.23

## Power loss dependent upon the ambient temperature

$$P_{vtu} = P_{vt} \times K_t$$

**Explanations:** P<sub>v</sub> = power loss  
t<sub>u</sub> = ambient temperature  
t = 20° C  
K<sub>t</sub> = reduction factor

**Example:** Power loss at 40° C in UEG 20, mounted without spacing

$$P_v 40^\circ C = P_v 20^\circ C \times K_t = 4 W \times 0.61 = 2.44 W$$

## UEG 30

16 position component holder with screw connection

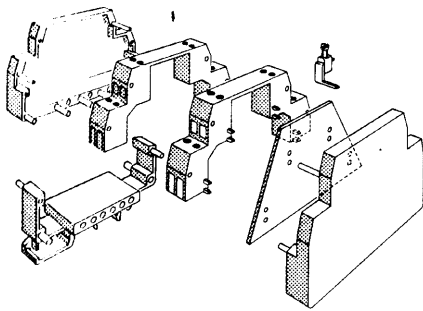
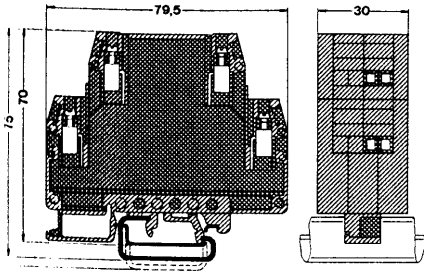

EG 30/1

## UEG 20-FS/FS

8 position component holder with slotted 6.3/2.8 mm tab connection

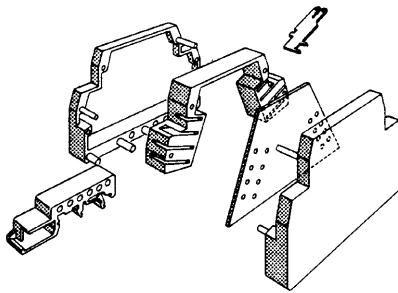
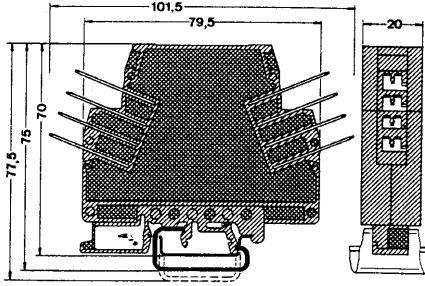

UEG 20-FS/FS

## UEG 30-FS/FS

8 and 16 position component holder with slotted 6.3/2.8 mm tab connection

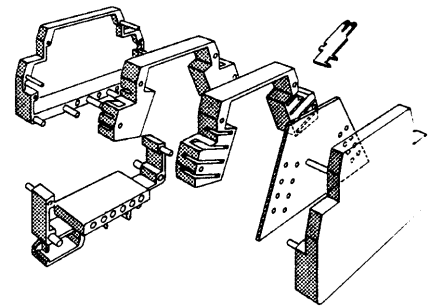
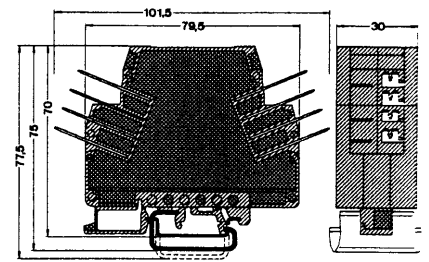

UEG 30/1-FS/FS

pe	Order No.	Pcs. Pkt.	Type	Order No.	Pcs. Pkt.	Type	Order No.	Pcs. Pkt.
			UEG 20-FS/FS	27 90 26 6	10			
EG 30/1	27 90 87 1	10				UEG 30/1-FS/FS	27 90 88 4	10
EG 30/2	27 90 24 0	10				UEG 30/2-FS/FS	27 90 27 9	10
I-UEG	27 90 22 4	10	P1-UEG-FS/FS	27 90 42 8	10	P1-UEG-FS/FS	27 90 42 8	10
			PT/FS-6.3	06 04 70 7	100	PT/FS-6.3	06 04 70 7	100
			PT/FS-2.8	14 06 70 0	100	PT/FS-2.8	14 06 70 0	100
8 50-80 black	28 20 91 6	1						
8 50-80 grey	28 20 92 9	1						

### Maximum component height on printed circuit board

UEG 20 with 1 printed circuit board, max. 8 positions	UEG 30/1 increased internal space with 1 printed circuit board, max. 8 position	UEG 30/2 increased internal space with 2 printed circuit boards, mirror image arrangement, max. 16 positions
12.5	22.5	19

### Maximum component height on printed circuit board

UEG 20-FS/FS with 1 printed circuit board, max. 8 positions	UEG 30/1-FS/FS increased internal space with 1 printed circuit board, max. 8 position	UEG 30/2-FS/FS increased internal space with 2 printed circuit boards, mirror image arrangement, max. 16 positions
12.5	22.5	19

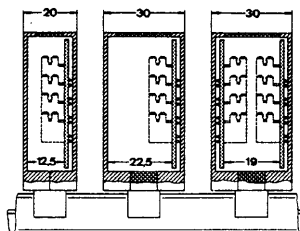
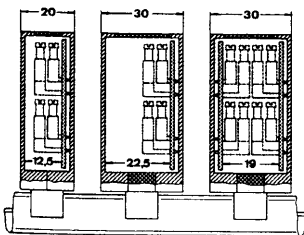

mm to inch

20	= (.787)
30	= (1.181)
70	= (2.756)
75	= (2.953)
77.5	= (3.051)
79.5	= (3.130)
101.5	= (3.996)

# Electronic Component Housings UEGM for Custom Circuits

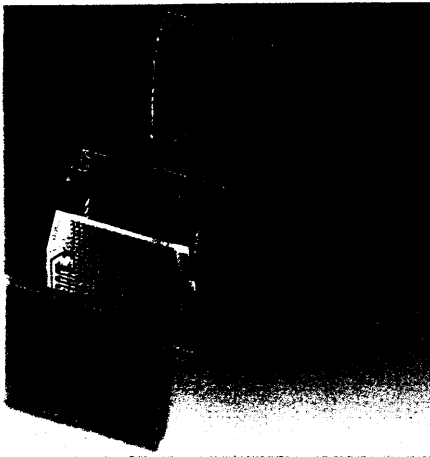

The electronic component housings UEGM supplement the UEG range and offer an enlarged internal area. The housing is available in the widths 22.5–25 and 40 mm. They can be individually provided with screw and/or tab connections. The housings snap on commercially available DIN EN mounting rails.

The functionable housing concept permits the economical production of series products. In one work cycle the basic element machine soldered with the connections of the custom circuited PCB and subsequently securely engaged with the housing will form a housing. Due to the double use of one or two printed circuit boards a complex electronic circuits can be accommodated in the housing.

For laboratory samples and small series a universal printed circuit board is available.

For technical data and printed circuit board dimensions refer to page 26.

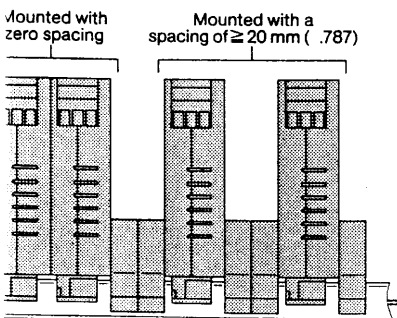

### Type of moldings

**Material** = Polyamide 6.6, see catalog page 12  
**Color**: green

Marking and mounting material see catalog page 10

### UEGM 6 position component holder with screw connection

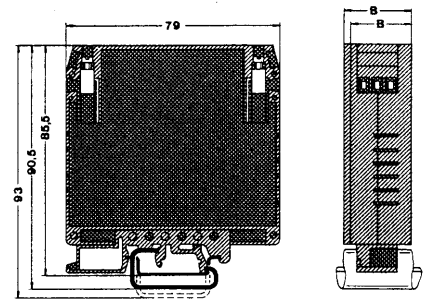

W = 22.5 with UEGM 22.5  
W = 25 with UEGM 25

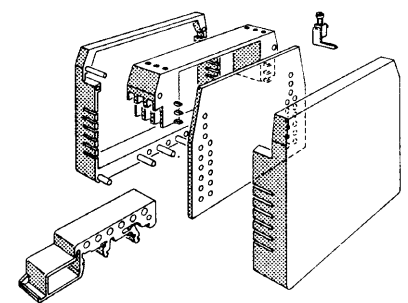

### UEGM 25

	Solid, [mm <sup>2</sup> ]	fine strand, AWG	I [A]	VAC [V]
Screw connection	4	2.5	12	10* 250*
Tab connection: 6.3/2.8 mm				10/5* 250*

\*The rated voltage applies to fully insulated receptacles and free solder connection. Voltage and current values are affected by the configuration of the printed circuit board.



### Description

**Electronic component housing, 22.5 mm wide, complete,** equipped with 3 screw or 6 tab connections per side, for one printed circuit board

**Electronic component housing,** as above, however, 25 mm wide

**Electronic component housing,** as above, however 40 mm wide

**Electronic component housing, 40 mm wide, complete,** equipped with 6 screw or 12 tab connections per side, for two printed circuit boards.

**Printed circuit board, for custom circuiting** electronic components (see page 26)

**Metal part for tab connection,** to increase the number of positions

**Plastic sheath, as shock protection,** slide onto conductor for 6.3 mm receptacles before fitting for 2.8 mm receptacles

**Wire bridge, 50 position, divisible** for bridging identical inputs and outputs, 0.5 mm<sup>2</sup>, insulation: black and grey



Type	Order No.	Pcs. Pkt.
UEGM 22.5	27 92 00 2	10
UEGM 25	27 92 01 5	10
P1-UEGM	27 92 10 9	10
UEG-MT-FS	27 90 38 9	100
PT/FS-6.3	06 04 70 7	100
PT/FS-2.8	14 06 70 0	100
DB 50-90 black	28 20 91 6	1
DB 50-90 grey	28 20 92 9	1

### Power loss as a function of ambient temperature

Mounted with zero spacing  
Power loss [W] at 20° C

UEGM 22.5	UEGM 25	UEGM 40/1	UEGM 40/2	UEGM 22.5-FS	UEGM 25-FS	UEGM 40/1-FS	UEGM 40/2-FS
4	4	5.2	5.2	4	4	5.2	5.2

Mounted with spacing of ≥ 20 mm  
power loss [W] at 20° C

UEGM 22.5	UEGM 25	UEGM 40/1	UEGM 40/2	UEGM 22.5-FS	UEGM 25-FS	UEGM 40/1-FS	UEGM 40/2-FS
10	10	11.2	11.2	10	10	11.2	11.2

### Reduction factor dependent upon the ambient temperature

As the maximum permissible power loss is reduced with an increase in the ambient temperature, the listed reduction factor (K<sub>t</sub>) must be taken into account when calculating the permissible power loss.

Ambient temperature [° C]	20	30	40	50	60	70	80
K <sub>t</sub>	1	0.8	0.64	0.51	0.41	0.33	0.26

### Power loss dependent upon the ambient temperature

$$P_{vtu} = P_{vt} \times K_t$$

**Explanations:** P<sub>v</sub> = power loss  
t<sub>u</sub> = ambient temperature  
t = 20° C  
K<sub>t</sub> = reduction factor

**Example:** Power loss at 40° C in UEGM 25, mounted without spacing

$$P_v 40^\circ C = P_v 20^\circ C \times K_t = 4 W \times 0.64 = 2.56 W$$

**UEGM**

and 12 position component holder with screw connection

**UEGM 13/15**

12 position component holder with slotted 6.3/2.8 tab connection

**UEGM 13/15**

12 and 24 position component holder with slotted 6.3/2.8 mm tab connection

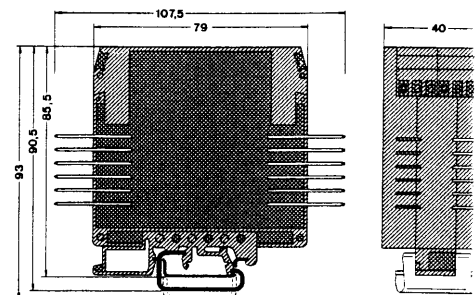
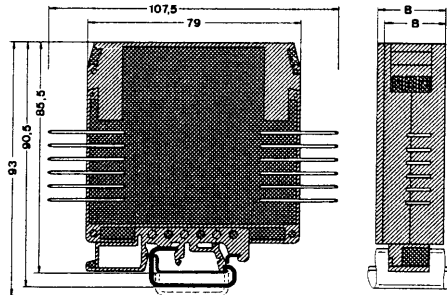
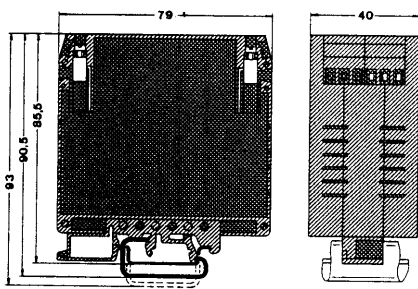

W=22.5 with UEGM 22.5  
W=25 with UEGM 25

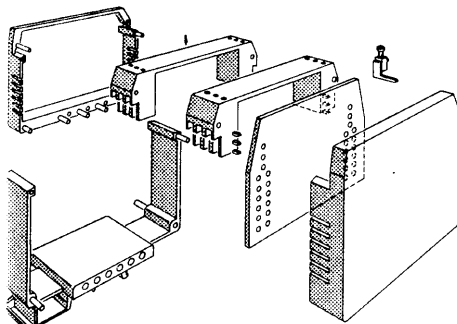

EGM 40/1

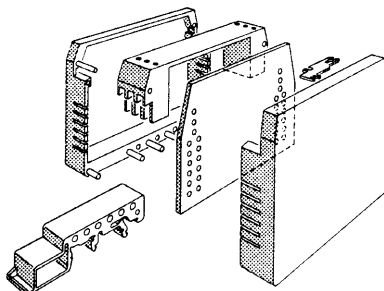

UEGM 25-FS/FS

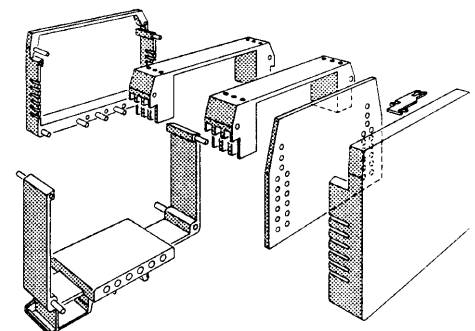

UEGM 40/1-FS/FS

pe	Order No.	Pcs. Pkt.	Type	Order No.	Pcs. Pkt.	Type	Order No.	Pcs. Pkt.
			UEGM 22.5-FS/FS	27 92 07 3	10			
			UEGM 25-FS/FS	27 92 08 6	10			
EGM 40/1	27 92 11 2	10				UEGM 40/1-FS/FS	27 92 12 5	10
EGM 40/2	27 92 02 8	10				UEGM 40/2-FS/FS	27 92 09 9	10
P1-UEGM	27 92 10 9	10	P1-UEGM	27 92 10 9	10	P1-UEGM	27 92 10 9	10
EG-MT-FS	27 90 38 9	100						
PT/FS-6.3	06 04 70 7	100	PT/FS-6.3	06 04 70 7	100	PT/FS-6.3	06 04 70 7	100
PT/FS-2.8	14 06 70 0	100	PT/FS-2.8	14 06 70 0	100	PT/FS-2.8	14 06 70 0	100
3 50-90 black	28 20 91 6	1						
B 50-90 grey	28 20 92 9	1						

179-054

**Maximum component height on printed circuit board**

**EGM 22.5** with 1 printed circuit board, 6 positions  
**UEGM 25** with 1 printed circuit board, 6 position  
**UEGM 40/1** increased internal space with 1 printed circuit board, 6 positions  
**UEGM 40/2** increased internal space with 2 printed circuit boards, image arrangement, 12 position

**Maximum component height on printed circuit board**

**UEGM 22.5-FS/FS** with 1 printed circuit board, 12 positions  
**UEGM 25-FS/FS** with 1 printed circuit board, 12 positions  
**UEGM 40/1-FS/FS** increased internal space with 1 printed circuit board, 12 position  
**UEGM 40/2-FS/FS** increased internal space with 2 printed circuit boards, image arrangement, 24 position

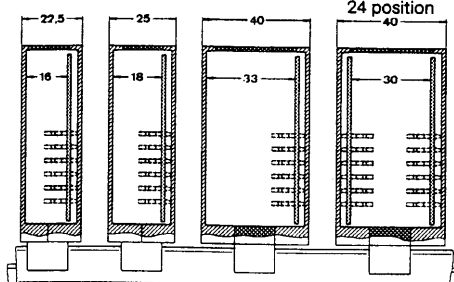
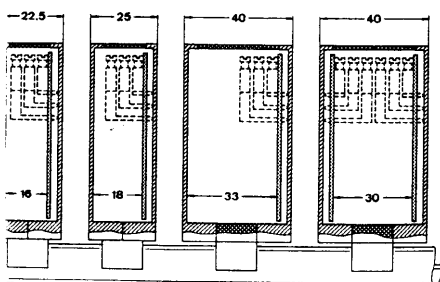

**mm to inch**

16	= (.630)
18	= (.709)
22.5	= (.886)
25	= (.984)
30	= (1.181)
33	= (1.299)
40	= (1.575)
79	= (3.110)
85.5	= (3.366)
90.5	= (3.563)
93	= (3.661)
107.5	= (4.232)

# Electronic Component Housing with 12 Position COMBICON Header UEGM-MSTB

UEGM-MSTB  
Component housing with COMBICON connection

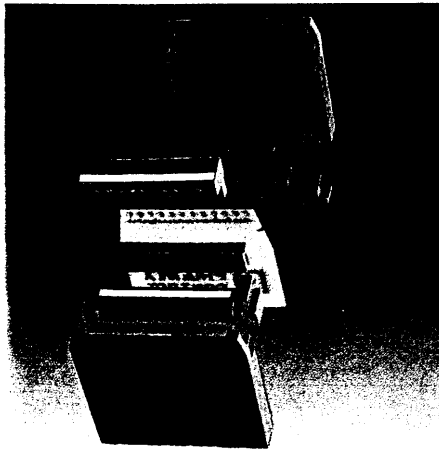

### Type of moldings

Material = Polyamide 6.6, see catalog page 12  
Color: green

Marking and mounting material see catalog page 10

Maximum component height on the printed circuit board

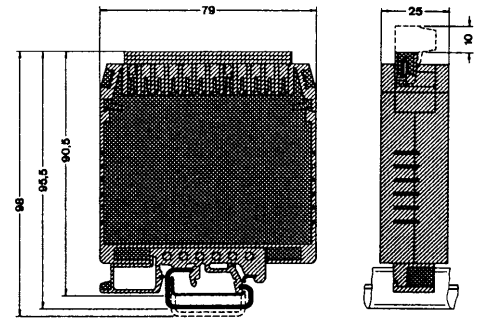
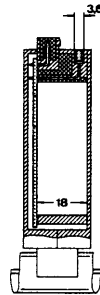

The special feature of this 25 mm wide electronic component housing UEGM-MSTB is the plug-in connection through a COMBICON plug connector 2 or 12 position. COMBICON plugs can be optionally integrated in the housing pin strip.

The COMBICON connection points can be individually fitted with 3 mm dia. LEDs and length 30 mm (1.181)]. The LED cut-outs in the housing not required can be closed with plugs. If several component housings with the same plug arrangement are arranged next to each other, the individuality of the COMBICON plugs can be ensured by keying. For this purpose the keying pin CS-MSTB is inserted in the socket and the corresponding contact pin taken off with the keying clippers. Using a blind piece MSTB-BL individual contacts can be covered in order to achieve a compartment formation on the pin strip.

The electronic component housing UEGM-MSTB snaps on commercially available DIN EN mounting rails.

For technical data and printed circuit board dimensions refer to page 27.

Power loss dependent upon the ambient temperature see page 22.  
Same power loss is applicable as with electronic component housings UEGM 25.

	Solid, [mm <sup>2</sup> ]	fine strand, AWG	I [A]	VAC [V]
Connection data	2.5	2.5	14	12* 250*

\* Voltage and current values are affected by the configuration of the printed circuit board.

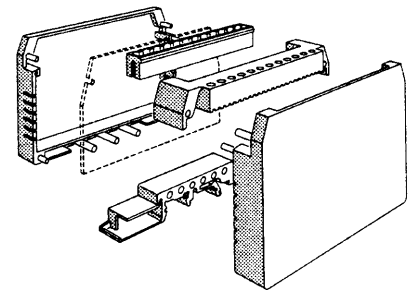

Description	No. of positions	Type	Order No.	Pcs. Pkt.
<b>Electronic component housing, with 12 position COMBICON pin strip, additionally fitted with 3 mm LED light indicator</b>	12	UEGM-MSTB	27 81 45 3	10
<b>COMBICON header, 5.08 mm grid for other COMBICON plug types see catalog page 302</b>	2	MSTB 1.5/2-ST-5.08	17 57 01 9	50
	3	MSTB 1.5/3-ST-5.08	17 57 02 2	50
	4	MSTB 1.5/4-ST-5.08	17 57 03 5	50
	5	MSTB 1.5/5-ST-5.08	17 57 04 8	50
	6	MSTB 1.5/6-ST-5.08	17 57 05 1	50
	7	MSTB 1.5/7-ST-5.08	17 57 06 4	50
	8	MSTB 1.5/8-ST-5.08	17 57 07 7	50
	9	MSTB 1.5/9-ST-5.08	17 57 08 0	50
	10	MSTB 1.5/10-ST-5.08	17 57 09 3	50
	12	MSTB 1.5/12-ST-5.08	17 57 11 6	50
(1) <b>Blind piece</b> , for coding and compartment formation, plugs onto pole pin, green plastic		MSTB-BL	17 55 47 7	100
(2) <b>Keying pin</b> , engages in the plug contact, remove counter pole in the housing, red plastic		CS-MSTB	17 59 99 4	100
(3) <b>Plugs</b> , for closing LED positions not in use		UEGM-MSTB-BS	27 81 46 6	60
(4) <b>Keying pliers</b> , for snipping contact pins, if the keying pin CS-MSTB is fitted in the plug		MSTB-ZA	17 67 60 1	1
(5) <b>Marking card</b> , with 25 pcs. 10 section white marking strips, self adhesive, sufficient for 250 terminals		a) SKS 5: unprinted	14 01 20 0	10
		b) SKS 5: 1-10	14 01 21 3	
		c) SKS 5: 11-20 etc. up to SKS 5: 191-200		
		c) SKS 5: L1-N, PE	14 02 27 0	
		c) SKS 5: U-N	14 01 28 4	
(6) <b>Marker pen</b> , for individual labelling of unprinted SKS 5		B-Pen	10 51 99 3	1

**Note:**  
COMBICON plug connectors may only be actuated when not under power. If for technical operating reasons smaller loads are to be switched, experience values are available upon request.

mm	to inch
3.6	= (.142)
10	= (.394)
18	= (.709)
25	= (.984)
79	= (3.110)
90.5	= (3.563)
95.5	= (3.760)
98	= (3.858)



# Electronic Component Housings for European Format Cards UEG-EU

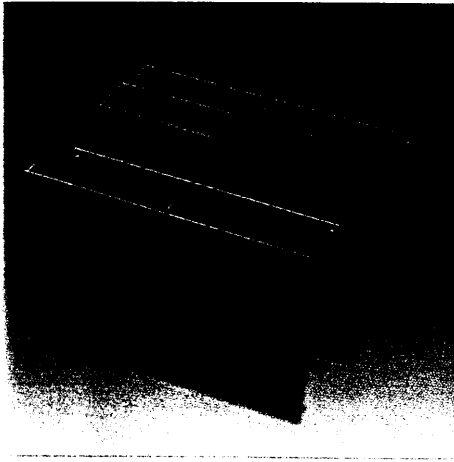

The rail mountable component housing UEG-EU has been specially designed to receive European format cards. The printed circuit board is directly fixed in the housing middle section and the housing closed with two side elements. The positions of the fixing holes on the printed circuit board are the same as for fixing high position plug connectors onto the printed circuit board – so see DIN 41612/part 1. In the middle section break-outs can be punched for the connection elements, whereby both high position plug connectors as well as electronic printed circuit terminal blocks can be used.

For technical data and printed circuit board dimensions see page 27.

## Type of moldings

Material = Polyamide 6, see catalog page 12  
Color: green

Marking and mounting material see catalog page 10

Maximum component height on the printed circuit board with 1 basic element

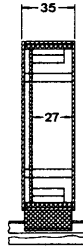

## UEG-EU Component housing for European format cards

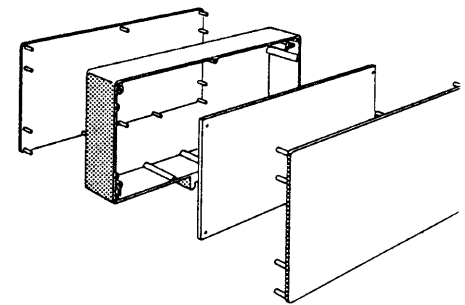
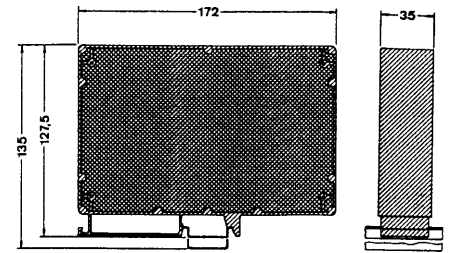

## Description

**Electronic component housing**, comprising:  
basic element with snap foot, for fitting on rail, 32 mm (1.260) wide.

**Side element**, two pieces, for covering the basic element on both sides,  
1.5 mm (.059) thick

**Connection pin**, for engaging several basic elements to form one unit;  
12 necessary per element, brass

Type	Order No.	Pcs. Pkt.
UEG-EU-BE	29 56 81 9	5
UEG-EU-SE	29 56 82 2	5
UEG-EU-VS	50 28 88 3	100

mm to inch  
27 = (1.063)  
35 = (1.378)  
127.5 = (5.020)  
135 = (5.315)  
172 = (6.772)

# Printed Circuit Board Layouts for the Electronic Component Housings UEG, UEGM, UEGM-MSTB, UEG-EU in a 1:1 Scale

Component Housing UEG  
Printed Circuit Board for Component Housings with Screw Connection

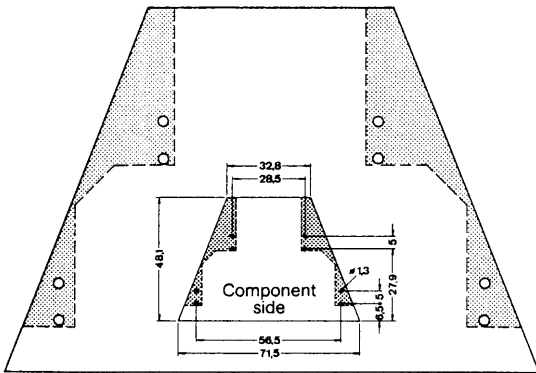

Component Housing UEGM  
Printed Circuit Board for Component Housings with Screw Connection

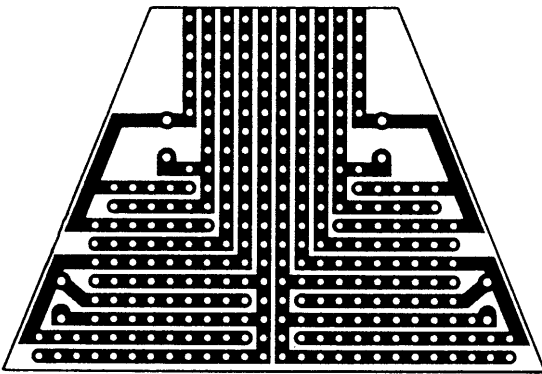
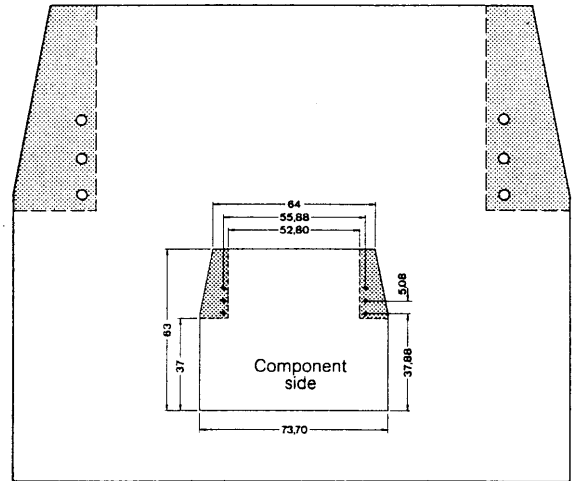

Printed Circuit Board P1-UEG

Printed Circuit Board for Component Housings with Tab Connection

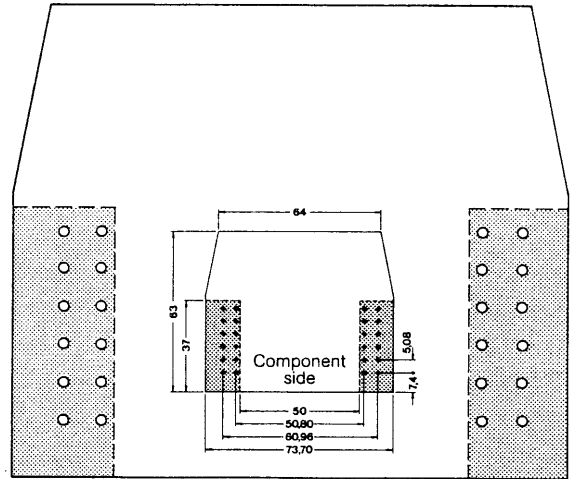

Printed Circuit Board for Component Housings with Tab Connection

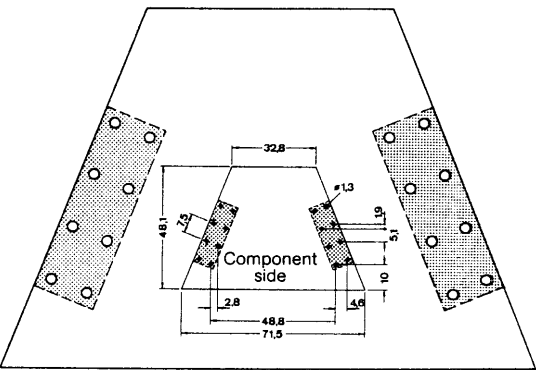

Printed Circuit Board P1-UEGM for Screw and Tab Connection

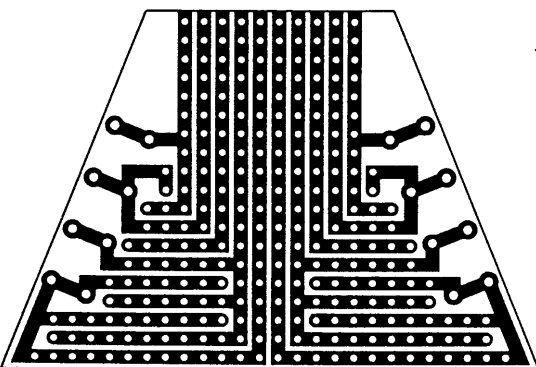
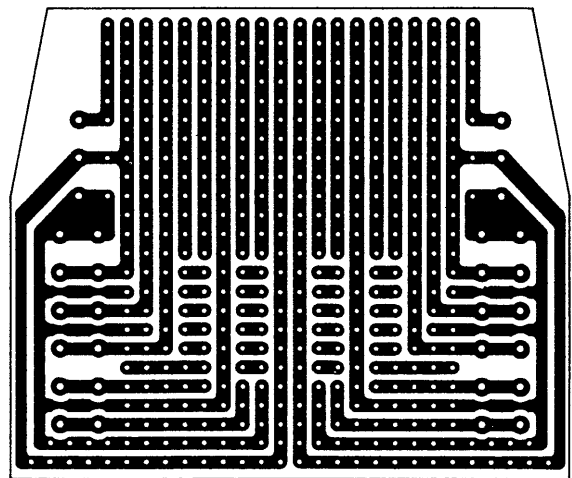

Printed Circuit Board P1-UEG-FS/FS

### Technical data for the printed circuit board

- Basic material: epoxy glass filament fabric  
1.5 mm ( .059) thick as per DIN 40802
- Copper plating: 70 µm
- Conductor path width: 2 mm ( .0790)
- Air and creepage distance: 125 V AC as per VDE 0110/Gr. C  
VDE 0160
- Holes: 1.3 mm ( .051) dia. for the solder pins of  
the screw and tab connections  
0.9 mm ( .035) dia. for the components as per DIN 40801 page 2

## Component Housing UEGM-MSTB

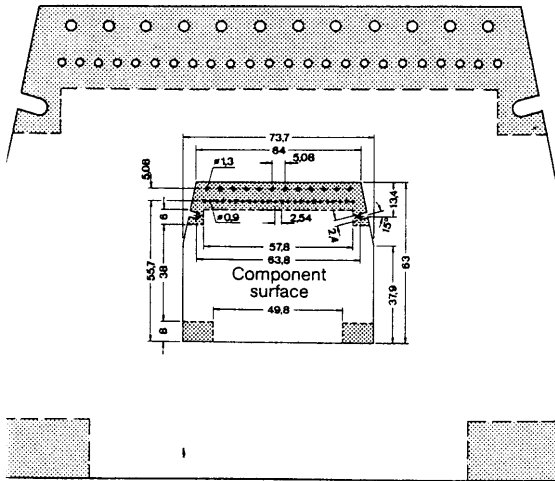

### Technical data for the printed circuit board

Basic material: epoxy glass filament fabric  
 1.5 mm (.059) thick as per DIN 40802  
 Copper plating: 70 μm  
 Holes: 1.3 mm (.051) dia. for the solder pins of the COMBICON header  
 0.9 mm dia. for the components as per DIN 40801 page 2

### mm to inch

0.9	= (.035)	37	= (1.457)
1.3	= (.051)	37.88	= (1.491)
1.9	= (.075)	37.9	= (1.492)
2.4	= (.094)	38	= (1.496)
2.54	= (.100)	48.1	= (1.894)
2.76	= (.109)	48.8	= (1.912)
2.8	= (.110)	49.8	= (1.961)
4.6	= (.181)	50	= (1.968)
5	= (.197)	50.8	= (2.000)
5.05	= (.199)	52.8	= (2.079)
5.08	= (.200)	55.7	= (2.193)
5.1	= (.201)	55.88	= (2.200)
6	= (.236)	56.5	= (2.224)
6.5	= (.256)	57.8	= (2.275)
7.4	= (.291)	60.96	= (2.400)
7.5	= (.295)	63	= (2.480)
8	= (.315)	63.8	= (2.512)
10	= (.394)	64	= (2.520)
13.4	= (.527)	71.5	= (2.815)
27.9	= (1.098)	73.7	= (2.901)
28.5	= (1.122)	100	= (3.937)
32.8	= (1.291)	160	= (6.299)

## Component Housing UEG-EU

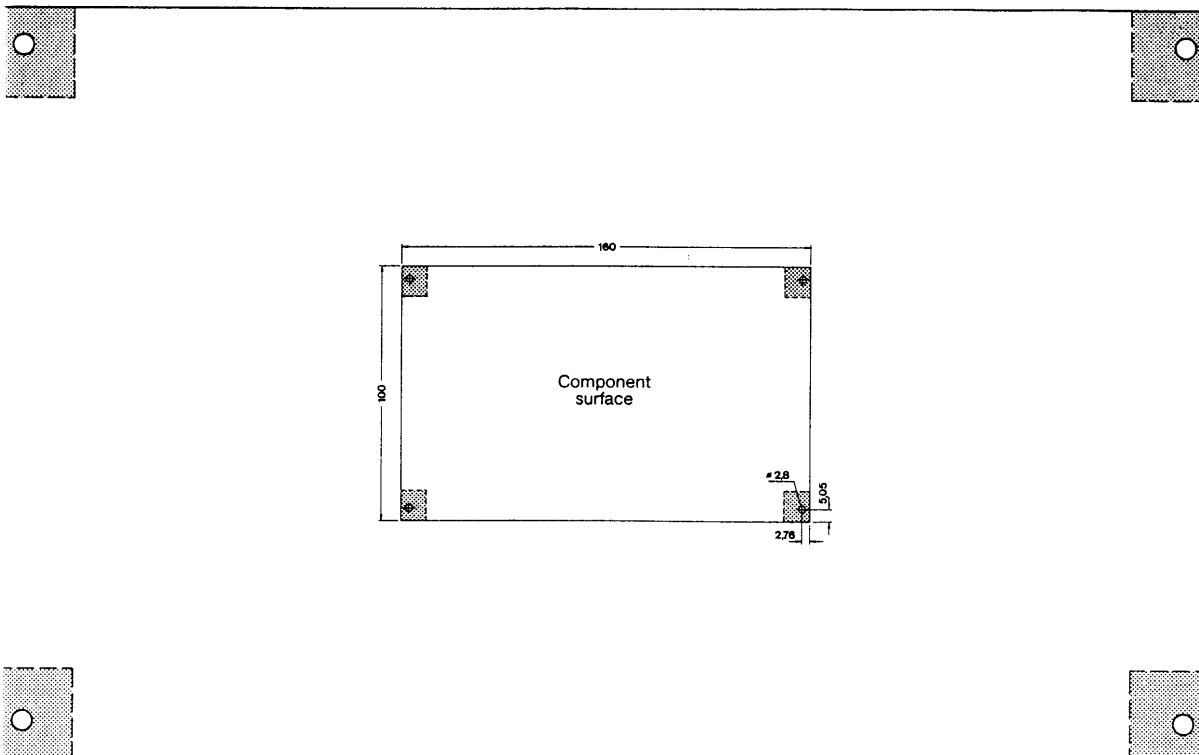

### Technical data for the printed circuit board

Basic material: epoxy glass filament fabric  
 1.5 mm (.059) thick as per DIN 40802  
 Copper plating: 70 μm  
 Holes: 1.3 mm (.051) dia. for the solder pins of the screw and tab connections.  
 0.9 mm (.035) dia. for the components as per DIN 40801 page 2

# Compact Custom Circuit Modules UMK

UMK



### Type of moldings

**Material** = Polyamide 6.6, see catalog page 12  
**Color:** green

Marking and mounting material see catalog page 10

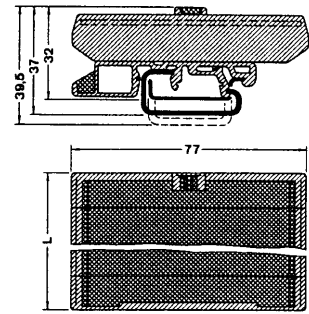

**mm to inch**  
 32 = (1.260)  
 37 = (1.457)  
 39.5 = (1.555)  
 77 = (3.031)

The compact custom circuit module UMK is used where simple adaption and interconnection functions as well as comprehensive electronic circuits require individual rail mountable installation. They are comprised of various single elements with varying dimensions and functions. Depending upon the desired module size and the required space requirement, the various individual elements are linked together to form a module. The PC board base modules UMK are available in a 22.5 – 33.75 – 45 etc. mm.

Two side elements each 11.25 mm wide produce – when engaged – the smallest module of 22.5x77 mm. Due to the availability of the various base elements of 22.5 – 22.5 or 45 mm width the individually required module dimensions are created. Depending upon the module size one or several foot elements are to be provided.

### Advantages:

Fast assembly due to the plug in modular principle. The tight engagement of the individual elements ensures a high connection strength.

Due to the universal foot the module snaps on commercially available DIN EN mounting rails.

The modules can either be marked using the labeling grooves in the side elements or using the Phoenix module marking 'MB', which snaps in a hole (4 mm dia.) in the printed circuit board.

Wide range of connection possibilities for the external conductor connections due to the large selection of electronic printed circuit boards, the screw, tab connections, the COMBICON plug connector etc. (see catalog page 290).

### Description



**Universal module**, comprising of:  
**Side element** 11.25 mm (.443) wide, with label groove

**Side element**, 11.25 mm (.443) wide, without label groove

**Base element**, 11.25 mm (.443) wide

**Base element**, 22.5 mm (.886) wide

**Base element**, 45 mm (1.772) wide

**Foot element**, for mounting on  or , slideable between base and side elements

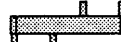

### Type

UMK-SE 11.25

UMK-SE 11.25-1

UMK-BE 11.25

UMK-BE 22.5

UMK-BE 45

UMK-FE

### Order No.

29 70 00 2

29 70 44 2

29 71 53 5

29 70 02 8

29 70 01 5

29 70 03 1

### Pcs. Pkt.

10

10

10

10

10

10

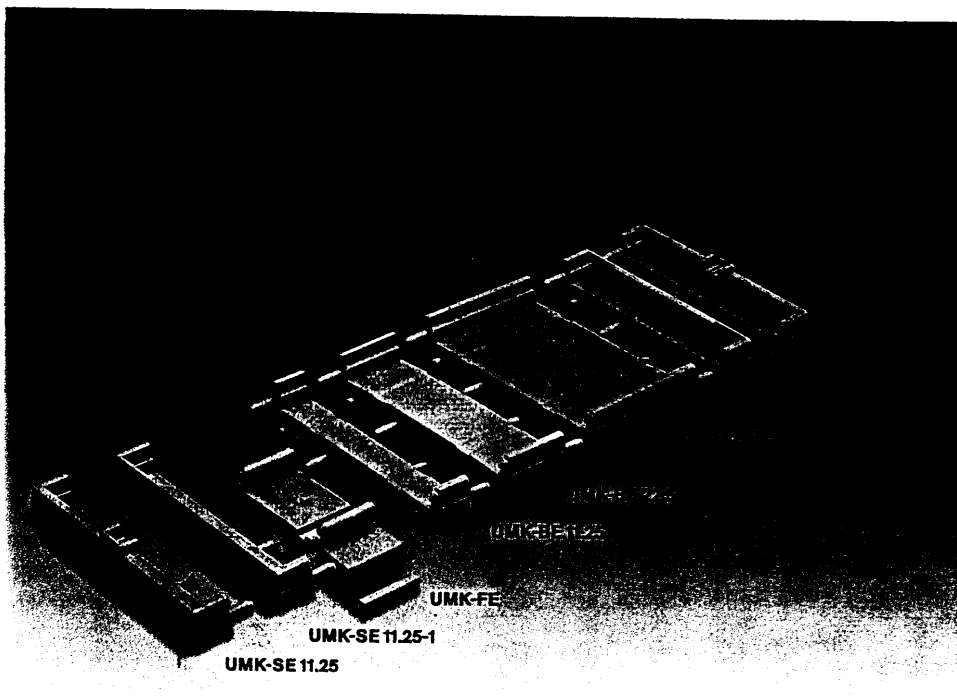

Assembly drawing of the universal module UMK

PCB dimensions (mm)	Module length L (mm)	Side element UMK-SE...	Base element UMK-BE 11.25	Base element UMK-BE 22.5	Base element UMK-BE 45	Foot element UMK-FE
20.00 x 72 x 1.5	22.50	2	-	-	-	1
31.25 x 72 x 1.5	33.75	2	1	-	-	1
42.50 x 72 x 1.5	45.00	2	-	1	-	2
53.75 x 72 x 1.5	56.25	2	1	1	-	2
65.00 x 72 x 1.5	67.50	2	-	-	1	2
76.25 x 72 x 1.5	78.75	2	1	-	1	2
87.50 x 72 x 1.5	90.00	2	-	1	1	2
98.75 x 72 x 1.5	101.25	2	1	1	1	2
110.00 x 72 x 1.5	112.50	2	-	-	2	2
121.25 x 72 x 1.5	123.75	2	1	-	2	2
132.50 x 72 x 1.5	135.00	2	-	1	2	2
143.75 x 72 x 1.5	146.25	2	1	1	2	3
155.00 x 72 x 1.5	157.50	2	-	-	3	3
166.25 x 72 x 1.5	168.75	2	1	-	3	3
177.50 x 72 x 1.5	180.00	2	-	1	3	3

Order example:

UMK module, length 90 mm (3.543), for printed circuit boards 87.5 x 72 x 1.5 (3.445 x 2.835 x .059) comprising

- 9 70 00 2 2 side elements UMK-SE 11.25
- 9 70 02 8 1 base element UMK-BE 22.5
- 9 70 01 5 1 base element UMK-BE 45
- 9 70 03 1 2 foot elements UMK-FE

For printed circuit boards see catalog page 290.

# Universal Module UM for Custom Circuits

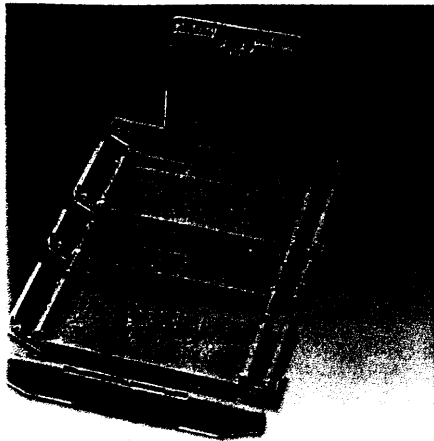

The universal module UM is suitable to accommodate one printed circuit board for mounting individual electronic circuits, e.g. programmable controls. They comprise individual elements with various dimensions and functions. By arranging individual base elements in a row the printed circuit board face can be multiplied. Metal pins engage the individual base elements to form a sturdy unit. The various base elements are available with and without ribs to support the printed circuit board. Do not locate solder points or component fixings in the area of these ribs. Dependent upon the module size one or more base elements are fitted with a snap foot, which easily engage on DIN-EN mounting rails. The side elements form both base element ends arranged in a row and are available in three executions.

the low side element UM-SE,  
the tall side element UM-SE-A 60 for  
60 mm wide U profile covers and  
the tall side element UM-SE-A 73 for  
73 mm wide U profile covers.

The tall side elements are available with and without guide grooves for mechanical mounting of the printed circuit board vertically on the base PCB.

The transparent U profile covers are available in various lengths, which depend on the number of base elements used. They are screw fitted for the tall side elements. Furthermore an engageable transparent hood is available for a base element with a snap foot for the lower side elements.

An adaptor rail is available for inserting European format cards. It is pushed laterally over the edge of the base elements thus reducing the width to the European format card dimension. Furthermore, various modules are available for fitting European format cards.

A comprehensive range of electronic printed circuit terminal blocks is available for the conductor connection (see catalog page 290).

## UMI

with ribs for mechanical PCB support

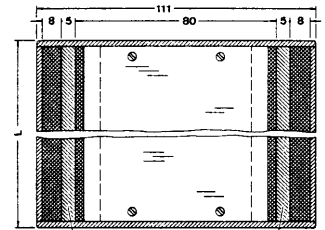
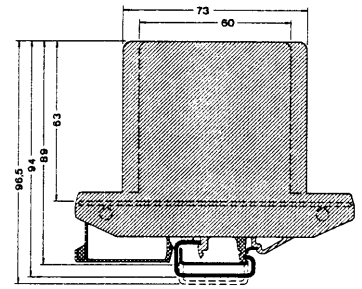

### Type of moldings

**krilen** = Polyamide 6.6, see catalog page 12  
Color: green

### U profile cover

Unbreakable PVC  
max. temperature: 70° C

### Transparent cover

Unbreakable polycarbonate,  
Difficult to ignite and self extinguishing,  
max. hood temperature: 100° C

Marking and mounting material see catalog page 10

### mm to inch

5	= (.197)
8	= (.315)
60	= (2.362)
63	= (2.480)
73	= (2.874)
80	= (3.150)
89	= (3.503)
94	= (3.701)
96.5	= (3.800)
106	= (4.173)
111	= (4.370)

### Description

**Universal module**, individual assembly, selectable consisting of:

**Base element** with snap foot, for mounting on or

a) with ribs, L=35 mm (1.378)

b) without ribs, L=35 mm (1.378)

**Base element**, without snap foot, necessary for connection of several base elements

a) with ribs, L=35 mm (1.378)

b) without ribs, L=35 mm (1.378)

**Base element**, without snap foot, necessary for connection of several base elements

a) with ribs, L=16.5 mm (.650)

b) without ribs, L=16.5 mm (.650)

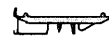

a) **UM-BEFE 35**

**29 55 56 4**

10



a) **UM-BE 35**

**29 55 57 7**

10



a) **UM-BE 16.5**

**29 56 90 3**

10

**Connection pin**, brass, for joining several base elements into one unit, 4 pieces per element

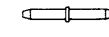

**UM-VS**

**29 55 58 0**

50

**Side element**, low version, for connection on both ends of the base elements UM-BEFE.



**UM-SE**

**29 55 59 3**

10

**Side element**, tall version, for double sided connection of the base elements UM-BEFE



**UM-SE-A 60**

**29 55 61 6**

10

for 60 mm wide U profile cover



**UM-SE-A 73**

**29 55 60 3**

10

**Side element**, as above, however, with guide grooves for vertically arranged printed circuit boards



**UM-SE-A 60-R**

**29 56 89 3**

10

**UM-SE-A 73-R**

**29 56 74 1**

10

### U profile cover, transparent,

a) **60 mm (2.362) wide**, screw fitting on side element UM-SE-A 60

for 1 base element UM-BE...35

2 base elements UM-BE...35

3 base elements UM-BE...35

4 base elements UM-BE...35 and

1 base element UM-BE 16.5 for

European format card 100x160x1.5 mm

b) **73 mm (2.874) wide**, screw fitting on

side element UM-SE-A 73

for 1 base element UM-BE...35

2 base elements UM-BE...35

3 base elements UM-BE...35

4 base elements UM-BE...35 and

1 base element UM-BE 16.5 for

European format card 100x160x1.5 mm

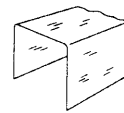

**UM-A/U 60-35**

**29 55 65 8**

1

**UM-A/U 60-70**

**29 55 66 1**

1

**UM-A/U 60-105**

**29 55 67 4**

1

**UM-A/U 60-156.5**

**29 55 55 1**

1

**UM-A/U 73-35**

**29 55 62 9**

1

**UM-A/U 73-70**

**29 55 63 2**

1

**UM-A/U 73-105**

**29 55 64 5**

1

**UM-A/U 73-156.5**

**29 56 16 5**

1

**Transparent cover**, transparent for one base element, UM-BEFE (with 2 UM-SE) engageable, 60 mm wide, 50 mm high

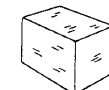

**UM-H**

**29 55 44 1**

1

**Adaptor**, necessary for European format cards, pushed laterally over the edge of the base elements, reduces width to 100 mm, marking with labeling strip SKS, see catalog page 290, plastic, 156.5 mm (6.555) long



**UM-AE**

**29 56 48 2**

1

**Universal module**, complete accepting a European format card 100x160 mm, without U profile cover

**UM-LG 160**

**29 56 94 5**

1

**Universal module**, as above, however with an additional 60 mm (2.362) wide U profile cover

**UM-LG 160/A 60**

**29 56 95 8**

1

**Universal module**, as above, however with an additional 73 mm (2.874) wide U profile cover

**UM-LG 160/A 73**

**29 56 97 4**

1

**UMI**  
without ribs

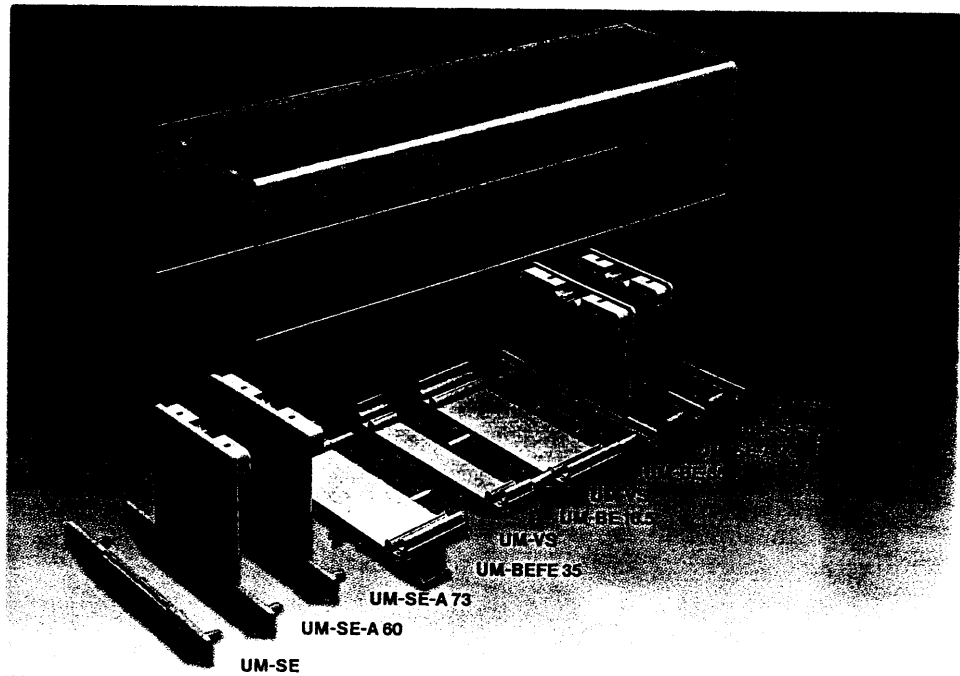
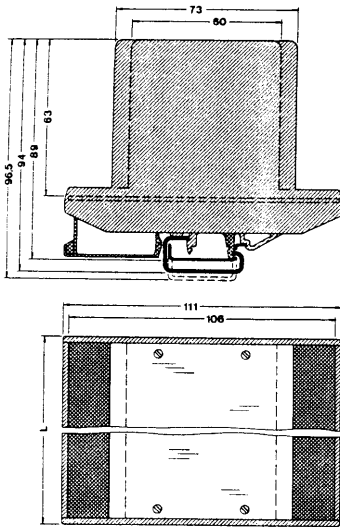

Assembly drawing of UM module base elements with ribs

type	Order No.	Pcs. Pkt.
) UM-BEFE 35-1	29 56 66 0	10
) UM-BE 35-1	29 56 65 7	10
) UM-BE 16.5-1	29 58 05 3	10
UM-VS	29 55 58 0	50
UM-SE-1	29 58 14 7	10
UM-SE-A 60	29 55 61 6	10
UM-SE-A 73	29 55 60 3	10
UM-SE-A 60-R	29 56 89 3	10
UM-SE-A 73-R	29 56 74 1	10
UM-A/U 60-35	29 55 65 8	1
UM-A/U 60-70	29 55 66 1	1
UM-A/U 60-105	29 55 67 4	1

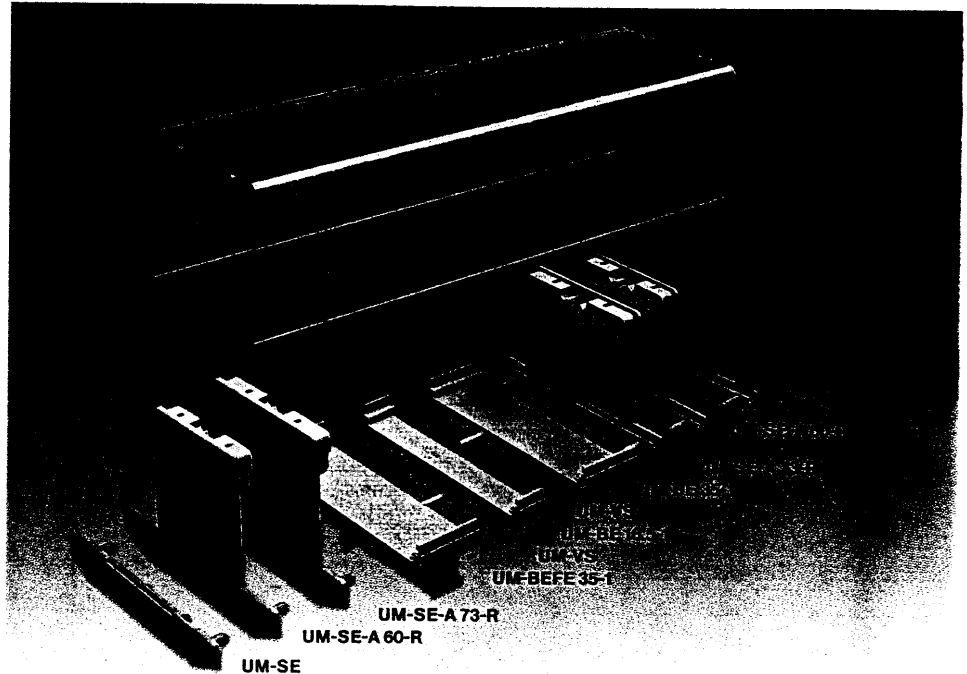

Assembly drawing of UM module base elements without ribs

Dimensions of the PCB* [mm]	Module length L [mm]	Base element UM-BEFE 35		Base element UM-BE 35		Base element UM-BE 16.5		Base element UM-SE		Length [mm] of the U profile cover UM-A/U 60... UM-A/U 73...
		UM-BEFE 35-1	UM-BEFE 35-1	UM-BE 35-1	UM-BE 35-1	UM-BE 16.5-1	UM-BE 16.5-1	UM-SE	UM-SE A 60	
38.5x107.5x1.5	40	1	-	-	-	-	-	2	-	35
55.0x107.5x1.5	56.5	1	-	-	1	-	-	2	-	51.5
73.5x107.5x1.5	75	2	-	-	-	-	-	2	-	70
90.0x107.5x1.5	91.5	2	-	-	-	1	-	2	-	86.5
108.5x107.5x1.5	110	2	1	-	-	-	-	2	-	105
125.0x107.5x1.5	126.5	2	1	1	1	-	-	2	-	121.5
143.5x107.5x1.5	145	2	2	2	-	-	-	2	-	140
160.0x107.5x1.5	161.5	2	2	2	1	-	-	2	-	156.5
178.5x107.5x1.5	180	3	2	2	-	-	-	2	-	175

\* When using the adaptor UM-AE the printed circuit board is reduced to 100 mm (3.937).

**Order examples:**

**UM-module, length 40 mm (1.575), for printed circuit board 38.5 x 107.5 x 1.5 (1.516 x 4.232 x .059)**  
comprising  
29 55 56 4 1 base element UM-BEFE  
29 55 59 3 2 side elements UM-SE  
29 55 44 1 1 cover UM

**UM module, length 110 mm (4.331), for printed circuit board 108.5 x 107.5 x 1.5 (4.272 x 4.232 x .059)**  
comprising  
29 55 56 4 2 base elements with snap foot UM-BEFE  
29 55 57 7 1 base element without snap foot UM-BE  
29 55 58 0 8 connection pins UM-VS  
29 55 60 3 2 side elements UM-SE-A 73  
29 55 64 5 1 U profile cover UM-A/U 73-105

**UM module 160 mm (6.299), for printed circuit boards in European format 100 x 160 x 1.5 (3.937 x 6.299 x .059)**  
comprising  
29 55 56 4 2 base elements with snap foot UM-BEFE 35  
29 55 57 7 2 base elements without snap foot UM-BE 35  
29 56 90 3 1 base element without snap foot UM-BE 16.5  
29 55 58 0 12 connection pins UM-VS  
29 55 61 6 2 side elements UM-SE A 60  
29 55 55 1 1 U profile cover UM-A/U 60-156.5  
29 56 48 2 1 adaptor UM-AE

**Information:**  
For PCB terminals see catalog page 290.

# Mounting Plate EM-MP for Switching Equipment

**EM-MP**  
45 mm wide

**EM-MPG 45**  
45 mm wide

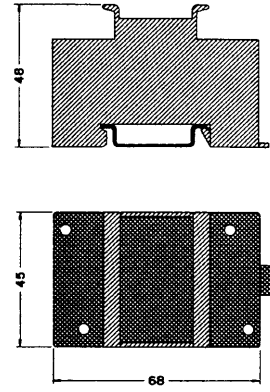
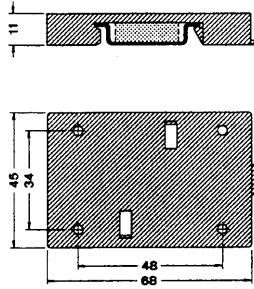
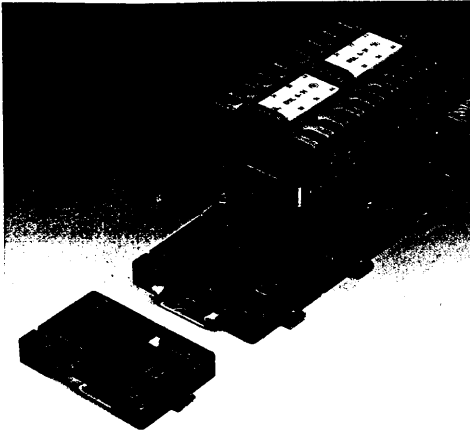

Description	Type	Order No.	Pcs. Pkt.	Type	Order No.	Pcs. Pkt.
<b>Mounting plate,</b> for screw fitting size 0 switching equipment	<b>EM-MP 45</b>	<b>29 44 15 1</b>	<b>5</b>			
<b>Mounting plate,</b> enclosed design, to snap on size 0 switching equipment				<b>EM-MPG 45</b>	<b>29 44 17 7</b>	<b>5</b>
<b>Cover,</b> for the mounting plate EM-MP 45 for fitting protection elements	<b>EM-MP 45 H</b>	<b>29 44 16 4</b>	<b>5</b>			

These rail mounting plates have been specially conceived for size 0 switching equipment. They can accommodate Protection elements or coil protection circuits and motor interference suppression elements. Simple interface functions as linking element between electronic controls and conventional contactor controls can be realized in these units. The following two versions are available:

- Mounting plate EM-MP 45 for screwing onto size 0 switching equipment. The cover, which snaps below the mounting plate, accommodates protection elements for coil protection circuits. The connection lines of the protection elements for the coil connections can be led out of the mounting plate fronts.
- The enclosed mounting plate EM-MPG 45 offering housing character permit size 0 switching equipment to be snapped on. In the mounting plate interior interface functions and protection circuits for coil and motor interference suppression can be fitted. The connection lines between electronic circuit and switching equipment can be led out of the mounting plate front.

Both mounting plates snap on the  symmetrical mounting rail in accordance with DIN 50 022.

mm to inch  
11=(.433)  
34=(1.338)  
45=(1.772)  
48=(1.890)  
68=(2.677)