

Weil viele unterschiedliche elektronische und elektrische Geräte und Anlagen gleichzeitig betrieben werden, sind hohe Anforderungen an ihre Elektromagnetische Verträglichkeit (EMV) zu stellen. Seit 1.1.1996 gelten mit der EG-Richtlinie verbindliche EMV-Schutzziele.

Siemens Matsushita Components hilft, sie einzuhalten und hat dafür ein umfangreiches Programm innovativer, nutzenoptimierter EMV-Komponenten entwickelt. Darunter sind auch viele standardisierte Bauelemente, die mit ihren Fertigungs-, Kosten- und Liefervorteilen ein breites Anwendungsspektrum optimal abdecken.

SMD-Induktivitäten für anspruchsvolle Anwendungen

Langjährige Erfahrung und eine strikte Kundenorientierung kommen unserem SMD-Drosselprogramm zugute.

HF-SMD-Drosseln mit erstklassigen elektrischen Eigenschaften sind jetzt in den Baugrößen 0603 bis 2220 verfügbar. Sie gewährleisten eine hohe Packungsdichte und leisten damit einen wertvollen Beitrag zur Miniaturisierung, u. a. in der Telekommunikation, Automobilelektronik, MSR-Technik und in Industrieanwendungen.

S + M Components bietet nicht nur das breiteste Spektrum an SMD-Induktivitäten, sondern ist aufgrund der herausragenden Zuverlässigkeit dieser Bauelemente die Nummer 1 im Markt der europäischen Kfz-Elektronik-Hersteller.

Datenleitungsdrosseln werden in der Telekommunikation, Automobilelektronik sowie der Gebäude- und Automatisierungstechnik eingesetzt.

In der Kfz-Elektronik setzen sich CAN-Bussysteme immer mehr durch. S + M Components liefert zur Beschaltung der Schnittstellen SMD-Datenleitungsdrosseln und ist auf diesem Gebiet weltweit die Nummer 1.

In der Telekommunikation werden SMD-Datenleitungsdrosseln mit großem Erfolg in ISDN-Systemen eingesetzt.

Alle Entstörungsvorteile im Netz

Wenn leitungsgebundene Störungen zu verhindern sind oder Störfestigkeit erzielt werden muß, hat S + M Components die richtigen Produkte für Ihre Anwendungen.

X-/Y-Kondensatoren werden kontinuierlich weiterentwickelt. Speziell durch Innovationen bei den Folienkondensatoren werden diese Bauelemente immer kleiner und preisgünstiger – natürlich ohne Kompromisse bei der Qualität und den Eigenschaften.

D-Kern-Drosseln unterdrücken wirkungsvoll leitungsgebundene Störungen in Schaltnetzteilen, beispielsweise von EVGS und TV-Geräten. Sie zeichnen sich durch geringen Platzbedarf, gute HF-Eigenschaften und ein kleines Streufeld aus.

Mit neuester Technologie werden sie ohne Verguß und Klebematerialien hergestellt, wodurch sie sehr umweltfreundlich und gut recycelbar sind. Der hohe Automatisierungsgrad ermöglicht darüber hinaus exakt reproduzierbare elektrische und mechanische Eigenschaften sowie niedrige Herstellungskosten.

Filter zur Entstörung von Geräten und Systemen werden als Standardfilter und in kundenspezifischen Varianten angeboten.

Unsere SIFI-Filter z. B. sind standardisierte Baureihen in kostengünstig aufgebauter Leiterplattentechnik. Sie sind in verschiedenen Dämpfungs- und Stromabstufungen sowie unterschiedlichen Gehäuseformen erhältlich, so daß in praktisch jedem Fall die genau passende Lösung schnell zur Verfügung steht.

Umrichterfilter werden bei Stromversorgungen, USV-Anlagen und medizinischen Einrichtungen mit IGBT-Leistungshalbleitern eingesetzt.

Hier ist ein völlig neues Marktsegment entstanden, das S + M Components dank seines breiten, innovativen Produktspektrums entscheidend mitgeprägt hat. Damit gehört das Unternehmen auf diesem Gebiet zu den führenden Herstellern in Europa.

Das Angebot reicht schon bei Standardausführungen von 8 bis 1600 A in 2-, 3- oder 4-Leiter-Technik. Diese Filter sind unter Vollastbedingungen optimiert und 1- oder 2-stufig lieferbar. Filter für Industrienetze mit 690 Vac sind die neueste Entwicklung.

Filter für Anlagen und geschirmte Räume

Geschirmte Räume schützen einerseits gegen elektromagnetische Felder, müssen andererseits jedoch auch mit Energie versorgt werden und kommunikationsfähig bleiben. S + M Components stellt anspruchsvolle, kostengünstige Filterlösungen her, die dieser Aufgabe voll gerecht werden.

Komplett-Angebot von EMV-Systemlösungen zu umfassenden Dienst- und Betreuungsleistungen

Über Standardbauelemente und kundenspezifische Lösungen hinaus bietet S + M Components geschirmte Kabinen von 1 kHz bis 40 GHz, Schirmungsbauteile, wie Türen und Fenster sowie vollständig ausgestattete Absorberhallen an. Ergänzt wird dieses Angebot durch das EMV-Labor in Regensburg, das mit hochqualifizierten Dienstleistungen der ideale Partner bei allen EMV-Problemen und Aufgaben ist.

Das eigene Dienstleistungsangebot wird abgerundet durch eine europaweite Zusammenarbeit mit anderen führenden EMV-Labors. Dadurch kann allen Kunden eine flächendeckende Design-in-Unterstützung auf höchstem Niveau angeboten werden.

Weitere Informationen über unsere Produkte erhalten Sie im Internet unter <http://www.siemens.de/pr/index.htm>. Wenn Sie gleich einen unserer Beratungsfachleute sprechen wollen, wenden Sie sich an die Siemens-Niederlassung in Ihrer Nähe.

Designing the Future

The simultaneous operation of many different items of electrical and electronic equipment makes high demands on their electromagnetic compatibility (EMC). The EU Directive on EMC has made it mandatory to implement relevant protection measures as of January 1st 1996.

In order to satisfy these requirements, Siemens Matsushita Components has developed an extensive program of innovative EMC components designed specifically for this purpose. They include many standardized components optimized for a broad range of applications and offering particular benefits in terms of production, cost and delivery conditions.

SMD inductors for demanding applications

Many years of experience coupled with strict orientation to customer needs have led to the production of an outstanding range of SMD chokes.

RF SMD chokes with first-class electrical properties are now available in sizes 0603 to 2220. They guarantee a high packing density and thus make a significant contribution to miniaturization in applications as diverse as telecommunications, automotive electronics, process control technology and industrial electronics.

Siemens Matsushita Components not only offers the widest range of SMD inductors, their outstanding reliability have also made it the market leader among European manufacturers of automotive electronics.

Data line chokes are used in telecommunications, automotive electronics as well as structural and automation technology.

CAN bus systems are becoming increasingly popular in automotive electronics. Siemens Matsushita Components supplies SMD data line chokes for interfaces and is world-wide leader in this sector.

In the field of telecommunications, SMD data line chokes are used with great success in ISDN systems.

Interference suppression benefits all along the line

Whenever conducted interference must be prevented or interference immunity must be achieved, Siemens Matsushita Components has just the right products for your applications.

X/Y capacitors are being continuously developed. Thanks particularly to innovations in film capacitors, these components are becoming increasingly compact and inexpensive – naturally without compromising their quality or properties in any way.

D core chokes effectively suppress conducted interference in switched-mode power supplies, such as in electronic ballast systems and TV sets. They are distinguished by their low space requirement, good RF properties and small leakage fields.

State-of-the-art technology means that they are manufactured without encapsulation or the use of adhesive materials. This makes them extremely environmentally friendly and easy to recycle. The high degree of automation also permits exactly reproducible electrical and mechanical properties as well as low manufacturing costs to be achieved.

Filters for interference suppression in equipment and systems are offered both as standard components and in customer-specific variants.

Our SIFI filters, for example, are standardized components of cost-effective design in circuit board technology. They are available in various attenuation and current stages as well as different package designs so that the most suitable solution for practically every application is available in next to no time.

Converter filters are used in power supply units, UPS installations and medical equipment using IGBT power semiconductors.

Siemens Matsushita Components has contributed greatly to shaping this completely new market segment thanks to a broad range of innovative products. This places the company up front among the leading manufacturers in Europe in this sector.

The range of standard versions alone extends from 8 to 1600 A in 2, 3 or 4-line technology. These filters are optimized under full load conditions and can be supplied in one or two-stage versions. The most recently developed components are filters for industrial networks operating at 690 Vac.

Filters for EMC installations and shielded rooms

Although shielded rooms are designed to provide protection against electromagnetic fields, they must also be supplied with energy and allow two-way communications. Siemens Matsushita Components manufactures sophisticated and attractively priced filter solutions that fully satisfy these requirements.

A complete range of EMC system solutions for a comprehensive range of service and support functions

In addition to standard components and customized solutions, Siemens Matsushita Components also offers shielded enclosures from 1 kHz to 40 GHz, shielding parts such as doors and windows as well as fully-equipped anechoic chambers.









This offer is supplemented by the EMC laboratory in Regensburg, whose highly-qualified services make it the ideal partner for all EMC problems and assignments.

Siemens Matsushita Component's own range of services is rounded off by its cooperation with other leading EMC laboratories all over Europe. This means that all our customers can obtain top-level support for the full range of their design project.

Further information about our products can be obtained on the Internet under <http://www.siemens.de/pr/index.htm>. If you would like to talk to one of our specialist consultants, simply contact your local Siemens company or sales office.

Inhalt

Contents

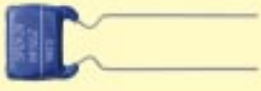
Bauformenverzeichnis Index of types	4		
Übersicht Selector guide	5		
HF-Drosseln RF chokes	6		
Drosseln für Signal- und Datenleitungen Chokes for signal and data lines	26		
Drosseln für Netzanwendungen Chokes for power lines	27		
Übersicht Selector guide	33		
Filter für allgemeine Anwendungen General-purpose filters	34		
Filter für Anlagen und Systeme Filters for installations and systems	37		
Filter für Umrichter und Leistungselektronik Filters for converters and power electronics	41		
Filter für Anlagen und geschirmte Räume Filters for installations and shielded rooms	44		
Durchführungsfiler Feed-through filters	48		
Durchführungskondensatoren Feed-through capacitors	49		
Entstörkondensatoren EMI suppression capacitors	50		
Entstörvaristoren EMI suppression varistors	54		
Gurtung und Verpackung Taping and packing	55		
EMV Labor EMC laboratory	58		
		Symbole und Begriffe Symbols and terms	60
		Anschriften Addresses	Umschlag-Rückseite Back cover

Bauformenverzeichnis

Index of Types

B78108-S	20	B82734	32
B78108-T	18	B82745	31
B78148-S	20	B82747	31
B78148-T	18	B82765	31
B81122	52	B82790	26
B81123	51	B82791	26
B81130	50	B84103	36
B81131	51	B84108	39
B81133	51	B84110-A	36
B81141	50	B84110-B	36
B81151	53	B84111	34
B81191	52	B84112	34, 35
B81551	53	B84113	35
B82111-B	25	B84114	35
B82111-E	24, 25	B84115	35
B82114	25	B84131	39
B82131	24	B84134-A, -B	40
B82132	24	B84134-F	40
B82133	24	B84142	41
B82134	24	B84143-A (440 V)	41
B82141	19	B84143-A (760 V)	43
B82143	21	B84143-B (440 V)	42
B82144	22	B84143-B (500 V, 760 V, 690 V IT)	43
B82145	23	B84144	42
B82412	11	B84261	47
B82422-A****-+100	12, 13	B84263	47
B82422-T	13, 14	B84299-C, -D	46
B82432	15	B84299-K2	37
B82442	16	B84299-K3	38
B82494	10	B84299-K5	38
B82496	7	B84299-K6	37
B82498-A	8	B84312	44, 45
B82498-B	9	B85111	49
B82499	6	B85121	49
B82500	24	B85122	49
B82502	27	B85313	48
B82503	28	B85321	48
B82504	27	B85331	48
B82505	27	B85332	48
B82506	27	SHCV-SR1, -SR2	54
B82507	28		
B82508	28		
B82510	28		
B82615	29		
B82617	29		
B82623	29		
B82624	29		
B82625	29		
B82627	29		
B82721	30		
B82722	30		
B82723	30		
B82724	30		
B82725	30		
B82731	32		
B82732	32		

SIMID®, SIFI® und SIOV® sind eingetragene Warenzeichen.
SIMID®, SIFI® and SIOV® are registered trademarks.

Drosseln Chokes

Übersicht Selector guide

Design (Baugröße/Size)	Nenninduktivität (µH) Rated inductance (µH)									Nennstrom (A) Rated current (A)					Nennspannung (V~) Rated voltage (Vac)	Anschlüsse Terminals					Mit Umhüllung Encapsulated	Bauform Type	Seite Page
	0,0010	0,010	0,10	1,0	10	100	1000	10000	100000	0,010	0,10	1,0	10	100		1000	SMD	Axial	Radial	RM / LS			
HF-Drosseln RF chokes																							
SIMID 09 (0402)																●					●	B82499	6
SIMID 06 (0603)																●					●	B82496	7
SIMID 08 (0805)																●					●/-	B82498	8/9
SIMID 04 (1008)																●					●	B82494	10
SIMID 01 (1210)																●						B82412	11
SIMID 02 (1210)																●					●	B82422	12-14
SIMID 03 (1812)																●					●	B82432	15
SIMID 05 (2220)																●					●	B82442	16
MCC																	●	●	●		●	B781*8-T	18
SBC																	●	●	●		●	B82141	19
BC																	●	●	●		●	B781*8-S	20
HBC																	●	●	●		●	B82143	21
LBC																	●		●		●	B82144	22
HLBC																	●		●		●	B82145	23
UKW															500		●		●		●	B8213*	24
															500		●		●/-		●	B82111	24
															250		●				●	B82500	24
															500		●		●		●/-	B82114	25
Drosseln für Signal- und Datenleitungen Chokes for signal and data lines																							
														42		●					●	B82790	26
														42					●		●	B82791	26
Drosseln für Netzanwendungen Chokes for power lines																							
Stabkern I core														500					●		●	B82502	27
														400					●			B82503	28
														500					●		●	B82504... B82506	27
														500 750					●			●	B82507... B82510
Pulver-Ringkern ¹⁾ Powder ring core ¹⁾													250					●		●	B82623... B82624	29	
													250					●	●	●	B82615... B82627	29	
Stromkomp. Ferrit-Ringkern Current-comp. Ferrit ring core													250					●		●	B82721... B82725	30	
													440						●	●	B82745... B82747	31	
													440						●	●	B82765	31	
D-Kern D core													250					●			B82731... B82734	32	

1) B82615...627 = Oberschwingungsdrosseln / B82615...627 = Harmonic chokes

HF-Drosseln RF Chokes



Baugröße 0402
Size 0402

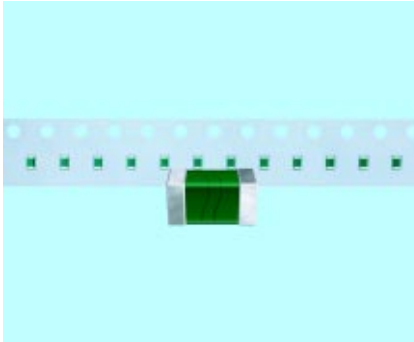

Baureihe SIMID 09

- Kernmaterial: Aluminiumoxid
- Gleiche Meßfrequenz für L und Q

Maße (mm)	$l \times b \times h$: 1,0 × 0,5 × 0,5
Anschlüsse	verzinkt
IEC-Klimakategorie	20/085/56
Lötbarkeit	IR-, Vapor-Phase-, Wellenlöten
Lieferform	8-mm-Blistergurt

SIMID 09 series

- Core material: Aluminum oxide
- Same meas. frequency for L and Q

Dimensions (mm)	$l \times b \times h$: 1,0 × 0,5 × 0,5
Terminals	tinned
IEC climatic category	20/085/56
Soldering	IR, vapor phase, wave soldering
Delivery mode	8-mm blister tape

L_N L_R nH	Toleranz Tolerance	Q_{min}	$f_L; f_Q$ MHz	I_N I_R mA	R_{max} Ω	$f_{res, min}$ MHz	Bestellnummer Ordering code
1,0	±0,3 nH ≐ A	8	100	400	0,05	6000	B82499-A3109-A
1,2		8	100	400	0,06	6000	B82499-A3129-A
1,5		8	100	400	0,07	6000	B82499-A3159-A
1,8		8	100	400	0,08	6000	B82499-A3189-A
2,2		8	100	400	0,09	6000	B82499-A3229-A
2,7		8	100	400	0,10	5500	B82499-A3279-A
3,3		7	100	400	0,12	5500	B82499-A3339-A
3,9		7	100	360	0,15	5200	B82499-A3399-A
4,7		7	100	360	0,17	4800	B82499-A3479-A
5,6		7	100	340	0,19	4600	B82499-A3569-A
6,8	±5% ≐ J	7	100	320	0,30	4000	B82499-A3689-J
8,2		7	100	320	0,35	3500	B82499-A3829-J
10		7	100	320	0,41	2800	B82499-A3100-J
12		7	100	320	0,45	2800	B82499-A3120-J
15		7	100	240	0,60	2500	B82499-A3150-J
18		7	100	240	0,70	2200	B82499-A3180-J
22		7	100	200	0,80	2000	B82499-A3220-J
27		7	100	200	1,20	1800	B82499-A3270-J
33		7	100	170	1,40	1800	B82499-A3330-J
39		7	100	150	1,70	1800	B82499-A3390-J

HF-Drosseln RF Chokes



Baugröße 0603
Size 0603

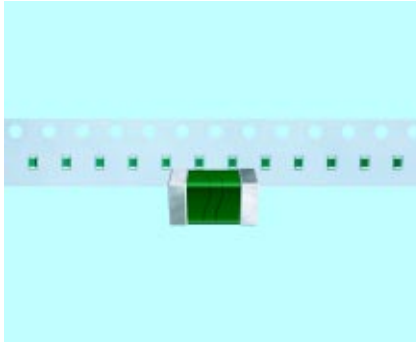

Baureihe SIMID 06

- Kernmaterial: Keramik
- Gleiche Meßfrequenz für L und Q

Maße (mm)	$l \times b \times h$ 1,6 × 0,8 × 0,8
Anschlüsse	verzinkt
IEC-Klimakategorie	40/085/56
Lötbarkeit	IR-, Vapor-Phase-, Wellenlöten
Lieferform	8-mm-Blistergurt

SIMID 06 series

- Core material: ceramics
- Same meas. frequency for L and Q

Dimensions (mm)	$l \times b \times h$ 1,6 × 0,8 × 0,8
Terminals	tinned
IEC climatic category	40/085/56
Soldering	IR, vapor phase, wave soldering
Delivery mode	8-mm blister tape

L_N L_R nH	Toleranz Tolerance	Q_{min}	$f_L; f_Q$ MHz	I_N I_R mA	R_{max} Ω	$f_{res, min}$ MHz	Bestellnummer Ordering code
1,5	$\pm 0,3$ nH $\hat{=} A$	8	100	500	0,07	6000	B82496-A3159-A
1,8		8	100	500	0,08	6000	B82496-A3189-A
2,2		8	100	500	0,09	6000	B82496-A3229-A
2,7		8	100	500	0,10	6000	B82496-A3279-A
3,3		9	100	500	0,12	5500	B82496-A3339-A
3,9	$\pm 5\%$ $\hat{=} J$	9	100	450	0,15	5500	B82496-A3399-J
4,7		9	100	450	0,17	4800	B82496-A3479-J
5,6		9	100	430	0,18	4600	B82496-A3569-J
6,8		9	100	430	0,20	3550	B82496-A3689-J
8,2		9	100	400	0,28	3500	B82496-A3829-J
10		10	100	400	0,32	2800	B82496-A3100-J
12		10	100	400	0,35	2800	B82496-A3120-J
15		10	100	350	0,41	2500	B82496-A3150-J
18		10	100	350	0,45	2300	B82496-A3180-J
22		10	100	300	0,50	2000	B82496-A3220-J
27		10	100	300	0,55	2000	B82496-A3270-J
33		10	100	300	0,60	1800	B82496-A3330-J
39		11	100	300	0,80	1800	B82496-A3390-J
47		11	100	250	0,95	1800	B82496-A3470-J
56		12	100	250	1,2	1800	B82496-A3560-J
68	12	100	250	1,3	1500	B82496-A3680-J	
82	12	100	250	1,5	1500	B82496-A3820-J	
100	12	100	200	1,8	1300	B82496-A3101-J	

Engere Toleranzen auf Anfrage.
Closer tolerances upon request.

HF-Drosseln RF Chokes



Baugröße 0805
Size 0805

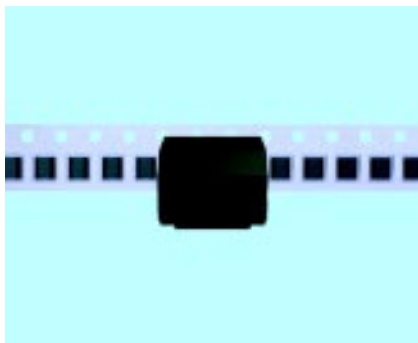

Baureihe SIMID 08-A

- Kernmaterial: Kunststoff (LCP)
- Gleiche Meßfrequenz für L und Q

Maße (mm)	$l \times b \times h$: 2,0 × 1,25 × 1,25
Anschlüsse	verzinkt
IEC-Klimakategorie	20/085/56
Lötbarkeit	IR-, Vapor-Phase-, Wellenlöten
Lieferform	8-mm-Blistergurt

SIMID 08-A series

- Core: Liquid crystal polymer (LCP)
- Same meas. frequency for L and Q

Dimensions (mm)	$l \times b \times h$: 2,0 × 1,25 × 1,25
Terminals	tinned
IEC climatic category	20/085/56
Soldering	IR, vapor phase, wave soldering
Delivery mode	8-mm blister tape

L_N L_R nH	Toleranz Tolerance	Q_{min}	$f_L; f_Q$ MHz	I_N I_R mA	R_{typ} Ω	$f_{res, min}$ MHz	Bestellnummer ¹⁾ Ordering code ¹⁾
10	±10% ≐K	12	100	540	0,15	2500	B82498-A3100-K
12		12	100	535	0,20	2500	B82498-A3120-K
15		15	100	535	0,20	2500	B82498-A3150-K
18		15	100	510	0,24	2000	B82498-A3180-K
22		15	100	495	0,24	2000	B82498-A3220-K
27		18	100	460	0,29	1800	B82498-A3270-K
33	±5% ≐J	18	100	430	0,28	1500	B82498-A3330-+
39		18	100	410	0,33	1500	B82498-A3390-+
47	±10% ≐K	18	100	390	0,38	1000	B82498-A3470-+
56		18	100	380	0,43	1000	B82498-A3560-+
68		18	100	370	0,42	800	B82498-A3680-+
82		18	100	350	0,53	800	B82498-A3820-+
100		10	25,2	300	0,58	800	B82498-A3101-+
120		10	25,2	280	0,74	600	B82498-A3121-+
150		10	25,2	235	1,12	600	B82498-A3151-+
180		10	25,2	210	1,23	600	B82498-A3181-+
220		10	25,2	200	1,41	500	B82498-A3221-+
270		10	25,2	165	1,50	300	B82498-A3271-+
330	10	25,2	185	1,67	200	B82498-A3331-+	
390	10	25,2	175	1,74	150	B82498-A3391-+	
470	10	25,2	165	1,97	150	B82498-A3471-+	
560	10	25,2	150	2,07	100	B82498-A3561-+	
680	10	25,2	150	2,32	100	B82498-A3681-+	
820	10	25,2	140	2,60	80	B82498-A3821-+	
1000	8	8	7,96	130	2,98	80	B82498-A3102-+

1) Anstelle + ist der Kennbuchstabe für die gewünschte Induktivitätstoleranz einzusetzen.
Replace the + by the code letter for the required inductance tolerance.

HF-Drosseln RF Chokes



Baugröße 0805
Size 0805

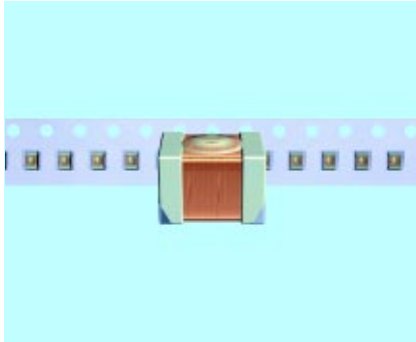

Baureihe SIMID 08-B

- Kernmaterial: Keramik oder Ferrit
- Gleiche Meßfrequenz für L und Q

Maße (mm)	$l \times b \times h$ 2,2 × 1,4 × 1,6
Anschlüsse	metallisiert
IEC-Klimakategorie	55/125/56
Lötbarkeit	IR-, Vapor-Phase-, Wellenlöten
Lieferform	8-mm-Blistergurt

SIMID 08-B series

- Core material: ceramics or ferrite
- Same meas. frequency for L and Q

Dimensions (mm)	$l \times b \times h$ 2,2 × 1,4 × 1,6
Terminals	metallized
IEC climatic category	55/125/56
Soldering	IR, vapor phase, wave soldering
Delivery mode	8-mm blister tape

L_N L_R nH	Toleranz Tolerance	Q_{min}	$f_L; f_Q$ MHz	I_N I_R mA	R_{max} Ω	$f_{res, min}$ MHz	Bestellnummer ¹⁾ Ordering code ¹⁾
2,7	±10%	20	250	1000	0,03	6000	B82498-B3279-M
5,6	±K	25	250	900	0,04	6000	B82498-B3569-M
6,8	±20%	30	250	800	0,05	5500	B82498-B3689-K
8,2	±M	35	250	700	0,06	5000	B82498-B3829-M
10	±5%	40	250	700	0,06	4500	B82498-B3100-+
12	±J	40	250	700	0,06	4000	B82498-B3120-+
15	±10%	40	250	670	0,07	3500	B82498-B3150-+
18	±K	45	250	670	0,07	3300	B82498-B3180-+
22		45	250	600	0,09	2600	B82498-B3220-+
27		50	250	600	0,09	2500	B82498-B3270-+
33		45	250	520	0,12	2150	B82498-B3330-+
39		50	250	560	0,10	2050	B82498-B3390-+
47		45	200	500	0,13	1900	B82498-B3470-+
56		45	200	480	0,14	1700	B82498-B3560-+
68		45	200	410	0,19	1550	B82498-B3680-+
82		40	150	390	0,21	1430	B82498-B3820-+
100		40	150	350	0,26	1310	B82498-B3101-+
120		40	150	270	0,44	1210	B82498-B3121-+
150		35	100	270	0,44	1120	B82498-B3151-+
180		35	100	260	0,47	1030	B82498-B3181-+
220		35	100	240	0,55	950	B82498-B3221-+
270		35	100	180	1,0	870	B82498-B3271-+
330		35	100	180	1,0	800	B82498-B3331-+
390		35	100	130	1,9	730	B82498-B3391-+
470		35	100	115	2,4	660	B82498-B3471-+
560		35	100	100	3,2	600	B82498-B3561-+
680		20	25,2	250	0,50	450	B82498-B1681-+
820		20	25,2	240	0,55	400	B82498-B1821-+
1000		20	7,96	250	0,50	350	B82498-B1102-+
1200		20	7,96	220	0,65	300	B82498-B1122-+
1500		20	7,96	200	0,75	250	B82498-B1152-+
1800		20	7,96	190	0,85	250	B82498-B1182-+
2200		20	7,96	130	1,7	200	B82498-B1222-+
2700		20	7,96	120	2,0	200	B82498-B1272-+
3300		20	7,96	100	3,3	200	B82498-B1332-+
3900		20	7,96	95	3,6	150	B82498-B1392-+
4700		20	7,96	90	3,8	150	B82498-B1472-+

1) Anstelle + ist der Kennbuchstabe für die gewünschte Induktivitätstoleranz einzusetzen. Engere Toleranzen auf Anfrage.
Replace the + by the code letter for the required inductance tolerance. Closer tolerances upon request.

HF-Drosseln RF Chokes



Baugröße 1008
Size 1008

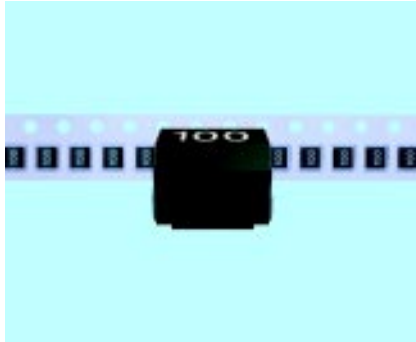

Baureihe SIMID 04	
■ Kernmaterial: Ferrit	
■ Gleiche Meßfrequenz für L und Q	
Maße (mm)	$l \times b \times h$: 2,5 × 2,0 × 1,6
Anschlüsse	verzinkt
IEC-Klimakategorie	55/085/56
Lötbarkeit	IR-, Vapor-Phase-, Wellenlöt
Lieferform	8-mm-Blistergurt

SIMID 04 series	
■ Core material: ferrite	
■ Same meas. frequency for L and Q	
Dimensions (mm)	$l \times b \times h$: 2,5 × 2,0 × 1,6
Terminals	tinned
IEC climatic category	55/085/56
Soldering	IR, vapor phase, wave soldering
Delivery mode	8-mm blister tape

$L_N^{(1)}$ $L_R^{(1)}$ μH	Toleranz Tolerance	Q_{\min}	$f_Q^{(2)}$ MHz	I_N I_R mA	R_{\max} Ω	$f_{\text{res, min}}$ MHz	Bestellnummer Ordering code
0,22	±10%	25	25,2	190	0,70	230	B82494-A1221-K
0,27	≅K	25	25,2	180	0,75	210	B82494-A1271-K
0,33		25	25,2	170	0,85	190	B82494-A1331-K
0,39		25	25,2	160	0,95	175	B82494-A1391-K
0,47		25	25,2	155	1,00	160	B82494-A1471-K
0,56		25	25,2	150	1,10	150	B82494-A1561-K
0,68		25	25,2	140	1,25	135	B82494-A1681-K
0,82		25	25,2	130	1,40	125	B82494-A1821-K
1,0		25	7,96	195	0,65	115	B82494-A1102-K
1,2		25	7,96	180	0,75	100	B82494-A1122-K
1,5		25	7,96	170	0,85	90	B82494-A1152-K
1,8		25	7,96	160	0,95	85	B82494-A1182-K
2,2		25	7,96	155	1,05	80	B82494-A1222-K
2,7		25	7,96	145	1,20	75	B82494-A1272-K
3,3		25	7,96	135	1,30	65	B82494-A1332-K
3,9		25	7,96	130	1,40	60	B82494-A1392-K
4,7		25	7,96	125	1,55	55	B82494-A1472-K
5,6		25	7,96	120	1,75	50	B82494-A1562-K
6,8		25	7,96	115	1,95	45	B82494-A1682-K
8,2		25	7,96	105	2,20	40	B82494-A1822-K
10		25	2,52	80	3,7	32	B82494-A1103-K
12		25	2,52	75	4,1	30	B82494-A1123-K
15		25	2,52	70	5,0	28	B82494-A1153-K
18		25	2,52	65	5,4	25	B82494-A1183-K
22		25	2,52	60	6,0	22	B82494-A1223-K
27		40	2,52	18	4,5	20	B82494-G1273-K
33		40	2,52	14	5,2	18	B82494-G1333-K
39		40	2,52	13	5,7	15	B82494-G1393-K
47		40	2,52	12	6,6	14	B82494-G1473-K
56		40	2,52	10	7,1	13	B82494-G1563-K
68		25	2,52	17	6,5	13	B82494-G1683-K
82		25	2,52	14	7,4	13	B82494-G1823-K
100		25	0,796	10	8,4	12	B82494-G1104-K

1) L -Meßfrequenz und L -Meßspannung wie bei Gütemessung oder
1 MHz und 0,1 V_{eff} für $L \leq 10 \mu\text{H}$ sowie 100 kHz und 0,01 V_{eff} für $L > 10 \mu\text{H}$
Frequency and voltage for measuring L same as for measuring Q or
1 MHz and 0,1 V_{rms} for $L \leq 10 \mu\text{H}$ or 100 kHz and 0,01 V_{rms} for $L > 10 \mu\text{H}$

2) Meßspannung 0,3 V_{eff}
Measuring voltage 0,3 V_{rms}

HF-Drosseln RF Chokes



Baugröße 1210
Size 1210

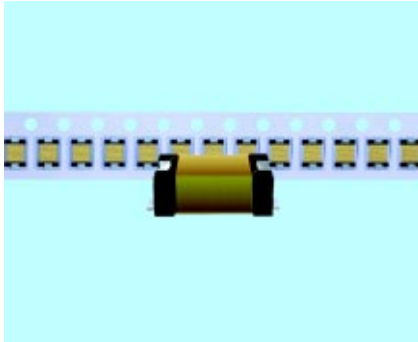

Baureihe SIMID 01

- Kernmaterial: Keramik oder Ferrit
- Sehr hohe Resonanzfrequenz

Maße (mm)	$l \times b \times h$ 3,2 × 2,5 × 1,6
Anschlüsse	versilbert
IEC-Klimakategorie	55/125/56
Lötbarkeit	IR-, Vapor-Phase-, Wellenlöten
Lieferform	8-mm-Blistergurt

SIMID 01 series

- Core material: ceramics or ferrite
- Very high resonance frequency

Dimensions (mm)	$l \times b \times h$ 2,5 × 2,0 × 1,6
Terminals	silver-plated
IEC climatic category	55/125/56
Soldering	IR, vapor phase, wave soldering
Delivery mode	8-mm blister tape

L_N L_R μH	Toleranz Tolerance	f_L MHz	Q_{min}	f_Q MHz	I_N I_R mA	R_{max} Ω	$f_{res, min}$ MHz	Bestellnummer ¹⁾ Ordering code ¹⁾
0,010	±10% ≐K	10	25	100	700	0,10	2000	B82412-A3100-K
0,012		10	25	100	700	0,10	2000	B82412-A3120-K
0,015		10	25	100	640	0,12	2000	B82412-A3150-K
0,018		10	30	100	640	0,12	2000	B82412-A3180-K
0,022	±5% ≐J	10	30	100	600	0,12	2000	B82412-A3220-+
0,027		10	20	50	600	0,15	2000	B82412-A3270-+
0,033	±10% ≐K	10	25	50	540	0,17	2000	B82412-A3330-+
0,039		10	25	50	500	0,18	1600	B82412-A3390-+
0,047		10	25	50	470	0,22	1600	B82412-A3470-+
0,056		10	30	50	460	0,23	1400	B82412-A3560-+
0,068		10	30	50	440	0,25	1350	B82412-A3680-+
0,082		10	30	50	430	0,27	1000	B82412-A3820-+
0,10		10	30	50	400	0,30	1000	B82412-A3101-+
0,12		1	25	30	380	0,35	900	B82412-A3121-+
0,15		1	25	30	370	0,36	820	B82412-A3151-+
0,18		1	25	30	340	0,42	700	B82412-A3181-+
0,22		1	25	30	320	0,48	630	B82412-A3221-+
0,27		1	30	30	300	0,55	570	B82412-A3271-+
0,33		1	30	30	280	0,65	550	B82412-A3331-+
0,39		1	30	30	260	0,75	500	B82412-A3391-+
0,47		1	30	30	225	1,00	450	B82412-A3471-+
0,56		1	30	30	200	1,20	430	B82412-A3561-+
0,68	1	30	30	180	1,40	400	B82412-A3681-+	
0,82	1	30	30	150	2,00	380	B82412-A3821-+	
1,0	±5% ≐J	1	30	7,96	330	0,45	300	B82412-A1102-+
1,2		1	30	7,96	310	0,50	260	B82412-A1122-+
1,5	±10% ≐K	1	30	7,96	300	0,55	240	B82412-A1152-+
1,8		1	30	7,96	290	0,60	220	B82412-A1182-+
2,2		1	30	7,96	270	0,65	200	B82412-A1222-+
2,7		1	30	7,96	220	1,05	180	B82412-A1272-+
3,3		1	30	7,96	200	1,10	160	B82412-A1332-+
3,9		1	30	7,96	190	1,35	150	B82412-A1392-+
4,7		1	35	7,96	160	1,80	140	B82412-A1472-+
5,6		1	35	7,96	140	2,70	125	B82412-A1562-+
6,8		1	35	7,96	120	3,50	115	B82412-A1682-+
8,2		1	35	7,96	110	3,80	100	B82412-A1822-+
10	1	35	7,96	90	5,50	95	B82412-A1103-+	

1) Anstelle + ist der Kennbuchstabe für die gewünschte Induktivitätstoleranz einzusetzen. Engere Toleranzen auf Anfrage.
(Angabe ist die Bestellnummer für Rollengröße Ø 180 mm; für Ø 330 mm ist zusätzlich die Kennziffer „8“ anzufügen. Beispiel: B82412-A3100-M8)
Replace the + by the code letter for the required inductance tolerance. Closer tolerances upon request.
(The listed ordering codes are for reel size Ø 180 mm; for Ø 330 mm append code number "8". Example: B82412-A3100-M8)

HF-Drosseln RF Chokes



Baugröße 1210
Size 1210

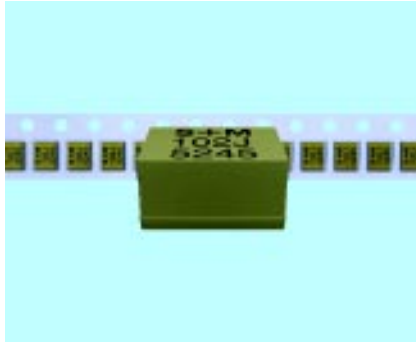

Baureihe SIMID 02-100 Baureihe SIMID 02-T

■ Kernmaterial: Keramik oder Ferrit

Maße (mm)	$l \times b \times h$: 3,2 × 2,5 × 2,0
Anschlüsse	verzinkt
IEC-Klimakategorie	55/125/56
Lötbarkeit	IR-, Vapor-Phase-, Wellenlöten
Lieferform	8-mm-Blistergurt

SIMID 02-100 series SIMID 02-T series

■ Core material: ceramics or ferrite

Dimensions (mm)	$l \times b \times h$: 3,2 × 2,5 × 2,0
Terminals	tinned
IEC climatic category	55/125/56
Soldering	IR, vapor phase, wave soldering
Delivery mode	8-mm blister tape

L_N L_R μH	Toleranz Tolerance	f_L MHz	Q_{min}	f_Q MHz	I_N I_R mA	R_{max} Ω	$f_{res, min}$ MHz	Bestellnummer ¹⁾ Ordering code ¹⁾
----------------------	-----------------------	--------------	-----------	--------------	----------------------	----------------	-----------------------	--

Baureihe SIMID 02-100 (unterschiedliche Meßfrequenz für L und Q) SIMID 02-100 series (different measuring frequencies for L and Q)

0,0082	±5%	10	20	100	800	0,08	2500	B82422-A3829-+100
0,010	≅J	10	20	100	750	0,09	2500	B82422-A3100-+100
0,012	±10%	10	25	100	700	0,10	2500	B82422-A3120-+100
0,015	≅K	10	27	100	640	0,12	2500	B82422-A3150-+100
0,018		10	30	100	640	0,12	2500	B82422-A3180-+100
0,022		10	30	100	600	0,14	2500	B82422-A3220-+100
0,027		10	23	50	600	0,14	1850	B82422-A3270-+100
0,033		10	20	50	540	0,17	1700	B82422-A3330-+100
0,039		10	25	50	530	0,18	1450	B82422-A3390-+100
0,047		10	26	50	510	0,19	1350	B82422-A3470-+100
0,056		10	26	50	500	0,20	1200	B82422-A3560-+100
0,068		10	27	50	480	0,21	1150	B82422-A3680-+100
0,082		10	27	50	450	0,24	1050	B82422-A3820-+100
0,10		10	25	50	440	0,26	1000	B82422-A3101-+100
0,12		1	22	30	400	0,32	880	B82422-A3121-+100
0,15		1	25	30	390	0,33	850	B82422-A3151-+100
0,18		1	25	30	360	0,38	800	B82422-A3181-+100
0,22		1	25	30	280	0,64	700	B82422-A3221-+100
0,27		1	20	30	235	0,90	650	B82422-A3271-+100
0,33		1	22	30	200	1,3	580	B82422-A3331-+100
0,39		1	22	30	190	1,4	540	B82422-A3391-+100
0,47		1	22	30	150	2,2	480	B82422-A3471-+100
0,56		1	22	30	150	2,2	400	B82422-A3561-+100
0,68		1	22	30	145	2,4	180	B82422-A3681-+100
0,82		1	22	30	140	2,5	160	B82422-A3821-+100
1,0	±5%	1	20	7,96	380	0,34	320	B82422-A1102-+100
1,2	≅J	1	20	7,96	370	0,37	300	B82422-A1122-+100
1,5	±10%	1	20	7,96	340	0,42	270	B82422-A1152-+100
1,8	≅K	1	25	7,96	290	0,60	250	B82422-A1182-+100
2,2		1	25	7,96	270	0,75	125	B82422-A1222-+100
2,7		1	25	7,96	240	0,88	110	B82422-A1272-+100
3,3		1	27	7,96	200	1,20	110	B82422-A1332-+100
3,9		1	27	7,96	190	1,40	110	B82422-A1392-+100
4,7		1	27	7,96	150	2,20	110	B82422-A1472-+100
5,6		1	27	7,96	140	2,60	100	B82422-A1562-+100

1) Bildung der Bestellnummer siehe Seite 14.
For instructions on how to determine ordering codes, refer to page 14.

HF-Drosseln RF Chokes



Baugröße 1210
Size 1210

L_N L_R μH	Toleranz Tolerance	f_L MHz	Q_{\min}	f_Q MHz	I_N I_R mA	R_{\max} Ω	$f_{\text{res, min}}$ MHz	Bestellnummer ¹⁾ Ordering code ¹⁾
---------------------------------	-----------------------	--------------	------------	--------------	----------------------	------------------------	------------------------------	--

Baureihe SIMID 02-100 (Fortsetzung) SIMID 02-100 series (continued)

6,8	$\pm 5\%$	1	27	7,96	135	2,80	90	B82422-A1682-+100
8,2	$\hat{=} J$	1	27	7,96	130	3,00	90	B82422-A1822-+100
10	$\pm 10\%$	1	27	2,52	180	1,60	25	B82422-A1103-+100
12	$\hat{=} K$	0,1	27	2,52	175	1,65	23	B82422-A1123-+100
15		0,1	27	2,52	165	1,85	20	B82422-A1153-+100
18		0,1	27	2,52	155	2,00	17	B82422-A1183-+100
22		0,1	27	2,52	140	2,65	16	B82422-A1223-+100
27		0,1	27	2,52	120	3,70	15	B82422-A1273-+100
33		0,1	27	2,52	105	4,50	13	B82422-A1333-+100
39		0,1	27	2,52	90	6,30	12	B82422-A1393-+100
47		0,1	27	2,52	85	7,00	11	B82422-A1473-+100
56		0,1	27	2,52	85	6,75	9	B82422-A1563-+100
68		0,1	27	2,52	80	7,70	9	B82422-A1683-+100
82		0,1	27	2,52	70	10,0	8	B82422-A1823-+100
100		0,1	27	2,52	65	11,5	7	B82422-A1104-+100

Baureihe SIMID 02-T (gleiche Meßfrequenz für L und Q) SIMID 02-T series (same measuring frequency for L and Q)

0,010	$\pm 5\%$	100	15	100	450	0,10	2500	B82422-T3100-+
0,012	$\hat{=} J$	100	17	100	450	0,11	2500	B82422-T3120-+
0,015	$\pm 10\%$	100	19	100	450	0,13	2500	B82422-T3150-+
0,018	$\hat{=} K$	100	21	100	450	0,14	2000	B82422-T3180-+
0,022		100	23	100	450	0,16	2000	B82422-T3220-+
0,027		100	23	100	450	0,17	1700	B82422-T3270-+
0,033		100	25	100	450	0,18	1700	B82422-T3330-+
0,039		100	25	100	450	0,19	1300	B82422-T3390-+
0,047		100	26	100	450	0,20	1300	B82422-T3470-+
0,056		100	26	100	450	0,21	1100	B82422-T3560-+
0,068		100	27	100	450	0,23	1000	B82422-T3680-+
0,082		100	27	100	450	0,26	1000	B82422-T3820-+
0,10		100	28	100	450	0,31	900	B82422-T3101-+
0,12	$\pm 5\%$	25,2	30	25,2	450	0,15	900	B82422-T1121-+
0,15	$\hat{=} J$	25,2	30	25,2	450	0,18	700	B82422-T1151-+
0,18	$\pm 10\%$	25,2	30	25,2	450	0,19	500	B82422-T1181-+
0,22	$\hat{=} K$	25,2	30	25,2	450	0,20	500	B82422-T1221-+
0,27		25,2	30	25,2	450	0,21	500	B82422-T1271-+
0,33		25,2	30	25,2	450	0,23	500	B82422-T1331-+
0,39		25,2	30	25,2	450	0,25	400	B82422-T1391-+
0,47		25,2	30	25,2	450	0,30	400	B82422-T1471-+
0,56		25,2	30	25,2	450	0,31	300	B82422-T1561-+
0,68		25,2	30	25,2	450	0,34	300	B82422-T1681-+
0,82		25,2	30	25,2	450	0,38	300	B82422-T1821-+
1,0		7,96	30	7,96	400	0,6	300	B82422-T1102-+
1,2		7,96	30	7,96	390	0,7	250	B82422-T1122-+
1,5		7,96	30	7,96	370	0,7	200	B82422-T1152-+
1,8		7,96	30	7,96	350	0,8	140	B82422-T1182-+
2,2		7,96	30	7,96	320	0,8	100	B82422-T1222-+
2,7		7,96	30	7,96	290	0,9	70	B82422-T1272-+

1) Bildung der Bestellnummer siehe Seite 14.
For instructions on how to determine ordering codes, refer to page 14.

HF-Drosseln RF Chokes



Baugröße 1210
Size 1210

L_N L_R μH	Toleranz Tolerance	f_L MHz	Q_{\min}	f_Q MHz	I_N I_R mA	R_{\max} Ω	$f_{\text{res, min}}$ MHz	Bestellnummer ¹⁾ Ordering code ¹⁾
---------------------------------	-----------------------	--------------	------------	--------------	----------------------	------------------------	------------------------------	--

Baureihe SIMID 02-T (Fortsetzung) SIMID 02-T series (continued)

3,3	±5%	7,96	30	7,96	260	1,2	60	B82422-T1332-+
3,9	±J	7,96	30	7,96	250	1,3	60	B82422-T1392-+
4,7	±10%	7,96	30	7,96	220	1,5	50	B82422-T1472-+
5,6	±K	7,96	27	7,96	200	1,6	45	B82422-T1562-+
6,8		7,96	27	7,96	180	1,8	40	B82422-T1682-+
8,2		7,96	27	7,96	170	2,0	35	B82422-T1822-+
10		2,52	27	2,52	150	2,1	30	B82422-T1103-+
12		2,52	27	2,52	140	2,5	25	B82422-T1123-+
15		2,52	27	2,52	130	2,8	20	B82422-T1153-+
18		2,52	27	2,52	120	3,0	20	B82422-T1183-+
22		2,52	27	2,52	110	3,5	20	B82422-T1223-+
27		2,52	27	2,52	80	4,5	20	B82422-T1273-+
33		2,52	27	2,52	70	5,6	17	B82422-T1333-+
39		2,52	27	2,52	65	6,4	16	B82422-T1393-+
47		2,52	27	2,52	60	7,0	15	B82422-T1473-+
56		2,52	27	2,52	55	8,0	12	B82422-T1563-+
68		2,52	27	2,52	50	9,0	9	B82422-T1683-+
82		2,52	25	2,52	45	10	9	B82422-T1823-+
100		0,796	20	0,796	40	11	8	B82422-T1104-+

1) Anstelle + ist der Kennbuchstabe für die gewünschte Induktivitätstoleranz einzusetzen. Engere Toleranzen auf Anfrage.
(Bestellnummer für Rollengröße Ø 180 mm; für Ø 330 mm steht an letzter Stelle die Kennziffer „8“. Beispiele: B82422-A3829-K108, B82422-T1332-K8)
Replace the + by the code letter for the required inductance tolerance. Closer tolerances upon request.
(The listed ordering codes are for reel size Ø 180 mm; for Ø 330 mm the last digit of the ordering code has to be an "8".
Examples: B82422-A3829-K108, B82422-T1332-K8)

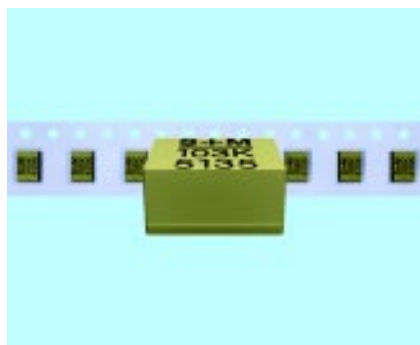

Baureihe SIMID 02

Die Baugröße 1210 ist auch mit **versilberten** Anschlüssen lieferbar.

- Unterschiedliche Meßfrequenzen für L und Q
- $L_N = 0,0082 \dots 100 \mu\text{H}$
- $I_N = 65 \dots 700 \text{ mA}$

SIMID 02 series

Size 1210 is also available with **silver-plated** terminals.

- Different measuring frequencies for L and Q
- $L_R = 0,0082 \dots 100 \mu\text{H}$
- $I_R = 65 \dots 700 \text{ mA}$

HF-Drosseln RF Chokes



Baugröße 1812
Size 1812



Baureihe SIMID 03

- Kernmaterial: Ferrit
- Hohe Strombelastbarkeit

Maße (mm)	$l \times b \times h$ 4,5 × 3,2 × 3,2
Anschlüsse	versilbert
IEC-Klimakategorie	55/125/56
Lötbarkeit	IR-, Vapor-Phase-, Wellenlöten
Lieferform	12-mm-Blistergurt

SIMID 03 series

- Core material: ferrite
- High current handling capability

Dimensions (mm)	$l \times b \times h$ 4,5 × 3,2 × 3,2
Terminals	silver-plated
IEC climatic category	55/125/56
Soldering	IR, vapor phase, wave soldering
Delivery mode	12-mm blister tape

L_N L_R μH	Toleranz Tolerance	f_L MHz	Q_{min}	f_Q MHz	I_N I_R mA	R_{max} Ω	$f_{res, min}$ MHz	Bestellnummer ¹⁾ Ordering code ¹⁾
1,0	±10% ≐K	1	25	7,96	600	0,28	260	B82432-A1102-K
1,2		1	25	7,96	560	0,32	250	B82432-A1122-K
1,5		1	25	7,96	535	0,35	230	B82432-A1152-K
1,8		1	25	7,96	490	0,41	210	B82432-A1182-K
2,2		1	30	7,96	480	0,43	190	B82432-A1222-K
2,7		1	30	7,96	450	0,49	170	B82432-A1272-K
3,3		1	30	7,96	425	0,55	155	B82432-A1332-K
3,9		1	30	7,96	410	0,59	145	B82432-A1392-K
4,7		1	30	7,96	390	0,65	110	B82432-A1472-K
5,6		1	30	7,96	375	0,71	100	B82432-A1562-K
6,8		1	30	7,96	360	0,78	75	B82432-A1682-K
8,2		1	30	7,96	330	0,92	23	B82432-A1822-K
10		1	45	2,52	320	0,98	22	B82432-A1103-K
12		0,1	45	2,52	300	1,10	19	B82432-A1123-K
15		0,1	45	2,52	280	1,25	17	B82432-A1153-K
18		0,1	45	2,52	270	1,35	15	B82432-A1183-K
22		0,1	45	2,52	260	1,45	13	B82432-A1223-K
27	0,1	45	2,52	245	1,65	12	B82432-A1273-K	
33	±5% ≐J	0,1	45	2,52	230	1,85	10,5	B82432-A1333-+
39		0,1	45	2,52	220	2,05	10,0	B82432-A1393-+
47	±10% ≐K	0,1	40	2,52	210	2,3	9,5	B82432-A1473-+
56		0,1	40	2,52	200	2,5	9,0	B82432-A1563-+
68		0,1	40	2,52	190	2,8	8,0	B82432-A1683-+
82		0,1	35	2,52	175	3,2	7,0	B82432-A1823-+
100		0,1	40	2,52	145	4,7	6,5	B82432-A1104-+
120		0,1	35	0,796	140	5,2	6,0	B82432-A1124-+
150		0,1	35	0,796	130	6,1	5,5	B82432-A1154-+
180		0,1	35	0,796	120	6,9	5,0	B82432-A1184-+
220		0,1	30	0,796	115	7,5	4,6	B82432-A1224-+
270		0,1	30	0,796	90	12,5	4,4	B82432-A1274-+
330		0,1	30	0,796	85	14,1	4,1	B82432-A1334-+
390		0,1	35	0,796	80	15,3	3,8	B82432-A1394-+
470		0,1	35	0,796	75	17,5	3,5	B82432-A1474-+
560		0,1	30	0,796	70	23,0	2,8	B82432-A1564-+
680		0,1	30	0,796	65	25,0	2,6	B82432-A1684-+
820		0,1	30	0,796	60	28,0	2,5	B82432-A1824-+
1000		0,1	30	0,796	55	32,0	2,3	B82432-A1105-+

1) Anstelle + ist der Kennbuchstabe für die gewünschte Induktivitätstoleranz einzusetzen. Engere Toleranzen auf Anfrage.
Replace the + by the code letter for the required inductance tolerance. Closer tolerances upon request.

HF-Drosseln RF Chokes



Baugröße 2220
Size 2220

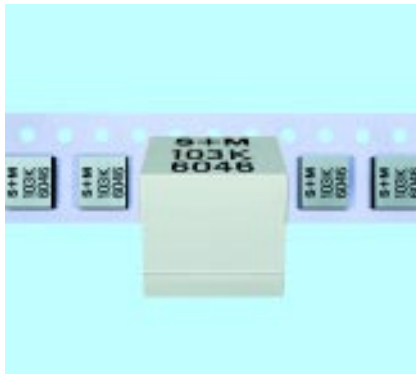

Baureihe SIMID 05

- Kernmaterial: Ferrit
- Sieben von Versorgungsspannungen bei hohen Strömen

Maße (mm)	$l \times b \times h$ 5,6 × 5,0 × 5,0
Anschlüsse	verzinkt
IEC-Klimakategorie	55/125/56
Lötbarkeit	IR-, Vapor-Phase-, Wellenlöten
Lieferform	12-mm-Blistergurt

SIMID 05 series

- Core material: ferrite
- Filtering of supply voltages at high currents

Dimensions (mm)	$l \times b \times h$ 5,6 × 5,0 × 5,0
Terminals	tinned
IEC climatic category	55/125/56
Soldering	IR, vapor phase, wave soldering
Delivery mode	12-mm blister tape

L_N L_R μH	Toleranz Tolerance	Q_{\min}	$f_L; f_Q$ MHz	I_N I_R mA	R_{\max} Ω	$f_{\text{res, min}}$ MHz	Bestellnummer ¹⁾ Ordering code ¹⁾
1,0	±10%	10	7,96	1800	0,024	95	B82442-A1102-K
1,2	≐K	10	7,96	1700	0,028	70	B82442-A1122-K
1,5		10	7,96	1600	0,032	55	B82442-A1152-K
1,8		10	7,96	1400	0,040	47	B82442-A1182-K
2,2		10	7,96	1300	0,048	42	B82442-A1222-K
2,7		10	7,96	1200	0,056	37	B82442-A1272-K
3,3		10	7,96	1120	0,064	34	B82442-A1332-K
3,9		10	7,96	1050	0,072	32	B82442-A1392-K
4,7		10	7,96	950	0,088	29	B82442-A1472-K
5,6		10	7,96	880	0,104	26	B82442-A1562-K
6,8		10	7,96	810	0,120	24	B82442-A1682-K
8,2		10	7,96	750	0,144	22	B82442-A1822-K
10		10	2,52	690	0,168	19	B82442-A1103-K
12		10	2,52	630	0,20	17	B82442-A1123-K
15		10	2,52	580	0,24	16	B82442-A1153-K
18		10	2,52	530	0,29	14	B82442-A1183-K
22		10	2,52	480	0,35	13	B82442-A1223-K
27		10	2,52	440	0,42	11,5	B82442-A1273-K
33	±5%	10	2,52	400	0,50	10,5	B82442-A1333-+
39	≐J	10	2,52	370	0,58	9,5	B82442-A1393-+
47	±10%	10	2,52	340	0,68	8,5	B82442-A1473-+
56	≐K	10	2,52	310	0,80	7,8	B82442-A1563-+
68		10	2,52	290	0,96	7,0	B82442-A1683-+
82		10	2,52	270	1,12	6,4	B82442-A1823-+
100		20	0,796	250	1,28	6,0	B82442-A1104-+
120		20	0,796	230	1,52	5,4	B82442-A1124-+
150		20	0,796	210	1,76	4,8	B82442-A1154-+
180		20	0,796	190	2,24	4,4	B82442-A1184-+
220		20	0,796	170	2,72	3,9	B82442-A1224-+
270		20	0,796	155	3,36	3,6	B82442-A1274-+
330		20	0,796	140	3,92	3,2	B82442-A1334-+
390		20	0,796	130	4,64	2,9	B82442-A1394-+
470		20	0,796	120	5,60	2,6	B82442-A1474-+
560		20	0,796	110	6,80	2,4	B82442-A1564-+
680		20	0,796	100	8,00	2,2	B82442-A1684-+
820		20	0,796	90	10,4	2,0	B82442-A1824-+

1) Bildung der Bestellnummer siehe Seite 17.
For instructions on how to determine ordering codes, refer to page 17.

HF-Drosseln RF Chokes



Baugröße 2220
Size 2220

L_N L_R μH	Toleranz Tolerance	Q_{\min}	$f_L; f_Q$ MHz	I_N I_R mA	R_{\max} Ω	$f_{\text{res, min}}$ MHz	Bestellnummer ¹⁾ Ordering code ¹⁾
1000	$\pm 5\%$	30	0,252	85	12,0	1,8	B82442-A1105-+
1200	$\pm J$	30	0,252	75	13,6	1,5	B82442-A1125-+
1500	$\pm 10\%$	30	0,252	70	16,0	1,4	B82442-A1155-+
1800	$\pm K$	30	0,252	60	24,0	1,3	B82442-A1185-+
2200		30	0,252	55	28,0	1,2	B82442-A1225-+
2700		30	0,252	45	44,0	1,1	B82442-A1275-+
3300		30	0,252	40	48,0	1,0	B82442-A1335-+
3900		30	0,252	38	56,0	1,0	B82442-A1395-+
4700		30	0,252	36	62,4	0,9	B82442-A1475-+
5600		30	0,252	33	68,0	0,8	B82442-A1565-+
6800		30	0,252	30	88,0	0,7	B82442-A1685-+
8200		30	0,252	28	100	0,6	B82442-A1825-+
10000		30	0,0796	25	120	0,5	B82442-A1106-+

1) Anstelle + ist der Kennbuchstabe für die gewünschte Induktivitätstoleranz einzusetzen. Engere Toleranzen auf Anfrage.
Replace the + by the code letter for the required inductance tolerance. Closer tolerances upon request.

HF-Drosseln RF Chokes

Bedrahtet / Leaded
Mini-Cylinder-Core

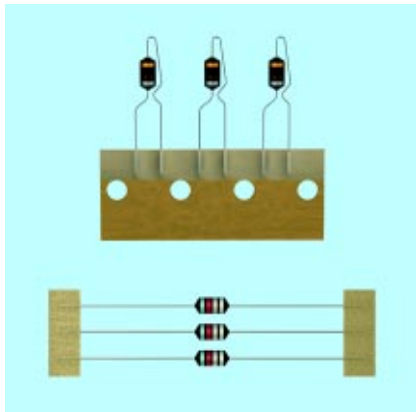

Baureihe MCC

■ Zylinderkern aus Keramik oder Ferrit

Maße (mm)	$\varnothing \times l: 3,3 \times 7,0$
IEC-Klimakategorie	55/125/56
Lieferform	axial oder radial gegurtet
Rastermaß	axial: min. 10 mm radial: 5 mm

MCC series

■ Ceramic oder ferrite cylinder core

Dimensions (mm)	$\varnothing \times l: 3,3 \times 7,0$
IEC climatic category	55/125/56
Delivery mode	axially or radially taped
Lead spacing	axial: min. 10 mm radial: 5 mm

L_N L_R μH	Toleranz Tolerance	f_L MHz	Q_{min}	f_Q MHz	I_N I_R mA	R_{max} Ω	$f_{res, min}$ MHz	Bestellnummer Ordering code	
								Axial	Radial
0,10	$\pm 10\%$ $\cong K$	1,0	40	25,2	1120	0,13	600	B78108-T3101-K	B78148-T3101-K
0,12		1,0	40	25,2	1080	0,145	570	B78108-T3121-K	B78148-T3121-K
0,15		1,0	38	25,2	1020	0,155	500	B78108-T3151-K	B78148-T3151-K
0,18		1,0	35	25,2	1000	0,17	460	B78108-T3181-K	B78148-T3181-K
0,22		1,0	35	25,2	990	0,195	420	B78108-T3221-K	B78148-T3221-K
0,27		1,0	35	25,2	910	0,215	380	B78108-T3271-K	B78148-T3271-K
0,33		1,0	35	25,2	830	0,24	330	B78108-T3331-K	B78148-T3331-K
0,39		1,0	35	25,2	790	0,27	300	B78108-T3391-K	B78148-T3391-K
0,47		1,0	35	25,2	750	0,315	280	B78108-T3471-K	B78148-T3471-K
0,56		1,0	35	25,2	700	0,34	260	B78108-T3561-K	B78148-T3561-K
0,68		1,0	35	25,2	530	0,48	240	B78108-T3681-K	B78148-T3681-K
0,82		1,0	35	25,2	500	0,55	230	B78108-T3821-K	B78148-T3821-K
1,0		1,0	35	25,2	630	0,25	180	B78108-T1102-K	B78148-T1102-K
1,2		1,0	40	7,96	610	0,25	170	B78108-T1122-K	B78148-T1122-K
1,5		1,0	40	7,96	570	0,30	150	B78108-T1152-K	B78148-T1152-K
1,8	1,0	40	7,96	540	0,30	130	B78108-T1182-K	B78148-T1182-K	
2,2	1,0	40	7,96	520	0,35	120	B78108-T1222-K	B78148-T1222-K	
2,7	1,0	40	7,96	480	0,40	110	B78108-T1272-K	B78148-T1272-K	
3,3	1,0	40	7,96	420	0,50	110	B78108-T1332-K	B78148-T1332-K	
3,9	1,0	40	7,96	400	0,55	100	B78108-T1392-K	B78148-T1392-K	
4,7	1,0	40	7,96	380	0,65	90	B78108-T1472-K	B78148-T1472-K	
5,6	1,0	45	7,96	260	1,30	75	B78108-T1562-K	B78148-T1562-K	
6,8	1,0	45	7,96	250	1,45	70	B78108-T1682-K	B78148-T1682-K	
8,2	1,0	50	7,96	240	1,60	65	B78108-T1822-K	B78148-T1822-K	
10	1,0	50	7,96	230	1,70	60	B78108-T1103-K	B78148-T1103-K	
12	0,10	55	2,52	190	2,40	50	B78108-T1123-K	B78148-T1123-K	
15	0,10	55	2,52	185	2,70	45	B78108-T1153-K	B78148-T1153-K	
18	0,10	55	2,52	175	2,90	40	B78108-T1183-K	B78148-T1183-K	
22	0,10	60	2,52	170	3,20	30	B78108-T1223-K	B78148-T1223-K	
27	0,10	60	2,52	160	3,60	27	B78108-T1273-K	B78148-T1273-K	
33	0,10	60	2,52	150	4,10	24	B78108-T1333-K	B78148-T1333-K	
39	0,10	60	2,52	140	4,50	22	B78108-T1393-K	B78148-T1393-K	
47	0,10	60	2,52	100	8,50	20	B78108-T1473-K	B78148-T1473-K	
56	0,10	60	2,52	100	8,80	18	B78108-T1563-K	B78148-T1563-K	
68	0,10	60	2,52	95	10,0	15	B78108-T1683-K	B78148-T1683-K	
82	0,10	60	2,52	90	11,5	14	B78108-T1823-K	B78148-T1823-K	
100	0,10	60	2,52	85	12,5	11	B78108-T1104-K	B78148-T1104-K	

HF-Drosseln RF Chokes

Bedrahtet / Leaded
Small-Bobbin-Core

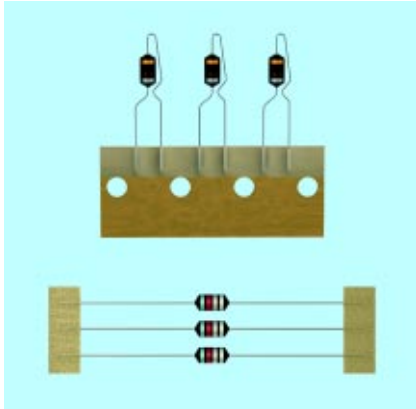

Baureihe SBC

■ Mini-Rollenkern aus Ferrit

Maße (mm) $\varnothing \times l$: 3,0 × 6,8
IEC-Klimakategorie 55/125/56
Lieferform axial oder radial
gegurtet
Rastermaß axial: min. 10 mm
radial: 5 mm

SBC series

■ Mini ferrite bobbin core

Dimensions (mm) $\varnothing \times l$: 3,0 × 6,8
IEC climatic category 55/125/56
Delivery mode axially or radially
taped
Lead spacing axial: min. 10 mm
radial: 5 mm

L_N L_R μH	Toleranz Tolerance	f_L MHz	Q_{\min}	f_Q MHz	I_N I_R mA	R_{\max} Ω	$f_{\text{res, min}}$ MHz	Bestellnummer Ordering code	
								Axial	Radial
1,0	±10% ≐K	1,0	40	7,96	725	0,19	180	B82141-A1102-K	B82141-B1102-K
1,2		1,0	40	7,96	700	0,20	160	B82141-A1122-K	B82141-B1122-K
1,5		1,0	40	7,96	670	0,22	155	B82141-A1152-K	B82141-B1152-K
1,8		1,0	45	7,96	660	0,23	145	B82141-A1182-K	B82141-B1182-K
2,2		1,0	45	7,96	630	0,25	130	B82141-A1222-K	B82141-B1222-K
2,7		1,0	45	7,96	610	0,27	110	B82141-A1272-K	B82141-B1272-K
3,3		1,0	50	7,96	580	0,30	90	B82141-A1332-K	B82141-B1332-K
3,9		1,0	50	7,96	560	0,32	70	B82141-A1392-K	B82141-B1392-K
4,7		1,0	50	7,96	530	0,36	60	B82141-A1472-K	B82141-B1472-K
5,6		1,0	50	7,96	510	0,38	50	B82141-A1562-K	B82141-B1562-K
6,8		1,0	50	7,96	480	0,43	40	B82141-A1682-K	B82141-B1682-K
8,2		1,0	50	7,96	450	0,52	30	B82141-A1822-K	B82141-B1822-K
10		1,0	55	2,52	410	0,60	25	B82141-A1103-K	B82141-B1103-K
12		0,10	55	2,52	385	0,67	20	B82141-A1123-K	B82141-B1123-K
15		0,10	55	2,52	365	0,74	17	B82141-A1153-K	B82141-B1153-K
18		0,10	55	2,52	350	0,81	14	B82141-A1183-K	B82141-B1183-K
22		0,10	55	2,52	335	0,90	12	B82141-A1223-K	B82141-B1223-K
27		0,10	55	2,52	315	1,00	11	B82141-A1273-K	B82141-B1273-K
33		0,10	55	2,52	300	1,12	10	B82141-A1333-K	B82141-B1333-K
39	0,10	55	2,52	285	1,21	8,5	B82141-A1393-K	B82141-B1393-K	
47	±5% ≐J	0,10	55	2,52	200	2,40	7,7	B82141-A1473-J	B82141-B1473-J
56		0,10	55	2,52	195	2,60	6,8	B82141-A1563-J	B82141-B1563-J
68		0,10	55	2,52	185	2,90	5,7	B82141-A1683-J	B82141-B1683-J
82		0,10	55	2,52	175	3,20	5,5	B82141-A1823-J	B82141-B1823-J
100		0,10	60	0,796	170	3,50	5,3	B82141-A1104-J	B82141-B1104-J
120		0,10	60	0,796	160	3,80	5,0	B82141-A1124-J	B82141-B1124-J
150		0,10	60	0,796	150	4,30	4,6	B82141-A1154-J	B82141-B1154-J
180		0,10	60	0,796	135	5,30	4,2	B82141-A1184-J	B82141-B1184-J
220		0,10	60	0,796	130	5,80	3,8	B82141-A1224-J	B82141-B1224-J
270		0,10	60	0,796	115	7,80	3,2	B82141-A1274-J	B82141-B1274-J
330		0,10	60	0,796	105	9,10	3,0	B82141-A1334-J	B82141-B1334-J
390		0,10	60	0,796	95	11,0	2,7	B82141-A1394-J	B82141-B1394-J
470		0,10	60	0,796	90	12,0	2,3	B82141-A1474-J	B82141-B1474-J
560		0,10	60	0,796	75	16,5	2,2	B82141-A1564-J	B82141-B1564-J
680		0,10	60	0,796	65	22,0	2,0	B82141-A1684-J	B82141-B1684-J
820	0,10	60	0,796	60	25,0	1,8	B82141-A1824-J	B82141-B1824-J	
1000	0,10	60	0,796	55	33,0	1,5	B82141-A1105-J	B82141-B1105-J	

HF-Drosseln RF Chokes

Bedrahtet / Leaded
Bobbin-Core

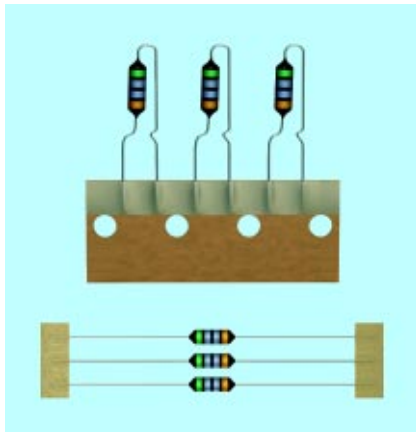

Baureihe BC

■ Rollenkern aus Ferrit

Baureihe HBC

■ BC-Drossel mit höherem Nennstrom

Maße (mm) $\varnothing \times l$: 4,0 × 9,2
IEC-Klimakategorie 55/125/56
Lieferform axial oder radial
gegurtet
Rastermaß axial:
min. 12,5 mm
radial: 5 mm

BC series

■ Ferrite bobbin core

HBC series

■ BC choke with higher rated current

Dimensions (mm) $\varnothing \times l$: 4,0 × 9,2
IEC climatic category 55/125/56
Delivery mode axially or radially
taped
Lead spacing axial:
min. 12,5 mm
radial: 5 mm

L_N L_R μH	Toleranz Tolerance	f_L MHz	Q_{\min}	f_Q MHz	I_N I_R mA	R_{\max} Ω	$f_{\text{res, min}}$ MHz	Bestellnummer Ordering code	Axial	Radial
---------------------------------	-----------------------	--------------	------------	--------------	----------------------	------------------------	------------------------------	--------------------------------	-------	--------

Baureihe BC

BC series

1,0	±10% ≐K	1,0	55	7,96	1200	0,16	205	B78108-S1102-K	B78148-S1102-K
1,2		1,0	55	7,96	1150	0,18	185	B78108-S1122-K	B78148-S1122-K
1,5		1,0	55	7,96	1100	0,20	165	B78108-S1152-K	B78148-S1152-K
1,8		1,0	55	7,96	1030	0,22	155	B78108-S1182-K	B78148-S1182-K
2,2		1,0	55	7,96	1000	0,25	140	B78108-S1222-K	B78148-S1222-K
2,7		1,0	60	7,96	940	0,26	125	B78108-S1272-K	B78148-S1272-K
3,3		1,0	60	7,96	900	0,29	115	B78108-S1332-K	B78148-S1332-K
3,9		1,0	60	7,96	850	0,31	105	B78108-S1392-K	B78148-S1392-K
4,7		1,0	60	7,96	820	0,34	95	B78108-S1472-K	B78148-S1472-K
5,6		1,0	60	7,96	780	0,38	85	B78108-S1562-K	B78148-S1562-K
6,8		1,0	65	7,96	670	0,51	75	B78108-S1682-K	B78148-S1682-K
8,2		1,0	65	7,96	690	0,48	50	B78108-S1822-K	B78148-S1822-K
10		1,0	70	2,52	680	0,49	35	B78108-S1103-K	B78148-S1103-K
12		0,10	70	2,52	650	0,55	30	B78108-S1123-K	B78148-S1123-K
15		0,10	60	2,52	610	0,60	20	B78108-S1153-K	B78148-S1153-K
18		0,10	60	2,52	580	0,67	17	B78108-S1183-K	B78148-S1183-K
22		0,10	55	2,52	560	0,74	13	B78108-S1223-K	B78148-S1223-K
27		0,10	55	2,52	530	0,83	10	B78108-S1273-K	B78148-S1273-K
33		0,10	55	2,52	500	0,92	9,0	B78108-S1333-K	B78148-S1333-K
39	0,10	50	2,52	470	1,02	8,0	B78108-S1393-K	B78148-S1393-K	
47	±5% ≐J	0,10	45	2,52	450	1,10	7,5	B78108-S1473-J	B78148-S1473-J
56		0,10	40	2,52	430	1,23	7,0	B78108-S1563-J	B78148-S1563-J
68		0,10	40	2,52	410	1,35	6,5	B78108-S1683-J	B78148-S1683-J
82		0,10	35	2,52	390	1,54	6,0	B78108-S1823-J	B78148-S1823-J
100		0,10	70	0,796	370	1,70	5,0	B78108-S1104-J	B78148-S1104-J
120		0,10	70	0,796	300	2,40	4,5	B78108-S1124-J	B78148-S1124-J
150		0,10	70	0,796	280	2,80	4,2	B78108-S1154-J	B78148-S1154-J
180		0,10	70	0,796	270	3,00	3,9	B78108-S1184-J	B78148-S1184-J
220		0,10	70	0,796	250	3,30	3,7	B78108-S1224-J	B78148-S1224-J
270		0,10	70	0,796	200	5,70	2,8	B78108-S1274-J	B78148-S1274-J
330		0,10	70	0,796	190	6,40	2,7	B78108-S1334-J	B78148-S1334-J
390		0,10	70	0,796	180	7,00	2,4	B78108-S1394-J	B78148-S1394-J
470		0,10	70	0,796	170	7,90	2,2	B78108-S1474-J	B78148-S1474-J
560		0,10	60	0,796	160	8,80	2,0	B78108-S1564-J	B78148-S1564-J

HF-Drosseln

RF Chokes

Bedrahtet / Leaded
Bobbin-Core

L_N L_R μH	Toleranz Tolerance	f_L MHz	Q_{\min}	f_Q MHz	I_N I_R mA	R_{\max} Ω	$f_{\text{res, min}}$ MHz	Bestellnummer Ordering code	
								Axial	Radial

Baureihe BC (Fortsetzung) BC series (continued)

680	$\pm 5\%$	0,10	55	0,796	150	10,0	1,9	B78108-S1684-J	B78148-S1684-J
820	$\triangleq J$	0,10	50	0,796	140	12,0	1,6	B78108-S1824-J	B78148-S1824-J
1000		0,10	50	0,252	130	14,0	1,6	B78108-S1105-J	B78148-S1105-J
1200		0,10	50	0,252	115	17,5	1,3	B78108-S1125-J	B78148-S1125-J
1500		0,10	50	0,252	100	23,0	1,25	B78108-S1155-J	B78148-S1155-J
1800		0,10	50	0,252	95	26,0	1,2	B78108-S1185-J	B78148-S1185-J
2200		0,10	40	0,252	80	34,7	1,1	B78108-S1225-J	B78148-S1225-J
2700		0,10	40	0,252	75	40,0	1,0	B78108-S1275-J	B78148-S1275-J
3300		0,10	40	0,252	62	59,5	0,9	B78108-S1335-J	B78148-S1335-J
3900		0,10	40	0,252	59	66,0	0,8	B78108-S1395-J	B78148-S1395-J
4700		0,10	35	0,252	55	78,0	0,7	B78108-S1475-J	B78148-S1475-J

Baureihe HBC (BC-Drossel mit höherem Nennstrom) HBC series (BC choke with higher rated current)

1,0	$\pm 10\%$	1,0	50	7,96	2000	0,08	195	B82143-A1102-K	B82143-B1102-K
1,2	$\triangleq K$	1,0	50	7,96	1800	0,09	180	B82143-A1122-K	B82143-B1122-K
1,5		1,0	50	7,96	1700	0,10	165	B82143-A1152-K	B82143-B1152-K
1,8		1,0	50	7,96	1650	0,11	155	B82143-A1182-K	B82143-B1182-K
2,2		1,0	50	7,96	1600	0,12	140	B82143-A1222-K	B82143-B1222-K
2,7		1,0	50	7,96	1500	0,13	125	B82143-A1272-K	B82143-B1272-K
3,3		1,0	50	7,96	1450	0,14	115	B82143-A1332-K	B82143-B1332-K
3,9		1,0	50	7,96	1400	0,15	105	B82143-A1392-K	B82143-B1392-K
4,7		1,0	50	7,96	1300	0,17	60	B82143-A1472-K	B82143-B1472-K
5,6		1,0	50	7,96	1250	0,19	45	B82143-A1562-K	B82143-B1562-K
6,8		1,0	40	7,96	1200	0,22	35	B82143-A1682-K	B82143-B1682-K
8,2		1,0	40	7,96	1150	0,24	25	B82143-A1822-K	B82143-B1822-K
10		1,0	40	7,96	1100	0,25	21	B82143-A1103-K	B82143-B1103-K
12		0,10	35	2,52	1050	0,27	17	B82143-A1123-K	B82143-B1123-K
15		0,10	35	2,52	1000	0,30	16	B82143-A1153-K	B82143-B1153-K
18		0,10	35	2,52	950	0,33	15	B82143-A1183-K	B82143-B1183-K
22		0,10	35	2,52	900	0,37	13	B82143-A1223-K	B82143-B1223-K
27		0,10	35	2,52	850	0,42	11	B82143-A1273-K	B82143-B1273-K

HF-Drosseln RF Chokes

Bedrahtet / Leaded
Large-Bobbin-Core

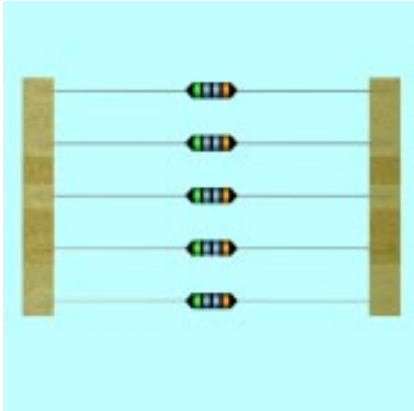

Baureihe LBC

- Großer Rollenkern aus Ferrit

Maße (mm) $\varnothing \times l$: 5,2 × 12
IEC-Klimakategorie 55/125/56
Lieferform axial gegurtet
Rastermaß min. 15 mm

Baureihe HLBC

- LBC-Drossel mit höherem Nennstrom

Maße (mm) $\varnothing \times l$: 6,5 × 12

LBC series

- Large ferrite bobbin core

Dimensions (mm) $\varnothing \times l$: 5,2 × 12
IEC climatic category 55/125/56
Delivery mode axially taped
Lead spacing min. 15 mm

HLBC series

- LBC choke with higher rated current

Dimensions (mm) $\varnothing \times l$: 6,5 × 12

L_N L_R μH	Toleranz Tolerance	f_L MHz	Q_{\min}	f_Q MHz	I_N I_R mA	R_{\max} Ω	$f_{\text{res, min}}$ MHz	Bestellnummer Ordering code
---------------------------------	-----------------------	--------------	------------	--------------	----------------------	------------------------	------------------------------	--------------------------------

Baureihe LBC

LBC series

1,0	±10% ≐K	1,0	40	7,96	2200	0,08	200	B82144-A2102-K
1,5		1,0	40	7,96	2100	0,09	190	B82144-A2152-K
2,2		1,0	40	7,96	1900	0,11	140	B82144-A2222-K
3,3		1,0	40	7,96	1750	0,13	120	B82144-A2332-K
4,7		1,0	40	7,96	1600	0,16	100	B82144-A2472-K
6,8		1,0	40	7,96	1500	0,19	80	B82144-A2682-K
10		1,0	60	2,52	1400	0,22	60	B82144-A2103-K
15		0,10	60	2,52	1250	0,28	20	B82144-A2153-K
22		0,10	50	2,52	1100	0,35	12	B82144-A2223-K
33		±5% ≐J	0,10	40	2,52	900	0,43	8,0
47	0,10		40	2,52	800	0,50	5,0	B82144-A2473-J
68	0,10		30	2,52	700	0,60	4,5	B82144-A2683-J
100	0,10		50	0,796	600	0,70	3,5	B82144-A2104-J
150	0,10		50	0,796	500	0,90	3,0	B82144-A2154-J
220	0,10		50	0,796	400	1,60	2,4	B82144-A2224-J
330	0,10		50	0,796	330	1,90	2,0	B82144-A2334-J
470	0,10		40	0,796	280	2,50	1,5	B82144-A2474-J
680	0,10		30	0,796	240	2,80	1,3	B82144-A2684-J
1000	0,10		60	0,252	200	3,80	1,2	B82144-A2105-J
1500	0,10		60	0,252	160	6,00	1,0	B82144-A2155-J
2200	0,10		60	0,252	120	9,00	0,8	B82144-A2225-J
3300	0,10		60	0,252	110	12,0	0,6	B82144-A2335-J
4700	0,10		60	0,252	90	20,0	0,5	B82144-A2475-J
6800	0,010		60	0,252	80	30,0	0,4	B82144-A2685-J
10000	0,010		50	0,0796	60	42,0	0,35	B82144-A2106-J
15000	0,010		50	0,0796	50	68,0	0,30	B82144-A2156-J
22000	0,010		50	0,0796	40	120	0,26	B82144-A2226-J
33000	0,010		50	0,0796	35	150	0,22	B82144-A2336-J
47000	0,010		40	0,0796	30	230	0,18	B82144-A2476-J
68000	0,010	40	0,0796	25	290	0,15	B82144-A2686-J	
100000	0,010	40	0,0796	20	360	0,12	B82144-A2107-J	

HF-Drosseln

RF Chokes

Bedrahtet / Leaded
Large-Bobbin-Core

L_N L_R μH	Toleranz Tolerance	f_L MHz	Q_{\min}	f_Q MHz	I_N I_R mA	R_{\max} Ω	$f_{\text{res, min}}$ MHz	Bestellnummer Ordering code
---------------------------------	-----------------------	--------------	------------	--------------	----------------------	------------------------	------------------------------	--------------------------------

Baureihe HLBC (LBC-Drossel mit höherem Nennstrom)

HLBC series (LBC choke with higher rated current)

100	$\pm 5\%$	0,10	50	0,796	860	0,70	3,5	B82145-A1104-J
150	$\approx J$	0,10	40	0,796	770	0,90	3,0	B82145-A1154-J
220		0,10	30	0,796	690	1,10	2,5	B82145-A1224-J
330		0,10	30	0,796	630	1,30	2,1	B82145-A1334-J
470		0,10	30	0,796	510	1,90	1,8	B82145-A1474-J
680		0,10	20	0,796	440	2,50	1,5	B82145-A1684-J
1000		0,10	60	0,252	370	3,60	1,3	B82145-A1105-J
1500		0,10	60	0,252	300	5,40	1,0	B82145-A1155-J
2200		0,10	60	0,252	250	8,00	0,8	B82145-A1225-J
3300		0,10	60	0,252	200	12,5	0,6	B82145-A1335-J
4700		0,10	60	0,252	170	18,0	0,5	B82145-A1475-J
6800		0,010	60	0,252	130	28,5	0,4	B82145-A1685-J
10000		0,010	50	0,0796	110	35,0	0,35	B82145-A1106-J

HF-Drosseln RF Chokes

UKW-Drosseln VHF chokes

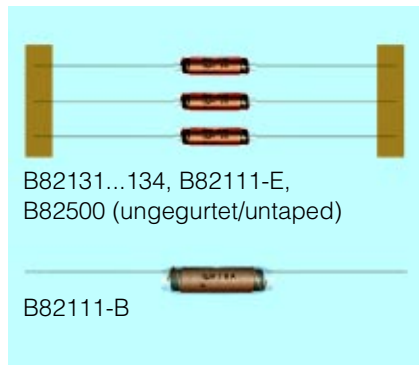

- Breitbandige Entstörung
- Karbonyleisen- oder Ferritkern

Nennspannung 250 V- \sqrt{V} ~
500 V- \sqrt{V} ~
L-Toleranz $\pm 20\%$
IEC-Klimakategorie 55/125/56
Prüfzeichen 
(für U_N 500 V-)

- Broadband RFI suppression
- Carbonyl iron or ferrite core

Rated voltage 250 Vdc/Vac
500 Vdc/Vac
L tolerance $\pm 20\%$
IEC climatic category 55/125/56
Approvals 
(for U_R 500 Vdc)

I_N I_R A	$L_N^{(1)}$ $L_R^{(1)}$ μH	R_{typ} Ω	f_{res} MHz	Maße Dimensions $\varnothing \times l$ (mm)	Min. Rastermaß Min. lead spacing mm	Kern Core	Bestellnummer Ordering code
Nennspannung 250 V-\sqrt{V}~ Rated voltage 250 Vdc/Vac							
0,2	3900	20	1,8	10,0 × 32	–	Ferrit	B82500-C-A2
0,5	820	2,5	3,0	10,0 × 32	–	Ferrite	B82500-C-A5
1,0	330	0,6	4,2	10,0 × 32	–		B82500-C-A8
2,0	120	0,15	5,8	10,0 × 32	–		B82500-C-A10
Nennspannung 500 V-\sqrt{V}~ Rated voltage 500 Vdc/Vac							
0,10	1200	34	16	6,0 × 26	30	Ferrit/Ferrite	B82111-E-C29
0,15	80	11	22	5,0 × 14	17,5	Karbonyleisen Carbonyl iron	B82131-A5151-M
	160	17	20	5,5 × 19	22,5		B82132-A5151-M
	350	21	11	7,5 × 24	27,5		B82133-A5151-M
	420	19	12	7,5 × 29	32,5		B82134-A5151-M
0,2	680	14	19	6,0 × 26	30	Ferrit/Ferrite	B82111-E-C28
0,3	40	4,1	31	5,0 × 14	17,5	Karbonyleisen Carbonyl iron	B82131-A5301-M
	70	5,7	29	5,5 × 19	22,5		B82132-A5301-M
	160	6,5	16	7,5 × 24	27,5		B82133-A5301-M
	210	6,4	18	7,5 × 29	32,5		B82134-A5301-M
	470	6,5	25	6,0 × 26	30	Ferrit/Ferrite	B82111-E-C27
0,4	27	2,0	40	5,0 × 14	17,5	Karbonyleisen Carbonyl iron	B82131-A5401-M
	50	3,0	37	5,5 × 19	22,5		B82132-A5401-M
	130	4,8	18	7,5 × 24	27,5		B82133-A5401-M
	150	3,5	18	7,5 × 29	32,5		B82134-A5401-M
0,5	220	2,6	32	6,5 × 26	30	Ferrit/Ferrite	B82111-E-C26
0,7	14	0,76	53	5,0 × 14	17,5	Karbonyleisen Carbonyl iron	B82131-A5701-M
	23	0,73	55	5,5 × 19	22,5		B82132-A5701-M
	55	1,2	26	7,5 × 24	27,5		B82133-A5701-M
	60	0,77	34	7,5 × 29	32,5		B82134-A5701-M
1,0	100	0,65	55	6,5 × 26	30	Ferrit/Ferrite	B82111-E-C25
1,5	6	0,19	84	5,0 × 14	17,5	Karbonyleisen Carbonyl iron	B82131-A5152-M
	8	0,16	90	5,5 × 19	22,5		B82132-A5152-M
	25	0,32	40	7,5 × 24	27,5		B82133-A5152-M
	30	0,30	44	7,5 × 29	32,5		B82134-A5152-M
	56	0,30	70	6,5 × 26	30	Ferrit/Ferrite	B82111-E-C24
2	3	0,09	113	5,0 × 14	17,5	Karbonyleisen Carbonyl iron	B82131-A5202-M
	6	0,11	108	5,5 × 19	22,5		B82132-A5202-M
	14	0,13	57	7,5 × 24	27,5		B82133-A5202-M
	20	0,15	59	7,5 × 29	32,5		B82134-A5202-M

HF-Drosseln RF Chokes

UKW-Drosseln VHF chokes

I_N I_R A	$L_N^{(1)}$ $L_R^{(1)}$ μH	R_{typ} Ω	f_{res} MHz	Maße Dimensions $\varnothing \times l$ (mm)	Min. Rastermaß Min. lead spacing mm	Kern Core	Bestellnummer Ordering code
Nennspannung 500 V-$V\sim$ Rated voltage 500 Vdc/Vac							
2	17	0,063	100	7,0 × 24	–	Ferrit Ferrite	B82111-B-C14
	40	0,180	90	7,0 × 26	30		B82111-E-C23
3	2	0,038	147	5,0 × 14	17,5	Karbonyleisen Carbonyl iron	B82131-A5302-M
	3	0,035	151	5,5 × 19	22,5		B82132-A5302-M
	10	0,077	69	7,5 × 24	27,5		B82133-A5302-M
	12	0,090	75	7,5 × 29	32,5		B82134-A5302-M
	8	0,025	145	7,0 × 24	–	Ferrit Ferrite	B82111-B-C13
	13	0,024	170	6,5 × 29	–		B82111-B-C19
	20	0,054	125	6,0 × 29	–		B82111-B-C20
	22	0,070	110	7,0 × 26	30		B82111-E-C22
25	0,046	85	8,5 × 34	–	B82111-B-C24		
4	1	0,014	199	5,0 × 14	17,5	Karbonyleisen Carbonyl iron	B82131-A5402-M
	2	0,020	186	5,5 × 19	22,5		B82132-A5402-M
	5	0,034	87	7,5 × 24	27,5		B82133-A5402-M
	7	0,033	94	7,5 × 29	32,5		B82134-A5402-M
	6	0,017	170	7,5 × 24	–	Ferrit Ferrite	B82111-B-C12
	11	0,020	150	6,5 × 29	–		B82111-B-C18
	12	0,040	140	7,5 × 26	30		B82111-E-C21
	15	0,024	120	8,5 × 34	–		B82111-B-C23
6	1	0,010	243	5,5 × 19	22,5	Karbonyleisen Carbonyl iron	B82132-A5602-M
	3	0,019	108	7,5 × 24	27,5		B82133-A5602-M
	4	0,014	205	7,5 × 24	–	Ferrit Ferrite	B82111-B-C11
	6	0,010	200	7,0 × 29	–		B82111-B-C17
	7	0,020	180	7,5 × 26	30		B82111-E-C20
	9	0,012	150	9,0 × 34	–		B82111-B-C22
9	3	0,006	220	7,5 × 29	–	Ferrit/Ferrite	B82111-B-C16
10	5	0,005	175	9,5 × 34	–	Ferrit/Ferrite	B82111-B-C21

1) Meßfrequenz/Measuring frequency:
 $L \leq 10 \mu\text{H}$ = 1 MHz
 $10 \mu\text{H} < L \leq 1000 \mu\text{H}$ = 100 kHz
 $L > 1000 \mu\text{H}$ = 10 kHz

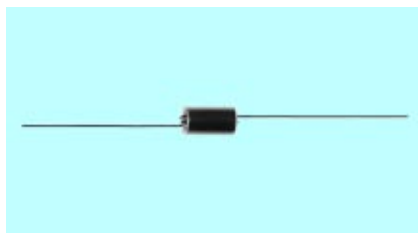

■ Breitbandige Entstörung
 ■ Runder Sechschloch-Ferritkern

■ Broadband RFI suppression
 ■ Round 6-aperture ferrite core

Nennstrom 1 A
 Nennspannung 500 V- $V\sim$

Rated current 1 A
 Rated voltage 500 Vdc/Vac

f_{res}	Z bei/at f_{res} Ω	Kennfarbe Color code	Windungszahl Number of turns	Maße Dimensions $\varnothing \times l$ (mm)	IEC-Klimakat. IEC climatic category	Isolation Insulation	Bestellnummer Ordering code
60	900	braun/brown	2,5	6,2 × 15	55/120/21	nein / no	B82114-R-A4
60	900	braun/brown	2,5	6,2 × 15	55/125/56	ja / yes	B82114-R-C4
100	800	grün/green	2,5	6,7 × 15	55/120/21	nein / no	B82114-R-A1
100	800	grün/green	2,5	6,7 × 15	55/125/56	ja / yes	B82114-R-C1

Drosseln für Signal- und Datenleitungen

Chokes for Signal and Data Lines



SMD-Bauformen

- Stromkompensierte SMD-Drosseln
- Kernmaterial: Ferrit-Ringkern

Nennspannung	42 V~/80 V-
L-Toleranz	±30%
IEC-Klimakategorie	40/125/56
Lötbarkeit	IR-/Vapor-Phase
Lieferform: Blistergurt	16 bzw. 24 mm

SMD types

- Current-compensated SMD chokes
- Core material: ferrite ring core

Rated voltage	42 Vac/80 Vdc
L tolerance	±30%
IEC climatic category	40/125/56
Solderability	IR/vapor phase
Deliv. mode: Blister tape	16 or 24 mm

L_N L_R mH	L_S , typ μ H	I_N I_R A	R_{typ} m Ω	Maße Dimensions $l \times b \times h$ (mm)	An- schlüsse Terminals	Anwendungen Applications	Bestellnummer Ordering code
----------------------	------------------------	---------------------	-------------------------	--	------------------------------	-----------------------------	--------------------------------

Zweifach-Drosseln / Double chokes

0,011	0,050	0,5	120	7,1 × 6,0 × 5,2	4	CAN-Bus	B82790-C0113-N201
0,025	1,5	0,5	200	7,1 × 6,0 × 5,2	4	CAN-Bus	B82790-S0253-N201
0,051	2,0	0,5	300	7,1 × 6,0 × 5,2	4	CAN-Bus	B82790-S0513-N201
0,470	0,20	0,5	250	7,1 × 6,0 × 5,2	4	Telecom	B82790-C0474-N215
1,0	0,20	0,5	200	7,1 × 6,0 × 5,2	4	Telecom	B82790-C0105-N240
4,7	0,25	0,2	550	7,1 × 6,0 × 5,2	4	Telecom	B82790-C0475-N265
4,7	0,25	0,5	400	11,5 × 10,5 × 7,3	8	Telecom	B82790-C0475-N340
6,8	0,30	0,5	500	11,5 × 10,5 × 7,3	8	Telecom	B82790-C0685-N340
10	0,40	0,2	1100	11,5 × 10,5 × 7,3	8	Telecom	B82790-C0106-N340

Vierfach-Drosseln / Quad chokes

0,47	0,15	0,5	250	11,5 × 10,5 × 7,3	8	ISDN/Telecom	B82790-C2474-N315
1,0	0,20	0,5	250	11,5 × 10,5 × 7,3	8	ISDN/Telecom	B82790-C2105-N340
4,7	0,30	0,2	800	11,5 × 10,5 × 7,3	8	ISDN/Telecom	B82790-C2475-N340

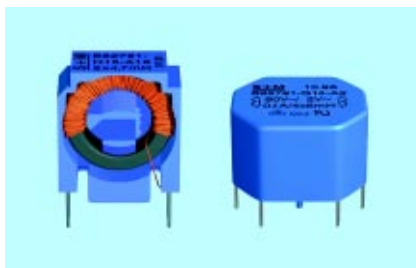

Bedrahtete Bauformen

- Stromkompensierte Drosseln
- Kernmaterial: Ferrit-Ringkern
- Kunststoffbecher (UL 94 V-0)

Nennspannung	42 V~/80 V-
L-Toleranz	±30% ¹⁾
IEC-Klimakategorie	40/125/56

Leaded types

- Current-compensated chokes
- Core material: ferrite ring core
- Plastic case (UL 94 V-0)

Rated voltage	42 Vac/80 Vdc
L tolerance	±30% ¹⁾
IEC climatic cat.	40/125/56

L_N L_R mH	L_S , max μ H	I_N I_R A	R_{typ} Ω	Maße Dimensions $l \times b \times h$ (mm)	Anwendungen Applications	Bestellnummer Ordering code Legend/Horizontal Stehend/Vertical
----------------------	------------------------	---------------------	-----------------------	--	-----------------------------	--

Zweifach-Drosseln / Double chokes

2,2	1,0	0,1	0,4	17,7 × 17,7 × 8	Telecom	B82791-G15-A17
4,7	1,5	0,1	0,9	15,2 × 7,4 × 17,6	Telecom	B82791-H15-A16
4,7	1,5	0,1	0,9	17,7 × 17,7 × 8	Telecom	B82791-G15-A16
10	2,5	0,1	1,3	15,2 × 7,4 × 17,6	Telecom	B82791-H15-A25
38	3,5	0,1	3,3	17,7 × 17,7 × 8	Telecom	B82791-G15-A14

Vierfach-Drosseln / Quad chokes

0,2	1,5	0,1	0,18	17,7 × 17,7 × 8	ISDN	B82791-G14-A17	-
4,7	2,5	0,1	0,90	17,7 × 17,7 × 8	ISDN	B82791-G14-A16	-
6	3	0,1	0,92	17,7 × 17,7 × 8	ISDN	B82791-G14-A12	-

1) B82791-G15-A16 und/and B82791-H15-A16: +35/-25%

Drosseln für Netzanwendungen

Chokes for Power Lines

Stabkerndrosseln, vergossen

I core chokes with encapsulation

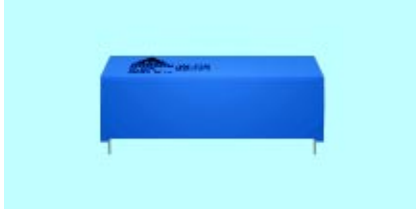

- Kunststoffgehäuse, vergossen (UL 94 V-0)
- Kernmaterial: FeSi-Blech

- Plastic case, potted (UL 94 V-0)
- Core material: laminated iron-silicon

Nennspannung 500 V~/600 V-
 L-Toleranz ±20%
 IEC-Klimakategorie 40/125/56

Rated voltage 500 Vac/600 Vdc
 L tolerance ±20%
 IEC climatic category 40/125/56

Bauform Type	I_N I_R A	L_N L_R mH	R_{typ} mΩ	Maße Dimensions $l \times b \times h$ (mm)	Anschluß Terminal	Bestellnummer Ordering code
B82502	0,2	82	45000	50 × 22,5 × 12,5	Stifte im Rastermaß	B82502-W-C2
	0,5	15	8500	50 × 22,5 × 12,5	Pins fitting standard	B82502-W-C5
	1	3,3	1900	50 × 22,5 × 12,5	PCB grid	B82502-W-C8
	2	0,68	55	50 × 22,5 × 12,5		B82502-W-C10

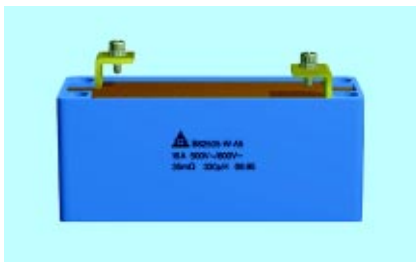

- Kunststoffgehäuse, vergossen (UL 94 V-0)
- Kernmaterial: FeSi-Blech

- Plastic case, potted (UL 94 V-0)
- Core material: laminated iron-silicon

Nennspannung 500 V~/600 V-
 L-Toleranz ±20%
 IEC-Klimakategorie 40/125/56

Rated voltage 500 Vac/600 Vdc
 L tolerance ±20%
 IEC climatic category 40/125/56

Bauform Type	I_N I_R A	L_N L_R mH	R_{typ} mΩ	Maße Dimensions $l \times b \times h$ (mm)	Anschluß Terminal	Bestellnummer Ordering code
B82504	1	27	5250	78,0 × 28 × 32	Klemmbügel (M4) Clamps (M4)	B82504-W-A1
	2	7,5	1300	78,0 × 28 × 32		B82504-W-A2
	4	2,0	330	78,0 × 28 × 32		B82504-W-A3
	6	0,6	150	78,0 × 28 × 32		B82504-W-A4
	10	0,2	54	78,0 × 28 × 32		B82504-W-A5
	16	0,14	24	78,0 × 28 × 32	Federscheibe (M4) Spring washers (M4)	B82504-W-A6
	25	0,065	9	78,0 × 28 × 32	B82504-W-A7	
B82505	4	5,6	480	111,0 × 40 × 43	Schraub- anschlüsse M5 Screw terminals M5	B82505-W-A2
	6	2,2	220	111,0 × 40 × 43		B82505-W-A3
	10	1,2	75	111,0 × 40 × 43		B82505-W-A4
	16	0,33	35	111,0 × 40 × 43		B82505-W-A5
	25	0,15	15	111,0 × 40 × 43		B82505-W-A6
	40	0,056	6	111,0 × 40 × 43		B82505-W-A7
B82506	6	5,0	350	142,5 × 49 × 50	Schraub- anschlüsse M6 Screw terminals M6	B82506-W-A3
	10	2,5	125	142,5 × 49 × 50		B82506-W-A4
	16	1,5	50	142,5 × 49 × 50		B82506-W-A5
	25	0,5	20	142,5 × 49 × 50		B82506-W-A6
	40	0,2	8	142,5 × 49 × 50		B82506-W-A7
	60	0,08	4	142,5 × 49 × 50		B82506-W-A8

Drosseln für Netzanwendungen

Chokes for Power Lines

Stabkerndrosseln, unvergossen

I core chokes without encapsulation



■ Wicklung aus Kupferlackdraht

Nennspannung 400 V~/450 V-
L-Toleranz ±20%
IEC-Klimakategorie 40/125/56

■ Winding of enamel copper wire

Rated voltage 400 Vac/450 Vdc
L tolerance ±20%
IEC climatic category 40/125/56

Bauform Type	I_N I_R A	L_N L_R mH	R_{typ} mΩ	Maße Dimensions $l \times b \times h$ (mm)	Anschluß Terminal	Bestellnummer Ordering code
B82503	0,5	47	10000	58 × 23 × 25,5	Flachstecker Tab connectors	B82503-U-A5
	1	15	2700	58 × 23 × 25,5		B82503-U-A8
	2	3,3	700	58 × 23 × 25,5		B82503-U-A10
	4	0,68	200	58 × 23 × 25,5		B82503-U-A12
	6	0,33	100	58 × 23 × 25,5		B82503-U-A13
	10	0,1	30	58 × 23 × 25,5		B82503-U-A14



■ Hochkantwicklung aus
Flachkupferband

Nennspannung 500 V~/600 V-
L-Toleranz ±20%
IEC-Klimakategorie 40/110/21

■ Flat copper wire
wound on edge

Rated voltage 500 Vac/600 Vdc
L tolerance ±20%
IEC climatic category 40/110/21

Bauform Type	I_N I_R A	L_N L_R mH	R_{typ} mΩ	Maße Dimensions $l \times b \times h$ (mm)	Anschluß Terminal	Bestellnummer Ordering code
B82507	25	1,4	30	196 × 57,0 × 68,5	Schraub- anschlüsse M6 × 18 Screw terminals M6 × 18	B82507-B-A3
	35	0,55	16	196 × 57,0 × 68,5		B82507-B-A4
	60	0,2	7	196 × 57,0 × 68,5		B82507-B-A5
	75	0,08	2	196 × 57,0 × 68,5		B82507-B-B6
B82508	60	0,87	10	261 × 78,5 × 88	Schraub- anschlüsse M8 × 25 Screw terminals M8 × 25	B82508-B-A3
	75	0,30	4	261 × 78,5 × 88		B82508-B-B4
	160 A~/125 A~	0,08	1	261 × 78,5 × 88		B82508-B-B6
	270 A~/230 A~	0,03	0,4	261 × 78,5 × 88		B82508-B-B7



■ Wicklung aus Cu-Litze

Nennspannung 750 V~/900 V-
L-Toleranz ±20%
IEC-Klimakategorie 40/110/21

■ Winding of copper litz wire

Rated voltage 750 Vac/900 Vdc
L tolerance ±20%
IEC climatic category 40/110/21

Bauform Type	I_N I_R A	L_N L_R mH	R_{typ} mΩ	Maße Dimensions $l \times b \times h$ (mm)	Anschluß Terminal	Bestellnummer Ordering code
B82510	250 A~/200 A~	0,120	1	415 × 130 × 160	Schraub- anschlüsse M12 Screw terminals M12	B82510-A-B1
	350 A~/275 A~	0,070	0,5	415 × 130 × 160		B82510-A-B2
	700 A~/550 A~	0,016	0,15	415 × 130 × 160		B82510-A-B3

Drosseln für Netzanwendungen

Chokes for Power Lines

Ringkerndrosseln mit Pulverkern

Ring core chokes with powder core



- Kunststoffbecher, vollvergossen (UL 94 V-0)
- Stifte im Rastermaß

Nennspannung 250 V~/350 V-
 IEC-Klimakategorie 40/125/56
 Prüfzeichen 
 (für Bauformen B82623 und B82624)

- Plastic case, potted (UL 94 V-0)
- Pins fitting standard PCB grid

Rated voltage 250 Vac/350 Vdc
 IEC climatic category 40/125/56
 Approvals 
 (for types B82623 and B82624)

Bauform Type	Art Design	I_N I_R A	L_N L_R mH	L-Toleranz L tolerance	R_{typ} mΩ	Maße Dimensions $l \times b \times h$ (mm)	Bestellnummer Ordering code
B82623	Zweifach Double	0,3	1,20	± 20%	2100	27,0 × 28,0 × 16,8	B82623-G1-A3
		0,5	1,00	± 20%	1200	27,0 × 28,0 × 16,8	B82623-G1-A5
		1	0,330	± 20%	440	27,0 × 28,0 × 16,8	B82623-G1-A8
		2	0,082	± 20%	110	27,0 × 28,0 × 16,8	B82623-G1-A10
		3	0,033	± 20%	40	27,0 × 28,0 × 16,8	B82623-G1-A11
B82624	Zweifach Double	1	0,80	± 30%	1000	32,6 × 33,6 × 25	B82624-B2102-N1
		2	0,20	± 30%	250	32,6 × 33,6 × 25	B82624-B2202-N1
		3	0,10	± 30%	120	32,6 × 33,6 × 25	B82624-B2302-N1
		4	0,050	± 30%	60	32,6 × 33,6 × 25	B82624-B2402-N1
		5	0,040	± 30%	45	32,6 × 33,6 × 25	B82624-B2502-N1
		6	0,025	± 30%	35	32,6 × 33,6 × 25	B82624-B2602-N1

Oberschwingungsdrosseln zur Unterdrückung symmetrischer Störungen (harmonische Schwingungen)

Harmonic chokes for suppressing differential-mode interference (harmonic frequencies)

B82615	Einfach Single	1	20	± 20%	3000	42,4 × 44,0 × 30	B82615-B2102-M1
		2	5,0	± 20%	900	42,4 × 44,0 × 30	B82615-B2202-M1
		3	2,5	± 20%	400	42,4 × 44,0 × 30	B82615-B2302-M1
		4	1,5	± 20%	220	42,4 × 44,0 × 30	B82615-B2402-M1
		5	1,0	± 20%	150	42,4 × 44,0 × 30	B82615-B2502-M1
		6	0,7	± 20%	100	42,4 × 44,0 × 30	B82615-B2602-M1
B82617	Einfach Single	1	40	± 20%	3200	∅ × h = 63 × 39	B82617-F2102-M1
		2	18	± 20%	1200	∅ × h = 63 × 39	B82617-F2202-M1
		3	9,5	± 20%	700	∅ × h = 63 × 39	B82617-F2302-M1
		4	5,5	± 20%	410	∅ × h = 63 × 39	B82617-F2402-M1
		5	3,5	± 20%	280	∅ × h = 63 × 39	B82617-F2502-M1
		6	2,4	± 20%	185	∅ × h = 63 × 39	B82617-F2602-M1
		8	1,4	± 20%	100	∅ × h = 63 × 39	B82617-F2802-M1
		10	1,0	± 20%	65	∅ × h = 63 × 39	B82617-F2103-M1
B82625	Zweifach Single	1	5	± 20%	1400	42,4 × 44,0 × 30	B82625-B2102-M1
		2	1,2	± 20%	450	42,4 × 44,0 × 30	B82625-B2202-M1
		3	0,7	± 20%	200	42,4 × 44,0 × 30	B82625-B2302-M1
		4	0,4	± 20%	110	42,4 × 44,0 × 30	B82625-B2402-M1
		5	0,25	± 20%	75	42,4 × 44,0 × 30	B82625-B2502-M1
		6	0,18	± 20%	50	42,4 × 44,0 × 30	B82625-B2602-M1
B82627	Zweifach Double	1	10,0	± 20%	2000	∅ × h = 63 × 39	B82627-F2102-M1
		2	4,5	± 20%	650	∅ × h = 63 × 39	B82627-F2202-M1
		3	2,5	± 20%	380	∅ × h = 63 × 39	B82627-F2302-M1
		4	1,5	± 20%	200	∅ × h = 63 × 39	B82627-F2402-M1
		5	0,9	± 20%	140	∅ × h = 63 × 39	B82627-F2502-M1
		6	0,6	± 20%	90	∅ × h = 63 × 39	B82627-F2602-M1
		8	0,35	± 20%	50	∅ × h = 63 × 39	B82627-F2802-M1
		10	0,25	± 20%	35	∅ × h = 63 × 39	B82627-F2103-M1

Drosseln für Netzanwendungen

Chokes for Power Lines

Stromkompensierte Ringkerndrosseln

Current-compensated ring core chokes



Zweifach-Drosseln

- Kunststoffbecher, vergossen (UL 94 V-0)¹⁾
- Stifte im Rastermaß

Nennspannung 250 V~
 L-Toleranz ±30%²⁾
 IEC-Klimakategorie 40/125/56
 Prüfzeichen

Double chokes

- Plastic case, potted (UL 94 V-0)¹⁾
- Pins fitting standard PCB grid

Rated voltage 250 Vac
 L tolerance ±30%²⁾
 IEC climatic category 40/125/56
 Approvals

Bauform Type	I_N I_R A	L_N L_R mH	L_S , typ μ H	R_{typ} m Ω	Maße Dimensions $l \times b \times h$ mm	Bestellnummer / Ordering code	
						Liegend Horizontal version	Stehend Vertical version
B82721	0,4	39	450	2000	17,3 × 17,9 × 12,6 (liegend/horizontal)	B82721-A2401-N20	B82721-K2401-N20
	0,4	27	270	1700		B82721-A2401-N21	B82721-K2401-N21
	0,5	18	260	1500	18,2 × 13,2 × 20,3 (stehend/vertical)	B82721-A2501-N1	B82721-K2501-N1
	0,7	10	90	600		B82721-A2701-N20	B82721-K2701-N20
	1,2	6,8	70	280		B82721-A2122-N20	B82721-K2122-N20
	1,5	3,3	37	190		B82721-A2152-N1	B82721-K2152-N1
	2,0	1,0	13	90		B82721-A2202-N1	B82721-K2202-N1
	2,6	0,4	6	60		B82721-A2262-N1	B82721-K2262-N1
3,6	0,4	6	35	B82721-A2362-N1	B82721-K2362-N1		
B82722	0,3	47	760	2500	22,3 × 22,7 × 13,3 (liegend/horizontal)	B82722-A2301-N1	B82722-J2301-N1
	0,5	27	430	1200		B82722-A2501-N1	B82722-J2501-N1
	1	10	140	480	23,3 × 16,1 × 25,4 (stehend/vertical)	B82722-A2102-N1	B82722-J2102-N1
	2	2,2	30	130		B82722-A2202-N1	B82722-J2202-N1
	3	1,2	17	56		B82722-A2302-N1	B82722-J2302-N1
B82723	0,5	56	870	2200	27,0 × 28,0 × 16,8 (liegend/horizontal)	B82723-A2501-N1	B82723-J2501-N1
	1	27	440	750		B82723-A2102-N1	B82723-J2102-N1
	2	5,6	80	160	28,0 × 18,6 × 30,5 (stehend/vertical)	B82723-A2202-N1	B82723-J2202-N1
	4	2,7	30	60		B82723-A2402-N1	B82723-J2402-N1
B82724-A/J	0,5	82	1000	2700	32,6 × 33,1 × 19,7 (liegend/horizontal)	B82724-A2501-N1	B82724-J2501-N1
	1	33	420	810		B82724-A2102-N1	B82724-J2102-N1
	1,4	27	310	500	31,3 × 18,5 × 33,2 (stehend/vertical)	B82724-A2142-N1	B82724-J2142-N1
	2	6,8	80	190		B82724-A2202-N1	B82724-J2202-N1
	4	3,3	40	66		B82724-A2402-N1	B82724-J2402-N1
B82724-E Öko-Drossel Eco choke	0,5	82	950	2100	33,1 × 32,6 × 19,7 (liegend/horizontal)	B82724-E2501-N1	
	1	33	400	650		B82724-E2102-N1	
	1,4	27	280	370		B82724-E2142-N1	
	2	6,8	75	190		B82724-E2202-N1	
	4	3,3	35	55		B82724-E2402-N1	
B82724-B	1	47	550	880	33,6 × 32,6 × 25 (liegend/horizontal)	B82724-B2102-N1	
	2	10	110	230		B82724-B2202-N1	
	4	3,9	40	58		B82724-B2402-N1	
	6	1,8	16	23		B82724-B2602-N1	
B82725	1	68	900	1300	42,4 × 44,0 × 25 (liegend/horizontal)	B82725-A2102-N1	
	2	18	230	350		B82725-A2202-N1	
	4	6,8	80	87		B82725-A2402-N1	
	6	3,9	45	41		B82725-A2602-N1	
	8	2,7	30	22		B82725-A2802-N1	
	10	1,8	20	14		B82725-A2103-N1	

1) Ausgenommen Öko-Drossel B82724-E / Except eco choke B82724-E

2) Öko-Drossel: -30/+50% / Eco choke: -30/+50%

Drosseln für Netzanwendungen

Chokes for Power Lines

Stromkompensierte Ringkerndrosseln

Current-compensated ring core chokes



Dreifach-Drosseln

- Kunststoffbecher (B82747)
- Aluminiumbecher (B82745)
- Vergossen (UL 94 V-0)

Nennspannung 440/250 V~
 L-Toleranz ±30%
 IEC-Klimakategorie 40/125/56
 Prüfzeichen (für 6 ... 16 A)

Triple chokes

- Plastic case (B82747)
- Aluminum case (B82745)
- Potted (UL 94 V-0)

Rated voltage 440/250 Vac
 L tolerance ±30%
 IEC climatic category 40/125/56
 Approvals (for 6 ... 16 A)

Bauform Type	I_N I_R A	L_N L_R mH	R_{typ} mΩ	Maße Dimensions $l \times b \times h$ (mm)	Anschluß Terminal	Bestellnummer Ordering code
B82747	6	6,0	50	$\varnothing \times h = 73 \times 39$	Verzinnete Drähte Tinned leads	B82747-F4602-N1
	10	3,0	20	$\varnothing \times h = 73 \times 39$		B82747-F4103-N1
	16	2,0	12	$\varnothing \times h = 73 \times 39$		B82747-F4163-N1
	25	1,3	7,5	$\varnothing \times h = 73 \times 39$		B82747-F4253-N20
B82745	50	1,3	3,75	142,0 × 122,0 × 65	Litzen 4,2 mm ² / Litz wires 4,2 mm ²	B82745-C5-A7
	100	0,33	0,65	212,5 × 146,5 × 121	Bolzenklemme M10 / Stud terminal M10	B82745-C2-A10
	200	0,12	0,28	212,5 × 146,5 × 121	Bolzenklemme M8 / Stud terminal M8	B82745-C2-A13



Vierfach-Drosseln

- Aluminiumbecher
- Vergossen (UL 94 V-0)

Nennspannung 440/250 V~
 L-Toleranz ±30%
 IEC-Klimakategorie 40/125/56

Quad chokes

- Aluminum case
- Potted (UL 94 V-0)

Rated voltage 440/250 Vac
 L tolerance ±30%
 IEC climatic category 40/125/56

Bauform Type	I_N I_R A	L_N L_R mH	R_{typ} mΩ	Maße Dimensions $l \times b \times h$ (mm)	Anschluß Terminal	Bestellnummer Ordering code
B82765	16	1,8	20	75 × 75,0 × 47	Verzinnete Drähte / Tinned leads Litzen 4,2 mm ² / Litz wires 4,2 mm ² Litzen 11,5 mm ² / Litz wires 11,5 mm ² Litzen 16,7 mm ² / Litz wires 16,7 mm ²	B82765-C1-A5
	25	1,3	7	75 × 75,0 × 58		B82765-C2-A6
	50	1,3	3,75	142 × 122,0 × 70		B82765-C5-A7
	75	0,9	2,5	175 × 146,5 × 112		B82765-C6-A11

Drosseln für Netzanwendungen

Chokes for Power Lines



D-Kern-Drosseln (Öko-Drosseln)

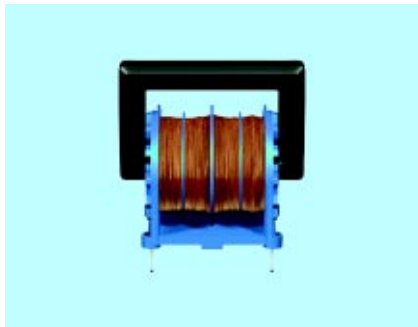

D core chokes (eco chokes)



- Stromkompensierte Zweifach-Drosseln mit geschlossenem Rechteck-Ferritkern
- Spulenkörper (UL 94 V-0)
- Anschlußstifte im Rastermaß

- Current-compensated double chokes with closed, rectangular ferrite core
- Coil former (UL 94 V-0)
- Pins fitting standard PCB grid

Nennspannung 250 V~
 L-Toleranz -30%/+50%
 IEC-Klimakategorie 40/125/56
 Prüfzeichen (eingereicht)  

Rated voltage 250 Vac
 L tolerance -30%/+50%
 IEC climatic category 40/125/56
 Approvals (pending)  

Bauform Type	I_N I_R A	L_N L_R mH	L_S mH	R_{typ} mΩ	Maße Dimensions $l \times b \times h$ (mm)	Bestellnummer Ordering code
B82731	0,4	47	420	2400	20,5 × 15,0 × 20,0	B82731-R2401-A30
	0,4	39	350	2150		B82731-R2401-A31
	0,5	27	245	1450		B82731-R2501-A30
	0,8	15	130	730		B82731-R2801-A30
	0,9	10	90	510		B82731-R2901-A30
	1,2	6,8	60	350		B82731-R2122-A30
	1,5	3,3	30	200		B82731-R2152-A30
B82732	0,6	47	400	1400	24,0 × 16,5 × 23,0	B82732-R2601-A30
	0,7	39	330	1100		B82732-R2701-A30
	0,9	27	230	750		B82732-R2901-A30
	1,1	15	125	440		B82732-R2112-A30
	1,4	10	85	300		B82732-R2142-A30
	1,7	6,8	55	190		B82732-R2172-A30
	2,2	3,3	27	110		B82732-R2222-A30
B82734	1,3	47	250	560	32,5 × 21,0 × 31,0	B82734-R2132-A30
	1,4	39	210	460		B82734-R2142-A30
	1,7	27	140	320		B82734-R2172-A30
	2,3	15	80	185		B82734-R2232-A30
	2,6	10	53	130		B82734-R2262-A30
	3,2	6,8	35	85		B82734-R2322-A30
	4,6	3,3	17	46		B82734-R2462-A30

Filter Filters

Übersicht Selector guide

Bauform Type	Nennstrom (A) Rated current (A)	Anzahl der Leiter Number of lines	Anschlüsse Terminals								Einfügungsdämpfung im Frequenzbereich (Hz) Insertion loss in frequency range (Hz)			Seite Page	
			Flachstecker Tab connect.	Printmontage Pins	IEC-Stecker IEC connect.	Litzen Litz wires	Klemmen Terminal blocks	Bolzen Studs	Laschen Lugs	10 ⁵	10 ⁶	10 ⁷			
Filter für allgemeine Anwendungen General-purpose filters															
B84111-A... B84115-E	1 ... 20	2	●			●									34
B84111-A-K... B84115-E-K	1 ... 6	2			●										34
B84112-B-P30	3	2		●											34
B84110-A	0,5 ... 6	2		●											36
B84110-B	1,4	2		●											36
B84103	1 ... 6	2	●		●										36
Filter für Anlagen und Systeme Filters for installations and systems															
B84299-K6*	2 ... 36	2				●									37
B84299-K2*	10 ... 25	2					●								37
B84299-K5*	6 ... 50	3 + N					●								38
B84299-K3*	6 ... 75	3 + N					●								38
B84131	6 ... 125	3 + N	●					●							39
B84108	10 ... 20	3 + N	●												39
B84134-F	12	3 + N	●												40
B84134-A, B84134-B	25 ... 50	3 + N						●							40
Filter für Umrichter und Leistungselektronik Filters for converters and power electronics															
B84142 (440 V)	8 ... 25	2					●								41
B84143-A (440 V)	8 ... 1600	3					●		●						41
B84143-B (440 V)	8 ... 80	3					●								42
B84144 (440 V)	16 ... 1600	3 + N					●		●						42
B84143-B (500 V)	250 ... 2500	3							●						43
B84143-A (760 V)	25 ... 180	3					●								43
B84143-B (760 V)	250 ... 2500	3							●						43
B84143-B (690 V) (IT-Netz/IT mains supply)	250 ... 2500	3							●						43
Filter für Anlagen und geschirmte Räume Filters for installations and shielded rooms															
B84312 (Communications lines, ISDN)	0,1 ... 1	2 ... 4					●								44
B84299 (Netz / Power lines)	16 ... 100	2 ... 4						●							46
B84261/B84263	10 ... 200	2 ... 4						●							47

Filter für allgemeine Anwendungen

General-Purpose Filters

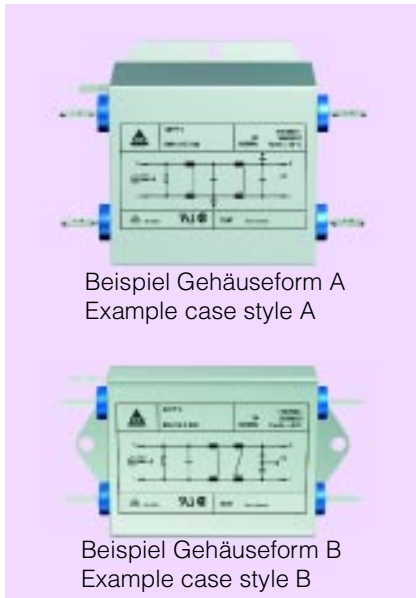

Baureihe SIFI

- Zwei-Leiter-Filter
- Aluminiumgehäuse
- Vergossen (UL 94 V-0)
- Alle relevanten Prüfzeichen

Anschluß-Varianten (Gehäuseformen):

- A: Beidseitig Flachstecker, Befestigungslaschen längsseitig
- B: Beidseitig Flachstecker, Befestigungslaschen stirnseitig
- K: Netzseitig IEC-Stecker, lastseitig Flachstecker
- L: Beidseitig Litzenanschlüsse
- P: Anschlußstifte im Rastermaß

Nennspannung 250 V~, 50/60 Hz
IEC-Klimakategorie 25/085/21



SIFI series

- Two-line filters
- Aluminum case
- Potted (UL 94 V-0)
- All relevant approvals

Terminal styles (case styles):

- A: Tab connectors on face ends, lateral mounting tabs
- B: Tab connectors on face ends, mounting tabs on face ends
- K: IEC connector on line side, tab connector on load side
- L: Litz wires on face ends
- P: Pins fitting standard PCB grid

Rated voltage 250 Vac, 50/60 Hz
IEC climatic category 25/085/21

I_N I_R A	C_N C_R	L_N L_R	I_{Ab1} I_{leak} mA	Ge- häu- se Case	Maße Dimensions $l \times b \times h$ (mm)	Bestellnummer Ordering code	Approbationen Approvals  EN 133 221  
---------------------	----------------	----------------	-------------------------------	---------------------------	--	--------------------------------	--

SIFI A für normale Dämpfung / SIFI A for normal attenuation



1	2 × 0,1 µF (X2) +	2 × 1,5 mH	< 0,5	A	50,0 × 45,0 × 22,3	B84111-A-A10	x	x	x
			< 0,5	K	63,5 × 51,0 × 32,0	B84111-A-K10	x	x	x
2	2 × 4700 pF (Y2)		< 0,5	A	50,0 × 45,0 × 22,3	B84111-A-A20	x	x	x
			< 0,5	L	50,0 × 45,0 × 28,6	B84111-A-L20	x	x	x
3	2 × 0,1 µF (X2) +	2 × 1,5 mH	< 0,5	A	50,0 × 45,0 × 22,3	B84111-A-A30	x	x	x
			< 0,5	K	63,5 × 51,0 × 32,0	B84111-A-K30	x	x	x
			< 0,5	L	50,0 × 45,0 × 28,6	B84111-A-L30	x	x	x
6	2 × 0,1 µF (X2) +	2 × 1,8 mH	< 0,5	A	50,0 × 45,0 × 28,6	B84111-A-A60	x	x	x
			< 0,5	B	50,0 × 45,0 × 28,6	B84111-A-B60	x	x	x
			< 0,5	K	63,5 × 51,0 × 32,0	B84111-A-K60	x	x	x
			< 0,5	L	50,0 × 45,0 × 28,6	B84111-A-L60	x	x	x
10	2 × 0,1 µF (X2) +	2 × 820 µH	< 0,5	A	50,0 × 45,0 × 28,6	B84111-A-A110	x	x	x
			< 0,5	B	50,0 × 45,0 × 28,6	B84111-A-B110	x	x	x
			< 0,5	L	50,0 × 45,0 × 28,6	B84111-A-L110	x	x	x
20	2 × 0,1 µF (X2) + 2 × 4700 pF (Y2)	2 × 470 µH	< 0,5	A	50,8 × 63,5 × 38,1	B84111-A-A120	x	x	x
			< 0,5	B	50,8 × 63,5 × 38,1	B84111-A-B120	x	x	x

SIFI B für erhöhte Dämpfung / SIFI B for enhanced attenuation

1	2 × 0,15 µF (X2) +	2 × 10 mH	< 0,5	A	50,0 × 45,0 × 28,6	B84112-B-A10	x	x	x
			< 0,5	B	50,0 × 45,0 × 28,6	B84112-B-B10	x	x	x
			< 0,5	K	63,5 × 51,0 × 32,0	B84112-B-K10	x	x	x
			< 0,5	L	50,0 × 45,0 × 28,6	B84112-B-L10	x	x	x
2	2 × 0,15 µF (X2) +	2 × 10 mH	< 0,5	A	50,0 × 45,0 × 28,6	B84112-B-A20	x	x	x
			< 0,5	B	50,0 × 45,0 × 28,6	B84112-B-B20	x	x	x
			< 0,5	L	50,0 × 45,0 × 28,6	B84112-B-L20	x	x	x
3	2 × 0,22 µF (X2) +	2 × 10 mH	< 0,5	A	63,5 × 50,8 × 28,6	B84112-B-A30	x	x	x
			< 0,5	B	63,5 × 50,8 × 28,6	B84112-B-B30	x	x	x
			< 0,5	K	79,5 × 50,8 × 32,0	B84112-B-K30	x	x	x
			< 0,5	L	63,5 × 50,8 × 28,6	B84112-B-L30	x	x	x
			< 0,5	P	63,4 × 50,8 × 28,6	B84112-B-P30	x	x	x

Filter für allgemeine Anwendungen

General-Purpose Filters

I_N I_R A	C_N C_R	L_N L_R	I_{Abl} I_{leak} mA	Ge- häuse Case	Maße Dimensions $l \times b \times h$ (mm)	Bestellnummer Ordering code	Approbationen Approvals   		
---------------------	----------------	----------------	-------------------------------	----------------------	--	--------------------------------	---	--	--

SIFI B (Fortsetzung) / SIFI B (continued)

6	2 × 0,33 µF (X2) + 2 × 4700 pF (Y2)	2 × 3,3 mH	< 0,5	A	63,5 × 50,8 × 28,6	B84112-B-A60	x	x	x
			< 0,5	B	63,5 × 50,8 × 28,6	B84112-B-B60	x	x	x
			< 0,5	K	79,5 × 50,8 × 32,0	B84112-B-K60	x	x	x
			< 0,5	L	63,5 × 50,8 × 28,6	B84112-B-L60	x	x	x
10	2 × 0,47 µF (X2) + 2 × 4700 pF (Y2)	2 × 1,8 mH	< 0,5	A	63,5 × 50,8 × 38,1	B84112-B-A110	x	x	x
			< 0,5	B	63,5 × 50,8 × 38,1	B84112-B-B110	x	x	x
			< 0,5	L	63,5 × 50,8 × 38,1	B84112-B-L110	x	x	x
20	2 × 0,68 µF (X2) + 2 × 4700 pF (Y2)	2 × 1,8 mH	< 0,5	A	99,0 × 84,0 × 38,1	B84112-B-A120	x	x	x
			< 0,5	B	99,0 × 84,0 × 38,1	B84112-B-B120	x	x	x

SIFI C für sehr hohe Dämpfung / SIFI C for very high attenuation

3	2 × 0,47 µF (X2) + 2 × 4700 pF (Y2)	4 × 4,7 mH	< 0,5	A	63,5 × 50,8 × 38,1	B84113-C-A30	x	x	x
			< 0,5	B	63,5 × 50,8 × 38,1	B84113-C-B30	x	x	x
			< 0,5	K	63,5 × 50,8 × 38,0	B84113-C-K30	x	x	x
			< 0,5	L	63,5 × 50,8 × 38,1	B84113-C-L30	x	x	x
6	2 × 0,47 µF (X2) + 2 × 4700 pF (Y2)	4 × 4,7 mH	< 0,5	A	133,0 × 50,8 × 44,5	B84113-C-A60	x	x	x
			< 0,5	B	133,0 × 50,8 × 44,5	B84113-C-B60	x	x	x
			< 0,5	L	133,0 × 50,8 × 44,5	B84113-C-L60	x	x	x
10	2 × 0,47 µF (X2) + 2 × 4700 pF (Y2)	4 × 3,6 mH	< 0,5	A	133,0 × 50,8 × 44,5	B84113-C-A110	x	x	x
			< 0,5	B	133,0 × 50,8 × 44,5	B84113-C-B110	x	x	x
			< 0,5	L	133,0 × 50,8 × 44,5	B84113-C-L110	x	x	x

SIFI D für hohe Dämpfung / SIFI D for high attenuation

1	2 × 0,47 µF (X2) + 2 × 4700 pF (Y2)	2 × 5,6 mH	< 0,5	A	63,5 × 50,8 × 28,6	B84114-D-A10	x	x	x
			< 0,5	B	63,5 × 50,8 × 28,6	B84114-D-B10	x	x	x
			< 0,5	K	79,5 × 50,8 × 32,0	B84114-D-K10	x	x	x
			< 0,5	L	63,5 × 50,8 × 28,6	B84114-D-L10	x	x	x
2	2 × 0,47 µF (X2) + 2 × 4700 pF (Y2)	2 × 5,6 mH	< 0,5	A	63,5 × 50,8 × 28,6	B84114-D-A20	x	x	x
			< 0,5	B	63,5 × 50,8 × 28,6	B84114-D-B20	x	x	x
			< 0,5	L	63,5 × 50,8 × 28,6	B84114-D-L20	x	x	x
3	2 × 0,47 µF (X2) + 2 × 4700 pF (Y2)	2 × 5,6 mH	< 0,5	A	63,5 × 50,8 × 28,6	B84114-D-A30	x	x	x
			< 0,5	B	63,5 × 50,8 × 28,6	B84114-D-B30	x	x	x
			< 0,5	K	79,5 × 50,8 × 32,0	B84114-D-K30	x	x	x
			< 0,5	L	63,5 × 50,8 × 28,6	B84114-D-L30	x	x	x
6	2 × 0,47 µF (X2) + 2 × 4700 pF (Y2)	2 × 4,7 mH	< 0,5	A	75,5 × 50,8 × 31,8	B84114-D-A60	x	x	x
			< 0,5	B	75,5 × 50,8 × 31,8	B84114-D-B60	x	x	x
			< 0,5	K	92,5 × 50,8 × 32,0	B84114-D-K60	x	x	x
			< 0,5	L	75,5 × 50,8 × 31,8	B84114-D-L60	x	x	x
10	2 × 0,68 µF (X2) + 2 × 4700 pF (Y2)	2 × 4,7 mH	< 0,5	A	92,0 × 50,8 × 44,5	B84114-D-A110	x	x	x
			< 0,5	B	92,0 × 50,8 × 44,5	B84114-D-B110	x	x	x
			< 0,5	L	92,0 × 50,8 × 44,5	B84114-D-L110	x	x	x

SIFI E für sehr hohe Dämpfung auch im Bereich unter 100 kHz / SIFI E for very high attenuation, even below 100 kHz

3	0,47 µF (X2) + 2 × 4700 pF (Y2)	2 × 270 µH	< 0,5	A	63,5 × 50,8 × 38,1	B84115-E-A30	x	x	x
		2 × 16 mH	< 0,5	B	63,5 × 50,8 × 38,1	B84115-E-B30	x	x	x
			< 0,5	K	79,5 × 50,8 × 38,0	B84115-E-K30	x	x	x
6	0,47 µF (X2) + 2 × 22 nF (Y2)	2 × 100 µH	< 3,5	A	133,0 × 50,8 × 44,5	B84115-E-A60	x	x	x
		2 × 4,7 mH	< 3,5	B	133,0 × 50,8 × 44,5	B84115-E-B60	x	x	x
			< 3,5	K	133,0 × 50,8 × 44,5	B84115-E-K60	x	x	x
10	0,47 µF (X2) + 2 × 22 nF (Y2)	2 × 47 µH + 2 × 3,6 mH	< 3,5	A	133,0 × 50,8 × 44,5	B84115-E-A110	x	x	x
		< 3,5	B	133,0 × 50,8 × 44,5	B84115-E-B110	x	x	x	

Filter für allgemeine Anwendungen

General-Purpose Filters



Filter für Leiterplattenbestückung

- Netzfilter für Einphasen-Systeme
- Kunststoffgehäuse
- Vergossen (UL 94 V-0)

Nennspannung 250 V~, 50/60 Hz
IEC-Klimakategorie 25/085/21

Filters for PCB mounting

- Power line filters for single-phase systems
- Plastic case
- Potted (UL 94 V-0)

Rated voltage 250 Vac, 50/60 Hz
IEC climatic category 25/085/21

I_N I_R A	C_N C_R	L_N L_R	I_{Abl} I_{leak} mA	Maße Dimensions $l \times b \times h$ (mm)	Bestellnummer Ordering code	Approbationen Approvals		
0,5	0,25 μ F (X2)	2 x 39 mH	< 0,5	56 x 30 x 23	B84110-A-A5	x	x	x
1	+	2 x 10 mH	< 0,5	56 x 30 x 23	B84110-A-A10	x	x	x
2	2 x 4700 pF (Y2)	2 x 5,6 mH	< 0,5	56 x 30 x 23	B84110-A-A20	x	x	x
4		2 x 2,7 mH	< 0,5	56 x 30 x 23	B84110-A-A40	x	x	x
6		2 x 1,9 mH	< 0,5	56 x 30 x 23	B84110-A-A60			



Filter für Leiterplattenbestückung

- Netzfilter für Einphasen-Systeme
- Kunststoffgehäuse
- Vergossen (UL 94 V-0)

Nennspannung 250 V~, 50/60 Hz
IEC-Klimakategorie 25/085/21

Filter for PCB mounting

- Power line filter for single-phase systems
- Plastic case
- Potted (UL 94 V-0)

Rated voltage 250 Vac, 50/60 Hz
IEC climatic category 25/085/21

I_N I_R A	C_N C_R	L_N L_R	I_{Abl} I_{leak} mA	Maße Dimensions $l \times b \times h$ (mm)	Bestellnummer Ordering code	Approbationen Approvals		
1,4	2 x 0,15 μ F (X2)	2 x 27 mH	< 0,5	34 x 31 x 33	B84110-B-A14	x	x	



Kompakfilter mit IEC-Stecker

- Netzfilter für Einphasen-Systeme
- Filter mit IEC-Stecker, Sicherungshalter und Schalter

Nennspannung 250 V~, 50/60 Hz
IEC-Klimakategorie 25/085/21

Compact filters, IEC connector

- Power line filters for single-phase systems
- Filters with IEC connector, fuse holder and switch

Rated voltage 250 Vac, 50/60 Hz
IEC climatic category 25/085/21

I_N I_R A	C_N C_R	L_N L_R	I_{Abl} I_{leak} mA	Maße Dimensions $l \times b \times h$ (mm)	Bestellnummer Ordering code	Approbationen Approvals		
1	0,33 μ F (X2)	2 x 9 mH + 2 x 270 μ H	< 1,0	50 x 28,5 x 60	B84103-S1-A10	x	x	x
3	+	2 x 1,5 mH + 2 x 22 μ H	< 1,0	50 x 28,5 x 60	B84103-S1-A30	x		x
6	2 x 10 nF (Y2)	2 x 0,47 mH + 2 x 8 μ H	< 1,0	50 x 28,5 x 60	B84103-S1-A60	x		x

Filter für Anlagen und Systeme

Filters for Installations and Systems



Filter mit LF-Entstörung

- Netzfilter für Einphasen-Systeme mit zusätzlicher LF-Entstörung
- Zwei-Leiter-Filter
- Metallgehäuse
- Vergossen (UL 94 V-0)
- Litzenschlüsse

Nennspannung 250 V~, 50/60 Hz
IEC-Klimakategorie 25/085/21

Filters with LF suppression

- Power line filters for single-phase systems with add. LF suppression
- Two-line filters
- Metal case
- Potted (UL 94 V-0)
- Litz wires

Rated voltage 250 Vac, 50/60 Hz
IEC climatic category 25/085/21

I_N I_R A	R_{typ} mΩ	I_{Abl} I_{leak} mA	Maße Dimensions $l \times b \times h$ (mm)	Bestellnummer Ordering code	Approbationen Approvals		
2	530	< 3,5	65,0 × 45,0 × 51	B84299-K61-C	x		
4	150	< 3,5	75,0 × 45,0 × 51	B84299-K62-C	x		
6	110	< 3,5	85,0 × 67,5 × 50	B84299-K63		x	
10	50	< 3,5	100,5 × 67,0 × 55	B84299-K64-C		x	
16	35	< 3,5	132,0 × 68,0 × 70	B84299-K65			
25	27	< 3,5	183,0 × 84,0 × 67	B84299-K66			
36	12	> 3,5	183,0 × 84,0 × 67	B84299-K67			



Filter mit VHF-Entstörung

- Netzfilter für Einphasen-Systeme mit zusätzlicher VHF-Entstörung
- Zwei-Leiter-Filter
- Metallgehäuse
- Berührungssichere Anschlußklemmen

Nennspannung 250 V~, 50/60 Hz
IEC-Klimakategorie 25/085/21

Filters with VHF suppression

- Power line filters for single-phase systems with add. VHF suppression
- Two-line filters
- Metal case
- Safe-to-touch terminal blocks

Rated voltage 250 Vac, 50/60 Hz
IEC climatic category 25/085/21

I_N I_R A	I_{Abl} I_{leak} mA	Maße Dimensions $l \times b \times h$ (mm)	Bestellnummer Ordering code	Approbationen Approvals		
10	< 3,5	162 × 89 × 51	B84299-K21-E	x	x	x
25	< 3,5	218 × 106 × 75	B84299-K26			

Filter für Anlagen und Systeme

Filters for Installations and Systems

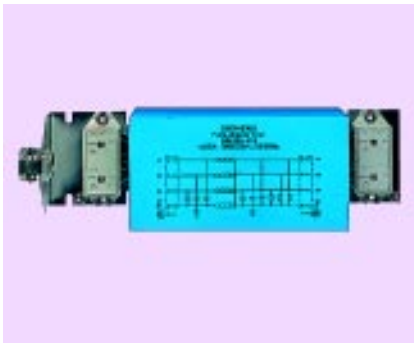

Hohe Einfügungsdämpfung

- Netzfilter für Dreiphasen-Systeme
- Vier-Leiter-Filter im Kunststoff- bzw. Metallgehäuse
- Vergossen (UL 94 V-0)
- Berührungssichere Anschlußklemmen

Nennspannung 440/250 V~,
50/60 Hz
IEC-Klimakategorie 25/085/21

High insertion loss

- Power line filters for three-phase systems
- Four-line filters in plastic case or metal case
- Potted (UL 94 V-0)
- Safe-to-touch terminal blocks

Rated voltage 440/250 Vac,
50/60 Hz
IEC climatic category 25/085/21

I_N I_R A	I_{Abl} I_{leak} mA	Maße Dimensions $l \times b \times h$ (mm)	Bestellnummer Ordering code	Approbationen Approvals		
6	< 3,5	249 × 73 × 50	B84299-K53	x		
16	< 3,5	249 × 73 × 67	B84299-K55	x		
25	< 3,5	249 × 73 × 67	B84299-K56	x	x	x
50	< 3,5	232 × 211 × 111	B84299-K57-D			



Filter mit VHF-Entstörung

- Netzfilter für Dreiphasen-Systeme mit zusätzlicher VHF-Entstörung
- Vier-Leiter-Filter im Metallgehäuse
- Berührungssichere Anschlußklemmen

Nennspannung 440/250 V~,
50/60 Hz
IEC-Klimakategorie 40/085/21

Filters with VHF suppression

- Power line filters for three-phase systems with add. VHF suppression
- Four-line filters in metal case
- Safe-to-touch terminal blocks

Rated voltage 440/250 Vac,
50/60 Hz
IEC climatic category 40/085/21

I_N I_R A	I_{Abl} I_{leak} mA	Maße Dimensions $l \times b \times h$ (mm)	Bestellnummer Ordering code	Approbationen Approvals
6	< 5	218 × 106 × 75	B84299-K33	x
16	< 5	218 × 106 × 90	B84299-K35	x (für/for 14 A)
25	< 5	236 × 130 × 102	B84299-K36	x (für/for 20 A)
50	< 5	300 × 207 × 95	B84299-K37	x (für/for 40 A)
75	< 10	350 × 207 × 140	B84299-K39	x (für/for 65 A)

Filter für Anlagen und Systeme

Filters for Installations and Systems

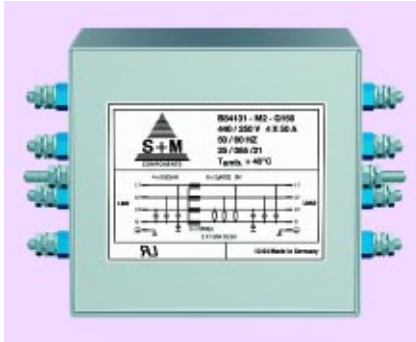

Hohe Einfügungsdämpfung

- Netzfilter für Dreiphasen-Systeme
- Vier-Leiter-Filter im Metallgehäuse
- Vergossen (UL 94 V-0)
- Flachstecker- bzw. Schraubanschlüsse

Nennspannung 440/250 V~,
50/60 Hz
IEC-Klimakategorie 25/085/21

High insertion loss

- Power line filters for three-phase systems
- Four-line filters in metal case
- Potted (UL 94 V-0)
- Tab connectors or screw terminals

Rated voltage 440/250 Vac,
50/60 Hz
IEC climatic category 25/085/21

I_N I_R A	I_{Abl} I_{leak} mA	Maße Dimensions $l \times b \times h$ (mm)	Anschlüsse Terminals	Bestellnummer Ordering code	Approbationen Approvals		
6	< 3,5	135 × 62 × 46	Flachstecker Tab connectors	B84131-A6-A1			
16	< 3,5	149 × 104 × 50	Flachstecker Tab connectors	B84131-M3-A116	x	x	x
35	< 3,5	149 × 104 × 80	Gewinde M6 Thread M6	B84131-M1-G135	x	x	x
35	< 3,5	149 × 104 × 80	Gewinde 10-32 UNF Thread 10-32 UNF	B84131-M1-H135	x	x	x
50	< 3,5	141 × 131 × 122	Gewinde M6 Thread M6	B84131-M2-G150		x	x
63	< 3,5	141 × 131 × 122	Gewinde M6 Thread M6	B84131-M2-G163		x	x
80	< 3,5	220 × 150 × 150	Gewinde M10 Thread M10	B84131-M4-G180			
125	< 3,5	220 × 150 × 150	Gewinde M10 Thread M10	B84131-M4-G225			

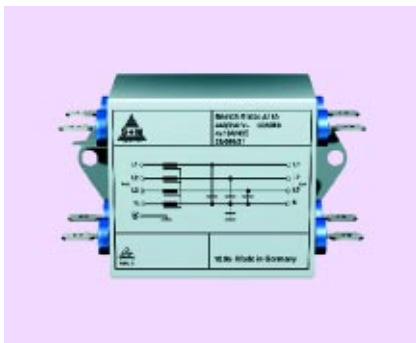

Mittlere Einfügungsdämpfung

- Netzfilter für Dreiphasen-Systeme
- Vier-Leiter-Filter im Aluminiumgehäuse
- Vergossen (UL 94 V-0)
- Flachsteckeranschlüsse

Nennspannung 440/250 V~,
50/60 Hz
IEC-Klimakategorie 25/085/21

Medium insertion loss

- Power line filters for three-phase systems
- Four-line filters in aluminum case
- Potted (UL 94 V-0)
- Tab connectors

Rated voltage 440/250 Vac,
50/60 Hz
IEC climatic category 25/085/21

I_N I_R A	I_{Abl} I_{leak} mA	Maße Dimensions $l \times b \times h$ (mm)	Bestellnummer Ordering code	Approbationen Approvals
10	< 3,5	63,5 × 50,8 × 38	B84108-S1004-A110	x
20	< 3,5	63,5 × 50,8 × 38	B84108-S1004-A120	

Filter für Anlagen und Systeme

Filters for Installations and Systems



Filter mit LF Entstörung



- Netzfilter für Dreiphasen-Systeme mit zusätzlicher LF-Entstörung
- Vier-Leiter-Filter im Metallgehäuse
- Flachsteckeranschlüsse

Nennspannung 440/250 V~,
50/60 Hz
IEC-Klimakategorie 25/085/21

Filter with LF suppression

- Power line filter for three-phase systems with add. LF suppression
- Four-line filter in metal case
- Tab connectors

Rated voltage 440/250 Vac,
50/60 Hz
IEC climatic category 25/085/21

I_N I_R A	R_{typ} mΩ	I_{Abl} I_{leak} mA	Maße Dimensions $l \times b \times h$ (mm)	Bestellnummer Ordering code	Approbationen Approvals
12	21	< 3,5	125 × 65 × 60	B84134-F12-A1	  
					x x x



Einfügungsdämpfung ≥ 100 dB im mittleren Frequenzbereich

- Netzfilter für Dreiphasen-Systeme
- Vier-Leiter-Filter im Metallgehäuse
- Schraubanschlüsse

Nennspannung 440/250 V~,
50/60 Hz
IEC-Klimakategorie 25/085/21

Insertion loss ≥ 100 dB in the medium frequency range

- Power line filters for three-phase systems
- Four-line filters in metal case
- Screw terminals

Rated voltage 440/250 Vac,
50/60 Hz
IEC climatic category 25/085/21

I_N I_R A	I_{Abl} I_{leak} mA	Maße Dimensions $l \times b \times h$ (mm)	Bestellnummer Ordering code	Approbationen Approvals
25	< 180	430 × 210 × 103	B84134-A25-G1	
50	< 1700	870 × 288 × 150	B84134-B50-G1	

Filter für Umrichter und Leistungselektronik

Filters for Converters and Power Electronics



Sehr hohe Einfügungsdämpfung

- Netzfilter für Einphasen-Systeme
- Zwei-Leiter-Filter
- Metallgehäuse

Nennspannung 250 V~, 50/60 Hz
IEC-Klimakategorie 25/085/21

Very high insertion loss

- Power line filters for single-phase systems
- Two-line filters
- Metal case

Rated voltage 250 Vac, 50/60 Hz
IEC climatic category 25/085/21

I_N I_R A	a_e symmetr. (150 kHz)	a_e asymmetr. (150 kHz)	I_{Abl} I_{leak} mA	R_{typ} m Ω	Maße Dimensions $l \times b \times h$ (mm)	Anschluß Terminal	Bestellnummer Ordering code
8	≥ 85 dB	≥ 70 dB	< 3,5	42	121 × 86 × 61	Berührungssichere	B84142-B8-R
12	≥ 85 dB	≥ 70 dB	< 3,5	30	121 × 86 × 61	Reihenklammern	B84142-B12-R
16	≥ 85 dB	≥ 64 dB	< 3,5	21	121 × 86 × 61	Safe-to-touch	B84142-B16-R
25	≥ 85 dB	≥ 64 dB	< 3,5	9	156 × 86 × 81	terminal blocks	B84142-B25-R



Hohe Einfügungsdämpfung

- Netzfilter für Dreiphasen-Systeme
- Drei-Leiter-Filter
- Metallgehäuse

Nennspannung 440/250 V~,
50/60 Hz
IEC-Klimakategorie 25/085/21

High insertion loss

- Power line filters for three-phase systems
- Three-line filters
- Metal case

Rated voltage 440/250 Vac,
50/60 Hz
IEC climatic category 25/085/21

I_N I_R A	a_e symmetr. (150 kHz)	a_e asymmetr. (150 kHz)	I_{Abl} I_{leak} mA	R_{typ} m Ω	Maße Dimensions $l \times b \times h$ (mm)	Anschluß Terminal	Bestellnummer Ordering code	
8	≥ 60 dB	≥ 50 dB	< 3,5	40	141 × 86 × 81	Berührungssichere Reihenklammern Safe-to-touch terminal blocks	B84143-A8-R	
12	≥ 57 dB	≥ 47 dB	< 3,5	20	141 × 86 × 81		B84143-A12-R	
16	≥ 53 dB	≥ 42 dB	< 3,5	15	141 × 86 × 81		B84143-A16-R	
25	≥ 62 dB	≥ 47 dB	< 3,5	8	166 × 126 × 91		B84143-A25-R	
36	≥ 44 dB	≥ 50 dB	< 3,5	2,5	166 × 126 × 91		B84143-A36-R	
50	≥ 50 dB	≥ 47 dB	< 6	2	166 × 126 × 91		B84143-A50-R	
80	≥ 56 dB	≥ 52 dB	< 6	1	221 × 141 × 141		B84143-A80-R	
120	≥ 38 dB	≥ 46 dB	< 6	0,75	261 × 141 × 141		B84143-A120-R	
150	≥ 38 dB	≥ 46 dB	< 6	0,4	261 × 141 × 141		B84143-A150-R	
180	≥ 38 dB	≥ 46 dB	< 6	0,4	301 × 141 × 141		B84143-A180-R	
250	≥ 55 dB	≥ 75 dB	< 6	0,095	350 × 230 × 171		Laschen	B84143-A250-S
500	≥ 55 dB	≥ 75 dB	< 6	0,060	500 × 250 × 158		Lugs	B84143-A500-S
1000	≥ 55 dB	≥ 75 dB	< 6	0,030	650 × 400 × 210			B84143-A1000-S
1600	≥ 55 dB	≥ 75 dB	< 6	0,020	680 × 400 × 210			B84143-A1600-S

Filter für Umrichter und Leistungselektronik

Filters for Converters and Power Electronics



Sehr hohe Einfügungsdämpfung

- Netzfilter für Dreiphasen-Systeme
- Drei-Leiter-Filter
- Metallgehäuse

Nennspannung 440/250 V~,
50/60 Hz
IEC-Klimakategorie 25/085/21

Very high insertion loss

- Power line filters for three-phase systems
- Three-line filters
- Metal case

Rated voltage 440/250 Vac,
50/60 Hz
IEC climatic category 25/085/21

I_N I_R A	a_e symmetr. (150 kHz)	a_e asymmetr. (150 kHz)	I_{Abl} I_{leak} mA	R_{typ} m Ω	Maße Dimensions $l \times b \times h$ (mm)	Anschluß Terminal	Bestellnummer Ordering code
8	≥ 85 dB	≥ 85 dB	$< 3,5$	80	171 × 126 × 81	Berührungssichere Reihenklammern Safe-to-touch terminal blocks	B84143-B8-R
12	≥ 80 dB	≥ 80 dB	$< 3,5$	40	171 × 126 × 81		B84143-B12-R
16	≥ 75 dB	≥ 80 dB	$< 3,5$	25	171 × 126 × 81		B84143-B16-R
25	≥ 85 dB	≥ 95 dB	$< 3,5$	10	231 × 126 × 91		B84143-B25-R
36	≥ 85 dB	≥ 80 dB	$< 3,5$	5	231 × 126 × 91		B84143-B36-R
50	≥ 70 dB	≥ 80 dB	< 6	3,5	231 × 126 × 91		B84143-B50-R
80	≥ 70 dB	≥ 80 dB	< 6	2	331 × 141 × 141		B84143-B80-R



Filter für USV-Anlagen

- Hohe Einfügungsdämpfung
- Netzfilter für Dreiphasen-Systeme
- Vier-Leiter-Filter
- Metallgehäuse

Nennspannung 440/250 V~,
50/60 Hz
IEC-Klimakategorie 25/085/21

Filters for UPS installations

- High insertion loss
- Power line filters for three-phase systems
- Four-line filters
- Metal case

Rated voltage 440/250 Vac,
50/60 Hz
IEC climatic category 25/085/21

I_N I_R A	a_e symmetr. (150 kHz)	a_e asymmetr. (150 kHz)	I_{Abl} I_{leak} mA	R_{typ} m Ω	Maße Dimensions $l \times b \times h$ (mm)	Anschluß Terminal	Bestellnummer Ordering code	
16	≥ 60 dB	≥ 60 dB	$< 3,5$	10	141 × 86 × 81	Berührungssichere Reihenklammern Safe-to-touch terminals	B84144-A16-R	
25	≥ 60 dB	≥ 60 dB	$< 3,5$	6	166 × 126 × 91		B84144-A25-R	
36	≥ 60 dB	≥ 60 dB	$< 3,5$	3,5	166 × 126 × 91		B84144-A36-R	
50	≥ 45 dB	≥ 40 dB	< 6	1,3	166 × 126 × 91		B84144-A50-R	
80	≥ 50 dB	≥ 50 dB	< 6	0,7	221 × 141 × 141		B84144-A80-R	
120	≥ 35 dB	≥ 35 dB	< 6	0,5	261 × 141 × 141		B84144-A120-R	
150	≥ 35 dB	≥ 35 dB	< 6	0,35	261 × 141 × 141		B84144-A150-R	
180	≥ 30 dB	≥ 33 dB	< 6	0,25	301 × 141 × 141		B84144-A180-R	
250	≥ 55 dB	≥ 75 dB	< 6	0,095	350 × 230 × 171		Laschen Lugs	B84144-G250-S
500	≥ 55 dB	≥ 75 dB	< 6	0,060	500 × 250 × 198			B84144-G500-S
1000	≥ 55 dB	≥ 75 dB	< 6	0,030	650 × 400 × 290	B84144-G1000-S		
1600	≥ 55 dB	≥ 75 dB	< 6	0,020	680 × 400 × 290	B84144-G1600-S		

Filter für Umrichter und Leistungselektronik

Filters for Converters and Power Electronics

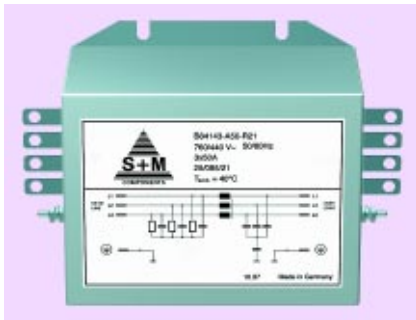

Hohe Einfügungsdämpfung Hohe Nennspannung

- Netzfilter für Dreiphasen-Systeme
- Drei-Leiter-Filter
- Metallgehäuse

Nennspannung 760/440 V~,
50/60 Hz
IEC-Klimakategorie 25/085/21

High insertion loss High rated voltage

- Power line filters for three-phase systems
- Three-line filters
- Metal case

Rated voltage 760/440 Vac,
50/60 Hz
IEC climatic category 25/085/21

I_N I_R A	a_e symmetr. (150 kHz)	a_e asymmetr. (150 kHz)	I_{Abl} I_{leak} mA	R_{typ} mΩ	Maße Dimensions $l \times b \times h$ (mm)	Anschluß Terminal	Bestellnummer Ordering code
25	≥ 50 dB	≥ 60 dB	< 7	8,0	166 × 126 × 91	Berührungssichere Reihenklammern Safe-to-touch terminal blocks	B84143-A25-R21
36	≥ 46 dB	≥ 48 dB	< 7	2,5	166 × 126 × 91		B84143-A36-R21
50	≥ 38 dB	≥ 50 dB	< 12	2,0	166 × 126 × 91		B84143-A50-R21
80	≥ 42 dB	≥ 56 dB	< 12	1,0	221 × 141 × 141		B84143-A80-R21
120	≥ 30 dB	≥ 50 dB	< 12	0,75	261 × 141 × 141		B84143-A120-R21
150	≥ 24 dB	≥ 50 dB	< 12	0,4	261 × 141 × 141		B84143-A150-R21
180	≥ 24 dB	≥ 46 dB	< 12	0,4	301 × 141 × 141		B84143-A180-R21

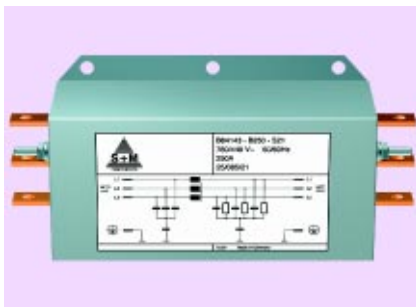

Hohe Einfügungsdämpfung Hohe Nennspannung

- Netzfilter für Dreiphasen-Systeme
- Drei-Leiter-Filter
- Metallgehäuse

Nennspannung siehe Tabelle unten
IEC-Klimakategorie 25/085/21

High insertion loss High rated voltage

- Power line filters for three-phase systems
- Three-line filters
- Metal case

Rated voltage see table below
IEC climatic category 25/085/21

U_N (V~) V_R (Vac) (50/60 Hz)	I_N I_R A	a_e symmetr. (150 kHz)	a_e asymmetr. (150 kHz)	I_{Abl} I_{leak} mA	R_{typ} mΩ	Maße Dimensions $l \times b \times h$ (mm)	Anschluß Terminal	Bestellnummer Ordering code
500/290 760/440	250	≥ 40 dB	≥ 80 dB	< 6	63	300 × 140 × 115	Laschen Lugs	B84143-B250-S**1)
	320	≥ 40 dB	≥ 80 dB	< 6	67	300 × 210 × 115		B84143-B320-S**1)
	400	≥ 40 dB	≥ 80 dB	< 6	63	300 × 210 × 115		B84143-B400-S**1)
	600	≥ 40 dB	≥ 80 dB	< 6	52	350 × 210 × 115		B84143-B600-S**1)
	1000	≥ 40 dB	≥ 80 dB	< 6	33	350 × 250 × 165		B84143-B1000-S**1)
	1600	≥ 40 dB	≥ 80 dB	< 6	22	400 × 250 × 165		B84143-B1600-S**1)
	2500	≥ 40 dB	≥ 80 dB	< 6	15	650 × 320 × 200		B84143-B2500-S**1)

Filter für IT-Netz-Anwendung / Filters for IT mains supply

690/400	250	≥ 40 dB	≥ 55 dB	< 6	63	300 × 140 × 115	Laschen Lugs	B84143-B250-S24
	320	≥ 40 dB	≥ 55 dB	< 6	67	300 × 210 × 115		B84143-B320-S24
	400	≥ 40 dB	≥ 55 dB	< 6	63	300 × 210 × 115		B84143-B400-S24
	600	≥ 40 dB	≥ 55 dB	< 6	52	350 × 210 × 115		B84143-B600-S24
	1000	≥ 40 dB	≥ 55 dB	< 6	33	350 × 250 × 165		B84143-B1000-S24
	1600	≥ 40 dB	≥ 55 dB	< 6	22	400 × 250 × 165		B84143-B1600-S24
	2500	≥ 40 dB	≥ 55 dB	< 6	15	650 × 320 × 200		B84143-B2500-S24

1) Anstelle ** ist die Kennzahl für die Ausführungsart einzusetzen: 20 = 500/290 V; 21 = 760/440 V
Replace the asterisks ** by the code number for the required version: 20 = 500/290 V; 21 = 760/440 V

Filter für Anlagen und geschirmte Räume

Filters for Installations and Shielded Rooms

Filter für ISDN-Leitungen

Filters for ISDN lines

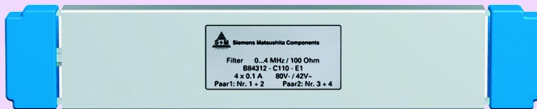

- 2-Leiter- und 4-Leiter-Filter
- Flache und stehende Montageart

Nennspannungen 80 V~/42 V~
250 V~/100 V~
IEC-Klimakategorie 40/085/56
Sperrdämpfung bis 40 GHz

- 2-line and 4-line filters
- Flat and upright mounting

Rated voltages 80 Vdc/42 Vac
250 Vdc/100 Vac
IEC climatic category 40/085/56
Stop band attenuation up to 40 GHz

Schnittstellenbezeichnung System	Standard	Transfer Rate	Durchlaßbandbreite ¹⁾ Bandwidth ¹⁾	Leitungsimpedanz Line impedance	Durchlaßband Pass band	Anpassung an Matched to	Empfohlenes Filter Bestellnummer Required filter Ordering code
		Schrittgeschwindigkeit Stepping rate					
S ₂ bzw./or PCM 30	CCITT	2,048 Mbit/s	5,12 MHz	120 Ω ± 10%	0 ... 10 MHz	50 Ω	B84312-C112-E1
	G.703	–					
S ₀ ISDN 2B+D	CCITT I.430	144 kbit/s	480 MHz	85 bis/to 160 Ω	0 ... 4 MHz	100 Ω	B84312-C110-E1
	ETS 300012	–					
U _{P0} ISDN 2B+D	ZVEI	304 kbit/s (152 kbit/s je Richtung/ each direction)	960 kHz	100 Ω	0 ... 4 MHz	100 Ω	B84312-C114-B1
		384 kBd					
U _{2B1Q} ISDN 2B+D	ANSI	160 kbit/s	200 kHz	135 Ω (nominal)	0 ... 300 kHz	150 Ω	B84312-+60-B1 ²⁾
	T1.601-1988	80 kBd					
U _{k0} ISDN 2B+D	FTZ 1	160 kbit/s je Richtung/ each direction	300 kHz	150 Ω	0 ... 300 kHz	150 Ω	B84312-+60-B1 ²⁾
	TR220	120 kBd					
U ₂₀₀ 1B+D	Siemens-spezif. HICOM- Schnittstelle Siemens-specific HICOM interface	160 kbit/s (80 kbit/s je Richtung/ each direction)	640 kHz	130 Ω	0 ... 4 MHz	100 Ω	B84312-C114-B1
		256 kBd					

Maße (mm) / Dimensions (mm)

Länge ³⁾ /Length ³⁾	Breite/Width	Höhe/Height
258	25	56

1) Min. Durchlaßbandbreite = $5 \times f_{\text{meß}}$ / Min. bandwidth = $5 \times f_{\text{meas}}$

2) Anstelle + ist der Kennbuchstabe für die gewünschte Montageart einzusetzen: C = stehende Montage, F = flache Montage
Replace the + by the code letter for mounting mode: C = upright mounting, F = flat mounting

3) Länge ohne Anschlußarmatur/Length without fittings

Filter für Anlagen und geschirmte Räume

Filters for Installations and Shielded Rooms

Filter für Kommunikationsleitungen

Filters for communications lines



- 2-Leiter- und 20-Leiter-Filter
- Flache und stehende Montageart

Nennspannung 250 V~/100 V~
IEC-Klimakategorie 40/085/56
Sperrdämpfung bis 40 GHz

- 2-line and 20-line filters
- Flat and upright mounting

Rated voltage 250 Vdc/100 Vac
IEC climatic category 40/085/56
Stop band attenuation up to 40 GHz

Durchlaßband Pass band kHz	Anpassung Matched an/to Ω	Anwendung Application	I_N I_R A	R_{DC} je Leitg. per line	Bestellnummer ¹⁾ Ordering code ¹⁾
0 ... 3,4	600	Telefonsysteme Telephone systems	0,1	11	B84312-+20-+3
0 ... 10	600	Telefonsysteme mit erweitertem Durchlaßbereich Telephone systems with extended pass band	0,1	4	B84312-+10-+3
0 ... 50	600	Telefonsysteme, Modemleitungen, bedingt geeignet für Steuerleitungen mit kritischer Flankensteilheit Telephone systems and modem cables, conditionally for control lines with critical signal rise times	0,1	1,1	B84312-+40-+1
–	–	Universalfilter für Steuer-/Schaltleitungen bis 1 A Universal filters for signal/control lines with up to 1 A	1	0,2	B84312-+30-+3
0 ... 120 0 ... 3,4	120 150	Datensignale mit symmetrischer Übertragungsart wie bei Modems oder Übertragungsschnittstelle RS 485 bzw. RS 422 (bis 9600 bzw. 19200 Baud) Data signals with balanced signal transmission mode as used by modems or RS 485 / RS 422 interfaces (up to 9,600 or 19,200 Baud)	0,1 0,1	4,4 1,6	B84312-+50-+1 B84312-+60-+1
0 ... 3,4	600	Telefonsysteme für erhöhte Anforderungen (Sperrdämpfung von 100 dB ab 10 kHz) Telephone systems for enhanced requirements (stop band attenuation of 100 dB above 10 kHz)	0,1	17	B84312-+90-+4
–	–	Steuerleitungen bis 1 A bei erhöhten Dämpfungsanforderungen Control lines with up to 1 A and enhanced attenuation requirements	1	0,6	B84312-+100-+3

Maße (mm) / Dimensions (mm)

	Länge ²⁾ Length	Breite Width	Höhe Height		Länge ²⁾ Length	Breite Width	Höhe Height
Ausführung C und F Version C and F	258	25	56	Ausführung H Version H	370	84	160

1) Anstelle + im 2. Block der Bestellnummer ist der Kennbuchstabe für die gewünschte Montageart einzusetzen: C = stehende Montage, F = flache Montage
Anstelle + im 3. Block der Bestellnummer ist der Kennbuchstabe für die Anzahl der gewünschten Leitungen einzusetzen: B = 2 Leitungen, H = 20 Leitungen
Replace the + in the 2nd block of the ordering code by the code letter for mounting mode: C = upright mounting, F = flat mounting
Replace the + in the 3rd block of the ordering code by the code letter for the number of lines: B = 2-line filter, H = 20-line filter

2) Länge ohne Anschlußarmatur / Length without fittings

Filter für Anlagen und geschirmte Räume

Filters for Installations and Shielded Rooms

Filter für Netzleitungen
Filters for power lines



Leistungsfilter für Einphasen- und Dreiphasensysteme

Prüfspannung 1100 V– 2 s
IEC-Klimakategorie 40/085/56
Nennfrequenz 50/60 Hz
Sperrdämpfung bis 40 GHz

High-performance filters for single-phase and three-phase systems

Test voltage 1100 Vac, 2s
IEC climatic category 40/085/56
Rated frequency 50/60 Hz
Stop band attenuation up to 40 GHz

I_N I_R A	Anzahl der Leitungen Number of lines	U_N V_R V	$a_e = 100 \text{ dB}/14 \text{ kHz}$ Bestellnummer ¹⁾ Ordering code ¹⁾	$a_e = 100 \text{ dB}/150 \text{ kHz}$ Bestellnummer ¹⁾ Ordering code ¹⁾
16	2	250	B84299-+1160-B3	B84299-+1160-B1
16	4	440/250	B84299-+1160-E3	B84299-+1160-E1
32	2	250	B84299-+1320-B3	B84299-+1320-B1
32	4	440/250	B84299-+1320-E3	B84299-+1320-E1
63	4	440/250	B84299-+1630-E3	B84299-+1630-E1
100	4	440/250	B84299-+1101-E3	B84299-+1101-E1

Maße (mm) / Dimensions (mm)

Bestellnummer Ordering code	Länge Length	Breite Width	Höhe Height	Bestellnummer Ordering code	Länge Length	Breite Width	Höhe Height
B84299-+1160-+3	1070	288	155	B84299-+1160-+1	850	288	155
B84299-+1320-+3	1070	288	155	B84299-+1320-+1	850	288	155
B84299-+1630-E3	1350	288	155	B84299-+1630-E1	1070	288	155
B84299-+1101-E3	1450	370	200	B84299-+1101-E1	1070	370	200

1) + = C: für Anschluß an die Schirmung über eine Anschlußarmatur
+ = D: Direktanschluß an die Schirmung über integrierten Flansch im Gehäuseboden
+ = C: for connection to shield by fitting
+ = D: for direct connection to shield by integrated flange on case bottom

Filter für Anlagen und geschirmte Räume

Filters for Installations and Shielded Rooms

Filter für Netzleitungen

Filters for power lines

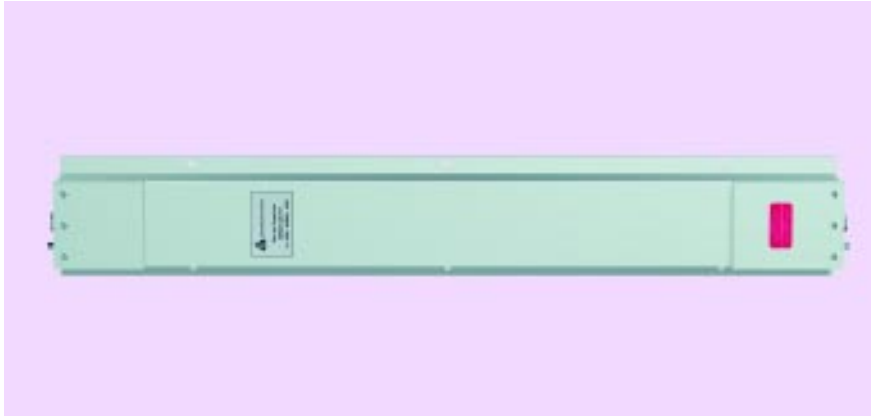

Ableitstromarme Filter

Prüfspannung	1100 V-, 2 s
IEC-Klimakategorie	40/085/56
Nennfrequenz	50/60 Hz
Sperrdämpfung	bis 40 GHz
Ableitstrom	< 2,5 mA/V

Low-leakage filters

Test voltage	1100 Vac, 2s
IEC climatic category	40/085/56
Rated frequency	50/60 Hz
Stop band attenuation	up to 40 GHz
Leakage current	< 2,5 mA/V

I_N I_R A	Anzahl der Leitungen Number of lines	U_N V_R V	$a_e = 100$ dB/14 kHz Bestellnummer ¹⁾ Ordering code ¹⁾	$a_e = 100$ dB/150 kHz Bestellnummer ¹⁾ Ordering code ¹⁾
10	2	250	B84263-A21-B13 B84263-C21-B13	
16	4	440/250	B84263-C22-E13	
40	2	250	B84263-A23-B13 B84263-C23-B13	B84261-A23-B11 B84261-C23-B11
40	4	440/250	B84263-A23-E13 B84263-C23-E13	B84261-C23-E11
100	4	440/250	B84263-A25-E13 B84263-C25-E13	B84261-A25-E11 B84261-C25-E11
200	4	440/250		B84261-C26-E11

Filter für 400-Hz-System 208/120 V einsetzbar.
 $I_{max} = 0,5 \cdot I_N$. Auf erhöhten Blindstrom/Ableitstrom achten!

Filters also suitable for 400-Hz system 208/120V.
 $I_{max} = 0,5 \cdot I_N$. Reactive/leakage current will increase!

Maße (mm) / Dimensions (mm)

Bestellnummer Ordering code	Länge Length	Breite Width	Höhe Height	Bestellnummer Ordering code	Länge Length	Breite Width	Höhe Height
B84261-+23-B11	590	174	103	B84263-+21-B13	590	174	103
B84261-C23-E11	1020	314	333	B84263-C22-E13	1200	288	150
B84261-+25-E11	1300	314	333	B84263-+23-B13	1128	174	103
B84261-C26-E11	1600	314	333	B84263-+23-E13	1600	314	333
				B84263-+25-E13	1750	314	333

1) Filter B8426*-A... zur Direktmontage an Schirmwand mit Einschweißflansch (Einschweißflansch B83208-A-Z808 nicht im Lieferumfang)
 Filter B8426*-C... beidseitig bestückt mit Kabelverschraubungen bzw. HF-dichtem Anschluß an Schirmwand mit flexibler Anschlußarmatur
 Filter B8426*-A... for direct mounting on shielded wall by welding flange (welding flange B83208-A-Z808 not included in delivery)
 Filter B8426*-C... with screw-type cable glands on both sides or for RF-tight connection to shielded wall by flexible fitting

Durchführungsfilter

Feed-through Filters

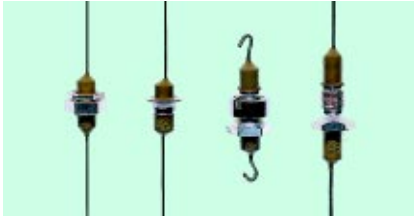

Filter für niedrige Ströme

- Kostengünstige Entstör-
lösung
- Keramik-Technologie

IEC-Klimakategorie 40/085/21

Low-current filters

- Cost-effective solution for
EMI suppression
- Ceramic technology

IEC climatic category 40/085/21

I_N I_R A	U_N V_R V-	C_N C_R pF	Toleranz Tolerance	Ausführung Version	Maße Dimensions $\varnothing \times l$ (mm)	Bestellnummer Ordering code
6	350	2 × 800	+50/-20%	Schraubbar, Draht / Screw-in, leaded	4,2 × 10	B85313-A-B7
6	350	2 × 800	+50/-20%	Lötbar, Draht / Solderable, leaded	4,2 × 10	B85313-A-B4
6	350	2 × 1600	+30/-20%	Schraubbar, Haken / Screw-in, hooks	4,2 × 17	B85313-A-B3
6	350	2 × 3500	+30/-20%	Schraubbar, Draht / Screw-in, leaded	4,2 × 20	B85313-A-C1



Filter für mittlere Ströme

- Gemäß VDE 0565-1
- FK-Technologie
- Zentrale Schraubbefestigung (16 A)
- Flanschbefestigung (25 A)

IEC-Klimakategorie 40/085/56

Medium-current filters

- In accordance with VDE 0565-1
- FK technology
- Central screw fixing (16 A)
- Flange fixing (25 A)

IEC climatic category 40/085/56

I_N I_R A	U_N V_R V- V_{\sim} , 50/60 Hz	V_{\sim} , 400 Hz	U_P V_P V-	C_N (Klasse) C_R (Class)	Anschlüsse Terminals	Maße Dimensions $\varnothing \times l$ (mm)	Bestellnummer Ordering code
16	250/250	115	2700, 2s	2 × 2500 pF (Y)	Lötfahnen/ Solder lugs	16,0 × 77	B85321-A-B9
16	350/250	115	5000, 2s	2 × 2500 pF (Y)		20,0 × 79	B85321-A-B6
25	350/250	115	1500, 60s	2 × 0,1 μ F (X1)	Gewindeb. M6/ Threaded stud M6	30,5 × 152	B85331-A-B1
25	440/300	115	2500, 60s	2 × 0,05 μ F (X1)		30,5 × 152	B85332-A-B1



Filter für hohe Ströme

- Gemäß VDE 0565-1
- MP-/MKV-Technologie
- Zentrale Schraubbefestigung
- Gewindebolzen-Anschlüsse

IEC-Klimakategorie 40/085/56

High-current filters

- In accordance with VDE 0565-1
- MP/MKV technology
- Central screw fixing
- Threaded stud terminals

IEC climatic category 40/085/56

I_N I_R A/50 Hz	I_N I_R A/400 Hz	U_N V_R V- V_{\sim} , 50/60 Hz	V_{\sim} , 400 Hz	U_P V_P V-, 2 s	C_N (Klasse) C_R (Class) μ F	Gewinde Thread	Maße Dimensions $\varnothing \times l$ (mm)	Bestellnummer Ordering code
40	30	350/250 ¹⁾	250 ¹⁾	1650	2 × 4,7 (-)	M6	56 × 166	B85321-A-J12
40	30	440/250	250	1500	2 × 2 (X2)	M6	56 × 166	B85321-A-J1
40	30	600/250	250	2121	2 × 1 (X2)	M6	56 × 166	B85321-A-J2
100	75	600/250	250	2121	2 × 1 (X2)	M8	56 × 200	B85321-A-J11
200	160	440/250	60	1400	2 × 2,2 (X2)	M10	56 × 271	B85321-A-B7
200	160	750/440	220	2500	2 × 1,2 (X2)	M10	56 × 271	B85321-A-B4
200	160	750/440	440	5400	2 × 0,15 (X1)	M10	56 × 271	B85321-A-C5

1) Nicht für Netzbetrieb / Not for power line operation

Durchführungskondensatoren Feed-through Capacitors



Ausführung mit Anschlußdrähten

- Gemäß VDE 0565-1
- Zentrale Schraubbefestigung

IEC-Klimakategorie 40/100/56 (FK)
40/085/56 (MP)

Version with leads

- In accordance with VDE 0565-1
- Central screw fixing

IEC climatic category 40/100/56 (FK)
40/085/56 (MP)

I_N I_R A	U_N V_R V- V_{\sim} , 50/60 Hz		U_P V_P V-, 2 s	C_N (Klasse) C_R (Class) μF	Technologie Technology	Maße Dimensions $\varnothing \times l$ (mm)	Bestellnummer Ordering code
	V-, 400 Hz						
10	350/250 ¹⁾	115	1500	5000 pF	FK	11 × 41	B85121-D-B1
	350/250 ¹⁾	115	1500	0,01 μF	FK	11 × 41	B85121-D-B2
	160/110	60	750	0,025 μF	FK	11 × 41	B85121-D-B3
	80/ 42	–	900	0,05 μF	FK	11 × 41	B85121-D-B4
	250/100	60	400	0,1 μF	MP	11 × 46	B85121-D-B5
	250/ 42	–	1075	0,05 μF	FK	11 × 46	B85121-D-B6
16	440/250	115	3750	1250 pF (Y)	FK	16 × 42,5	B85121-A-B1
	600/250	220	3950	2500 pF (Y)	FK	16 × 42,5	B85122-A-B2
	440/250	115	3750	5000 pF (Y)	FK	16 × 42,5	B85121-A-B3
	350/250	115	1500	0,025 μF (X2)	FK	16 × 42,5	B85121-A-B7
	350/250	115	1600	0,05 μF (X2)	FK	16 × 52,5	B85121-A-B9
	160/ 75	40	300	1,0 μF	MP	16 × 52,5	B85121-A-B15
25	440/250	115	3750	0,01 μF (Y)	FK	20 × 46	B85121-A-B4
	440/250	115	3750	0,035 μF (Y)	FK	20 × 58	B85121-A-B5
	440/250	115	3750	0,05 μF (Y)	FK	20 × 58	B85121-A-B6
	600/440	220	3950	0,035 μF (X1)	FK	20 × 58	B85121-A-B39
	600/380	125	3600	0,05 μF (X1)	FK	20 × 58	B85121-A-B24
	160/ 75	–	450	1 μF	MP	20 × 52	B85121-A-C37



Ausführung mit Gewindeanschluß

- Gemäß VDE 0565-1
- Zentrale Schraubbefestigung

IEC-Klimakategorie 40/085/56

Version with screw terminals

- In accordance with VDE 0565-1
- Central screw fixing

IEC climatic category 40/085/56

I_N I_R A- A_{\sim}	U_N V_R V- V_{\sim} , 50/60 Hz		U_P V_P V-, 2 s	C_N (Klasse) C_R (Class) μF	Technologie Technology	Maße Dimensions $\varnothing \times l$ (mm)	Bestellnummer Ordering code
	V-, 400 Hz						
50/ 50	440/250	115	2700	0,05 (Y)	FK	SW 27 × 86	B85111-A-B20
100/100	600/440	220	3950	0,035 (X1)	FK	52 × 115	B85111-A-B13
100/100	600/440	220	2500	0,5 (X2)	MP	52 × 115	B85111-A-B14
300/200	600/440	220	3950	0,035 (X1)	FK	52 × 169	B85111-A-B15
300/200	600/440	220	2500	0,5 (X2)	MP	52 × 169	B85111-A-B16
300/200	750/250	220	2500	1,0 (X2)	MKV	56 × 220	B85121-A-B45
600/500	600/440	220	2500	0,5 (X2)	MP	56 × 252	B85121-A-B29
600/500	600/440	220	2500	2,0 (X2)	MP	56 × 244	B85121-A-C18
1000/800 ²⁾	600/440	220	2500	0,5 (X2)	MP	90 × 270	B85111-A-B30

1) Nicht für Netzbetrieb / Not for power line operation

2) >1000 A auf Anfrage / >1000 A upon request

Entstörkondensatoren

EMI Suppression Capacitors



Radiale Anschlußdrähte

- Kunststoffgehäuse (UL 94 V-0)
- Für Netzanwendungen
- Drahtlängen standardmäßig 6 mm und 26 mm (andere Drahtlängen auf Anfrage)

Kapazitätstoleranz: ±20%
(engere Toleranzen auf Anfrage)

Ⓢ nach EN 132 400

⚠ nach EN 132 400

Radial leads

- Plastic case (UL 94 V-0)
- For power lines
- Two standard lead lengths 6 mm and 26 mm (other lead lengths upon request)

Capacitance tolerance: ±20%
(closer tolerances upon request)

Ⓢ to EN 132 400

⚠ to EN 132 400

U _N V _R V~ Vac	RM LS mm	C _N C _R	Maße (max.) Dimensions (max.) b × h × l mm	Bestellnummer ¹⁾ Ordering code ¹⁾	Verpackungseinheiten (Stück) Packing units (pcs)			Prüfzeichen Approvals		
					AMMO-Pack	Rolle Reel	Ungegurtet/Drahtlänge Untaped/Lead length 6 mm 26 mm	Ⓢ	UL	IEC

X1-Kondensatoren/X1 capacitors B81141

IEC-Klimakategorie: 40/085/21
IEC climatic category: 40/085/21



440	15	10 nF	5,0 × 10,5 × 18,0	B81141-C1103-M***	1170	1300	1000	1000	x	Eingereicht Pending	x
		22 nF	7,0 × 12,5 × 18,0	B81141-C1223-M***	830	900	1000	800	x		x
		33 nF	8,5 × 14,5 × 18,0	B81141-C1333-M***	680	700	500	500	x		x
		47 nF	9,0 × 17,5 × 18,0	B81141-C1473-M***	640	700	500	500	x		x
	22,5	68 nF	8,5 × 16,5 × 26,5	B81141-C1683-M***	480	500	510	450	x		x
		0,10 µF	10,5 × 16,5 × 26,5	B81141-C1104-M***	390	400	540	350	x		x
		0,15 µF	11,0 × 20,5 × 26,5	B81141-C1154-M***	370	350	510	300	x		x
	27,5	0,22 µF	12,5 × 21,5 × 31,5	B81141-C1224-M***	–	300	280	200	x		x
		0,33 µF	14,0 × 24,5 × 31,5	B81141-C1334-M***	–	–	260	150	x		x
		0,47 µF	18,0 × 27,5 × 31,5	B81141-C1474-M***	–	–	200	100	x		x

X2-Kondensatoren/X2 capacitors B81130

400/100/21

275	10	10 nF	4,0 × 9,0 × 13,0	B81130-C1103-M***	1000	1700	1000	–	x	x	x
		15 nF	4,0 × 9,0 × 13,0	B81130-C1153-M***	1000	1700	1000	–	x	x	x
		22 nF	5,0 × 11,0 × 13,0	B81130-C1223-M***	830	1300	1000	–	x	x	x
		33 nF	5,0 × 11,0 × 13,0	B81130-C1333-M***	830	1300	1000	–	x	x	x
		47 nF	6,0 × 12,0 × 13,0	B81130-C1473-M***	680	1100	1000	–	x	x	x
	15	22 nF	5,0 × 10,5 × 18,0	B81130-B1223-M***	1170	1300	1000	1000	x	x	x
		33 nF	5,0 × 10,5 × 18,0	B81130-B1333-M***	1170	1300	1000	1000	x	x	x
		47 nF	5,0 × 10,5 × 18,0	B81130-B1473-M***	1170	1300	1000	1000	x	x	x
		68 nF	6,0 × 11,0 × 18,0	B81130-C1683-M***	960	1100	1000	1000	x	x	x
		0,10 µF	6,0 × 11,0 × 18,0	B81130-C1104-M***	960	1100	1000	1000	x	x	x
		0,15 µF	8,5 × 14,5 × 18,0	B81130-C1154-M***	680	700	500	500	x	x	x
		0,22 µF	9,0 × 17,5 × 18,0	B81130-C1224-M***	640	700	500	500	x	x	x
	22,5	0,15 µF	6,0 × 15,0 × 26,5	B81130-B1154-M***	680	700	720	500	x	x	x
		0,22 µF	7,0 × 16,0 × 26,5	B81130-B1224-M***	580	600	630	500	x	x	x
		0,33 µF	8,5 × 16,5 × 26,5	B81130-C1334-M***	480	500	510	450	x	x	x
		0,47 µF	10,5 × 16,5 × 26,5	B81130-C1474-M***	390	400	540	350	x	x	x
		0,68 µF	11,0 × 20,5 × 26,5	B81130-C1684-M***	370	350	510	300	x	x	x
	27,5	0,47 µF	11,0 × 21,0 × 31,5	B81130-B1474-M***	–	350	320	200	x	x	x
		0,68 µF	11,0 × 21,0 × 31,5	B81130-B1684-M***	–	350	320	200	x	x	x
		1,0 µF	12,5 × 21,5 × 31,5	B81130-C1105-M***	–	300	280	200	x	x	x
		1,5 µF	15,0 × 24,5 × 31,5	B81130-C1155-M***	–	–	240	150	x	x	x
		2,2 µF	18,0 × 27,5 × 31,5	B81130-C1225-M***	–	–	200	100	x	x	x

1) Bildung der Bestellnummer siehe Seite 48. / For instructions on how to determine ordering codes, refer to page 52.

U_N V_R V_{\sim} V_{ac}	RM LS mm	C_N C_R	Maße (max.) Dimensions (max.) $b \times h \times l$ mm	Bestellnummer ¹⁾ Ordering code ¹⁾	Verpackungseinheiten (Stück) Packing units (pcs)				Prüfzeichen Approvals		
					AMMO- Pack	Rolle Reel	Ungegurtert/Drahtlänge Untaped/Lead length 6 mm 26 mm				

X2-Kondensatoren/X2 capacitors
B81133

IEC-Klimakategorie: 40/100/21
IEC climatic category: 40/100/21

275	15	22 nF	5,0 × 10,5 × 18,0	B81133-C1223-M***	1170	1300	1000	1000	x	x	x
		33 nF	5,0 × 10,5 × 18,0	B81133-C1333-M***	1170	1300	1000	1000	x	x	x
		47 nF	6,0 × 11,0 × 18,0	B81133-C1473-M***	960	1100	1000	1000	x	x	x
		68 nF	7,0 × 12,5 × 18,0	B81133-C1683-M***	830	900	1000	800	x	x	x
		0,10 µF	8,5 × 14,5 × 18,0	B81133-D1104-M***	680	700	500	500	x	x	x
		0,15 µF	8,5 × 14,5 × 18,0	B81133-D1154-M***	680	700	500	500	x	x	x
	22,5	0,10 µF	6,0 × 15,0 × 26,5	B81133-C1104-M***	680	700	720	500	x	x	x
		0,15 µF	7,0 × 16,0 × 26,5	B81133-C1154-M***	580	600	630	500	x	x	x
		0,22 µF	8,5 × 16,5 × 26,5	B81133-C1224-M***	480	500	510	450	x	x	x
		0,33 µF	10,5 × 16,5 × 26,5	B81133-D1334-M***	390	400	540	350	x	x	x
		0,47 µF	11,0 × 20,5 × 26,5	B81133-D1474-M***	370	350	510	300	x	x	x
		27,5	0,33 µF	11,0 × 21,0 × 31,5	B81133-C1334-M***	–	350	320	200	x	x
	0,47 µF		11,0 × 21,0 × 31,5	B81133-C1474-M***	–	350	320	200	x	x	x
	0,68 µF		12,5 × 21,5 × 31,5	B81133-C1684-M***	–	300	280	200	x	x	x
	1,0 µF		14,0 × 24,5 × 31,5	B81133-C1105-M***	–	–	260	150	x	x	x
	1,5 µF		18,0 × 27,5 × 31,5	B81133-C1155-M***	–	–	200	100	x		

X2-Kondensatoren/X2 capacitors
B81131 (SAFE X)

40/100/21

300	15	10 nF	5,0 × 10,5 × 18,0	B81131-C1103-M***	1170	1300	1000	1000	x	x	x	
		22 nF	6,0 × 11,0 × 18,0	B81131-C1223-M***	960	1100	1000	1000	x	x	x	
		33 nF	7,0 × 12,5 × 18,0	B81131-C1333-M***	830	900	1000	800	x	x	x	
		47 nF	8,5 × 14,5 × 18,0	B81131-C1473-M***	680	700	500	500	x	x	x	
		68 nF	9,0 × 17,5 × 18,0	B81131-C1683-M***	640	700	500	500	x	x	x	
		0,10 µF	9,0 × 17,5 × 18,0	B81131-D1104-M***	640	700	500	500	x	x	x	
	22,5	0,10 µF	7,0 × 16,0 × 26,5	B81131-C1104-M***	580	600	630	500	x	x	x	
		0,15 µF	8,5 × 16,5 × 26,5	B81131-C1154-M***	480	500	510	450	x	x	x	
		0,22 µF	10,5 × 16,5 × 26,5	B81131-C1224-M***	390	400	540	350	x	x	x	
		0,33 µF	11,0 × 20,5 × 26,5	B81131-D1334-M***	370	350	510	300	x	x	x	
		27,5	0,33 µF	11,0 × 21,0 × 31,5	B81131-C1334-M***	–	350	320	200	x	x	x
			0,47 µF	13,5 × 23,0 × 31,5	B81131-C1474-M***	–	250	260	150	x	x	x
	0,68 µF		15,0 × 24,5 × 31,5	B81131-C1684-M***	–	–	240	150	x	x	x	
	1,0 µF		19,0 × 30,0 × 31,5	B81131-C1105-M***	–	–	180	100	x	x	x	

Y1-Kondensatoren/Y1 capacitors
B81123

40/085/21

250	15	1,0 nF	5,0 × 10,5 × 18,0	B81123-C1102-M***	1170	1300	1000	1000	x	x	–
		1,5 nF	6,0 × 11,0 × 18,0	B81123-C1152-M***	960	1100	1000	1000	x	x	–
		2,2 nF	7,0 × 12,5 × 18,0	B81123-C1222-M***	830	900	1000	800	x	x	–
		3,3 nF	8,5 × 14,5 × 18,0	B81123-C1332-M***	680	700	500	500	x	x	–
		4,7 nF	9,0 × 17,5 × 18,0	B81123-C1472-M***	640	700	500	500	x	x	–
	22,5	5,6 nF	7,0 × 16,0 × 26,5	B81123-C1562-M***	580	600	630	500	x	x	–
		6,8 nF	8,5 × 16,5 × 26,5	B81123-C1682-M***	480	500	510	450	x	x	–
		10 nF	10,5 × 18,5 × 26,5	B81123-C1103-M***	390	400	540	300	x	x	–

1) Bildung der Bestellnummer siehe Seite 52. / For instructions on how to determine ordering codes, refer to page 52.

2) Kapazitätstoleranz ±10% / Capacitance tolerance ±10%

Entstörkondensatoren

EMI Suppression Capacitors

U_N V_R $V\sim$	RM LS mm	C_N C_R	Maße (max.) Dimensions (max.) $b \times h \times l$ mm	Bestellnummer ¹⁾ Ordering code ¹⁾	Verpackungseinheiten (Stück) Packing units (pcs)				Prüfzeichen Approvals		
					AMMO-Pack	Rolle Reel	Ungegurtet/Drahtlänge Untaped/Lead length		S	A	E

Y2-Kondensatoren/Y2 capacitors B81122

IEC-Klimakategorie: 40/100/21
IEC climatic category: 40/100/21

250	10	1,0 nF	4,0 × 9,0 × 13,0	B81122-C1102-M***	1000	1700	1000	–	x	x	x
		1,5 nF	4,0 × 9,0 × 13,0	B81122-C1152-M***	1000	1700	1000	–	x	x	x
2,2 nF	5,0 × 11,0 × 13,0	B81122-C1222-M***	830	1300	1000	–	x	x	x		
3,3 nF	5,0 × 11,0 × 13,0	B81122-C1332-M***	830	1300	1000	–	x	x	x		
4,7 nF	6,0 × 12,0 × 13,0	B81122-C1472-M***	680	1100	1000	–	x	x	x		
5,6 nF	6,0 × 12,0 × 13,0	B81122-C1562-M***	680	1100	1000	–	x	x	x		
6,8 nF	6,0 × 12,0 × 13,0	B81122-C1682-M***	680	1100	1000	–	x	x	x		
15	10 nF	5,5 × 11,0 × 18,0	B81122-C1103-M***	1070	1200	1000	1000	x	x	x	
	15 nF	7,0 × 12,5 × 18,0	B81122-C1153-M***	830	900	1000	800	x	x	x	
	22 nF	8,5 × 14,5 × 18,0	B81122-C1223-M***	680	700	500	500	x	x	x	
	27 nF	8,5 × 14,5 × 18,0	B81122-C1273-M***	680	700	500	500	x	x	x	
	33 nF	9,0 × 17,5 × 18,0	B81122-C1333-M***	640	700	500	500	x	x	x	
22,5	47 nF	7,0 × 16,0 × 26,5	B81122-C1473-M***	580	600	630	500	x	x	x	
	56 nF	8,5 × 16,5 × 26,5	B81122-C1563-M***	480	500	510	450	x	x	x	
	68 nF	10,5 × 16,5 × 26,5	B81122-C1683-M***	390	400	540	350	x	x	x	
	0,10 µF	10,5 × 20,5 × 26,5	B81122-C1104-M***	390	400	540	360	x	x	x	
27,5	0,15 µF	11,0 × 21,0 × 31,5	B81122-C1154-M***	–	350	320	200	x	x	x	
	0,22 µF	13,5 × 23,0 × 31,5	B81122-C1224-M***	–	250	260	150	x	x	x	
	0,33 µF	18,0 × 27,5 × 31,5	B81122-C1334-M***	–	–	200	100	x	x	x	



Axiale Anschlußdrähte

- Rundwickel mit Isolierumhüllung

Kapazitätstoleranz ±20%
IEC-Klimakategorie 40/100/21

Axial leads

- Cylindrical winding with insulating sleeve

Capacitance tolerance ±20%
IEC climatic category 40/100/21

U_N V_R $V\sim$	C_N C_R	Maße (max.) Dimensions (max.) $\varnothing \times l$ mm	Bestellnummer Ordering code	Verpackungseinheiten (Stück) Packing units (pcs)		Prüfzeichen Approvals S
				Ungegurtet/Untaped	Ungegurtet/Untaped	
275	10 nF	7,0 × 19,0	B81191-C1103-M	500		x
	15 nF	7,0 × 19,0	B81191-C1153-M	500		x
	22 nF	7,0 × 19,0	B81191-C1223-M	500		x
	33 nF	8,0 × 19,0	B81191-C1333-M	500		x
	47 nF	8,0 × 19,0	B81191-C1473-M	500		x
	68 nF	9,0 × 19,0	B81191-C1683-M	500		x
	0,10 µF	11,0 × 19,0	B81191-C1104-M	500		x
	0,15 µF	9,0 × 26,5	B81191-C1154-M	250		x
	0,22 µF	11,0 × 26,5	B81191-C1224-M	250		x
	0,33 µF	13,0 × 26,5	B81191-C1334-M	250		x
	0,47 µF	15,0 × 26,5	B81191-C1474-M	250		x
	0,68 µF	16,0 × 31,5	B81191-C1684-M	200		x
1,0 µF	19,0 × 31,5	B81191-C1105-M	200		x	

1) Anstelle *** ist die Kennzeichnung für die gewünschte Drahtlänge bzw. Verpackung einzusetzen.
Replace the *** by the code number for the required lead length or packing.

000 = Anschlußdrähte 6 mm (ungegurtet) / lead length 6 mm (untaped)
026 = Anschlußdrähte 26 mm (ungegurtet) / lead length 26 mm (untaped)
289 = gegurtet, AMMO-Pack / taped, Ammo pack
189 = gegurtet, Rollenverpackung / taped, reel

Entstörkondensatoren

EMI Suppression Capacitors



X1-Kondensatoren Metall- bzw. Keramikgehäuse

- Hermetisch dicht
- Gemäß VDE 0565-1
- FK-Technologie
- Gewindebolzen-Anschluß

IEC-Klimakategorie 40/100/56

X1 capacitors Metal or ceramic case

- Hermetically sealed
- In accordance with VDE 0565-1
- FK technology
- Threaded stud terminal

IEC climatic category 40/100/56

$C_N^{1)}$ $C_R^{1)}$ μF	U_N V_R		U_P V_P V~, 2 s	Maße Dimensions $\varnothing \times l$ (mm)	Gehäuse Case	Gewinde Thread	Bestellnummer Ordering code
	V~N~, 50/60 Hz	V~, 400 Hz					
0,035	600/380	220	3600	20,0 × 77	Keramik Ceramic	M6 M6	B81551-A-B7
0,15	440/260	125	2700	31,5 × 89	Metall Metal	M6 M6	B81551-A-B14



X2-Kondensatoren Metall- bzw. Keramikgehäuse

- Gemäß VDE 0565-1
- MP- bzw. MKT-Technologie
- Gewindebolzen-Anschluß

IEC-Klimakategorie 40/085/56

X2 capacitors Metal or ceramic case

- In accordance with VDE 0565-1
- MP or MKT technology
- Threaded stud terminal

IEC climatic category 40/085/56

$C_N^{1)}$ $C_R^{1)}$ μF	U_N V_R		U_P V_P V~, 2 s	Maße Dimensions $\varnothing \times l$ (mm)	Gehäuse Case	Gewinde Thread	Bestellnummer Ordering code
	V~N~, 50/60 Hz	V~, 400 Hz					
0,6 (MP)	800/440	220	2500	38 × 95	Metall, hermetisch dicht Metal, hermetically sealed	M6 M6	B81551-A-B16
1,0 (MKT)	125/ 50	–	350	20 × 61	Keramik, vergossen Ceramic, potted	M6 M6	B81551-A-C9 B81551-A-D9

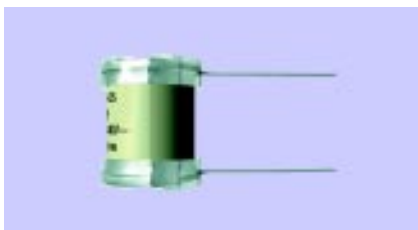

Y-Kondensatoren Keramikgehäuse

- Hermetisch dicht
- Gemäß VDE 0565-1
- FK-Technologie

IEC-Klimakategorie 40/100/56

Y capacitors Ceramic case

- Hermetically sealed
- In accordance with VDE 0565-1
- FK technology

IEC climatic category 40/100/56

$C_N^{1)}$ $C_R^{1)}$ μF	U_N V_R		U_P V_P V~, 2 s	Maße Dimensions $\varnothing \times l$ (mm)	Anschlüsse Terminals	Bestellnummer Ordering code
	V~N~, 50/60 Hz	V~, 400 Hz				
0,01	440/250	115	3000	15 × 22	Anschlußfahne und Gewindebolzen Flat lead and threaded stud	B81551-A-C3
0,025	440/280	115	3000	19 × 30	Anschlußfahne und Gewindebolzen Flat lead and threaded stud	B81551-A-D4
0,025	440/280	115	3000	19 × 25	Beidseitig Anschlußfahne Flat leads on both sides	B81151-A-D5

1) Kapazitätstoleranz ±20% / Capacitance tolerance ±20%

Entstörvaristoren

EMI Suppression Varistors



SHCV-SR

- Kombination Vielschicht-Keramik-Kondensator/Vielschicht-Varistor
- Epoxidharzumhüllung (UL 94 V-0)
- Keramikart X7R (= Typ.....X)
- Keramikart Z5U (= TypZ)

IEC-Klimakategorie 40/085/56 (X)
25/085/56 (Z)

Spannungsfestigkeit >1,0 kV
Anspruchzeit <25 ns

SHCV-SR

- Combination of a multilayer ceramic capacitor and a multilayer varistor
- Epoxy resin coating (UL 94 V-0)
- Ceramic material X7R (= type.....X)
- Ceramic material Z5U (= typeZ)

IEC climatic category 40/085/56 (X)
25/085/56 (Z)

Electric strength >1,0 kV
Response time <25 ns

Grenzdaten ($T_A = 85\text{ °C}$)

Maximum ratings ($T_A = 85\text{ °C}$)

Typ Type SHCV-	Bestellnummer Ordering code	V_{RMS} V	V_{DC} V	i_{max} (8/20 μ s) A	W_{max} (2 ms) J	P_{max} W	W_{LD} (10x) J
-SR1S14BM474X	Q69587-E3140-S200	14	16	800	2,4	0,015	6
-SR2S14BM474X	Q69547-E3140-S200	14	16	1200	5,8	0,03	12
-SR1S14BM105Z	Q69588-G3140-S200	14	16	800	2,4	0,015	6
-SR1S14BM155Z	Q69588-H3140-S200	14	16	800	2,4	0,015	6
-SR2S14BM105Z	Q69548-G3140-S200	14	16	1200	5,8	0,03	12
-SR2S14BM155Z	Q69548-H3140-S200	14	16	1200	5,8	0,03	12
-SR1K20M474X	Q69587-E3200-K	20	26	800	3,0	0,015	6
-SR2K20M474X	Q69547-E3200-K	20	26	1200	7,8	0,03	12
-SR1K20M105Z	Q69588-G3200-K	20	26	800	3,0	0,015	6
-SR1K20M155Z	Q69588-H3200-K	20	26	800	3,0	0,015	6
-SR2K20M105Z	Q69548-G3200-K	20	26	1200	7,8	0,03	12
-SR2K20M155Z	Q69548-H3200-K	20	26	1200	7,8	0,03	12

Kenndaten ($T_A = 25\text{ °C}$)

Characteristics ($T_A = 25\text{ °C}$)

Typ Type SHCV-	V_{jump} (5 min.) V	V_V (1mA) V	ΔV_V (1mA) %	Max. Schutzpegel Max. clamping		Kapazität ¹⁾ Capacitance ¹⁾ μ F	Maße (mm) Dimensions (mm)		
				V	A		Länge Length	Breite Width	Höhe Height
-SR1S14BM474X	24,5	22	+23/-0	40	5,0	0,47	7,3	3,6	7,8
-SR2S14BM474X	24,5	22	+23/-0	40	10,0	0,47	7,8	3,6	9,0
-SR1S14BM105Z	24,5	22	+23/-0	40	5,0	1,00	7,3	4,0	7,8
-SR1S14BM155Z	24,5	22	+23/-0	40	5,0	1,50	7,3	4,1	7,8
-SR2S14BM105Z	24,5	22	+23/-0	40	10,0	1,00	7,8	4,0	9,0
-SR2S14BM155Z	24,5	22	+23/-0	40	10,0	1,50	7,8	4,1	9,0
-SR1K20M474X	26,0	33	\pm 10	58	5,0	0,47	7,3	3,6	7,8
-SR2K20M474X	26,0	33	\pm 10	58	10,0	0,47	7,8	3,6	9,0
-SR1K20M105Z	26,0	33	\pm 10	58	5,0	1,00	7,3	4,0	7,8
-SR1K20M155Z	26,0	33	\pm 10	58	5,0	1,50	7,3	4,1	7,8
-SR2K20M105Z	26,0	33	\pm 10	58	10,0	1,00	7,8	4,0	9,0
-SR2K20M155Z	26,0	33	\pm 10	58	10,0	1,50	7,8	4,1	9,0

1) \pm 20% (1kHz)

Gurtung und Verpackung

Taping and Packing

SMD-Bauelemente / SMDs

Gurtungsspezifikation: DIN IEC 286 Teil 3 (Blistergurt) / Taping specification: IEC 286-3 (blister tape)

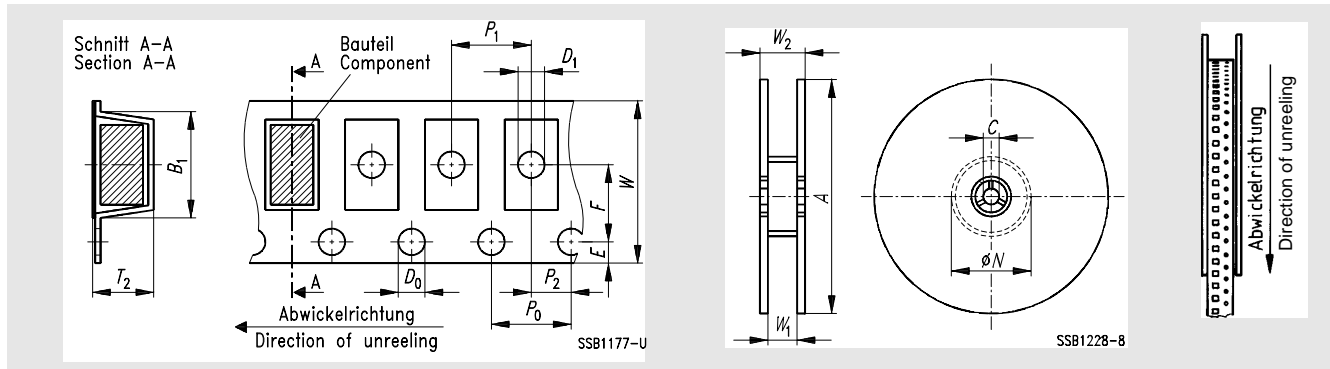

Gurtmaße / Tape dimensions

Maße Dim.	Baugrößen/Bauformen Sizes/Types								Datenleitungsdrösel Data line choke	
	0402 B82499	0603 B82496	0805 B82498	1008 B82494	1210 B82412	1210 B82422	1812 B82432	2220 B82442	B82790- +****-N2	B82790- -C****-N3
W	$8,0 \pm 0,2$	$8,0 \pm 0,3$					$12 \pm 0,3$		$16 \pm 0,3$	$24 \pm 0,3$
D_0	$1,55 \pm 0,05$	$1,5 + 0,1/-0$					$1,5 \pm 0,1$		$1,5 \pm 0,1$	$1,5 \pm 0,1$
D_1	–	–	–	$1,0 \pm 0,2$	$1,0 + 0,2$	$1,0 + 0,2$	$1,6 \pm 0,1$	$1,6 \pm 0,1$	$1,6 \pm 0,1$	$1,6 \pm 0,1$
P_0	$4,0 \pm 0,1$	$4,0 \pm 0,1$					$4 \pm 0,1$		$4 \pm 0,1$	$4 \pm 0,1$
P_1	$2,0 \pm 0,05$	$4,0 \pm 0,1$	0402 = Pappgurt				$8 \pm 0,1$		$8 \pm 0,1$	$16 \pm 0,1$
P_2	$2,0 \pm 0,05$	$2,0 \pm 0,05$	0603 ... 2220 = Blistergurt						$2 \pm 0,1$	$2 \pm 0,1$
E	$1,75 \pm 0,1$	$1,75 \pm 0,1$	0402 = Cardboard tape				$2 \pm 0,05$		$2 \pm 0,1$	$2 \pm 0,1$
F	$3,5 \pm 0,05$	$3,5 \pm 0,05$	0603 ... 2220 = Blister tape				$1,75 \pm 0,1$		$1,75 \pm 0,1$	$1,75 \pm 0,1$
B_1	$1,21 \pm 0,05$	1,8	$\leq 3,1$	$\leq 2,9$	$\leq 4,2$	$\leq 4,2$	$\leq 5,9$	$\leq 7,2$	$\leq 10,5$	≤ 17
T_2	$\leq 1,0$	$\leq 1,2$	$\leq 2,0$	$\leq 1,85$	$\leq 2,0$	$\leq 2,6$	$\leq 4,1$	$\leq 6,0$	$\leq 6,0$	≤ 8

Rollenverpackung / Reel packing

Baugrößen/Bau- formen Sizes/Types		Maße (mm) Dimensions (mm)					Stück pro Rolle Pieces per reel	
		A	W_1	W_2	C	$\varnothing N$	$\varnothing 180$ mm	$\varnothing 330$ mm
0402	B82499	$178 \pm 2,0$	$9 \pm 0,3$	–	$13,0 \pm 0,5$	$60 \pm 0,5$	10000	–
0603	B82496	$178 \pm 2,0$	$9 \pm 0,3$	–	$13,0 \pm 0,5$	$60 \pm 0,5$	3000	–
0805	B82498	$180 +0/-4$	$8,4 +1,5/-0$	14,4 max.	$12,75 + 0,15/-0$	$62 \pm 1,5$	3000	10000 ¹⁾
1008	B82494	$180 +0/-4$	$8,4 +1,5/-0$	14,4 max.	$12,75 + 0,15/-0$	$62 \pm 1,5$	2000	–
1210	B82412	$180 +0/-2$ $330 +0/-2$	$8,4 +1,5/-0$	14,4 max.	$12,75 + 0,15/-0$	$62 \pm 1,5$	2500	10000
1210	B82422	$180 +0/-2$ $330 +0/-2$	$8,4 +1,5/-0$	14,4 max.	$12,75 + 0,15/-0$	$62 \pm 1,5$	2000	8000
1812	B82432	$330 +0/-2$	$12,4 +1,5/-0$	18,4 max.	$12,75 + 0,15/-0$	$62 \pm 1,5$	–	2500
2220	B82442	$330 +0/-2$	$12,4 +1,5/-0$	18,4 max.	$12,75 + 0,15/-0$	$62 \pm 1,5$	–	1500
B82790-+****-N2		$330 +0/-2$	$16,4 +2/-0$	20,4 max.	$12,75 + 0,15/-0$	$62 \pm 1,5$	–	1500
B82790-C****-N3		$330 +0/-2$	$24,4 +2/-0$	28,4 max.	$12,75 + 0,15/-0$	$62 \pm 1,5$	–	500

1) Nur für B82498-B / For B82498-B only.

Gurtung und Verpackung Taping and Packing

Axial bedrahte Drosseln / Axial-lead chokes

Gurtungsspezifikation: DIN IEC 286 Teil 1 / Taping specification: IEC 286-1

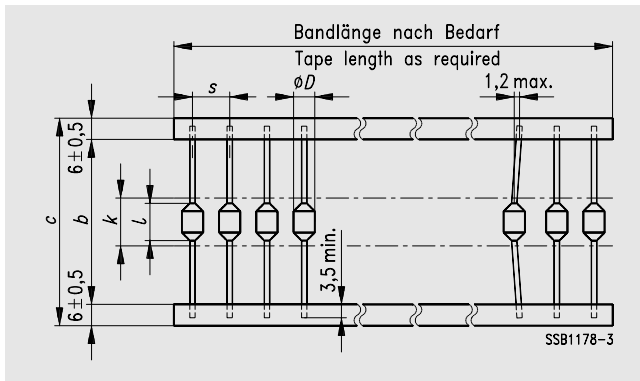

Maße Dim. (mm)	Bauformen/Types B78108-T, -S; B82141... B82145						UKW-Drosseln VHF chokes
	MCC	SBC	BC	HBC	LBC	HLBC	
b	53						73 -1
c	65 ±1						86 ±1
s	5 ±0,25			10 ±0,25			10 ±0,5
Ø D	Entsprechend Bauelementespezifikation						
l max.	According to component specification						
k	l max +1,4						

Radial bedrahtete Drosseln / Radial-lead chokes

Gurtungsspezifikation: DIN IEC 286 Teil 2 / Taping specification: IEC 286-2

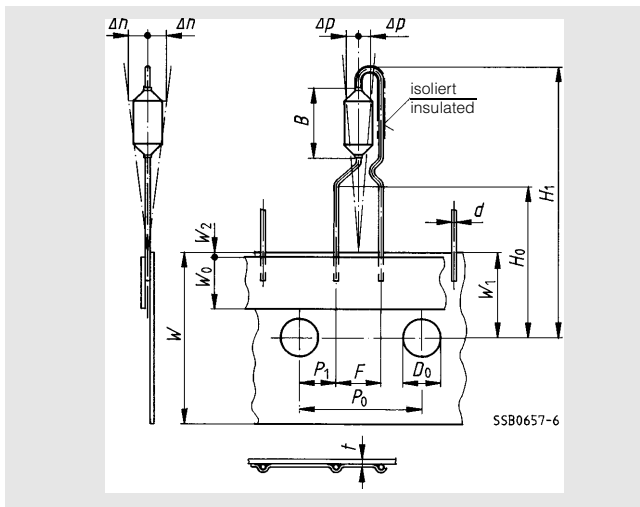

Maße Dim. (mm)	Bauformen/Types				Toleranz Tolerance mm
	B78148-T MCC	B82141-B SBC	B78148-S BC	B82143 HBC	
F	5	5	5	5	+0,6/-0,1
B ¹⁾	7	6,8	9,2	9,2	max.
Ød ₁	0,55	0,55	0,7	0,7	max.
H ₁	29	29	30,5	30,5	max.
H ₀	16	16	16	16	± 0,5
W	18,0 + 1/-0,5		P ₁	3,8 ± 0,7	
W ₀	6,0 min.		P ₀	12,7 ± 0,3	
W ₁	9,0 + 0,75/-0,5		D ₀	4,0 ± 0,2	
W ₂	0,5 max.		Δh	2 max.	
t	0,7 ± 0,2		Δp	1,3 max.	

1) Nach DIN 41 099 / In accordance with DIN 41 099

Radial bedrahtete Entstörkondensatoren / Radial-lead EMI suppression capacitors

Gurtungsspezifikation: DIN IEC 286 Teil 2 / Taping specification: IEC 286-2

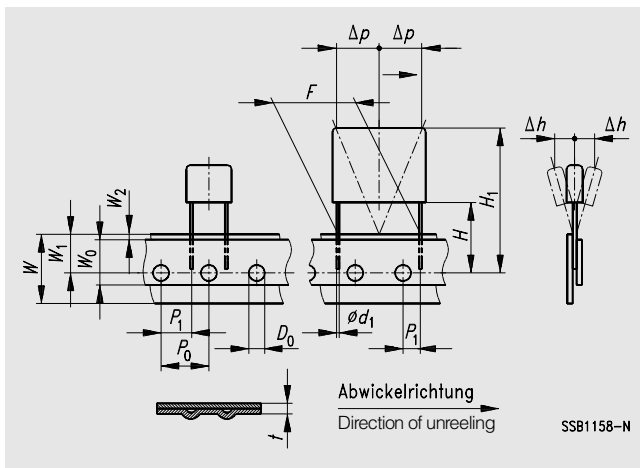

Maße Dim. (mm)	Bauformen Types B81121 ... B81141				Toleranz Tolerance mm	
	10	15	22,5	27,5		
F	10	15	22,5	27,5	+0,6/-0,1	
Ød ₁	0,6	0,8	0,8	0,8	+10 %/-0,05 mm	
H ₁	32,2	36,5	39,5	40,5	max.	
P ₁	7,7	5,2	7,8	5,3	± 0,7	
H	18,5 ± 0,5				P ₀	12,7 ± 0,2 (±1/20 x P)
W	18,0 ± 0,5				D ₀	± 0,2
W ₀	12,0 ± 0,5				Δh	± 2,0
W ₁	9,0 ± 0,5				Δp	± 1,3
W ₂	0,5 + 2,5				t	0,7 ± 0,2

Gurtung und Verpackung Taping and Packing

Rollenverpackung Drosseln, axial und radial Reel packing chokes, axial and radial

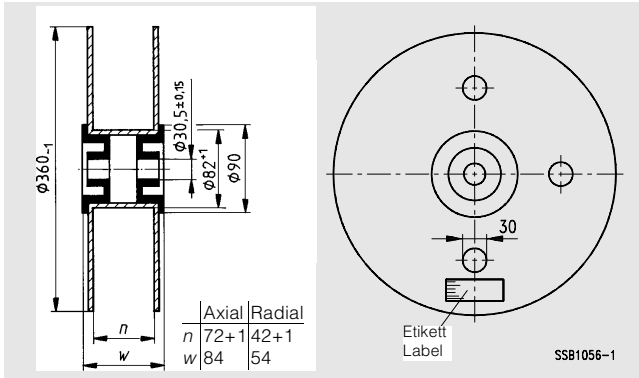

Verpackungseinheiten Packing units

Bauformen Types		Stück (Rolle) / Pcs. (reel)	
		Axial	Radial
MCC	B781*8-T	5000	2000
SBC	B82141	5000	2000
BC	B781*8-S	5000	2000
HBC	B82143	5000	2000
LBC	B82144	1500	
HLBC	B82145	1250	
UKW-Drosseln	B82111-E	1000	
VHF chokes	B82131...132	2000	
	B82133...134	1000	

Rollenverpackung UKW-Drossel B82111-E Reel packing VHF choke B82111-E

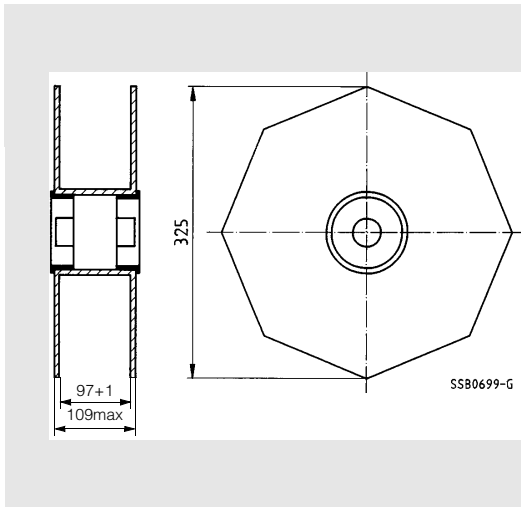

Rollenverpackung UKW-Drosseln B82131...B82134 Reel packing VHF chokes B82131...B82134

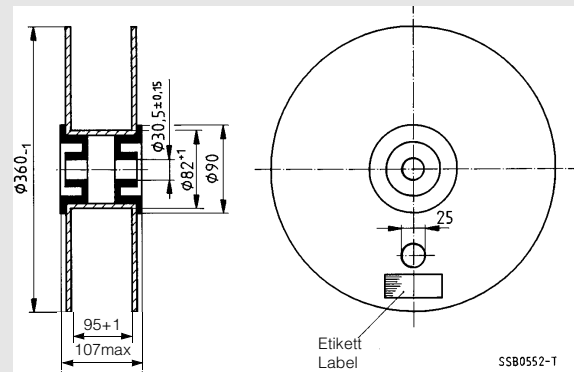

Verpackung Entstörkondensatoren Packing EMI suppression capacitors

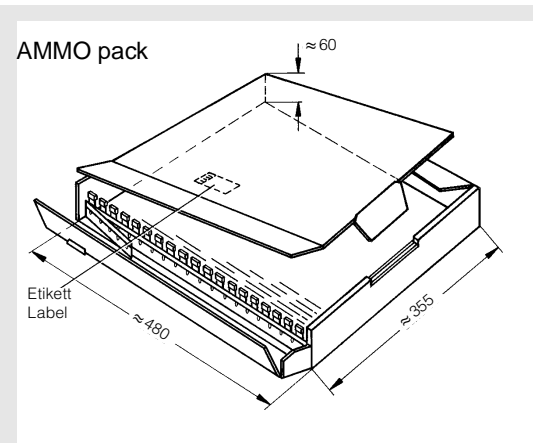
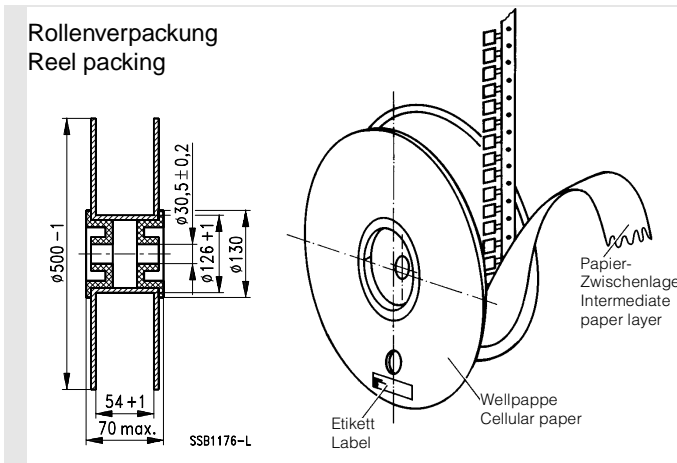

EMV-Labor

EMC Laboratory

Um eine Vielzahl elektrischer Geräte und Anlagen nebeneinander betreiben zu können, muß das Schutzziel „Elektromagnetische Verträglichkeit“ (EMV) erreicht werden. Das deutsche EMV-Gesetz sowie die Europäische EMV-Richtlinie schreiben dieses Schutzziel zwingend vor. Europäische und nationale Normen schreiben technische Anforderungen an Geräte sowie Meß- und Prüfverfahren fest. Sie enthalten z. B. die einzuhaltenden Grenzwerte für die Störaussendung und die Schärfegrade für die Störfestigkeit.

In Regensburg betreiben wir ein umfangreich ausgestattetes EMV-Labor für die Unterstützung unserer Kunden bei Entstörproblemen und für grundlegende Untersuchungen bei der Applikation von EMV-Bauelementen. Dort werden für Geräte, Anlagen und Maschinen die wirtschaftlich günstigsten Entstörbeschaltungen ermittelt.

Unser EMV-Labor in Regensburg bietet Ihnen umfassende und fachlich hochqualifizierte EMV-Dienstleistungen:

- Entwicklungsbegleitende Beratung und Schulung
- EMV-Messungen und -Prüfungen an Prototypen
- EMV-Prüfungen für die Konformitätserklärung zur CE-Kennzeichnung
- Abnahmemessungen der Seriengeräte

Die umfassende Ausstattung des Labors, unsere langjährige Erfahrung und hohe EMV-Kompetenz (erste Absorberhalle Europas 1963) sowie aktive Mitarbeit in nationalen und internationalen EMV-Normungsgremien bilden eine hervorragende Grundlage, den hohen Anforderungen unserer Kunden gerecht zu werden.

EMV-Prüfungen

Unser EMV-Labor kann nach nahezu allen gültigen nationalen und internationalen Normen prüfen. Selbstverständlich sind darüber hinaus auch Prüfungen nach anderen einschlägigen EMV-Vorschriften durchführbar.

Qualifikation

Das EMV-Labor ist akkreditiert nach den Richtlinien des DAR (Deutscher Akkreditierungs Rat) und Mitglied in der Zuständigen Stelle der Siemens AG (ZFE GR TN ZF) gemäß EMV-Gesetz.

In order to be able to operate a large number and variety of electrical devices simultaneously, the protection-oriented objective of "Electromagnetic compatibility" (EMC) must be achieved. The German EMC law and the European EMC Directive make this objective mandatory. European and national standards specify the technical requirements for equipment as well as the related measuring and testing methods. For example, they specify the mandatory limits for interference emissions and the severity of immunity tests.

We operate an extensively equipped EMC laboratory in Regensburg to support our customers in solving interference problems and for carrying out fundamental research on EMC component applications. In this lab, the most economical interference suppression circuits for devices, plants and machineries are determined.

Our EMC laboratory offers the producer of electrical equipment comprehensive and highly qualified service:

- Advisory and training services accompanying the development phase
- EMC testing of prototypes
- EMC tests to enable a declaration of conformity to be made for the CE mark
- Acceptance inspection of industrial equipment

The all-inclusive facilities of the laboratory, many years of experience and specialist competence in the entire field of EMC (Europe's first anechoic chamber in 1963) plus active cooperation on national and international EMC standards committees all combine to form a solid foundation for satisfying the high demands set by the customer.

EMC tests

The EMC laboratory in Regensburg can conduct tests to virtually all national and international EMC standards. Tests in line with other valid EMC requirements are also possible of course.

Qualification

The EMC laboratory is accredited according to the directives of the GAR (German Accrediting Council) and a member of the competent body of Siemens AG (ZFE GR TN ZF) as prescribed by EMC legislation.

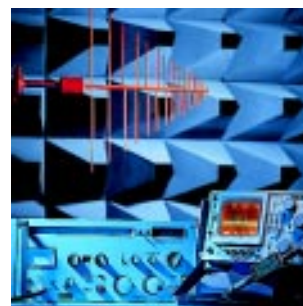
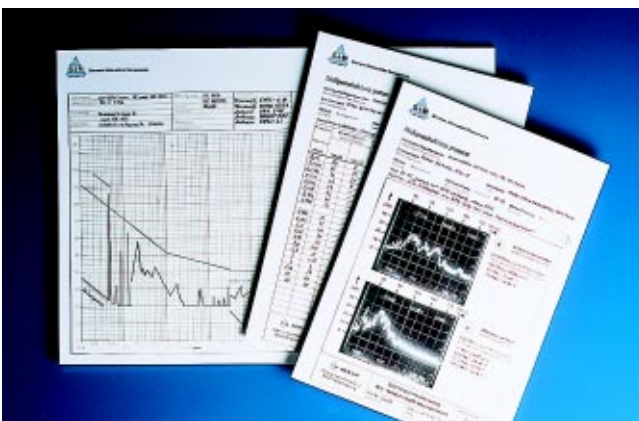

Störfeldstärkemessung mit Spectrum Analyzer und Meßempfänger
Measuring radiated emission with spectrum analyzer and test receiver



Automatische Messung mit Zugriff zu allen Meßplätzen
Automatic tests with access to all test setups

Ausstattung

■ Absorberhalle

Das EMV-Labor verfügt über eine Absorberhalle mit reflektierendem Boden für Feldstärkemessungen nach allen einschlägigen Meßvorschriften bei Meßabständen bis 10 m.

Die Absorberhalle ist an den Wänden und der Decke partiell mit Schachtabsorbern ausgekleidet, um eine reflektionsfreie Meßumgebung zu schaffen. Für Störfestigkeitsuntersuchungen können Felder bis etwa 20 V/m in 2 m Abstand erzeugt werden. Zusätzliche mobile Absorber können je nach Meßproblem als Wand- und Bodenabsorber eingesetzt werden. Die Halle eignet sich auch für die Prüfung größerer Objekte, z. B. von EDV-Anlagen oder Kraftfahrzeugen.

■ Meßplätze

Für Untersuchungen leitungsgebundener Störungen stehen zwei geschirmte Kabinen mit drei Meßplätzen zur Verfügung.

Um jederzeit genaue und reproduzierbare Messungen gewährleisten zu können, werden die Meß- und Prüfeinrichtungen jährlich kalibriert und regelmäßig mit unseren internen Vergleichsnormen überprüft.

Jeder der drei Meßplätze kann alternativ mit den eigenen Meßgeräten oder mit dem zentralen, automatisierten Meßgerät arbeiten. Die Meßergebnisse werden mit Hilfe eines Plotters dokumentiert.

Meß- und Prüfgeräte für strahlungsgebundene EMV

Aussendung

Meßempfänger	10 kHz ... 1000 MHz
Netznachbildungen	4 x 100 A
Antennen	10 kHz ... 1000 MHz
Spectrum-Analyzer	0 GHz ... 18 GHz
Absorberzangen	30 MHz ... 1000 MHz

Beeinflussung

Signalgeneratoren	10 kHz ... 1000 MHz
Leistungsverstärker	25 W ... 250 W
Antennen, Richtkoppler, Zusatzabsorber	

Meß- und Prüfgeräte für leitungsgebundene EMV

Aussendung

Meßempfänger	10 kHz ... 30 MHz
Netznachbildungen	4 x 100 A
Oberwellenmeßgeräte	... 8 A
Oszilloskope, Tastköpfe, Stromzangen	

Beeinflussung

Signalgeneratoren	10 kHz ... 30 MHz
Leistungsverstärker	25 W ... 250 W
Impulsgeneratoren	ESD EN 61000-2
	Burst EN 61000-4
	Surge EN 61000-5

Ankoppelnetzwerke, kapazitive Koppelzange

Equipment

■ Anechoic chamber

The EMC laboratory incorporates an anechoic chamber with a reflecting floor (ground plane) for measurement of field strength according to all regulations at distances up to 10m.

The anechoic chamber is partially lined with shaft absorbers on its walls and ceiling to create a testing environment that is free from reflections. For examinations of immunity it is possible to generate fields of some 20 V/m at a distance of 2 m. Depending on the application, extra mobile absorbers can be wheeled in for walls or the floor. The chamber is also suitable for testing large objects, even complete computer installations or automobiles.

■ Shielded enclosures

For investigations of conducted interference there are two shielded enclosures with three test stations.

To ensure precise and reproducible measured results at all times, test facilities are calibrated annually and regularly examined with inhouse reference standards.

Each of the three test stations can work either with its own or with automated, central instrumentation. All results are documented by a plotter.

Test equipment for radiated EMC

Emission

Test receivers	10 kHz ... 1000 MHz
LISNs	4 x 100 A
Antennas	10 kHz ... 1000 MHz
Spectrum analyzers	0 GHz ... 18 GHz
Absorbing clamps	30 MHz ... 1000 MHz

Immunity

Signal generators	10 kHz ... 1000 MHz
Power amplifiers	25 W ... 250 W
Antennas, directive couplers, extra absorbers	

Test equipment for conducted EMC

Emission

Test receivers	10 kHz ... 30 MHz
LISNs	4 x 100 A
Harmonic meters	... 8 A
Oscilloscopes, probes, current probes	

Immunity

Signal generators	10 kHz ... 30 MHz
Power amplifiers	25 W ... 250 W
Pulse generators	ESD EN 61000-2
	Burst EN 61000-4
	Surge EN 61000-5

Coupling networks, capacitive clamps

Symbole und Begriffe

Symbols and Terms

Symbol	Bedeutung	Symbol	Term
α_e	Einfügungsdämpfung	α_e	Insertion loss
C_N	Nennkapazität	C_R	Rated capacitance
f	Frequenz	f	Frequency
f_L	Meßfrequenz für Induktivität	f_L	Measuring frequency for inductance
f_Q	Meßfrequenz für Güte	f_Q	Measuring frequency for quality factor
f_{res}	Resonanzfrequenz	f_{res}	Resonance frequency
i_{max}	Stoßstrom	i_{max}	Surge current
I_{Abl}	Ableitstrom	I_{leak}	Leakage current
I_N	Nennstrom	I_R	Rated current
L	Induktivität	L	Inductance
L_N	Nenninduktivität	L_R	Rated inductance
L_S	Streuinduktivität	L_S	Stray inductance (leakage inductance)
P_{max}	Dauerbelastbarkeit	P_{max}	Power dissipation
Q_{min}	Güte	Q_{min}	Quality factor
R_{is}	Isolationswiderstand	R_{is}	Insulation resistance
R_{DC}	Gleichstromwiderstand	R_{DC}	DC resistance
R_{max}	Gleichstromwiderstand, Maximalwert	R_{max}	DC resistance, maximum value
R_{min}	Gleichstromwiderstand, Mindestwert	R_{min}	DC resistance, minimum value
R_{typ}	Gleichstromwiderstand, typischer Wert	R_{typ}	DC resistance, typical value
U_N	Nennspannung	V_R	Rated voltage
U_P	Prüfspannung	V_P	Test voltage
V_{DC}	Betriebsgleichspannung	V_{DC}	Operating dc voltage
V_{jump}	Jump start	V_{jump}	Jump start
V_v	Varistorspannung	V_v	Varistor voltage
V_{RMS}	Betriebswechselfspannung	V_{RMS}	Operating ac voltage
W_{max}	Energieabsorption	W_{max}	Energy absorption
W_{LD}	Load Dump	W_{LD}	Load dump
Z	Scheinwiderstand	Z	Impedance
RM	Rastermaß (in mm)	LS	Lead spacing (in mm)

Decimal points are indicated by commas

Prüfzeichen

Approvals

 VDE Deutschland/Germany	 SEV Schweiz/Switzerland	 DEMKO Dänemark/Denmark	 SETI Finnland/Finland	 NEMKO Norwegen/Norway
 SEMKO Schweden/Sweden	 ÖVE Österreich/Austria	 IMQ Italien/Italy	 UL USA	 CSA Kanada/Canada

Kondensatoren, Drosseln und Filter werden in Zukunft nach den neuen Europeanormen EN 132 400, EN 138 100 und EN 133 200 bzw. EN 123 221 geprüft.

In future, capacitors, chokes and filters will be tested in accordance with the new European standards EN 132 400, EN 138 100 and EN 133 200 or EN 133 221.