

The Gemini Series "A" Series Toggles 5 Amp

Refer to Pages C32-C36 for Additional Options

"A" SERIES DESIGN FEATURES

- Meets CSA Requirements
- Toggle – Machined brass, heavy nickel plated.
- Bushing & Frame – Rigid one-piece die cast, copper flashed, heavy nickel plated.
- Fixed Contact – Welded construction, selective placement of precious metal. (Gold or silver.)
- Movable Contact – "Captured" design eliminates possibility of displacement due to shock. (01 function.)
- Terminal Seal – Epoxy sealing of terminals is standard.
- Termination – Precious metal (or silver)/brass or copper strip with welded contact area.
- Case – DAP for electrical performance and mechanical strength, UL94VO.

MATERIAL SPECIFICATIONS:

ContactsGold/gold flash
 Silver/tin lead
 Case MaterialThermoset
 Terminal SealEpoxy

ENVIRONMENTAL SPECIFICATIONS

Operating Temperature-20°C to +85°C (-4°F to +185°F)
 Storage Temperature-45°C to +100°C (-49°F to +212°F)
 Solder Heat ResistanceSee page M6-7

TYPICAL PERFORMANCE CHARACTERISTICS:

Contact RatingGold: 0.4 VA @ 20 VAC/DC
 Silver: 2 A @ 250 VAC: 5 A @ 125 VAC
 Initial Contact Resistance30 Milliohms max.
 Contact TimingBreak before make
 Insulation Resistance1,000 Megohms @ 500 VDC.
 Dielectric Strength1,000 Volts RMS @ sea level
 Actuation ForceMomentary: 950 Grams max.
 Plunger/Actuator TravelMaintained: 1750 Grams max. 25°
 Life Expectancy30,000 Cycles



SPDT



A101SYZQ

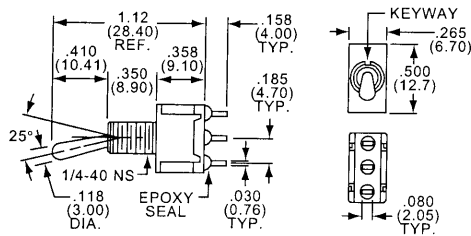

Model	Type	Act. Code	P.M8	↖	↓	↗
Silver Contacts						
A101SYZQ	SPDT	1	On	None	On	
A103SYZQ	SPDT	5	On	Off	On	
A105SYZQ	SPDT	5	(On)	Off	(On)	
A107SYZQ	SPDT	5	On	Off	(On)	
A108SYZQ	SPDT	1	On	None	(On)	
Gold Contacts						
A101SYZB	SPDT	1	On	None	On	
A103SYZB	SPDT	5	On	Off	On	
A105SYZB	SPDT	5	(On)	Off	(On)	
A107SYZB	SPDT	5	On	Off	(On)	

DPDT



A201SYZQ

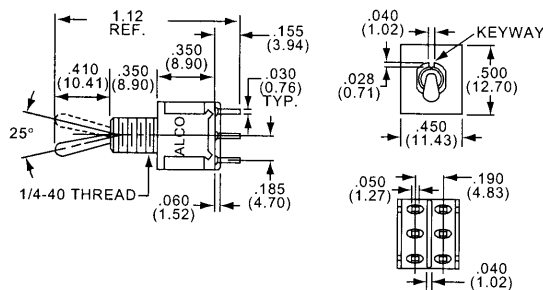

Model	Type	Act. Code	P.M8	↖	↓	↗
Silver Contacts						
A201SYZQ	DPDT	2	On	None	On	
A203SYZQ	DPDT	6	On	Off	On	
A205SYZQ	DPDT	6	(On)	Off	(On)	
A207SYZQ	DPDT	6	On	Off	(On)	
A208SYZQ	DPDT	2	On	None	(On)	
A211SYZQ	DP3T	11	On	On	On	
A213SYZQ	DP3T	11	On	On	(On)	
A215SYZQ	DP3T	11	(On)	On	(On)	

Thomas & Betts

Quality & Innovation From **AUGAT**® Name Brand Products

C24

Thomas & Betts
 8155 T&B Blvd.
 Memphis, TN 38125
 (901) 252-5000 FAX (901) 252-1380

"A" Series Toggles The Gemini Series

Refer to Pages C32-C36 for Additional Options

SEE PAGE C24 FOR PRODUCT SPECIFICATIONS

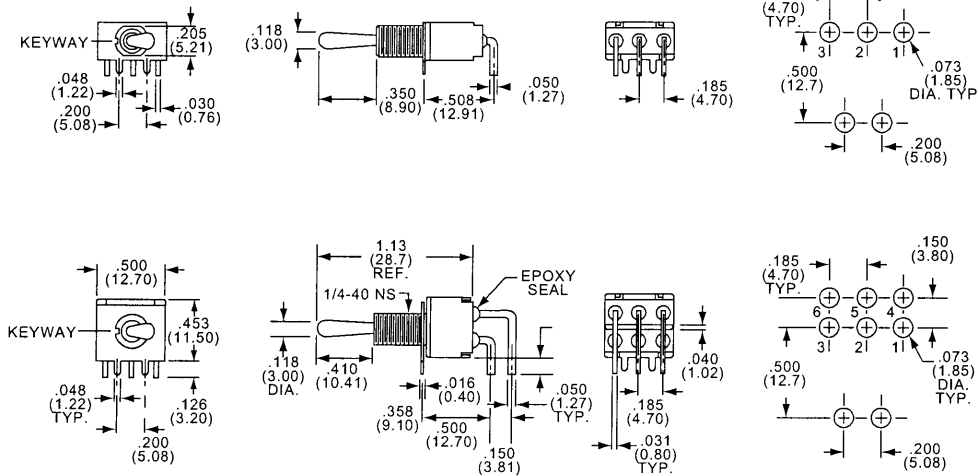

SPDT/DPDT



A101SYAB
Horizontal Actuation



Gold Contacts Model	Type	Act. Code	P.M8			
A101SYAB	SPDT	1	On	None	On	
A103SYAB	SPDT	5	On	Off	On	
A201SYAB	DPDT	2	On	None	On	
A208SYAB	DPDT	2	On	None	(On)	

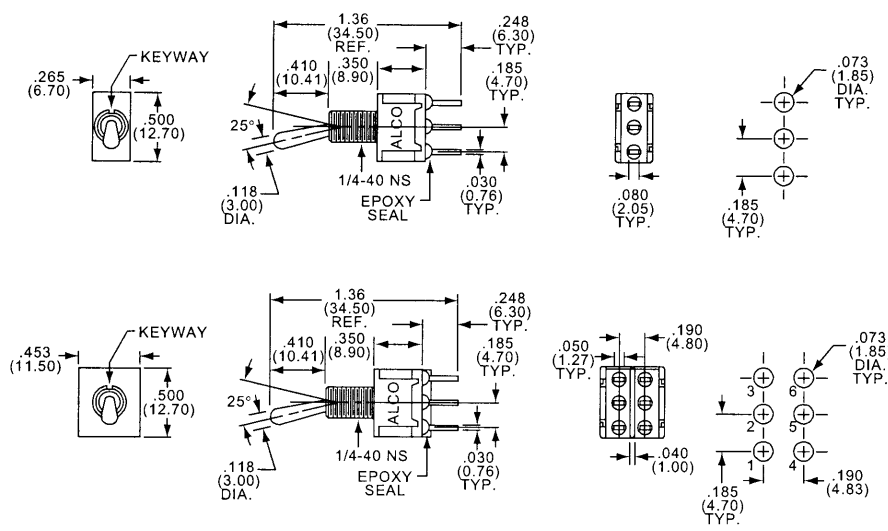

SPDT/DPDT

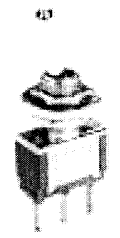

A101SYCB

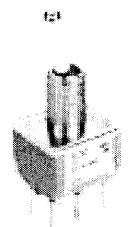

A201SYCB

Gold Contacts Model	Type	Act. Code	P.M8			
A101SYCB	SPDT	1	On	None	On	
A103SYCB	SPDT	5	On	Off	On	
A108SYCB	SPDT	1	On	None	(On)	
A201SYCB	DPDT	2	On	None	On	
A203SYCB	DPDT	6	On	Off	On	
A208SYCB	DPDT	2	On	None	(On)	

Need more technical information?
Consult your Thomas & Betts sales office listed on the back cover

Thomas & Betts
8155 T&B Blvd.
Memphis, TN 38125
(901) 252-5000 FAX (901) 252-1380

The Gemini Series "A" Series Toggles "Wire Wrap/Wire Lug"

Refer to Pages C32-C36 for Additional Options

SEE PAGE C24 FOR PRODUCT SPECIFICATIONS

SPDT/DPDT

C



A101SYWQ



A201SYWQ

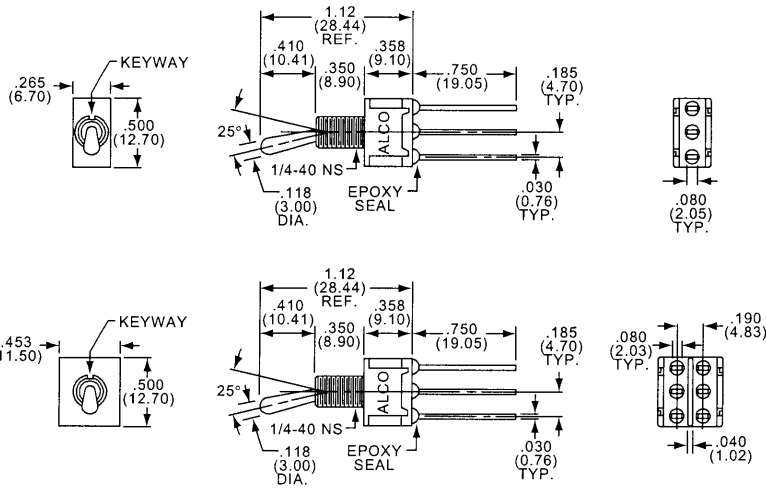

Model	Silver Contacts	Type	Act .	Code	P.M8	On	Off	On
A101SYWQ	SPDT	1	On	None	On			
A103SYWQ	SPDT	5	On	Off	On			
A201SYWQ	DPDT	2	On	None	On			
A203SYWQ	DPDT	6	On	Off	On			

SPDT/DPDT



A101SDZQ



A201SDZQ

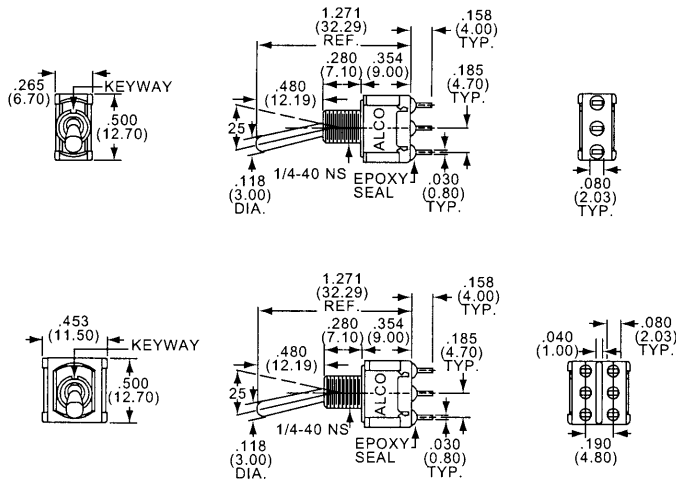

Model	Silver Contacts	Type	Act .	Code	P.M8	On	Off	On
A101SDZQ	SPDT	1	On	None	On			
A103SDZQ	SPDT	5	On	Off	On			
A201SDZQ	DPDT	2	On	None	On			
A203SDZQ	DPDT	6	On	Off	On			

Thomas & Betts

Quality & Innovation From **AUGAT**® Name Brand Products

C26

Thomas & Betts
8155 T&B Blvd.
Memphis, TN 38125
(901) 252-5000 FAX (901) 252-1380

"A" Series Toggles The Gemini Series

Refer to Pages C32-C36 for Additional Options

SEE PAGE C24 FOR PRODUCT SPECIFICATIONS

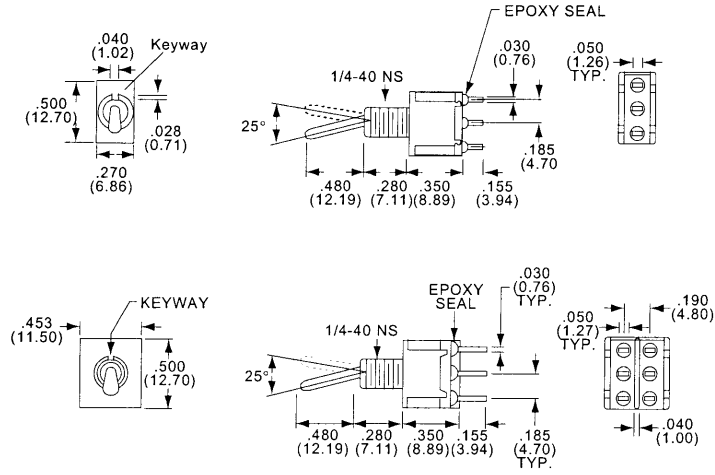

SPDT



A101SDCQ

DPDT

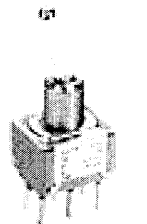

A201SDCQ

Silver Contacts Model	Type	Act. Code	P. M8			
A101SDCQ	SPDT	1		On	None	On
A103SDCQ	SPDT	5		On	Off	On
A201SDCQ	DPDT	2		On	None	On
A203SDCQ	DPDT	6		On	Off	On
A208SDCQ	DPDT	2		On	None	(On)

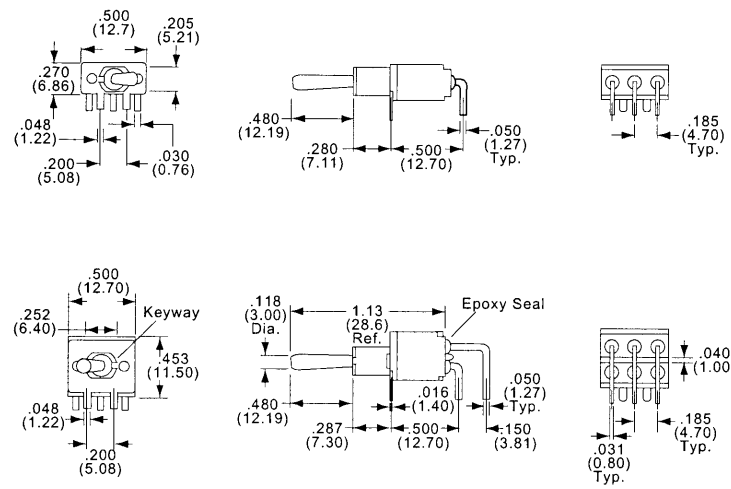

SPDT/DPDT



A101SD9AQ
Horizontal Actuation

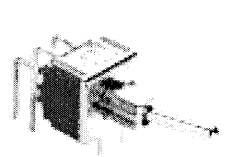

A201SD9AQ
Horizontal Actuation

Silver Contacts Model	Gold Contacts Model	Type	Act. Code	P. M8			
A101SD9AQ	A101SD9AB	SPDT	1		On	None	On
A103SD9AQ	A103SD9AB	SPDT	5		On	Off	On
A108SD9AQ		SPDT	1		On	None	(On)
A201SD9AQ	A201SD9AB	DPDT	2		On	None	On
A208SD9AQ	A208SD9AB	DPDT	2		On	None	(On)

Need more technical information?

Consult your Thomas & Betts sales office listed on the back cover

The Gemini Series "A" Series Toggles 5 Amp "Locking Actuator"

Refer to Pages C32-C36 for Additional Options

SEE PAGE C24 FOR PRODUCT SPECIFICATIONS

SPDT



A101SD9AV2Q
Vertical Actuation

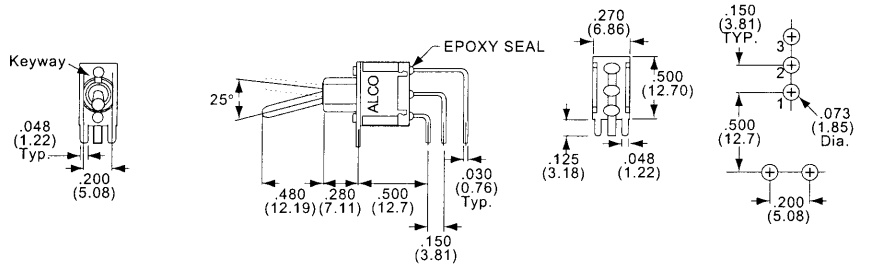

DPDT

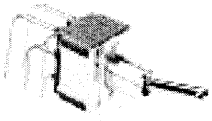

A201SD9AV2Q
Vertical Actuation

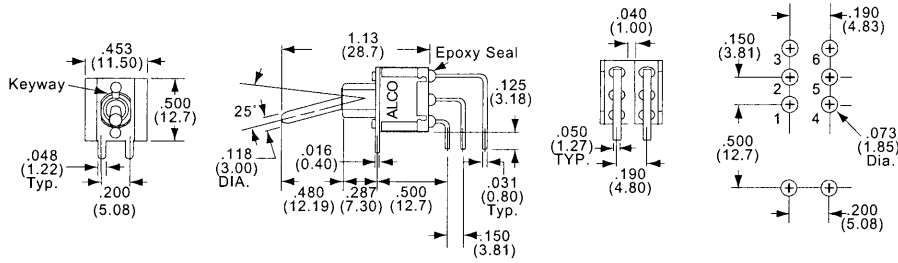

Model	Silver Contacts	Type	Act. Code	P. M8	On	None	On	Model	Silver Contacts	Type	Act. Code	P. M8	On	None	On
A101SD9AV2Q	2	SPDT	1		On	None	On	A201SD9AV2Q	2	DPDT	2		On	None	On
A103SD9AV2Q	5	SPDT	5		On	Off	On	A203SD9AV2Q	6	DPDT	6		On	Off	On
								A208SD9AV2Q	2	DPDT	2		On	None	(On)

SPDT



A101KZQ

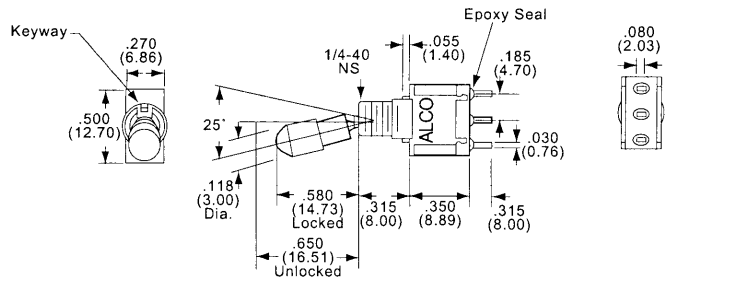

DPDT



A201KZQ

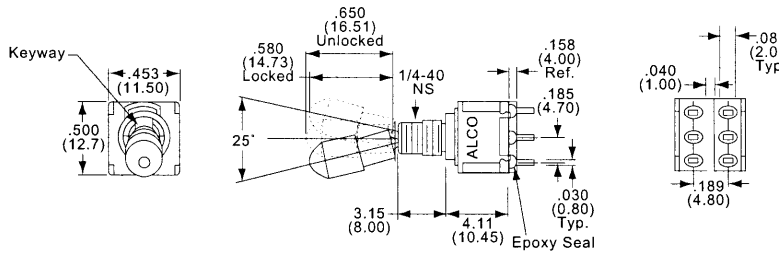

Model	Silver Contacts	Type	Act. Code	P. M8	On	None	On
A101KZQ	2	SPDT	1		On	None	On
A103KZQ	5	SPDT	5		On	Off	On

Model	Gold Contacts	Silver Contacts	Type	Act. Code	P. M8	On	None	On
A201KZB	2	A201KZQ	DPDT	2		On	None	On
A203KZB	6	A203KZQ	DPDT	6		On	Off	On
A205KZB	6	A205KZQ	DPDT	6		(On)	Off	(On)
A211KZB	11	A211KZQ	SP3T	11		On	On	On

Thomas & Betts

Quality & Innovation From **AUGAT** Name Brand Products

C28

Thomas & Betts
8155 T&B Blvd.
Memphis, TN 38125
(901) 252-5000 FAX (901) 252-1380

"A" Series Toggles Right Angle The Gemini Series

Refer to Pages C32-C36 for Additional Options

SEE PAGE C24 FOR PRODUCT SPECIFICATIONS

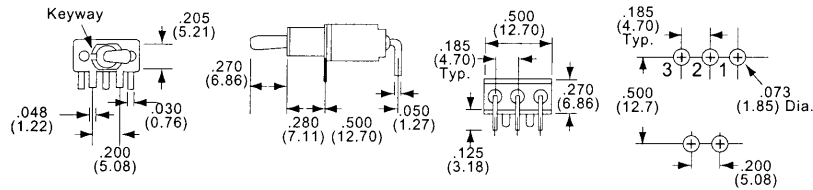

SPDT



A101MD9AQ
Horizontal Actuation

Silver Contacts Model	Gold Contacts Model	Type	Act. Code	P. M8			
A101MD9AQ	A101MD9AB	SPDT	1		On	None	On
A103MD9AQ	A103MD9AB	SPDT	5		On	Off	On
A108MD9AQ	A108MD9AB	SPDT	1		On	None	(On)

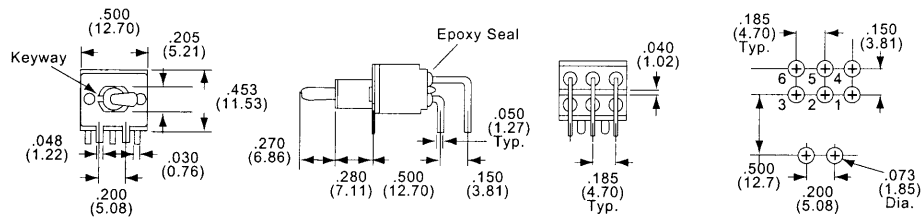

DPDT



A201MD9AQ
Horizontal Actuation

Silver Contacts Model	Gold Contacts Model	Type	Act. Code	P. M8			
A201MD9AQ	A201MD9AB	DPDT	2		On	None	On
A203MD9AQ	A203MD9AB	DPDT	6		On	Off	On

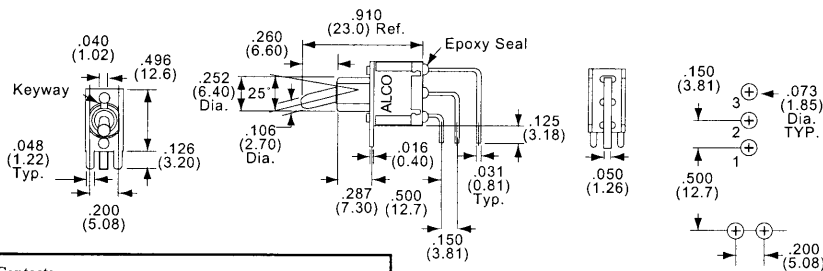

SPDT



A101MD9AV2Q
Vertical Actuation

Silver Contacts Model	Gold Contacts Model	Type	Act. Code	P. M8			
A101MD9AV2Q	A101MD9AV2B	SPDT	1		On	None	On
A103MD9AV2Q	A103MD9AV2B	SPDT	5		On	Off	On
A108MD9AV2Q	A108MD9AV2B	SPDT	1		On	None	(On)

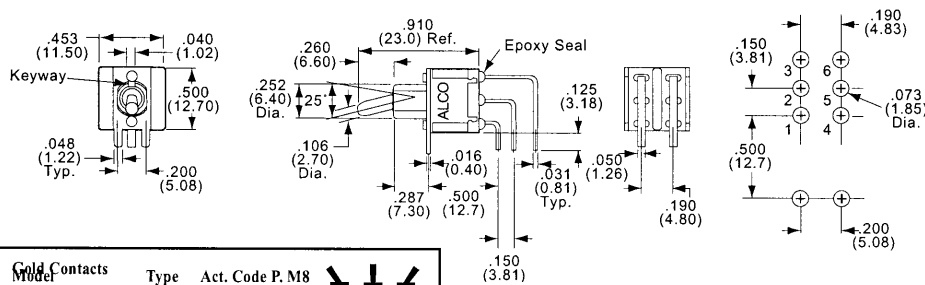

DPDT



A201MD9AV2AQ
Vertical Actuation

Silver Contacts Model	Gold Contacts Model	Type	Act. Code	P. M8			
A201MD9AV2Q	A201MD9AV2B	DPDT	2		On	None	On
A203MD9AV2Q	A203MD9AV2B	DPDT	6		On	Off	On
A208MD9AV2Q	A208MD9AV2B	DPDT	2		On	None	(On)

Need more technical information?

Consult your Thomas & Betts sales office listed on the back cover

The Gemini Series "A" Series Toggles Flat Actuators/Wire Lug

Refer to Pages C32-C36 for Additional Options

SEE PAGE C24 FOR PRODUCT SPECIFICATIONS

SPDT



A101P3YZQ

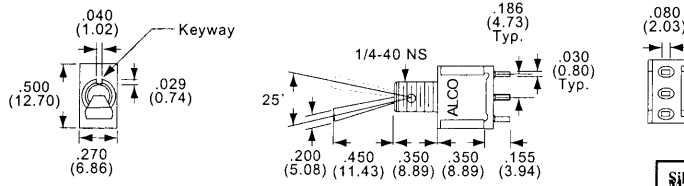

Model	Silver Contacts	Type	Act. Code	P.M.8	On	None	On
A101P3YZQ	SPDT	1	On	None	On		
A103P3YZQ	SPDT	5	On	Off	On		
A105P3YZQ	SPDT	5	(On)	Off	(On)		
A107P3YZQ	SPDT	5	On	Off	(On)		
A108P3YZQ	SPDT	1	On	None	(On)		

DPDT



A201P3YZQ

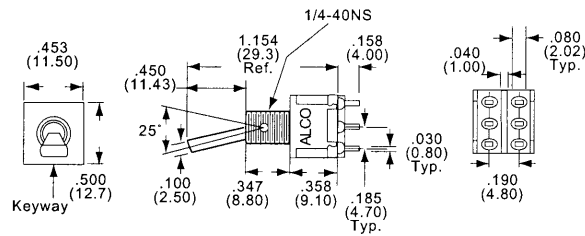

Model	Silver Contacts	Type	Act. Code	P.M.8	On	None	On
A201P3YZQ	DPDT	2	On	None	On		
A203P3YZQ	DPDT	6	On	Off	On		
A205P3YZQ	DPDT	6	(On)	Off	(On)		
A207P3YZQ	DPDT	6	On	Off	(On)		
A208P3YZQ	DPDT	2	On	None	(On)		
A211P3YZQ	SP3T	11	On	On	On		
A215P3YZQ	SP3T	11	(On)	On	(On)		

SPDT

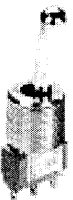

A101TZQ

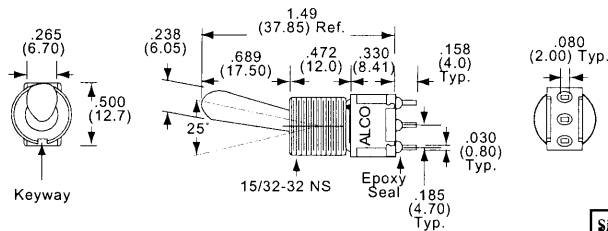

Model	Silver Contacts	Type	Act. Code	P.M.8	On	None	On
A101TZQ	SPDT	1	On	None	On		
A103TZQ	SPDT	5	On	Off	On		

DPDT



A201TZQ

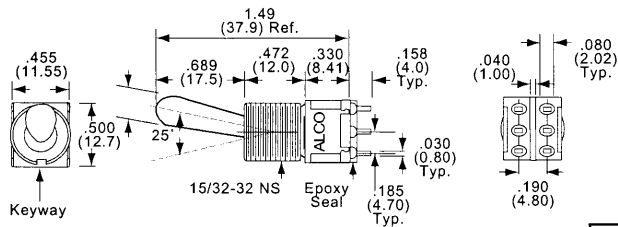

Model	Silver Contacts	Type	Act. Code	P.M.8	On	None	On
A201TZQ	DPDT	2	On	None	On		
A203TZQ	DPDT	6	On	Off	On		
A211TZQ	SP3T	11	On	On	On		

Thomas & Betts

Quality & Innovation From **AUGAT**® Name Brand Products

C30

Thomas & Betts
8155 T&B Blvd.
Memphis, TN 38125
(901) 252-5000 FAX (901) 252-1380

"A" Series Toggles 15/32 Bushing The Gemini Series

Refer to Pages C32-C36 for Additional Options

SEE PAGE C24 FOR PRODUCT SPECIFICATIONS

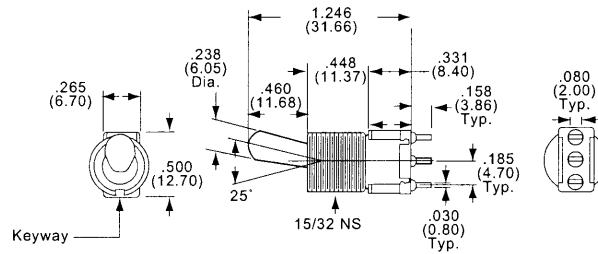

SPDT



A103T1ZQ

Model	Contacts	Type	Act. Code	P. M8				
A101T1ZQ	SPDT	1	On	None	On			
A103T1ZQ	SPDT	5	On	Off	On			
A105T1ZQ	SPDT	5	(On)	Off	(On)			
A108T1ZQ	SPDT	1	On	None	(On)			

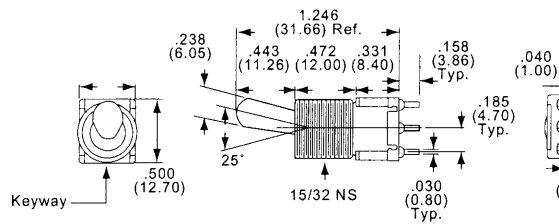

DPDT

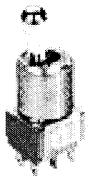

A201T1ZQ

Model	Contacts	Type	Act. Code	P. M8				
A201T1ZQ	DPDT	2	On	None	On			
A203T1ZQ	DPDT	6	On	Off	On			
A205T1ZQ	DPDT	6	(On)	Off	(On)			
A207T1ZQ	DPDT	6	On	Off	(On)			
A208T1ZQ	DPDT	2	On	None	(On)			
A211T1ZQ	SP3T	11	On	On	On			

Need more technical information?

Consult your Thomas & Betts sales office listed on the back cover

122
108

The Gemini Series "A" Series Miniature Toggles

FEATURES

Hardware supplied with threaded bushings: two hex nuts, one internal tooth lockwasher and one locking ring. (See Hardware Section for: dress nuts, plastic caps and environment boot seals.)

TYPICAL PERFORMANCE CHARACTERISTICS:

Contact RatingSilver: 2 A @ 250 VAC or 5 A @ 125 VAC
 Gold: 0.4 VA @ 20 VAC/DC max.
 Insulation Resistance1,000 Megohms min. @ 500 VDC.
 Dielectric Strength1,000 Volts RMS @ sea level initial
 Electrical Life30,000 Cycles

ENVIRONMENTAL SPECIFICATIONS

Operating Temperature -20°C to + 85°C (-4°F to + 185°F)
 Storage Temperature.....-45°C to + 100°C (-49°F to + 212°F)



DESIGN

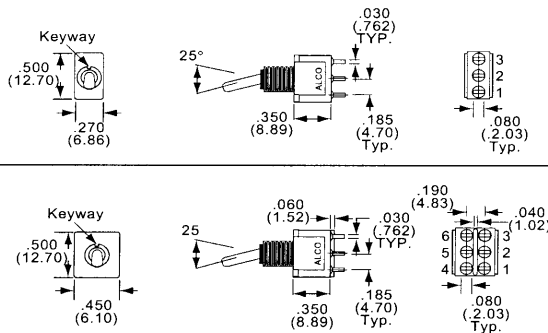
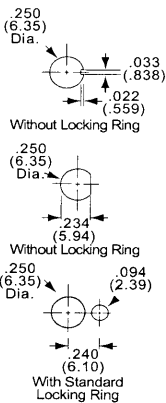
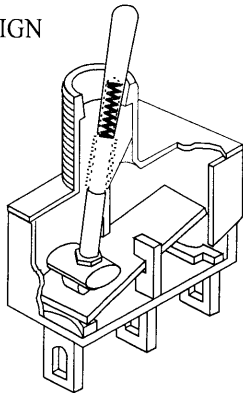

PART NUMBERING

Model	Function	Toggle	Bushing	Terminal	Contact	K, K1: Cap Color	Option
A1 Single Pole	<ul style="list-style-type: none"> S Bat. Long K Locking K1 Locking L Lever L1 Lever L2 Lever M Bat. Short Flatted (with \checkmark only) P3 Flatted (with \checkmark only) P4 Flatted (with \checkmark only) T Large Toggle & Bushing T1 Large Toggle & Bushing T2P Large Flatted Toggle and Bushing 	<ul style="list-style-type: none"> Y 1/4-40 threaded, .35" long, slotted Y9 unthreaded, .35" long CW 1/4-40 threaded, .37" long, actuator & bushing flange environmental seals D 1/4-40 threaded, .28" long D9 1/4-40 threaded, flanged, .30" long H 	<ul style="list-style-type: none"> Z Wire Lug A Right Angle AV2 Vertical Right Angle Printed Circuit C Vertical Support V30 V40 V90 Bracket V60 V70 V80 Wire Wrap W W1 W3 W4 W5 Z3 	<ul style="list-style-type: none"> Q Silver B Gold over Silver G 	<ul style="list-style-type: none"> U Black Z Red 	<ul style="list-style-type: none"> U.L. (Q or G contact only) 	
A2 Double Pole							
01 On-On							
03 On-Off-On							
05 (On)-Off-(On)							
07 On-Off-(On)							
08 On-(On)							
11 On-On-On							
13 On-On-(On)							
15 (On)-On-(On)							

See page C33 for SP3T wiring diagram.

See pages M2-M4 for application specific indexing.

Other Options

- N** Black finish toggle, bushing and hardware. Add "N" to end of part number, but before U.L. option.
- O** Internal O-ring environmental actuator seal. Add letter after toggle option: S,M,L,L1 & L2.
- P** Anti-Push-In/Anti rotate. Add letter after toggle S,M,L,L1 & L2

Note: For surface mount termination, use the "TST" series, Page C8

Thomas & Betts

Quality & Innovation From **AUGAT** Name Brand Products

C32

Thomas & Betts
 8155 T&B Blvd.
 Memphis, TN 38125
 (901) 252-5000 FAX (901) 252-1380

"A" Series Miniature Toggles The Gemini Series

FUNCTIONS

The following functions available in SP or DP.

01	2 Positions	None indicates no mechanical position		On	None	On
03	3 Positions			On	Off	On
05	3 Positions	Off indicates a mechanical position with no electrical connection.(On)		Off	(On)	
07	3 Positions			(On)	Off	On
08	2 Positions	(On) indicates momentary action.		(On)	None	On
		SPDT, connect terminals:				
		DPDT, connect terminals:				
11	3 Positions			On	On	On
13	3 Positions			(On)	On	On
15	3 Positions			(On)	On	(On)
Functions available in DP only				Connect terminals:		

* SP3T functions achieved with external jumper installed by customer

WIRING DIAGRAM FOR FUNCTIONS

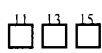

Pos. 3
Pos. 2
Pos. 1

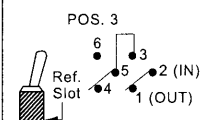
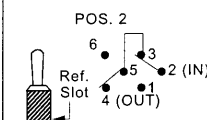
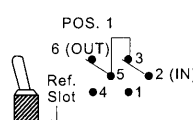
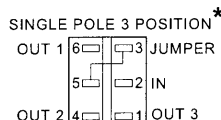
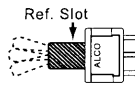

TOGGLES



Dimension "L"	Bushing Type	Dimension "L"	Bushing	"B" Actuator	"A" Dimension
.410 (10.41)	"Y", "H", "CW"	.200 (5.08)	"Y", "H"	P3 (5.08)	.450 (11.43)
.480 (12.19)	"D", "D9" "CW"	.270 (6.86)	"D", "D9"	P4 (4.19)	.250 (6.35)



Large Toggle/
Bushing

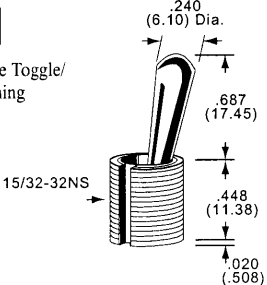

Large Toggle/
Bushing

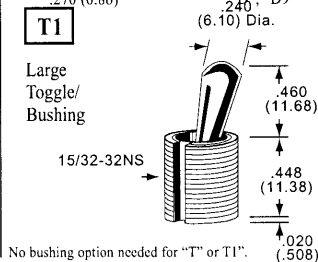

Locking

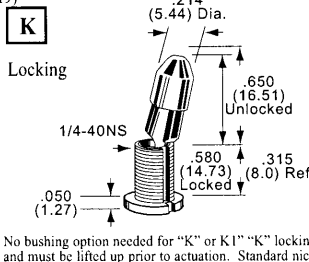

Locking

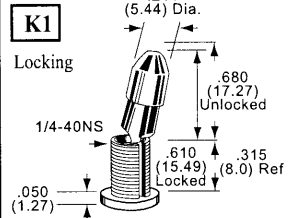

Need more technical information?

Consult your Thomas & Betts sales office listed on the back cover



The Gemini Series "A" Series Miniature Toggles "Bushing / Terminal Options"

TOGGLES

L
Lever

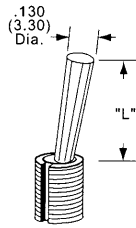

L1
Lever

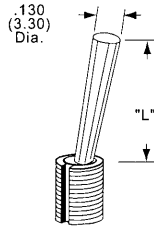

L2
Lever

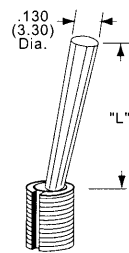

Dimension "L"	Bushing
.840 (21.34)	"Y", "H" "CW"
.910 (23.4)	"D", "D9"

Dimension "L"	Bushing Type
.640 (16.26)	"Y", "H" "CW"
.710 (18.03)	"D", "D9"

Dimension "L"	Bushing Type
.550 (13.97)	"Y", "H"
.620 (15.75)	"D", "D9"

BUSHINGS

Y
1/4-40 Thread
.35" long, slotted
(Standard)

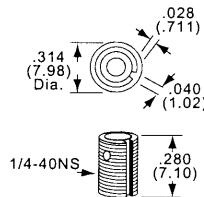

D9
Unthreaded
.28" long

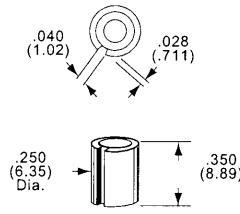

Used with
Z, C & W
terminations

H

1/4-40 Thread
Flanged, .30" long

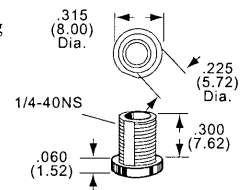

D
1/4-40 Thread
.28" long, slotted

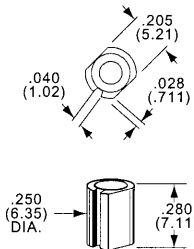
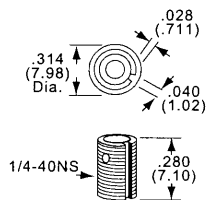

Used with
A, AV2, V30
V80 & V90
terminations

CW

Threaded
Splashproof

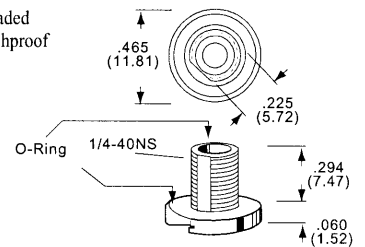

For S & M Toggles

TERMINALS

Z
Wire Lug

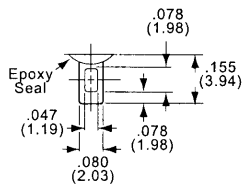

Z
Quick Connect

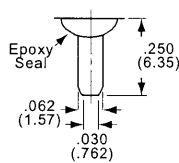

Mates with AMP
61454 or 60900.

W W1 W3 W4 W5
Wire Wrap

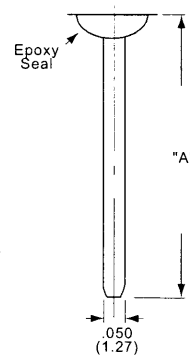

	"A"
W	.750
W1	.964
W3	.425
W4	1.062
W5	1.305

C
Printed Circuit

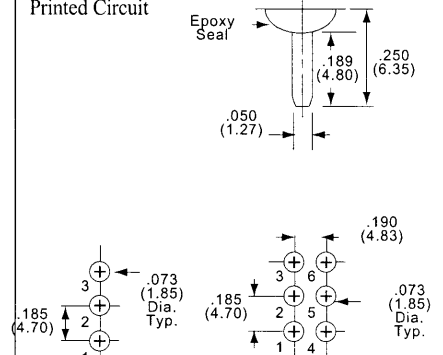

Single pole

Double pole

Thomas & Betts

Quality & Innovation From **AUGAT** Name Brand Products

C34

Thomas & Betts
8155 T&B Blvd.
Memphis, TN 38125
(901) 252-5000 FAX (901) 252-1380

"A" Series Miniature Toggles The Gemini Series

TERMINALS

A

**Right Angle
Single Pole**

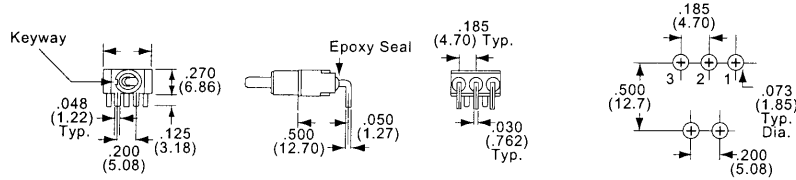

Note: Terminal numbers viewed from top of P.C. boards.

A

**Right Angle
Double Pole**

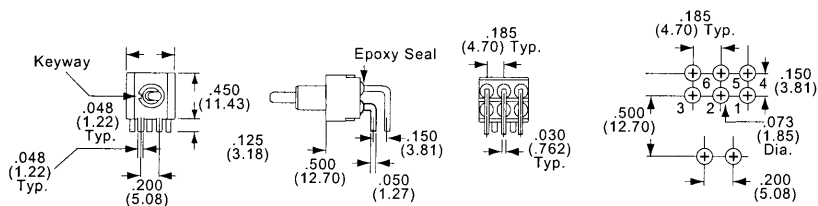

Note: Terminal numbers viewed from top of P.C. boards.

AV2

**Vertical Right Angle
Single Pole**

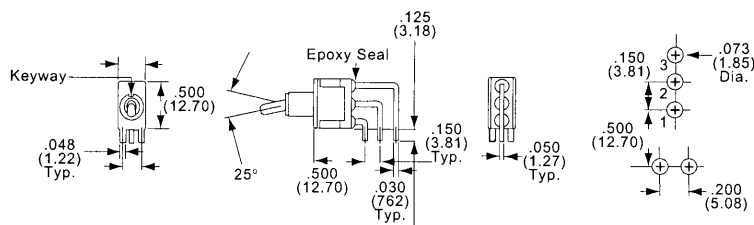

Note: Terminal numbers viewed from top of P.C. boards.

AV2

**Vertical Right Angle
Double Pole**

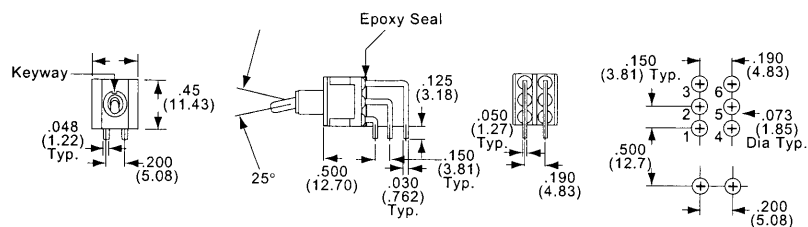

Note: Terminal numbers viewed from top of P.C. boards.

Need more technical information?

Consult your Thomas & Betts sales office listed on the back cover

C35

Thomas & Betts
8155 T&B Blvd.
Memphis, TN 38125
(901) 252-5000 FAX (901) 252-1380

C

The Gemini Series "A" Series Miniature Toggles "5 Amp" Terminal Options

TERMINALS NOTE: Terminal numbers viewed from top of P.C. board

V30 V40 V90
Vertical Support Bracket
Single Pole

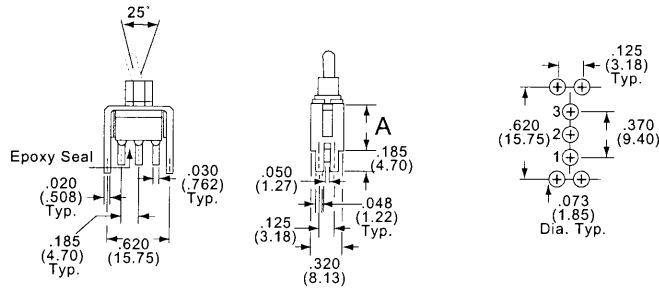

Option Code	Dim. "A"
V30	.460 (11.68)
V40	.630 (16.00)
V90	1.150 (29.21)

Vertical Support Bracket
Double Pole

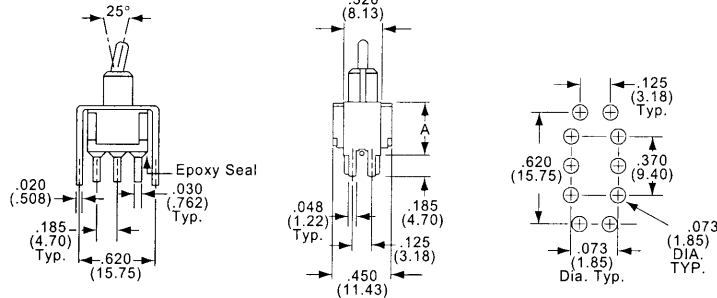

Option Code	Dim. "A"
V30	.460 (11.68)
V40	.630 (16.00)
V90	1.150 (29.21)

V60 V70 V80
Vertical Support Bracket
Single Pole

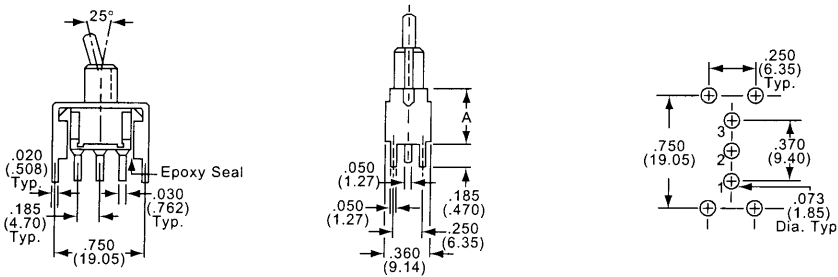

Option Code	Dim. "A"
V60	.460 (11.68)
V70	.630 (16.00)
V80	.953 (24.71)

Vertical Support Bracket
Double Pole

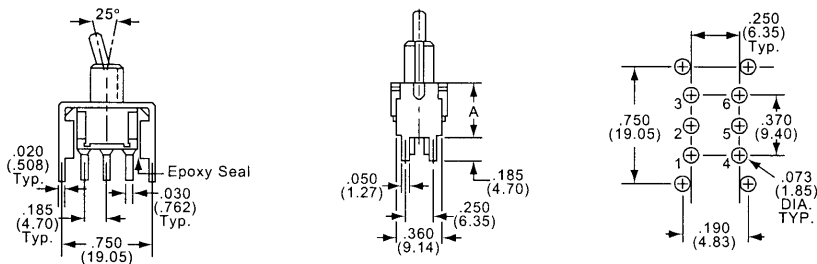

Option Code	Dim. "A"
V60	.460 (11.68)
V70	.630 (16.00)
V80	.953 (24.71)

CONTACTS

B CONTACTS: Copper alloy with gold plate, welded button.

TERMINALS: Brass with gold plate.

ELECTRICAL RATING: 0.4 VA @ 20 VAC/DC.

Q CONTACTS: Copper alloy with silver, welded button.

TERMINALS: Brass with tin/lead plate.
ELECTRICAL RATING: 5 A @ 250 VAC, 5 A @ 28 VDC.

UL/CSA RATING: 5A @ 125 VAC, 3A @ 250 VAC.
(Specify "UL" option code)

G CONTACTS: Copper alloy with gold plate over silver, welded button.

TERMINALS: Brass alloy, with gold plate.

Note: This contact option can be used for low-level or power switching. If level is above removal of gold plate, the switch is rendered unusable only for power switching due to arc.

UL/CSA RATING: 5A @ 125 VAC, 3A @ 250 VAC
(Specify "UL" option code)

ELECTRICAL RATING: 0.4 VA @ 20 VAC/DC or 5 A @ 125 VAC, 2 A @ 250 VAC, 5 A @ 28 VDC.

Thomas & Betts

Quality & Innovation From **AUGAT** Name Brand Products

C36

Thomas & Betts
8155 T&B Blvd.
Memphis, TN 38125
(901) 252-5000 FAX (901) 252-1380