

## JPS350 Series

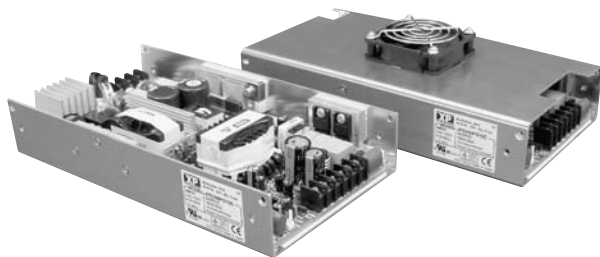

- 300 W with Convection Cooling
- High Efficiency - Up to 90%
- Meets EN61000-3-2, -3
- Meets 1U, Low Profile Requirements
- Zero Voltage Switching Technology
- AC OK & DC OK Signals
- Current Sharing

## Specification

## Input

Input Voltage	• 85-264 VAC (170-370 VDC)
Input Frequency	• 47-63 Hz
Input Current	• 4 A max at 115 VAC, 2 A max at 230 VAC
Inrush Current	• 30 A at 115 VAC, 60 A at 230 VAC
Power Factor	• 0.99 typical
Earth Leakage Current	• 2.0 mA max 264 VAC/60Hz
Input Protection	• Internal 6.3 A, 250 V fuse

## Output

Output Voltage	• See table
Output Voltage Trim	• $\pm 10\%$ single output models only
Initial Set Accuracy	• $\pm 1\%$
Minimum Load	• No minimum load required on single output models. For multi output models see note 5
Start Up Delay	• 2 s typical
Start Up Rise Time	• 100 ms typical
Hold Up Time	• 20 ms min at low line
Line Regulation	• $\pm 0.5\%$
Load Regulation	• $\pm 1\%$ for single output models and V1 & V2 of multi output models $\pm 5\%$ for V3 & V4
Tolerance	• $\pm 1\%$
Transient Response	• 4% max. deviation, 500 $\mu$ s recovery time for a 25% load change
Ripple & Noise	• $\pm 1\%$ max pk-pk, 20 MHz BW
Overvoltage Protection	• 115-140%, recycle input to reset
Overtemperature Protection	• Shuts down at 110 $^{\circ}$ C, auto recovery
Overload Protection	• 120-150%, auto recovery
Short Circuit Protection	• Trip and restart (Hiccup mode)
Temperature Coefficient	• 0.05% / $^{\circ}$ C
Remote Sense	• Compensates for up to 0.5 V drop
Remote On/Off	• On = Logic High or Open Off = Logic Low or Short
Current Share	• Single wire current sharing (4 supplies can be paralleled)
Fan Output	• 12 V model: 300 mA 5 V model (JPS350PS05): 400 mA

## General

Efficiency	• Up to 90%
Isolation	• 3000 VAC Input to Output 1500 VAC Input to Ground 500 VAC Output to Ground
Switching Frequency	• 120 kHz typical for PFC and PWM
Power Density	• 4.96 W/In <sup>3</sup>
Signals	• AC OK, DC OK and Remote On/Off (see control and supervisory signals)
MTBF	• 100 kHrs per MIL-HDBK-217F

## Environmental

Operating Temperature	• 0 $^{\circ}$ C to +70 $^{\circ}$ C, (see derating curve) Full power to +50 $^{\circ}$ C
Cooling	• 350 W with 18 CFM airflow 300 W convection cooling
Operating Humidity	• 5-95% RH, non-condensing
Storage Temperature	• -20 $^{\circ}$ C to +85 $^{\circ}$ C
Operating Altitude	• 3000 m
Vibration	• 2 G, 10 Hz to 500 kHz, 10 mins/cycle for 60 mins each axis

## EMC &amp; Safety

Emissions	• EN55022, level B conducted FCC 20780, level B conducted
Harmonic Currents	• EN61000-3-2
Voltage Flicker	• EN61000-3-3
ESD Immunity	• EN61000-4-2, level 3 Perf Criteria A
Radiated Immunity	• EN61000-4-3, 10 V/m Perf Criteria A
EFT/Burst	• EN61000-4-4, level 3 Perf Criteria B
Surge	• EN61000-4-5, level 3 Perf Criteria B
Safety Approvals	• EN60950, UL1950, CSA C22.2 No. 234, CE Mark LVD

## Models and Ratings

# JPS350 - Single Output XP

Output Power	Output Voltage	Output Current		Ripple & Noise Pk-Pk <sup>(2)</sup>	Model Number <sup>(1)</sup>
		Convection Cooled	18 CFM		
350 W	5 V	54.0 A	63.0 A	50 mV	JPS350PS05C †
	12 V	25.0 A	30.0 A	120 mV	JPS350PS12C †
	15 V	20.0 A	24.0 A	120 mV	JPS350PS15C †
	24 V	13.0 A	15.0 A	200 mV	JPS350PS24C †
	48 V	6.5 A	7.3 A	200 mV	JPS350PS48C †

### Notes

- For non-current share version delete suffix 'C' from model number.
- Ripple and noise measured over 15 MHz bandwidth with a 47 µF electrolytic capacitor and 0.47 µF ceramic capacitor.

† Available from Farnell InOne.

\*Available from Newark InOne.

## Mechanical Details

All dimensions are in inches (mm)  
Tolerance: ± 0.03 (0.8) max.

Weight: 2.12 lbs (960 g) approx.

### All models (except JPS350PS05)

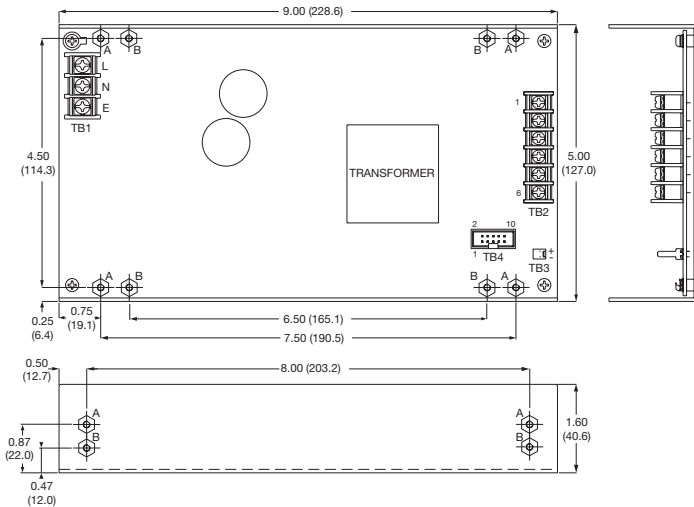

PIN CONNECTIONS			
Pin	TB2		TB4
	JPS350PS05	All other models	All models
1	+5 V	+V	N/C
2	+5 V	+V	N/C
3	0 V	+V	+Remote sense
4	0 V	0 V	DC OK
5	0 V	0 V	-Remote sense
6	0 V	0 V	N/C
7	+5 V		Current Share <sup>(1)</sup>
8	+5 V		Remote On/Off
9			AC OK
10			0 V

### Notes:

- For non 'C' models pin 7 is not used.
- TB3 is for fan, with Molex 5045-02A or equivalent.
- TB1 (AC input) and TB2 (DC output) are terminal blocks.
- TB4 signal connector is Molex 70246-10 or equivalent.
- Maximum mounting screw penetration is 0.16 (4.0)
- Fan/Cover option available, order part number:  
5 V models: JPS350F/CVR5V†  
All other models: JPS350F/CVR†  
Alternatively, add suffix '-E' to model number to receive cover fitted to the unit 4.95 x 8.92 2.48 (127.0 x 228.6 x 63.7).

### Fixing Holes:

- A = #6-32 screw mounting holes
- B = M3 x 0.5 screw mounting holes

### JPS350PS05

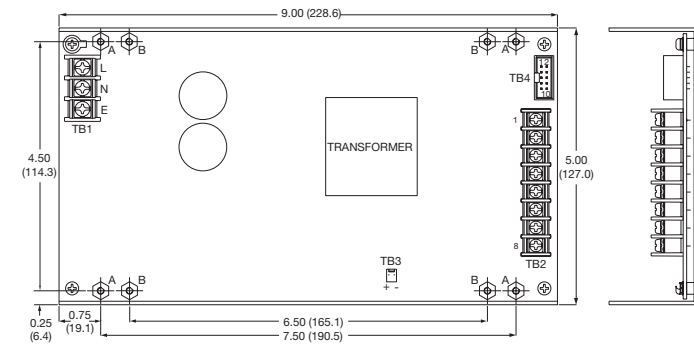

## Application Notes

### Derating Curve

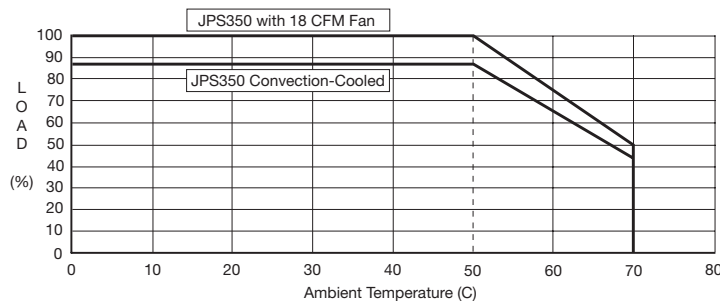

### Signals

- To turn off the output, apply 5 V to the Remote On/Off.
- AC OK is a TTL signal which goes LOW when input falls below 60 VAC at rated load.
- DC OK is a TTL signal which goes LOW when PSU is in an overcurrent condition, overvoltage condition, disabled or when output falls out of regulation.
- For AC OK and DC OK signals, source current is 1 mA, sink current is 6 mA.

## Models and Ratings

Output 1			Output 2			Output 3			Output 4			Model Number
Output V1	Conv. Cooled	Max 18 CFM	Output V2	Conv. Cooled	Max 18 CFM	Output V3	Conv. Cooled	Max 18 CFM	Output V4	Conv. Cooled	Max 18 CFM	
3.3 V	20 A	35 A	5 V	20 A	35 A	12 V	4.5 A	6 A	-12 V	1.0 A	3 A	JPS350PQ46 <sup>(2)</sup>
5.0 V	25 A	35 A	12 V	10 A	14 A	-12 V	2.0 A	3 A	-5 V	1.0 A	2 A	JPS350PQ41
5.0 V	25 A	35 A	12 V	6 A	8 A	24 V	3.0 A	4 A	-12 V	2.0 A	3 A	JPS350PQ47
5.0 V	25 A	35 A	15 V	5 A	7 A	24 V	3.0 A	4 A	-15 V	1.6 A	3 A	JPS350PQ48

### Notes

- Maximum power is 350 W with 18 CFM forced air or 300 W with convection cooling.
- JPS350PQ46 requires 22 CFM max. OVP on V2 (5 V output) not V1.
- For current share option add suffix 'C' to model number.
- Current share models are built to order.
- All models require 2 A minimum load on V1. On V2, JPS350PQ46 requires 1 A, PQ41 requires 0.5 A and PQ47/48 requires 2 A.

## Mechanical Details

All dimensions are in inches (mm)  
Tolerance: ± 0.03 (0.8) max.

Weight: 2.12 lbs (960 g) approx.

### JPS350PQ41/47/48

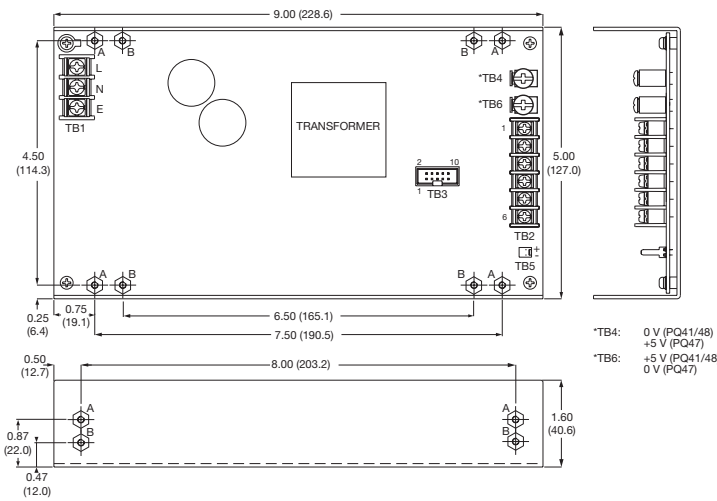

PIN CONNECTIONS - TB3				
Pin	PQ41	PQ46	PQ47	PQ48
1	+5 V +S	+3.3 V +S	+5 V +S	+5 V
2	+5 V PS <sup>(6)</sup>	N/C	+5 V PS <sup>(6)</sup>	+5 V
3	+12 V +S	+3.3 V PS <sup>(6)</sup>	+12 V +S	+15 V
4	DC OK	DC OK	DC OK	DC OK
5	+12 V -S	+5 V +S	+12 V -S	+15 V
6	+5 V -S	+3.3 V -S	+5 V -S	+5 V
7	+12 V PS <sup>(6)</sup>	+5 V PS <sup>(6)</sup>	+12 V PS <sup>(6)</sup>	+15 V PS <sup>(6)</sup>
8	Remote On/Off	Remote On/Off	Remote On/Off	Remote On/Off
9	AC OK	AC OK	AC OK	AC OK
10	0 V	0 V	0 V	0 V

PIN CONNECTIONS - TB2				
Pin	PQ41	PQ46	PQ47	PQ48
1	-12 V	0 V	-12 V	-15 V
2	-5 V	+12 V	+24 V	+24 V
3	0 V	-12 V	0 V	0 V
4	0 V	0 V	0 V	0 V
5	0 V		0 V	0 V
6	+12 V		+12 V	+15 V

### JPS350PQ46

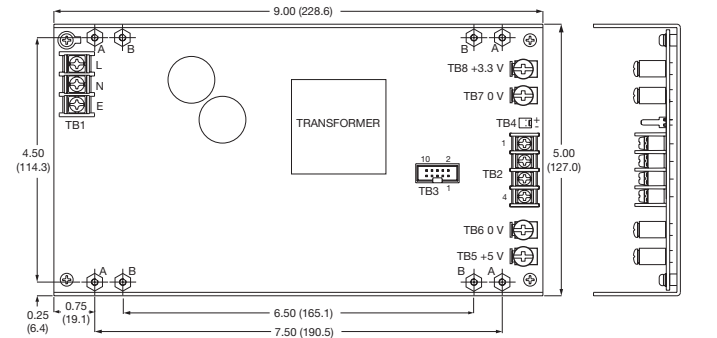

### Notes:

- TB5 (PQ41/47/48) and TB4 (PQ46) is for fan with Molex 5045-02A or equivalent.
- TB1 (AC input) and TB2 (DC output) are terminal blocks.
- TB3 signal connector is Molex 70246-10 or equivalent.
- Maximum mounting screw is 0.16 (4.0).
- Fan/Cover option available, order part number:  
PQ41, PQ46: JPS350F/CVR† PQ48 & PQ47: JPS350F/CVR24  
Alternatively, add suffix '-E' to model number to receive cover fitted to the unit.
- PS - Single wire parallel on 'C' models only.  
No connection on standard models.

### Fixing Holes:

- A = #6-32 screw mounting holes
- B = M3 x 0.5 screw mounting holes

## Application Notes

### Derating Curve

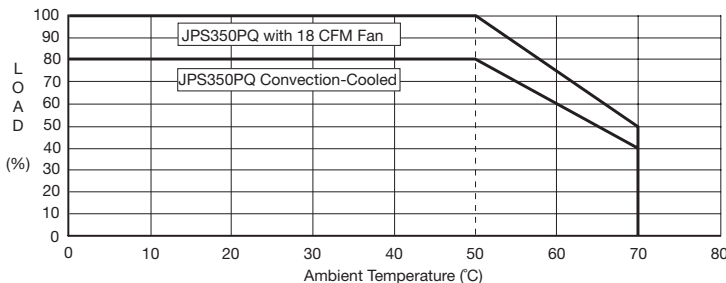

### Signals

- To turn off the output, apply 5 V to the remote On/Off.
- AC OK is a TTL signal which goes LOW when input falls below 60 VAC at rated load.
- DC OK is a TTL signal which goes LOW when PSU is in an overcurrent condition, overvoltage condition, disabled or when output falls out of regulation.
- For AC OK and DC OK signals, source current is 1 mA, sink current is 6 mA.

# Control & Supervisory Signals

JPS350 XP

## AC OK Signal

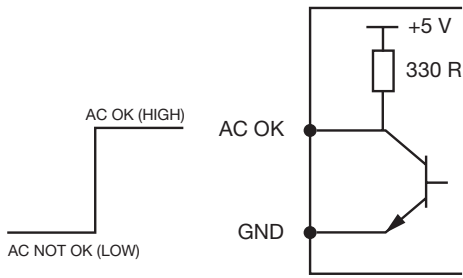

## DC OK Signal

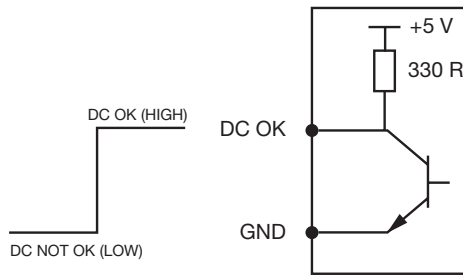

## Remote On/Off Control (Inhibit)

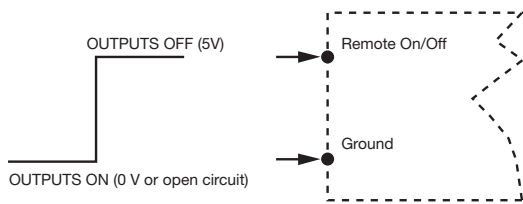

## Parallel Connection Utilizing Optional Current Share

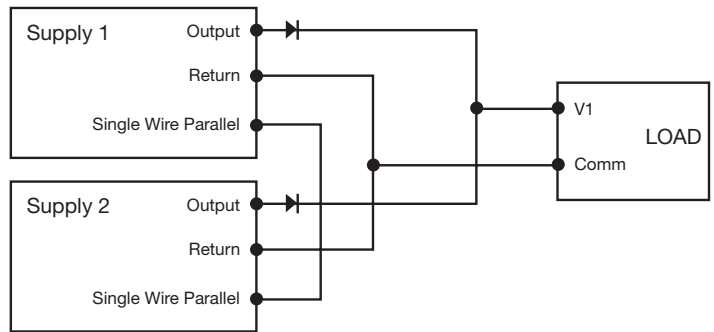

## Remote Sense Connection

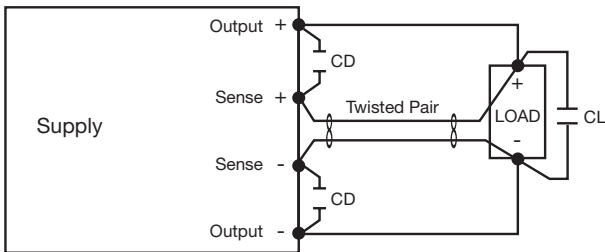

- Notes:
1. CD is 0.1  $\mu$ F ceramic capacitor.
  2. CL is 47  $\mu$ F electrolytic capacitor.

## JPS350 Fan/Cover Option

See mechanical details notes for information on how to order.

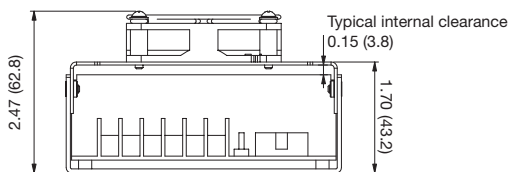
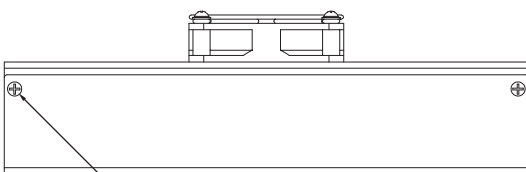
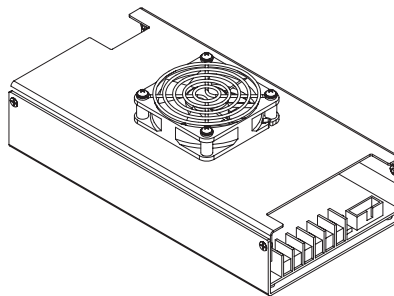
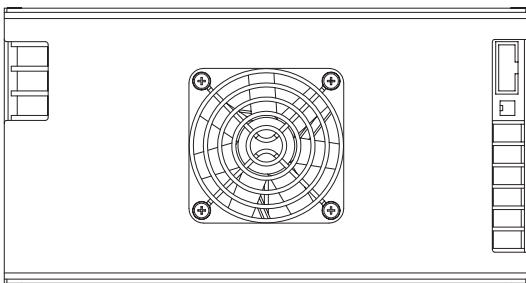

4 x M3 x 6 C/S head fixing screws in existing countersunk holes