

ANTENNA PRODUCTS

DATA SHEET

GPS Active Antenna (13*13*7 mm)

2008, June Rev.2

GPS active antenna (13*13*7 mm)				CAN 431343486158 1B				—	1	March, 07	
								▶	2	June, 08	
								—	3		
BY / 製定者	Sunwiun Hu	SUPER / 原圖編號	C.T.Lee	TLL. SH/ 共頁	12	PAGE/ 頁	1	SH nr.	—	4	
CHECK				DATE / 日期	June.,2008			—	5		

**GPS ACTIVE ANTENNA
FOR GLOBAL POSITIONING SYSTEMS (1.575G Hz)**

Product Specification

Ceramic Patch Antenna

Outline Dimension:	12*12*4 mm (Ceramic Patch)
Ground Plane	12*12*0.15 mm
Central Frequency	1575 +/- 3MHz
Impedance	50 Ohm
Gain	0 dBi (Elevation 90 degree)
VSWR	2.0 max
Polarization	Right Hand Circular Polarization
Axis Ratio	3 dB max. (Elevation 90 degree)

LNA

Central Frequency	1575 +/- 3 MHz
Gain	17 +/- 1 dB (at f _c , without SAW filter)
Noise Figure	1.5 dB typ. (at f _c , 1.8dB Max)
Output VSWR	2.0 (at f _c)
Supply Voltage	3.3 + /- 5% V
Current Consumption	6 mA
Output Impedance	50 Ohm
Operating Temperature/Humidity	-30 - +85 °C ; < 95%
Storage Temperature	-40 - +125 °C

GPS active antenna (13*13*7 mm)				CAN 431343486158 1B				—	1	March, 07	
								▶	2	June, 08	
								—	3		
BY / 製定者	Sunwiun Hu	SUPER / 原圖編號	C.T.Lee	TLL. SH/ 共頁	12	PAGE/ 頁	2	SH nr.	—	4	
CHECK				DATE / 日期	June.,2008			—	5		

Description:

Yageo provides an ideal active GPS antenna for your embedded system applications. With 13 x 13 x 7.5 mm in size, it best fit into your GPS system with maximum performance.

Key Features:

- Small form factor: 13 x 13 x 7.5 mm
- Lead-Free – RoHS/WEEE compliant
- High gain up to 17 dB
- Low power consumption
- I-Pex, Herose, MMCX connector are available.

Applications:

- Handheld devices
- Automotive and Marine Navigation
- Automotive Navigator Tracking
- Emergency Locator
- Geographic Surveying
- Personal Positioning
- Sporting and Recreation
- Embedded applications: PDA, DSC, Smart phone, UMPC, PND, MP4



GPS active antenna (13*13*7 mm)				CAN 431343486158 1B				—	1	March, 07	
								▶	2	June, 08	
								—	3		
BY / 製 定 者	Sunwiun Hu	SUPER / 原 圖 編 號	C.T.Lee	TLL. SH/ 共 頁	12	PAGE/ 頁	3	SH nr.	—	4	
CHECK				DATE / 日期	June.,2008			—	▶	5	

Antenna Return Loss and Impedance (with 30 * 30 mm square Ground Plane)

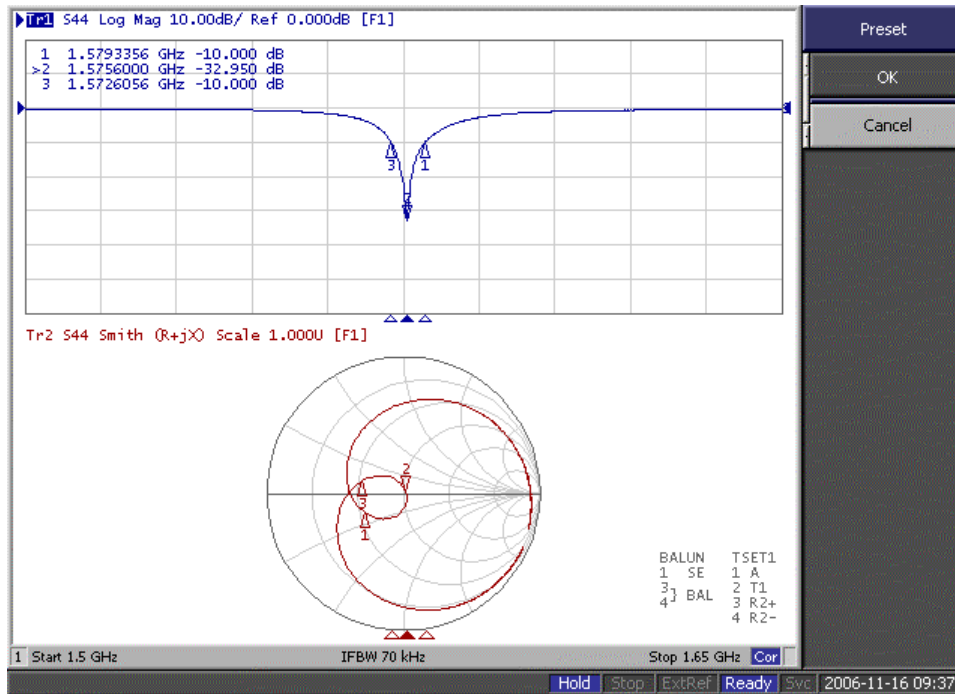

GPS active antenna (13*13*7 mm)				CAN 431343486158 1B				▶	1	March, 07	
								▶	2	June, 08	
								▶	3		
BY / 製定者	Sunwiun Hu	SUPER / 原圖編號	C.T.Lee	TLL. SH/ 共頁	12	PAGE/ 頁	4	SH nr.	▶	4	
CHECK				DATE / 日期	June.,2008			▶	5		

2D Circular gain measurement (with 30 *30 mm square Ground Plane)

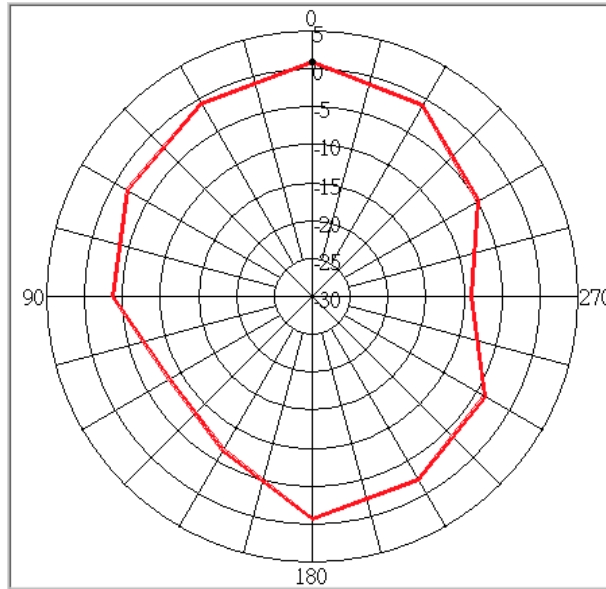

Circular gain 2D x-z plane pattern

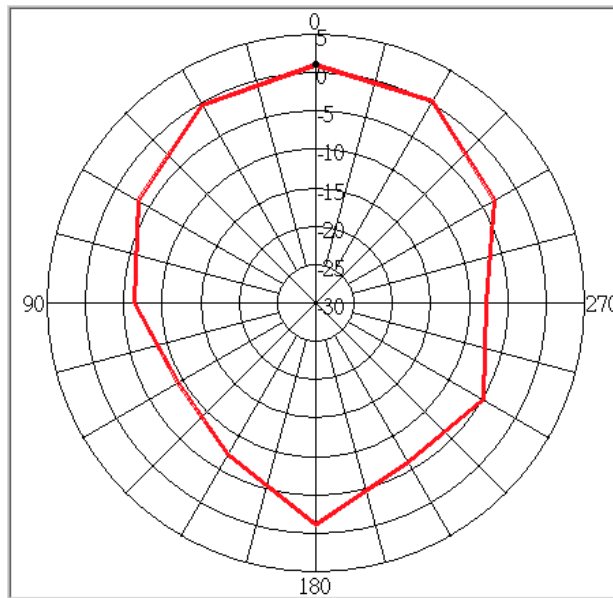

Circular gain 2D y-z plane pattern

GPS active antenna (13*13*7 mm)				CAN 431343486158 1B				—	1	March, 07	
								▶	2	June, 08	
								—	3		
BY / 製定者	Sunwiun Hu	SUPER / 原圖編號	C.T.Lee	TLL. SH/ 共頁	12	PAGE/ 頁	5	SH nr.	—	4	
CHECK				DATE / 日期	June.,2008			—	▶	5	

3D Circular gain measurement

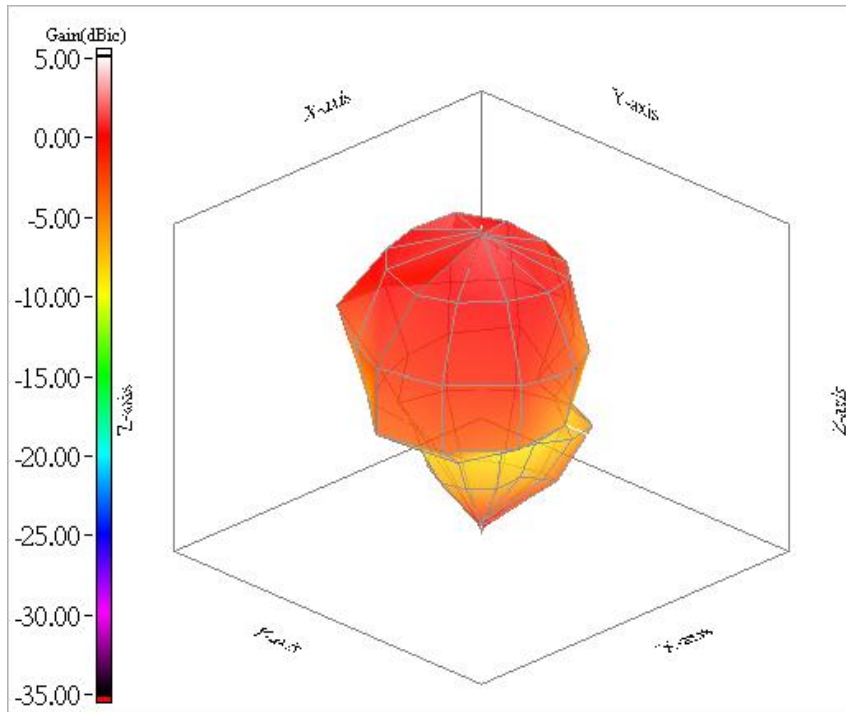

GPS active antenna (13*13*7 mm)				CAN 431343486158 1B				—	1	March, 07	
								▶	2	June, 08	
								—	3		
BY / 製定者	Sunwiun Hu	SUPER / 原圖編號	C.T.Lee	TLL. SH/ 共頁	12	PAGE/ 頁	6	SH nr.	—	4	
CHECK				DATE / 日期	June.,2008			—	5		

Circular gain 2D pattern for AR measurement

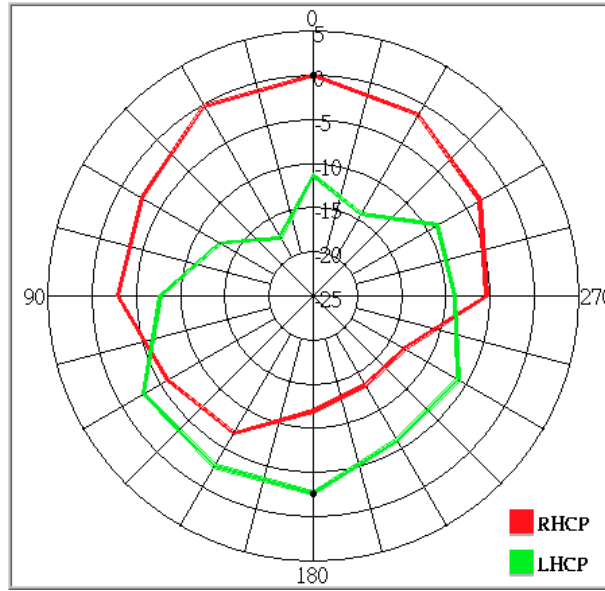

Circular gain 2D x-z plane pattern

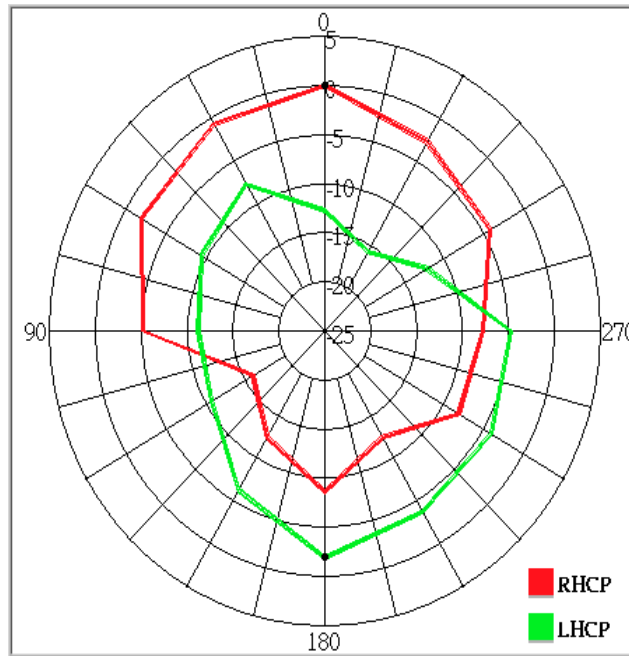

Circular gain 2D y-z plane pattern

GPS active antenna (13*13*7 mm)				CAN 431343486158 1B				—	1	March, 07	
								▶	2	June, 08	
								—	3		
BY / 製定者	Sunwiun Hu	SUPER / 原圖編號	C.T.Lee	TLL. SH/ 共頁	12	PAGE/ 頁	7	SH nr.	—	4	
CHECK				DATE / 日期	June.,2008		—	5			

The Characteristics of LNA

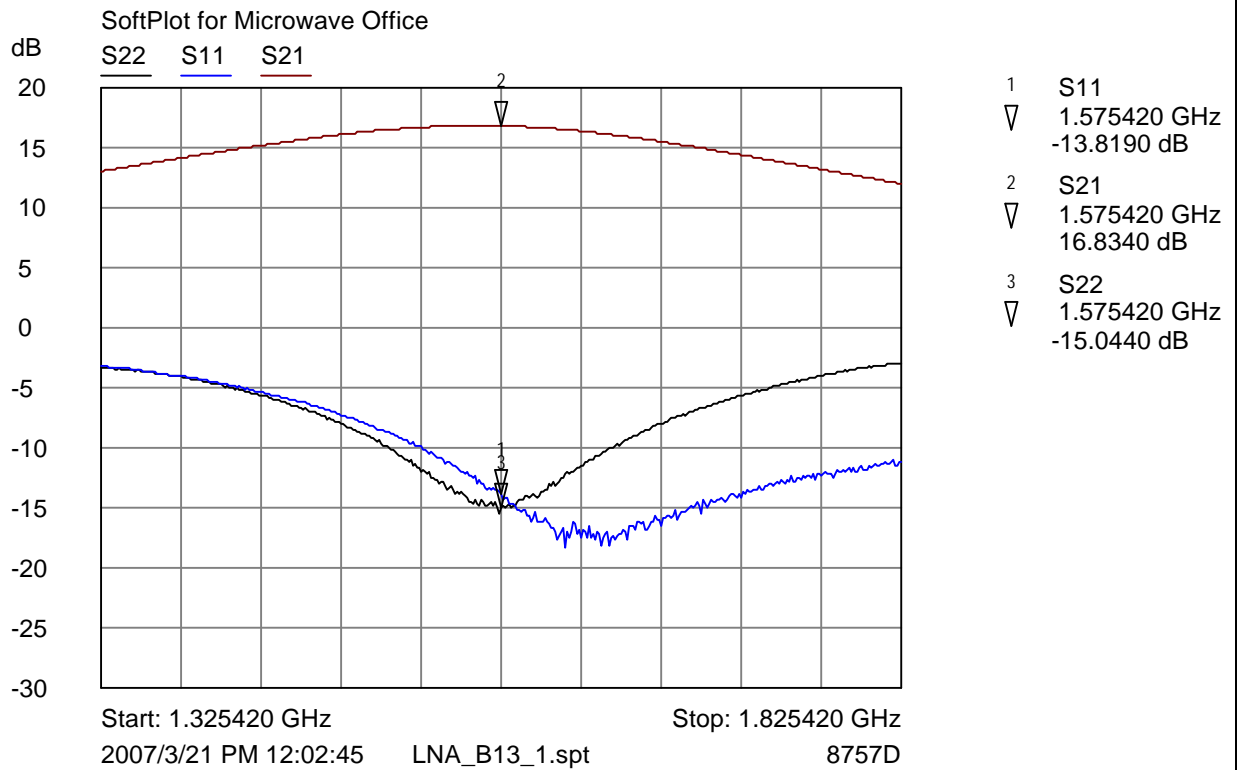

NF=1.3 dB

GPS active antenna (13*13*7 mm)				CAN 431343486158 1B				1	March, 07
								2	June, 08
								3	
BY / 製定者	Sunwiun Hu	SUPER / 原圖編號	C.T.Lee	TLL. SH/ 共頁	12	PAGE/ 頁	8	SH nr.	4
CHECK				DATE / 日期	June.,2008			5	

Outlines and Dimension

Dimension

Length	13.0 +/- 0.5 mm
Width	13.0 +/- 0.5 mm
Thickness	7.5 +/- 0.5 mm
Cable	Diameter D = 1.13 mm; Length L = 100 mm
Connector	I-pex
Shielding Case	12*10*2 mm

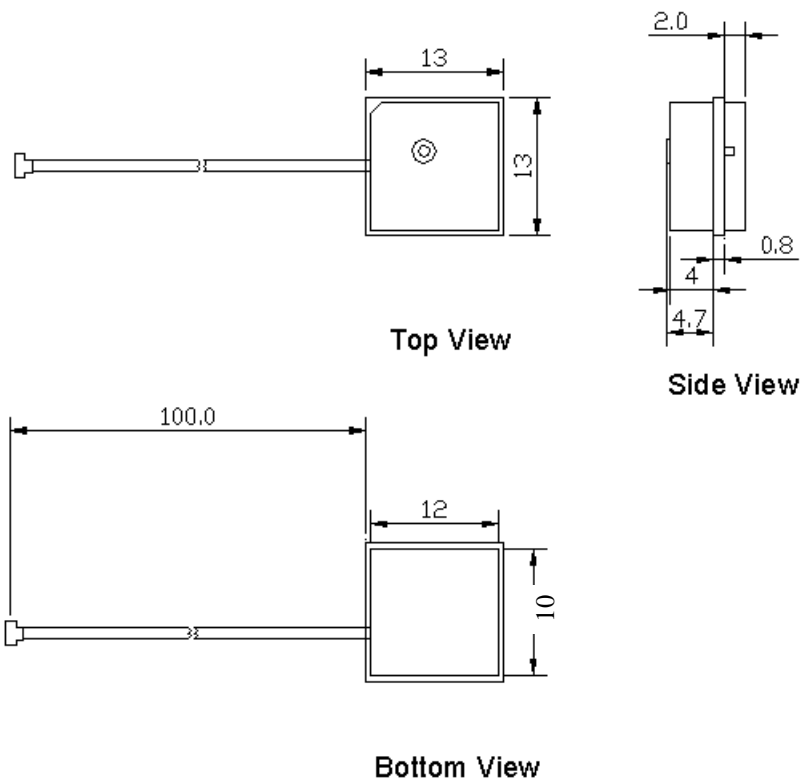

GPS active antenna (13*13*7 mm)				CAN 431343486158 1B				—	1	March, 07	
								▶	2	June, 08	
								—	3		
BY / 製定者	Sunwiun Hu	SUPER / 原圖編號	C.T.Lee	TLL. SH/ 共頁	12	PAGE/ 頁	9	SH nr.	—	4	
CHECK				DATE / 日期	June.,2008			—	5		

ORDERING INFORMATION:

The active antennas may be ordered by using the Yageo ordering code. These code numbers can be determined by the following rules:

CAN43 13 4 34 86 158 1B
F C M S T A P

F. Family Code

CAN 43 = Antenna

C. Packing Type Code

13 = bulk packaging

M. Materials Code

4 = Microwave Ceramic Material

S. Size code

34 = 13*13 mm

T. Type

86 = GPS active antenna, type 86 (1 stage LNA)

A. Working Frequency

158 = 1.575 GHz, GPS application

P. Packing Type Code

1B = bulk packaging

GPS active antenna (13*13*7 mm)				CAN 431343486158 1B				—	1	March, 07	
								▶	2	June, 08	
								—	3		
BY / 製定者	Sunwiun Hu	SUPER / 原圖編號	C.T.Lee	TLL. SH/ 共頁	12	PAGE/ 頁	10	SH nr.	—	4	
CHECK				DATE / 日期	June.,2008			—	5		

Packing information

1. Each unit into individual compartment. Two layers of compartment.
2. 100 units per compartment layer. 200 units into one carton.
3. Carton dimension: 493*257*167 mm
4. Cover upper and lower sides of the box with a cardboard.

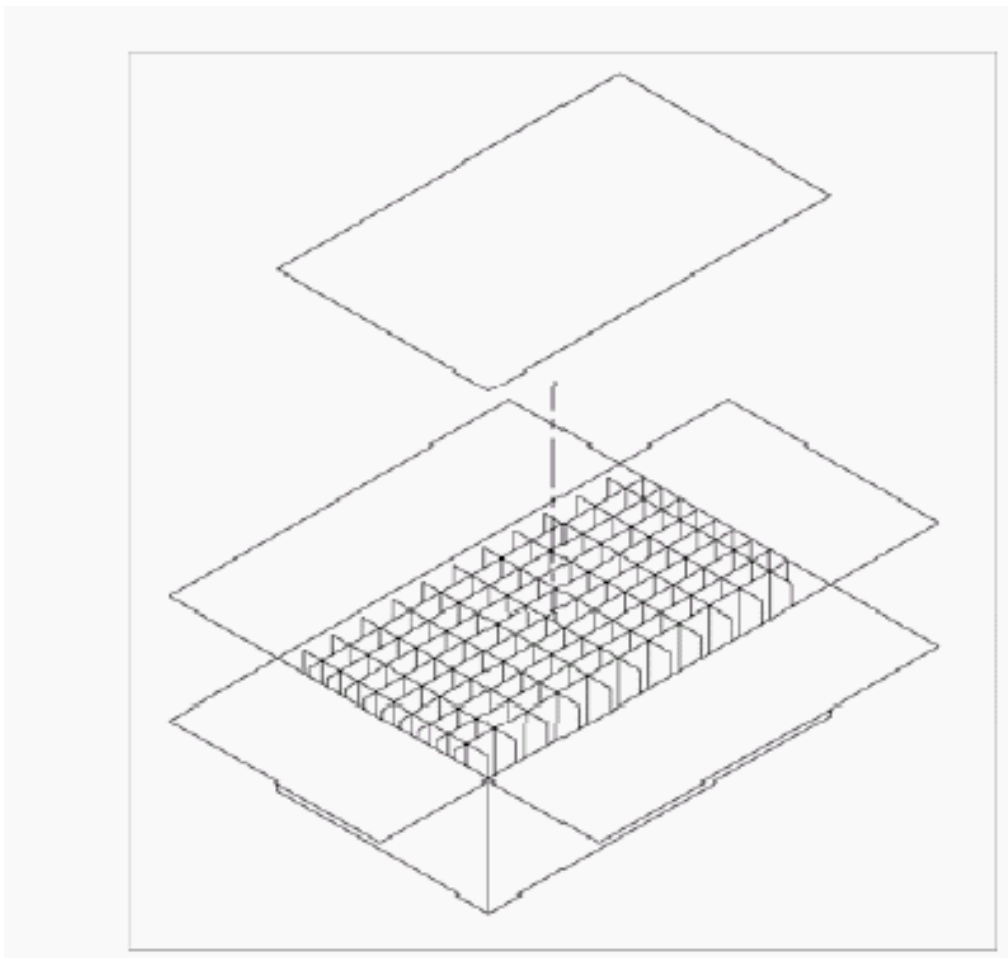

GPS active antenna (13*13*7 mm)				CAN 431343486158 1B				—	1	March, 07	
								▶	2	June, 08	
								—	3		
BY / 製定者	Sunwiun Hu	SUPER / 原圖編號	C.T.Lee	TLL. SH/ 共頁	12	PAGE/ 頁	11	SH nr.	—	4	
CHECK				DATE / 日期	June.,2008			—	5		

Revision Control:

Revision	Date	Content	Remark
1	March, 2007	New Issued	
2	June, 2008	Modify shielding case dimension	

GPS active antenna (13*13*7 mm)				CAN 431343486158 1B				—	1	March, 07	
								▶	2	June, 08	
								—	3		
BY / 製定者	Sunwiun Hu	SUPER / 原圖編號	C.T.Lee	TLL. SH/ 共頁	12	PAGE/ 頁	12	SH nr.	—	4	
CHECK				DATE / 日期	June.,2008			—	5		