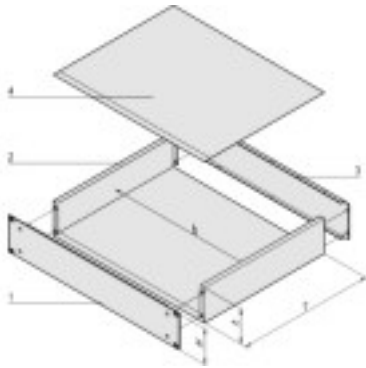
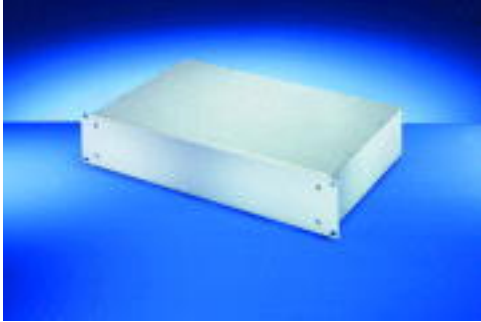

19" chassis, steel sheet (Al/Zn)
[Print page](#)

h = clear overall height (H - 3.0),
b = clear installation width = 447 mm

Article number: 20860-127

- Complete chassis, St (AlZn coated) with Al extrusion front panel
- Detachable rear panel for easy assembly
- 19" and ATX power supplies can be assembled in the 1 U version up to a clearance of 40 mm

Delivery comprises: kit

Item	Qty	Description
1	1	Front panel, Al extrusion, 2 mm, front anodised, rear etched (at 1 U), front and rear side of front panels colourless chromated (at 2 U)
2	1	Base body plain, St, 1 mm, (AlZn coated)
3	1	Rear panel, St, 1 mm (AlZn coated)
4	1	Cover plain, St, 1 mm (AlZn coated)
5	1	Assembly kit

Technical data:

Height H	H	Depth	Depth T
2 U	88.1 mm	340 mm	340 mm



Accessories:

Article number	Description
20860-257	Front handles

Notes:

- Further versions with steel sheet front panel (pizza box) on request
- Use of telescopic slides is not possible
- No special EMC version available
- Interior mounting kits not suitable for IEC 60297

Further Information:

	3D PDF with CAD data (STEP/PDF)
	User Manual
	<p>Customized application / Networking</p> <p>Customized application / 19" mounting</p> <p>Customized application / EMC case</p> <p>Customized application / 19" angle removable</p> <p>Customized application / 2U case with IEEE boards</p> <p>Customized application / 19" angles</p> <p>Customized application / LAN switch with RJ45 plugs</p> <p>Customized application</p> <p>Customized application</p> <p>Customised application</p>