

Optocoupler – Overview

Owing to the increasing degree of automation, the separation of potential between control circuits (control side / field side) is becoming increasingly significant. The connection between the controller, which is the key component of every automated system, and the various sensors and actuators must be electrically safe and free of any feedback. Optocouplers are finding increasing use here. They provide the necessary degree of safety and feature other technical properties such as:

- Low power consumption on the controller side
- High switching frequency
- No contact bounce
- Wear-free switching
- Vibration resistance
- Use independent of positioning
- No need for mechanical parts
- Long service life
- High insulation voltage

Accordingly, optocouplers are a good alternative to the traditional, mechanical relay interfaces. Modules with different input voltages and enclosure technologies are available for industrial use.

CE marking

Weidmüller's optocouplers carry the CE mark and comply with the requirements laid down by EN 50 081 part 1 and EN 50 082 part 2. They can be used in a wide range of applications and industries.

Suitable ESD measures must be taken during installation. Overvoltage protection must be provided for long leads as protection from lightning.

Optocoupler – Overview

Our highlight
MICROSERIES

Coupler modules in terminal format

The slot-in width of 6.1 mm allows space-saving installation of the **MICROSERIES** relays in industrial automation applications. The **MICROSERIES** is particularly suitable for the modification and extension of equipment and machinery, where it helps to make optimum use of the limited space available in switchgear cabinets.

Marking

The tab surfaces enable equipment to be clearly marked using a WS marker.



Holding and ejecting mechanism

The innovative holding and ejecting mechanism clips the assembled module securely onto the base terminal. Using the reliable eject function, the coupler can be removed quickly and simply from the base.

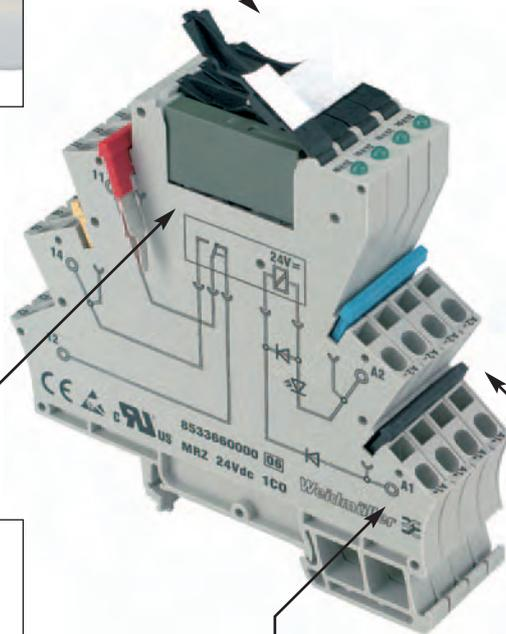

Relay and optocoupler module

Plug-in relay and optocoupler modules allow individual adjustment to function of the base module. Relay and optocouplers, are available with different power outputs, with either AgSnO and gold contacts.



Connection technology

Most of our relay couplers are available with screw or tension clamp connections.



Pluggable cross-connectors

The ZQV 4N plug-in cross-connectors are available in various colours and with different numbers of poles. They allow reliable and distinct cross-connections between the four input and output potentials.



Optocoupler – Overview

Control side of the optocoupler interface

Basic structure of the optocoupler interface:

The key component is the actual optoelectronic unit (optocoupler) which is responsible for the coupling.

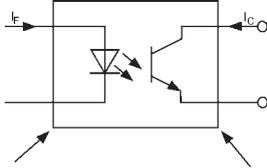

One important variable of this component is the current transfer rate (CTR). The CTR factor is stated as a percentage and describes the relationship between dispensed input current I_F and the maximum available output current I_C .

Example: $I_F = 10 \text{ mA}$; $CTR = 100 \%$ $\Rightarrow I_C = 10 \text{ mA}$.

However, the CTR variable is influenced by various parameters such as ambient temperature, degree of efficiency of the luminescence diode or geometric dimensions within the component, and itself declines over time. This means that the switching thresholds change over time, partly as a result of ageing.

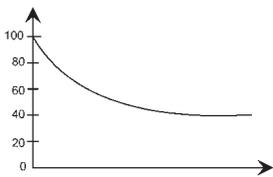

In order to eliminate this effect as far as possible, Weidmüller optocouplers use almost exclusively optoelectronic semiconductors with high long-term stability in terms of CTR behaviour.

The insulation strength of the component is also important, because the actual coupling of the input and output circuits results from optical transfer. This means that even in the event of a fault, the optical component will guarantee separation of both circuits. By using optoelectronic coupling elements in accordance with DIN VDE 0884, Weidmüller's optocouplers represent the ultimate in safety.

The circuitry within the module as a whole also deserves to be mentioned, with features including "protective separation" in accordance with DIN VDE 0106 part 101.

Optocouplers for galvanic isolation or "protective separation"

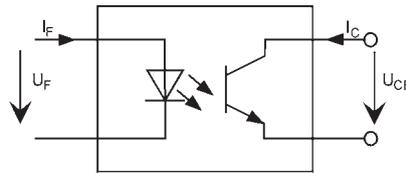

The partial discharge level test as per DIN VDE 0884 is the primary prerequisite for "protective separation" with optoelectronic coupler modules. Double or reinforced insulation for "protective separation" must be partially discharge-proof. High-voltage testing, a standard procedure for relays, is not possible with semiconductors because it may actually destroy them. In the case of coupler modules with integrated optocouplers, "protective separation" for the specified rated voltage is achieved when the following requirements are satisfied:

- Testing of the optocouplers as per DIN VDE 0884
- Adherence to creepage and clearance path on circuit boards and connection elements in accordance with EN 50 178, DIN VDE 0106 and 0109.

A distinction is made between three basic circuits on the input side of the optocoupler interfaces:

- Pure DC input

Here there is a reversed polarity protection diode which prevents damage to the module in the case of reversed input polarity

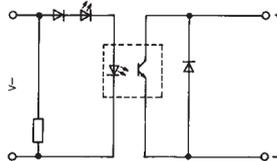

- AC/DC input

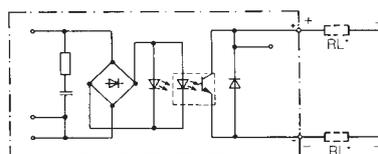

Here it is not possible to reverse the polarity of the DC input signal. The disadvantage of the AC/DC input circuit

(with DC signal trigger) is the lower switching frequency of the module, because the charge capacitor (C_L , necessary for AC input signals) reduces the maximum switching frequency

- AC input

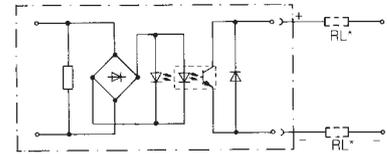

Here again, the charging capacity has a major influence on the maximum switching frequency of the module as a whole. Weidmüller optocouplers with AC/DC or AC input signals are rated for mains frequencies of approx. 40 – 60 Hz. In the case of AC input signals, the maximum switching frequency of the optocoupler module is less than half the mains frequency. A higher switching frequency is not possible, because this would result in constant switching in the rhythm of the mains frequency.

Load side of the optocoupler interface

Weidmüller optocoupler modules have been dimensioned and developed for use in a wide range of applications and industries.

Possible demands made on the load side of the optocoupler modules include:

- power amplification
- AC/DC and DC/AC signal conditioning
- short-circuit protection
- interference immunity

To meet these requirements, the modules are assembled with additional electronic elements which then define the overall functioning of the optocoupler module.

Accordingly, there are always two versions for the load side of the optocoupler: output as a 2-pole or 3-pole circuit.

Optocoupler – Overview

Optocoupler

2-pole DC output

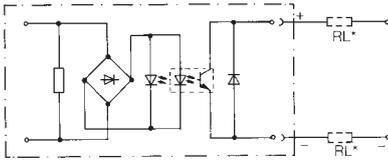

The 2-pole DC output can be compared with a conventional switch. In this version it does not matter where the load is located (in the output circuit), although the necessary output supply voltage must be available with the right polarity.

Optocoupler modules are usually indicated with an output supply voltage range of, for example, 5 ... 48 Vdc. The voltage should on no account ever be lower or higher than these values. The load current should not be higher than the stated maximum output current. If current constantly exceeds this value, the output stage will be destroyed.

Derating diagrams show the relationship of output current to ambient temperature (indicated for the products on the following pages).

2-pole AC output

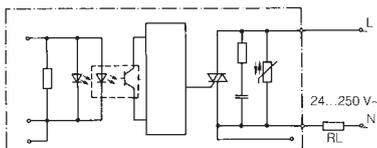

A special semiconductor module (TRIAC) is used for switching AC voltage in the output stage of the optocoupler. Here, as with the DC output, consideration must also be given to the key data such as voltage, frequency, maximum load current and ambient temperature.

Use of the zero voltage switch ensures that the load is only switched on at the zero crossover of the voltage. The modules are always equipped with suitable protection elements (varistor, RC combination) as protection from non-permissible voltage peaks.

3-pole DC output

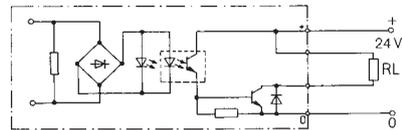

In order to function reliably, this kind of output level required potential-related output supply voltage with a single output. It is rated for either positive switching (joint reference potential: GND or 0V) or negative switching (joint reference potential: positive voltage pole).

Standards

The following standards are complied with:

- EN 50 178:
Electronic equipment for use in high current installations
- DIN VDE 01206 part 101:
Protection from dangerous body currents, basic requirements for "protective separation" in electrical equipment
- DIN VDE 0884:
Optoelectronic couplers for "protective separation"
- DIN VDE 0109:
Insulation coordination for equipment within low-voltage systems, including creepage and clearance distances for configured printed circuit boards

Protection circuits

All optocoupler modules have a protection circuit in the output (usually with a freewheel diode).

The load side must be protected to prevent interference signals from coupling into other lines.

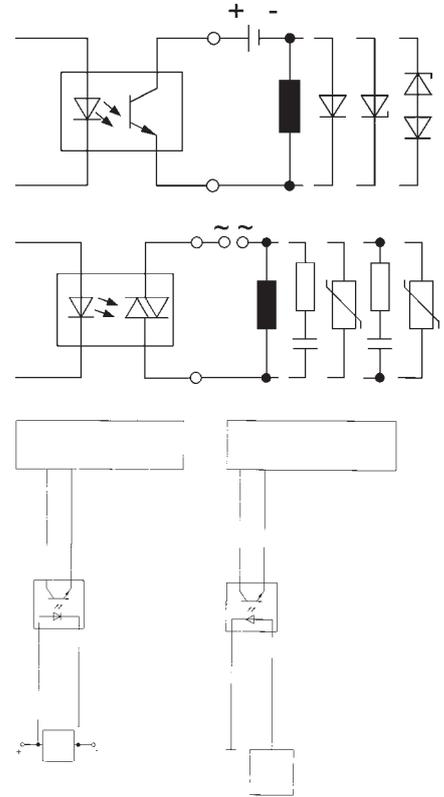

Optocoupler – Overview

Enclosure types for relay couplers

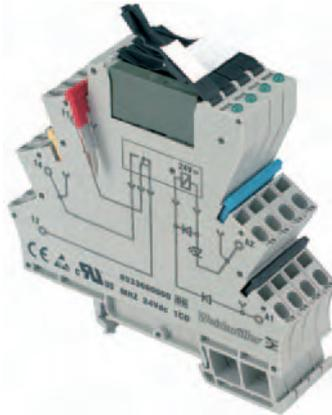
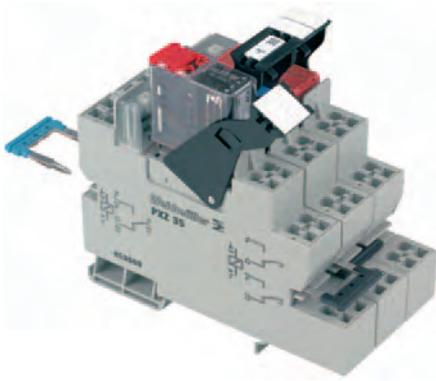

PLUGSERIES

The modular component system represents a new generation of plug-in optocouplers. The key element is a PXS (screw clamp) or PXZ (tension clamp) innovative relay base. Both products reflect the functionality of relays or optos and Weidmüller's experience in their commercial use. PLUGSERIES is the ideal connection system between the Solid State Relay (SSR) and the application.

Modular principle

The new PLUGSERIES is extremely easy to handle. Commercially available SSRs are simply plugged in, retaining clips provide a firm hold, and LED displays with a recovery diode can be plugged in.

- SSRs simply plugged in: suitable for standard and TD designs
- Independent connection technology: screw or tension clamp technology, nominal cross-sectional area 0.5 ... 2.5 mm²
- Robust design of the retaining/dismantling hook
- Control voltage 24 Vac/Vdc
- Rated switching voltage 24 Vdc, 24 Vac/Vdc, 230 Vac
- Up to 5 A continuous current
- Minimum wiring workload thanks to ZQV 2.5N plug-in cross-connectors
- Modular system allows easy handling:
 - Relay base, LED display, retaining hook and SSR
 - Clips on to the TS 35
 - Marking with WS tabs on retaining hook
- Plug-in LED with recovery diode.

MICROSERIES

Relay and optocoupler versions in the MICROSERIES are used in industrial automation applications for separating and coupling digital input and output signals. The space saving design makes them perfectly suited for use in sub-distributors or switchgear cabinets. With its compact shape, MICROSERIES combines the functions of the classical coupling level with the terminal level.

- Slot-in width 6.1 mm
- Pluggable cross-connection for four input and output potentials
- Tried and tested ZQV 4N cross-connector system
- Wide range of input voltage from 5 .. 230 V
- LED power light, reverse polarity protection diode, freewheel diode
- WEMID enclosure material (flammability V0 as per UL 94)
- Innovative holding and eject mechanism
- Marking surface to take standard WS 12/6 marking

CE marking

Weidmüller's relay couplers carry the CE mark and comply with the requirements laid down by EN 50 081 part 1 and EN 50 082 part 2. They can be used in both industrial-scale and smaller-scale applications.

Suitable ESD measures must be taken during installation. Overvoltage protection must be provided for long leads as protection from lightning.

WAVESERIES

Innovative electronic components require a housing or enclosure which reflects their specific functions. It must allow adjusting and control functions and support technical requirements, such as heat dissipation or electromagnetic compatibility. A compact design saves space in the switchgear cabinet and reduces assembly costs. Ergonomic design is increasingly important for top-quality relay coupler interfaces.

The WAVESERIES fulfils all these criteria, with outstanding features including:

- Assembly without tools
- Printed circuit board
- Pluggable PCB
- ZQV 2.5V pluggable cross-connection
- Hinged transparent cover
- Marking with WS tabs
- Clips onto TS 35

Connection systems

The user can choose between BLZ screw plug-in connectors and BLZF tension clamp plug-in systems, up to 2.5 mm² and finely stranded, for the greatest possible flexibility when wiring up the circuits.

Printed circuit board

If the lateral locking hook is squeezed on the head end, it can be pulled out of the enclosure together with the connection level and the circuit board. The circuit board can only be pulled out without current voltage.

Cross-connection

The ZQV 2.5 N/2 cross-connectors can be used to connect rows of Waveseries enclosures. The cross-connection can take up to 8 A of current. It can be used for bridging the supply voltage from one electronic module to another. The voltage at the cross-connection must not exceed 50 V.

Ventilation slits

Diagonal ventilation slits ventilate the lower parts of the enclosures and keep temperatures moderate.

Optocoupler – Overview

Enclosure types for relay couplers

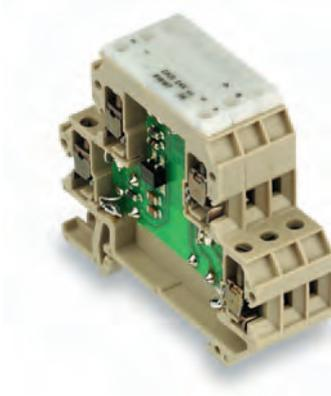

DK SERIES

All components in the DKO mini-coupler are of an extremely slim design: use of advanced surface-mounted parts (SMD) allows the width to be kept to just 6 mm. The range includes 4 or 5 screw connections for conductor cross-section of 0.5 ... 4 mm². The mini couplers offer a wide range of applications for coupling digital sensor/actuators or signals with automation devices and the process field. DKO optocouplers can be used to pick up and standardise signals from the field with different voltages.

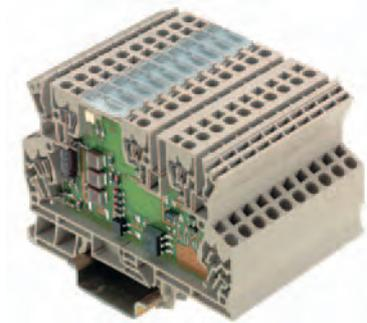

MCZ SERIES

The MCZ enclosure is only 6 mm wide and one of the narrowest of its kind. Its outstanding technical features include:

- Tension clamp connection to reduce assembly costs
- Integrated input/output cross-connection to reduce wiring workload

MCZO mini-conditioners (optocouplers) have 4 or 5 tension spring connections.

The cross-section of the clamping conductor is 0.5 ... 1.5 mm².



EG SERIES

The EG7 integral housing has a special status because it is suited only for the installation of 10 mm compact optocouplers. EG7 optocouplers can be mounted on either the TS 32 or TS 35. An RS EG7 snap-in base is also available for the OST plug-in optocouplers.

The closed EG 7 enclosures are equipped with tension clamp unit for screw connection.

Conductors with the following cross-sections can be connected:

- Integral housing EG 7: 0.5 ... 1.5 mm²
- OST clip-in base: 0.5 ... 2.5 mm²

PLUGSERIES

Output current 24 Vdc / 2.5A

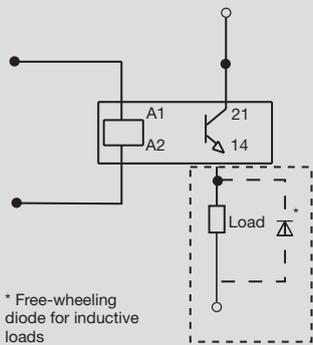
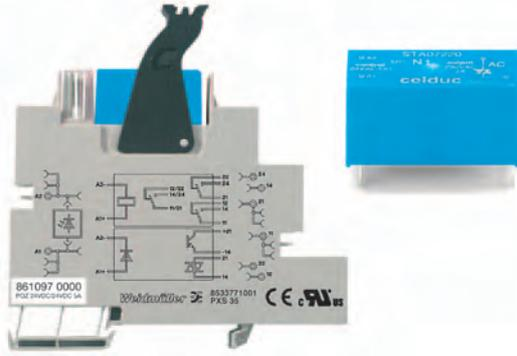

Output			
Output voltage	0 V ... 30 Vdc		
Output current (max.)	2.5 A		
Voltage drop at max. load	< 0.4 V		
Block-state curr. (closed circuit curr.)	< 1 mA		
Switch-on delay/Switch-off delay	2ms/18ms		
Short-circuit proof/Protective circuit	No/integrated freewheel diode		
General data			
Ambient temp., fitted w/o distance	-40 °C...+50 °C		
Ambient temp., fitted w. distance	-40 °C...+50 °C		
Storage temperature	-40 °C...+50 °C		
Approvals	cUL, UL recognized		
Insulation coordinates (EN 50 178)			
Standards	EN 50178		
Rated voltage	300V		
Rated impulse voltage	2.5kV		
Creepage and clearance path input - output	8mm		
Overvoltage category	III		
Pollution severity	2		
Dimensions		Screw connection	Tension clamp connection
Clamping range (rating- / min. / max.)	mm ²	2.5 / 0.5 / 2.5	2.5 / 0.5 / 2.5
Length x width x height	mm	92.0 / 15.3 / 95.0	92.0 / 15.3 / 87.0
Information			

Ordering data

Input

Rated voltage
Rated current
Power rating
Auxiliary voltage
Status indicator

24VDC/24VDC 2.5A

15 Vdc...30 Vdc
approx. 10mA
250 mW
No
LED green

K

Ordering data

Complete module

Screw connection Type
Order No.
Tension clamp connection Type
Order No.

POS 24VDC/24VDC 2A

8610840000

POZ 24VDC/24VDC 2A

8610920000

Ordering data

Spare relay, pluggable

Type
Order No.

SSR 24V ACDC/24 VDC 2A

8576340000

Information

PLUGSERIES

Output current 24 Vdc / 5A

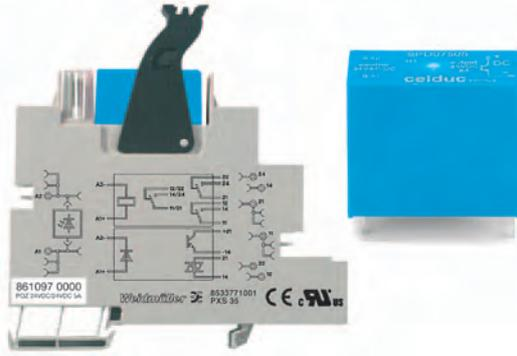

Optocoupler

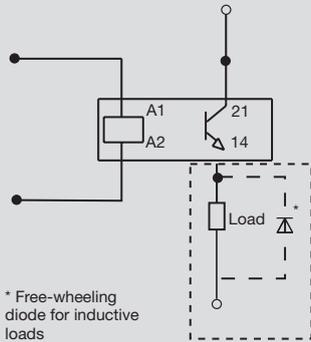

Output			
Output voltage	0 V ... 30 Vdc		
Output current (max.)	5 A		
Voltage drop at max. load	< 0.3 V		
Block-state curr. (closed circuit curr.)	< 1 mA		
Switch-on delay/Switch-off delay	2ms/18ms		
Short-circuit proof/Protective circuit	No/integrated freewheel diode		
General data			
Ambient temp., fitted w/o distance	-40 °C...+50 °C		
Ambient temp., fitted w. distance	-40 °C...+50 °C		
Storage temperature	-40 °C...+50 °C		
Approvals	cUL, UL recognized		
Insulation coordinates (EN 50 178)			
Standards	EN 50178		
Rated voltage	300V		
Rated impulse voltage	2.5kV		
Creepage and clearance path input - output	8mm		
Overvoltage category	III		
Pollution severity	2		
Dimensions		Screw connection	Tension clamp connection
Clamping range (rating- / min. / max.)	mm ²	2.5 / 0.5 / 2.5	2.5 / 0.5 / 2.5
Length x width x height	mm	92.0 / 15.3 / 95.0	92.0 / 15.3 / 87.0
Information			

Ordering data

Input

Rated voltage
Rated current
Power rating
Auxiliary voltage
Status indicator

24VDC/24VDC 5A

15 Vdc...30 Vdc
approx. 10mA
250 mW
No
LED green

Ordering data

Complete module

Screw connection Type
Order No.
Tension clamp connection Type
Order No.

POS 24VDC/24VDC 5A
861090000
POZ 24VDC/24VDC 5A
861097000

Ordering data

Spare relay, pluggable

Type
Order No.

SSR 24V ACDC/24 VDC 5A
857635000

Information

K

PLUGSERIES

Output current 24 Vdc / 1A

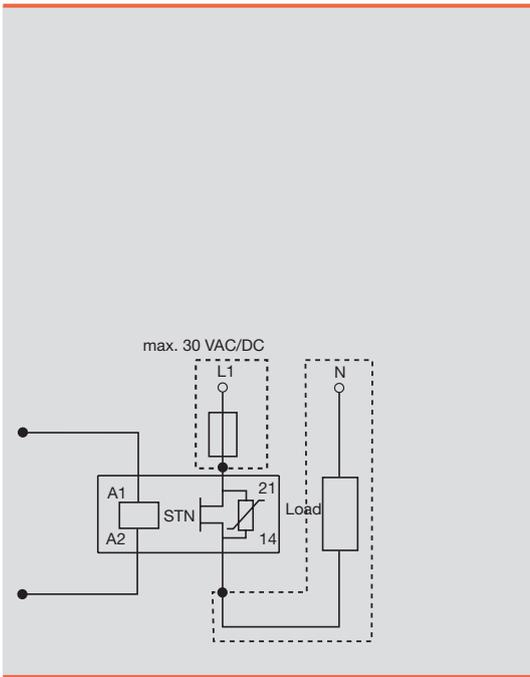
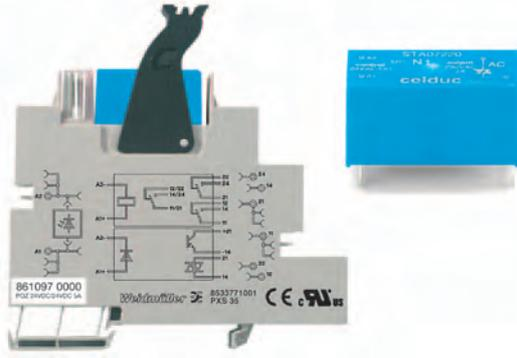

Output			
Output voltage	0 V ... 30 Vdc		
Output current (max.)	1 A		
Voltage drop at max. load	< 0.9 V		
Block-state curr. (closed circuit curr.)	< 1 mA		
Switch-on delay/Switch-off delay	5ms/12ms		
Short-circuit proof/Protective circuit	No/integrated freewheel diode		
General data			
Ambient temp., fitted w/o distance	-40 °C...+50 °C		
Ambient temp., fitted w. distance	-40 °C...+50 °C		
Storage temperature	-40 °C...+50 °C		
Approvals	cUL, UL recognized		
Insulation coordinates (EN 50 178)			
Standards	EN 50178		
Rated voltage	300V		
Rated impulse voltage	4.0kV		
Creepage and clearance path input - output	8mm		
Overvoltage category	III		
Pollution severity	2		
Dimensions		Screw connection	Tension clamp connection
Clamping range (rating- / min. / max.)	mm ²	2.5 / 0.5 / 2.5	2.5 / 0.5 / 2.5
Length x width x height	mm	92.0 / 15.3 / 95.0	92.0 / 15.3 / 87.0
Information			

Ordering data

Input		24VDC/24VUC 1A
Rated voltage		15 Vdc...30 Vdc
Rated current		approx. 10mA
Power rating		250 mW
Auxiliary voltage		No
Status indicator		LED green

Ordering data Complete module

Screw connection	Type	POS 24VDC/24VUC 1A
	Order No.	8610890000
Tension clamp connection	Type	POZ 24VDC/24VUC 1A
	Order No.	8610960000

Ordering data Spare relay, pluggable

	Type	SSR 24V ACDC/24VACDC
	Order No.	8576380000

Information



PLUGSERIES

Output current 230 Vac / 2A

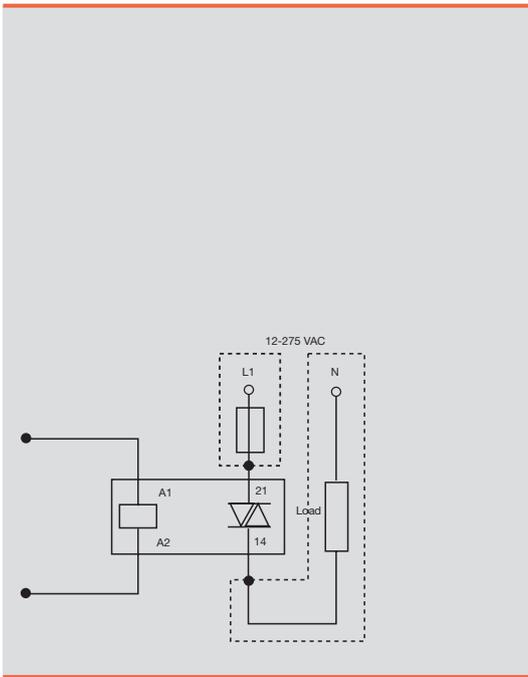
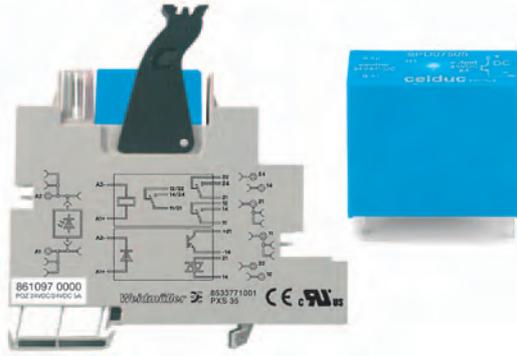

Output			
Output voltage	12 V ... 275 Vac		
Output current (max.)	2 A		
Voltage drop at max. load	< 1 V		
Block-state curr. (closed circuit curr.)	< 1 mA		
Switch-on delay/Switch-off delay	12ms/20ms		
Short-circuit proof/Protective circuit	No/RC-element		
General data			
Ambient temp., fitted w/o distance	-40 °C...+50 °C		
Ambient temp., fitted w. distance	-40 °C...+50 °C		
Storage temperature	-40 °C...+50 °C		
Approvals	cUL, UL recognized		
Insulation coordinates (EN 50 178)			
Standards	EN 50178		
Rated voltage	300V		
Rated impulse voltage	4.0kV		
Creepage and clearance path input - output	8mm		
Overvoltage category	III		
Pollution severity	2		
Dimensions		Screw connection	Tension clamp connection
Clamping range (rating- / min. / max.)	mm ²	2.5 / 0.5 / 2.5	2.5 / 0.5 / 2.5
Length x width x height	mm	92.0 / 15.3 / 95.0	92.0 / 15.3 / 87.0
Information			

Ordering data

Input		24VDC/230VAC 2A
Rated voltage		15 Vdc...30 Vdc
Rated current		approx. 10mA
Power rating		250 mW
Auxiliary voltage		No
Status indicator		LED green

Ordering data

Complete module				
Screw connection	Type	POS 24VDC/230VAC 2A		
	Order No.	8610860000		
Tension clamp connection	Type	POZ 24VDC/230VAC 2A		
	Order No.	8610930000		

Ordering data

Spare relay, pluggable				
	Type	SSR 24V ACDC/230VAC 2A		
	Order No.	8576370000		

Information

--	--	--	--	--

PLUGSERIES

Output current 230 Vac / 4A

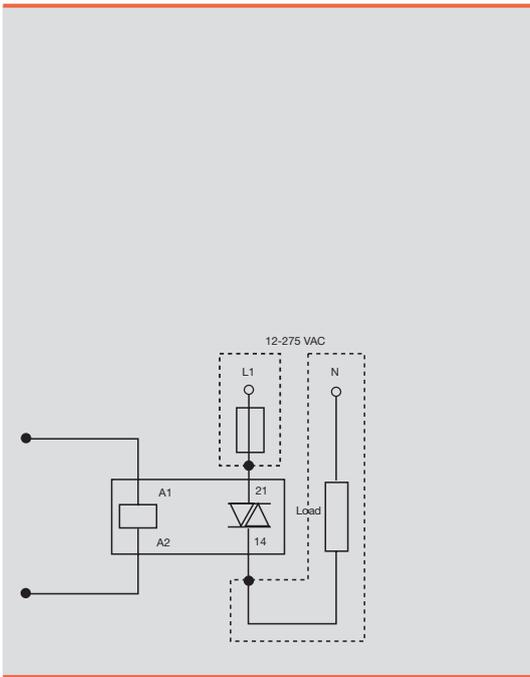
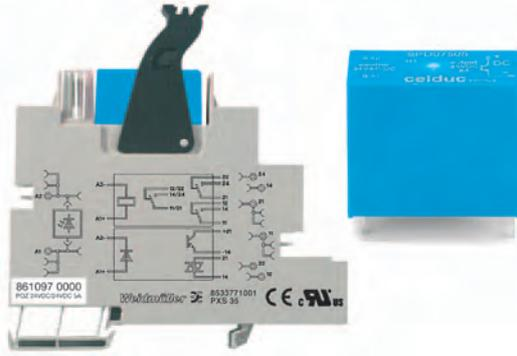

Output			
Output voltage	12 V ... 275 Vac		
Output current (max.)	3 A (4 A at 20°C)		
Voltage drop at max. load	< 1.1 V		
Block-state curr. (closed circuit curr.)	< 1 mA		
Switch-on delay/Switch-off delay	12ms/20ms		
Short-circuit proof/Protective circuit	No/RC-element		
General data			
Ambient temp., fitted w/o distance	-40 °C...+50 °C		
Ambient temp., fitted w. distance	-40 °C...+50 °C		
Storage temperature	-40 °C...+50 °C		
Approvals	cUL, UL recognized		
Insulation coordinates (EN 50 178)			
Standards	EN 50178		
Rated voltage	300V		
Rated impulse voltage	4.0kV		
Creepage and clearance path input - output	8mm		
Overtoltage category	III		
Pollution severity	2		
Dimensions		Screw connection	Tension clamp connection
Clamping range (rating- / min. / max.)	mm ²	2.5 / 0.5 / 2.5	2.5 / 0.5 / 2.5
Length x width x height	mm	92.0 / 15.3 / 95.0	92.0 / 15.3 / 87.0
Information			

K

Ordering data

Input		24VDC/230VAC 4A
Rated voltage		15 Vdc...30 Vdc
Rated current		approx. 10mA
Power rating		250 mW
Auxiliary voltage		No
Status indicator		LED green

Ordering data

Complete module				
Screw connection	Type	POS 24VDC/230VAC 4A		
	Order No.	8610910000		
Tension clamp connection	Type	POZ 24VDC/230VAC 4A		
	Order No.	8610980000		

Ordering data

Spare relay, pluggable				
	Type	SSR 24V ACDC/230VAC 4A		
	Order No.	8576360000		

Information

--	--	--	--	--

PLUGSERIES

Accessories

Schrack RP3SL

Relay for high switch-on current

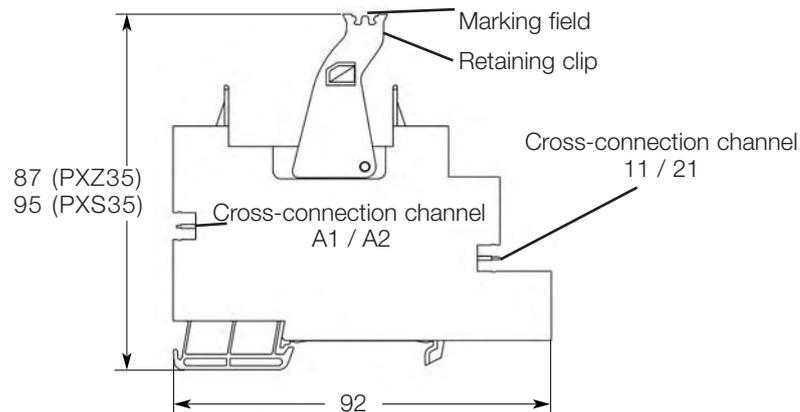

Technical data

Empty base	
Rated current	16 A
Rated voltage	250 V
Voltage strength coil / contacts	> 4 kV
Protection	IP 20
Rated cross-sectional area	2.5 mm ²
Stripping length	8 mm
	10 mm
Ambient temperature	-40°C ... +60°C
Flammability class as per UL 94	V-0

screw connection
tension clamp

Tension clamp connection

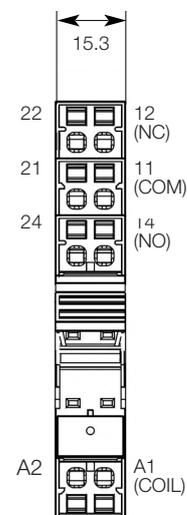

Screw connection

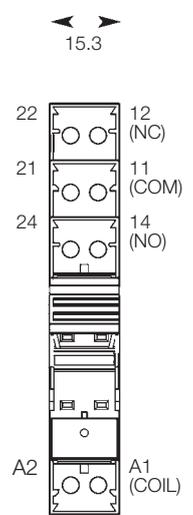

Order data

Empty base for assembly on the TS 35 mounting rail			
Screw connection	PXS35	10	8533771001
Tension clamp	PXZ35	10	8536691001

Retaining clip			
	PRC	100	8536700000

LED display with freewheeling diode			
6 ... 24 Vdc	PLED 24 Vdc	20	8536710000
LED red, 6 ... 24 Vdc	PLED 24 Vdc rot	20	8611010000
48 ... 60 Vdc	PLED 48 Vdc	20	8536720000
115 Vdc	PLED 115 Vdc	20	8536730000
12 ... 24 Vac	PLED 24 Vac	20	8536750000
115 Vac	PLED 120 Vac	20	8536760000
230 Vac	PLED 230 Vac	20	8536780000
LED red, 230 Vac	PLED 230 Vac rot	20	8611000000
RC combination 120...230 VAC/DC	PLRC 200 nF/200Ω	20	8566530000

Pluggable cross-connections				
2-pole	black	ZQV 2.5N/4-2SW	60	1784270000
	red	ZQV 2.5N/4-2RT	60	1784280000
	blue	ZQV 2.5N/4-2BL	60	1784290000

Marking				
	10 x 5 mm	WS 10/5	200	1060860000
	15 x 5 mm	WS 15/5	96	1609880000

Operating control display

DC version

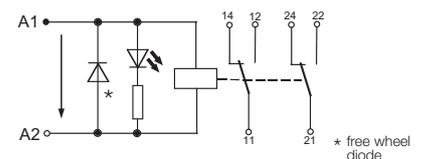

AC version

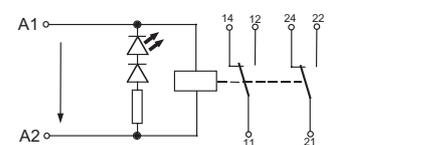

MICROSERIES

Output current 24 Vdc / 0.1A

Universal interface between control and sensor/actuator

- Pluggable cross-connection ZQV 4N
- Solid-state relay interchangeable
- Width 6.1 mm
- Screw or tension clamp connection technology
- Mounting on TS35

24VDC/24VDC 0.1A

120VUC/24VDC 0.1A

230VAC/24VDC 0.1A

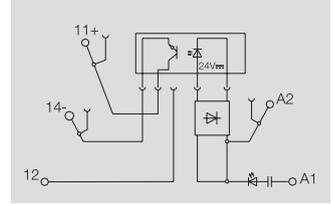
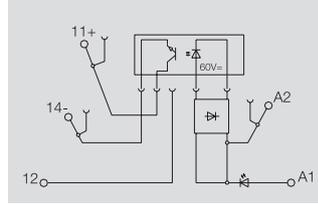
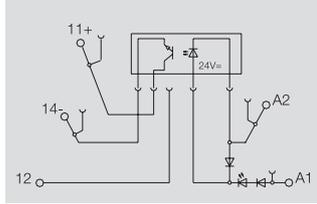

Technical data

Input

Rated voltage	24 Vdc +/- 20 %
Rated current	5.7mA
Power rating	140 mW
Max. input frequency	
Auxiliary voltage	No
Status indicator	LED green

Output

Output voltage	3 V... 48 Vdc
Output current (max.)	0.1 A
Voltage drop at max. load	< 1 V
Block-state curr. (closed circuit curr.)	< 1 mA
Switch-on delay/Switch-off delay	35µs/355µs
Short-circuit proof/Protective circuit	No/integrated freewheel diode

General data

Ambient temp., fitted w. distance	-25 °C...+50 °C
Ambient temp., fitted w/o distance	-25 °C...+50 °C
Storage temperature	-40 °C...+60 °C
Approvals	CE cRUus

Insulation coordinates (EN 50 178)

Standards	EN 50178
Rated voltage	300
Rated impulse voltage	4.0
Creepage and clearance path input - output	>= 5.5 mm
Overvoltage category	III
Pollution severity	2

Rated voltage	24 Vdc +/- 20 %
Rated current	5.7mA
Power rating	140 mW
Max. input frequency	
Auxiliary voltage	No
Status indicator	LED green

Output voltage	3 V... 48 Vdc
Output current (max.)	0.1 A
Voltage drop at max. load	< 1 V
Block-state curr. (closed circuit curr.)	< 1 mA
Switch-on delay/Switch-off delay	35µs/355µs
Short-circuit proof/Protective circuit	No/integrated freewheel diode

Ambient temp., fitted w. distance	-25 °C...+50 °C
Ambient temp., fitted w/o distance	-25 °C...+50 °C
Storage temperature	-40 °C...+60 °C
Approvals	CE cRUus

Standards	EN 50178
Rated voltage	300
Rated impulse voltage	4.0
Creepage and clearance path input - output	>= 5.5 mm
Overvoltage category	III
Pollution severity	2

Rated voltage	120 Vuc + 10 %/ -15 %
Rated current	3.4mA ac/2.8mA dc
Power rating	340 mW / 0.4 VA
Max. input frequency	dc: 10 Hz /ac: 3 Hz
Auxiliary voltage	No
Status indicator	LED green

Output voltage	3 V... 48 Vdc
Output current (max.)	0.1 A
Voltage drop at max. load	< 1 V
Block-state curr. (closed circuit curr.)	< 1 mA
Switch-on delay/Switch-off delay	< 6.5 ms/< 10 ms
Short-circuit proof/Protective circuit	No/integrated freewheel diode

Ambient temp., fitted w. distance	-25 °C...+50 °C
Ambient temp., fitted w/o distance	-25 °C...+50 °C
Storage temperature	-40 °C...+60 °C
Approvals	CE cRUus

Standards	EN 50178
Rated voltage	300
Rated impulse voltage	4.0
Creepage and clearance path input - output	>= 5.5 mm
Overvoltage category	III
Pollution severity	2

Rated voltage	230 Vac +/- 10 %
Rated current	7.4mA
Power rating	1.7 VA
Max. input frequency	3 Hz
Auxiliary voltage	No
Status indicator	LED green

Output voltage	3 V... 48 Vdc
Output current (max.)	0.1 A
Voltage drop at max. load	< 1 V
Block-state curr. (closed circuit curr.)	< 1 mA
Switch-on delay/Switch-off delay	< 6.5 ms/< 10 ms
Short-circuit proof/Protective circuit	No/integrated freewheel diode

Ambient temp., fitted w. distance	-25 °C...+50 °C
Ambient temp., fitted w/o distance	-25 °C...+50 °C
Storage temperature	-40 °C...+60 °C
Approvals	CE cRUus

Standards	EN 50178
Rated voltage	300
Rated impulse voltage	4.0
Creepage and clearance path input - output	>= 5.5 mm
Overvoltage category	III
Pollution severity	2

Dimensions

Clamping range (rating- / min. / max.)	mm ²
Length x width x height	mm

Information

CE, UL/UR	Mounting on TS35
-----------	------------------

Screw connection Tension clamp c.

2.50 / 0.50 / 4	2.50 / 0.50 / 4
93.0 x 6.1 x 92.0	93.0 x 92.0

CE, UL/UR	Mounting on TS35
-----------	------------------

Screw connection Tension clamp c.

2.50 / 0.50 / 4	1.50 / 0.50 / 2.50
93.0 x 6.1 x 92.0	93.0 x 6.1 x 92.0

CE, UL/UR	Mounting on TS35
-----------	------------------

Screw connection Tension clamp c.

2.50 / 0.50 / 4	1.50 / 0.50 / 2.50
93.0 x 6.1 x 92.0	93.0 x 6.1 x 92.0

CE, UL/UR	Mounting on TS35
-----------	------------------

Ordering data

Connection technology

Screw connection	
Tension clamp c.	

Type	(Qty.=10)	Order No.
MOS 24Vdc / 24Vdc 0.1A		8607340000
MOZ 5Vdc / 24Vdc 0.1A		8633010000

Information

Type	(Qty.=10)	Order No.
MOS 120Vuc / 24Vdc 0.1A		8607690000
MOZ 120Vuc / 24Vdc 0.1A		8607730000

Information

Type	(Qty.=10)	Order No.
MOS 230Vac / 24Vdc 0.1A		8607710000
MOZ 230Vac / 24Vdc 0.1A		8607750000

Information

Accessories

Information

Pluggable cross-connection ZQV 4N

Pluggable cross-connection ZQV 4N

Pluggable cross-connection ZQV 4N

Pluggable cross-connection ZQV 4N

MICROSERIES

Output current 24 Vdc / 2A

Universal interface between control and sensor/actuator

- Pluggable cross-connection ZQV 4N
- Solid-state relay interchangeable
- Width 6.1 mm
- Screw or tension clamp connection technology
- Mounting on TS35

24VDC/24VDC 2A

120VUC/24VDC 2A

230VAC/24VDC 2A

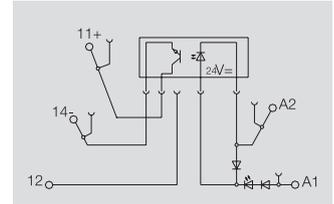
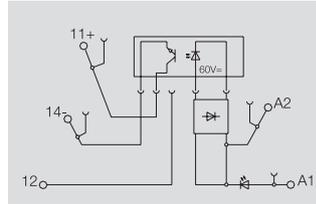
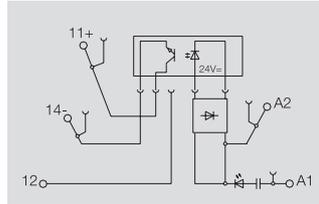

Technical data

Input

Rated voltage	24 Vdc +/- 20 %
Rated current	5.7mA
Power rating	140 mW
Max. input frequency	300 Hz
Auxiliary voltage	No
Status indicator	LED green

Output

Output voltage	3 V...33 Vdc
Output current (max.)	2 A
Voltage drop at max. load	< 120 mV
Block-state curr. (closed circuit curr.)	approx. 10 µA
Switch-on delay/Switch-off delay	< 55 us/< 1.2 ms
Short-circuit proof/Protective circuit	No/integrated freewheel diode

General data

Ambient temp., fitted w. distance	-25 °C...+50 °C
Ambient temp., fitted w/o distance	-25 °C...+50 °C
Storage temperature	-40 °C...+60 °C
Approvals	CE cRUus

Insulation coordinates (EN 50 178)

Standards	EN 50178
Rated voltage	300
Rated impulse voltage	4.0
Creepage and clearance path input - output	>= 5.5 mm
Overvoltage category	III
Pollution severity	2

120 Vuc + 10 %/ -15 %

Rated current	3.4mA ac/2.8mA dc
Power rating	340 mW / 0.4 VA
Max. input frequency	dc: 10 Hz /ac: 3 Hz
Auxiliary voltage	No
Status indicator	LED green

Output voltage	3 V...33 Vdc
Output current (max.)	2 A
Voltage drop at max. load	< 120 mV
Block-state curr. (closed circuit curr.)	approx. 10 µA
Switch-on delay/Switch-off delay	< 6.5 ms/< 10 ms
Short-circuit proof/Protective circuit	No/integrated freewheel diode

Ambient temp., fitted w. distance	-25 °C...+50 °C
Ambient temp., fitted w/o distance	-25 °C...+50 °C
Storage temperature	-40 °C...+60 °C
Approvals	CE cRUus

Standards	EN 50178
Rated voltage	300
Rated impulse voltage	4.0
Creepage and clearance path input - output	>= 5.5 mm
Overvoltage category	III
Pollution severity	2

230 Vac +/- 10 %

Rated current	7.4mA
Power rating	1.7 VA
Max. input frequency	3 Hz
Auxiliary voltage	No
Status indicator	LED green

Output voltage	3 V...33 Vdc
Output current (max.)	2 A
Voltage drop at max. load	< 120 mV
Block-state curr. (closed circuit curr.)	approx. 10 µA
Switch-on delay/Switch-off delay	< 6.5 ms/< 10 ms
Short-circuit proof/Protective circuit	No/integrated freewheel diode

Ambient temp., fitted w. distance	-25 °C...+50 °C
Ambient temp., fitted w/o distance	-25 °C...+50 °C
Storage temperature	-40 °C...+60 °C
Approvals	CE cRUus

Standards	EN 50178
Rated voltage	300
Rated impulse voltage	4.0
Creepage and clearance path input - output	>= 5.5 mm
Overvoltage category	III
Pollution severity	2

Dimensions

Clamping range (rating- / min. / max.)	mm ²
Length x width x height	mm

Information

CE, UL/UR
Mounting on TS35

Screw connection Tension clamp c.

Clamping range (rating- / min. / max.)	2.50 / 0.50 / 4	1.50 / 0.50 / 2.50
Length x width x height	93.0 x 6.1 x 92.0	93.0 x 6.1 x 92.0

CE, UL/UR
Mounting on TS35

Screw connection Tension clamp c.

Clamping range (rating- / min. / max.)	2.50 / 0.50 / 4	1.50 / 0.50 / 2.50
Length x width x height	93.0 x 6.1 x 92.0	93.0 x 6.1 x 92.0

CE, UL/UR
Mounting on TS35

Screw connection Tension clamp c.

Clamping range (rating- / min. / max.)	2.50 / 0.50 / 4	1.50 / 0.50 / 2.50
Length x width x height	93.0 x 6.1 x 92.0	93.0 x 6.1 x 92.0

CE, UL/UR
Mounting on TS35

Ordering data

Connection technology

Screw connection	Type	(Qty.=10)	Order No.
Tension clamp c.	MOS 24Vdc / 24Vdc 2A		8607350000
	MOZ 24Vdc / 24Vdc 2A		8607370000

Information

Screw connection	Type	(Qty.=10)	Order No.
Tension clamp c.	MOS 120Vuc / 24Vdc 2A		8607700000
	MOZ 120Vuc / 24Vdc 2A		8607740000

Information

Screw connection	Type	(Qty.=10)	Order No.
Tension clamp c.	MOS 230Vac / 24Vdc 2A		8607720000
	MOZ 230Vac / 24Vdc 2A		8607760000

Information

Accessories

Information

Pluggable cross-connection ZQV 4N

Pluggable cross-connection ZQV 4N

Pluggable cross-connection ZQV 4N

MICROSERIES

Plug-in solid state relay

SSS Relay

Switching current 100 mA

SSS Relay

Switching current 2 A



Technical data

Input	
	Nominal control voltage
Control voltage	min / max
Control current at $U_{IN} = 24 V$	
Release voltage	
Control circuit resistance	
Output	
Switching voltage	
Switching/continuous current at $U_A > 5 Vdc$	
Conducting-state voltage	
Insulation	
Test voltage between control circuit / switching circuit	
Other data	
Operation temperature range	
Storage temperature range	
Weight	
Approvals	
* Ambient temperature 20°C	
Main-line wiring diagram	
For other data see also http://em.tycoelectronics.com	

24 Vdc	60 Vdc
Control voltage	16 Vdc / 30 Vdc
Control current at $U_{IN} = 24 V$	7 mA \pm 10 %
Release voltage	10 Vdc
Control circuit resistance	ca. 4 kOhm
Control circuit resistance	ca. 20 kOhm
Switching voltage	Bipolar transistor
Switching/continuous current at $U_A > 5 Vdc$	3 ... 48 Vdc
Conducting-state voltage	100 mAdc
Conducting-state voltage	< 1 Vdc
Test voltage between control circuit / switching circuit	2.5 kV
Operation temperature range	-20°C ... +60°C
Storage temperature range	-40°C ... +70°C
Weight	3.65 g
Approvals	

24 Vdc	60 Vdc
Control voltage	18 Vdc / 30 Vdc
Control current at $U_{IN} = 24 V$	7 mA \pm 10 %
Release voltage	10 Vdc
Control circuit resistance	ca. 3.2 kOhm
Control circuit resistance	ca. 16 kOhm
Switching voltage	MOS-FET
Switching/continuous current at $U_A > 5 Vdc$	3 ... 33 Vdc
Conducting-state voltage	2 Adc
Conducting-state voltage	< 120 mVdc
Test voltage between control circuit / switching circuit	2.5 kV
Operation temperature range	-20°C ... +60°C
Storage temperature range	-40°C ... +70°C
Weight	3.65 g
Approvals	

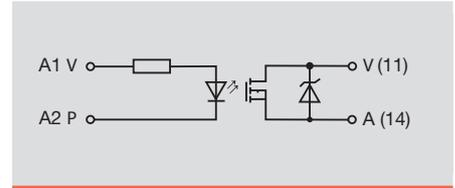
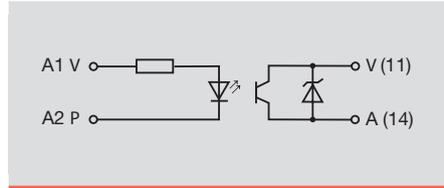

Order data

Nominal control voltage	
24 Vdc	
60 Vdc	

Type	Order no.
SSS Relay 24 V / 24 V 0.1 Adc	4061180000
SSS Relay 60 V / 24 V 0.1 Adc	4061230000

Type	Order no.
SSS Relay 24 V / 24 V 2 Adc	4061190000
SSS Relay 60 V / 24 V 2 Adc	4061200000

Dimensional drawings

Print picture

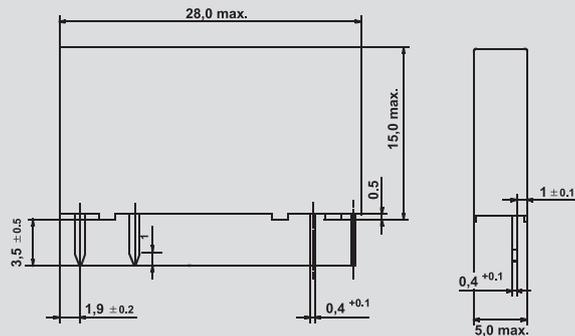
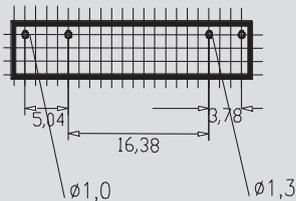

MICROSERIES

Accessories

General data – MICROSERIES

Pluggable cross-connection

Type	No. of poles	Qty	Order no.
Yellow			
ZQV 4N / 2 GE	2	60	1758250000
ZQV 4N / 3 GE	3	60	1762630000
ZQV 4N / 4 GE	4	60	1762620000
ZQV 4N / 10 GE	10	20	1758260000
ZQV 4N / 41 GE	41	10	1758270000
Red			
ZQV 4N / 2 RT	2	60	1793950000
ZQV 4N / 3 RT	3	60	1793980000
ZQV 4N / 4 RT	4	60	1794010000
ZQV 4N / 10 RT	10	20	1794040000
ZQV 4N / 41 RT	41	10	1794070000
Blue			
ZQV 4N / 2 BL	2	60	1793960000
ZQV 4N / 3 BL	3	60	1793990000
ZQV 4N / 4 BL	4	60	1794020000
ZQV 4N / 10 BL	10	20	1794050000
ZQV 4N / 41 BL	41	10	1794080000
Black			
ZQV 4N / 2 SW	2	60	1793970000
ZQV 4N / 3 SW	3	60	1794000000
ZQV 4N / 4 SW	4	60	1794030000
ZQV 4N / 10 SW	10	20	1794060000
ZQV 4N / 41 SW	41	10	1794090000

Technical data

Clamping conductor		Tension clamp connection	Screw connection
Solid H07V-U	mm ²	0.5 ... 2.5	0.5 ... 4.0
Flexible H07V-K	mm ²	0.5 ... 2.5	0.5 ... 2.5
"f" with wire end ferrule as per DIN 46 228 / 1	mm ²	0.5 ... 1.5	0.5 ... 1.5
"f" with wire end ferrule with plastic collar	mm ²	0.5 ... 1.5	0.5 ... 1.5
Max. clamping range	mm ²	0.13 ... 2.5	0.13 ... 4.0
Plug gauge as per IEC 60 947-1	size	A 2	A 3

General technical data

Rated torque		-	0.6
Constant current of the cross-connection 2-pole	A	10	10
Constant current of the cross-connection multi-pole	A	10	10
Stripping length	mm	10	7
Protection		IP 20	IP 20
Enclosure material		Wemid	Wemid
Flammability class as per UL 94		V-0	V-0
Rated current	A	6	6
Rated voltage	V	250	250

Other accessories

Type		Qty	Order no.
Marker			
WS 12/6	12 x 6 mm	200	1061160000
Labels, laser mark			
LM MT 300 15/6 ge	484 labels/Bogen	10	1686360000
Screwdriver			
SD 0.6 x 3.5 x 100		10	9008330000

Dimensioned drawing

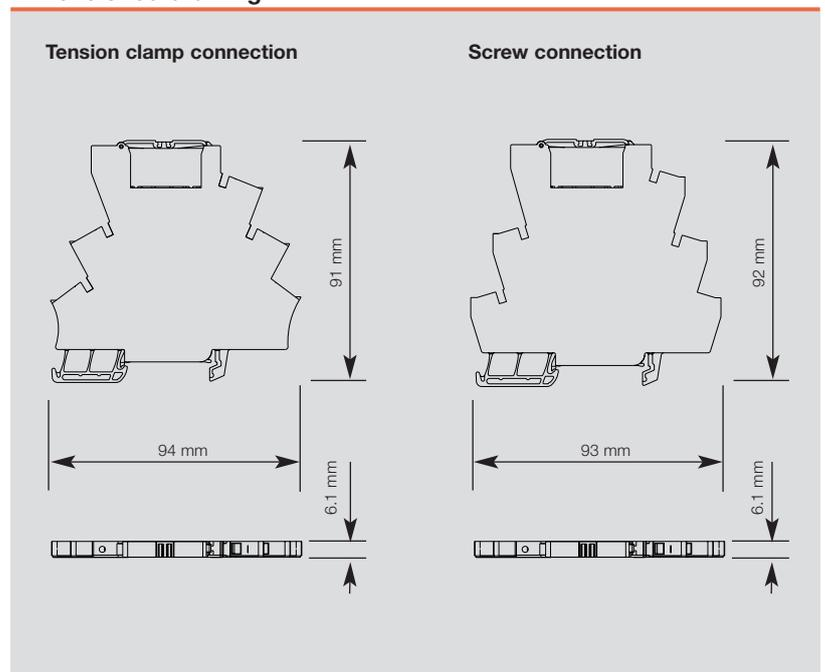

WAVESERIES

Output voltage 24 Vdc, negative switching, wide input range

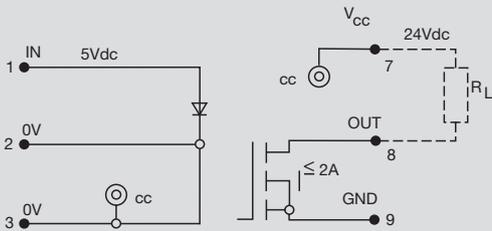

Output			
Output voltage	18 Vdc...24 Vdc...30 Vdc		
Output current (max.)	2A, negative switching		
Voltage drop at max. load			
Block-state curr. (closed circuit curr.)			
Switch-on delay/Switch-off delay	1 ms/6 ms		
Short-circuit proof/Protective circuit	No/varistor		
General data			
Ambient temp., fitted w/o distance	-25 °C...+50 °C		
Ambient temp., fitted w. distance	-25 °C...+50 °C		
Storage temperature	-40 °C...+85 °C		
Approvals	UL/CSA		
Insulation coordinates (EN 50 178)			
Standards	EN 50178		
Rated voltage	300V		
Rated impulse voltage	6.0kV		
Creepage and clearance path input - output	=> 5.5 mm		
Overvoltage category	III		
Pollution severity	2		
Dimensions		Screw connection	Tension clamp connection
Clamping range (rating- / min. / max.)	mm ²	1.5 / 0.5 / 2.5	
Length x width x height	mm	72.0 / 22.5 / 92.4	
Information			

Ordering data

Input

Rated voltage
Rated current
Power rating
Auxiliary voltage
Status indicator

5VDC

4.0 Vdc...5 Vdc...6.0 Vdc
7.5...19mA
30 ...114 mW
No
LED green in input

K

Ordering data

Complete module

Screw connection Type
Order No.
Tension clamp connection Type
Order No.

WOS1 5VDC
8275430000

Ordering data

Spare relay, pluggable

Type
Order No.

Information

WAVESERIES

Output voltage 5-48 Vdc

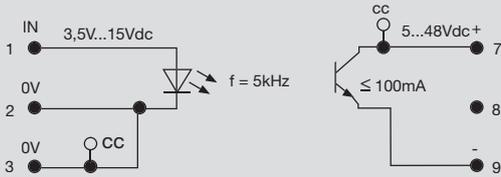

Output	
Output voltage	5 Vdc...48 Vdc
Output current (max.)	100 mA
Voltage drop at max. load	
Block-state curr. (closed circuit curr.)	
Switch-on delay/Switch-off delay	8 ms/35 ms
Short-circuit proof/Protective circuit	No/varistor, integral freewheeling diode
General data	
Ambient temp., fitted w/o distance	-25 °C...+60 °C
Ambient temp., fitted w. distance	-25 °C...+60 °C
Storage temperature	-40 °C...+85 °C
Approvals	UL/CSA
Insulation coordinates (EN 50 178)	
Standards	EN 50178
Rated voltage	300V
Rated impulse voltage	6.0kV
Creepage and clearance path input - output	=> 5.5 mm
Overvoltage category	III
Pollution severity	2
Dimensions	
Clamping range (rating- / min. / max.)	mm ² 1.5 / 0.5 / 2.5
Length x width x height	mm 72.0 / 22.5 / 92.4
Information	

Ordering data

Input	3.5-15VDC 5KHZ
Rated voltage	3.5 Vdc...15 Vdc
Rated current	10...25mA
Power rating	32 ... 375 mW
Auxiliary voltage	No
Status indicator	LED green in input

Ordering data Complete module

Screw connection	Type	WOS1 3.5-15VDC 5KHZ		
	Order No.	8275390000		
Tension clamp connection	Type			
	Order No.			

Ordering data Spare relay, pluggable

	Type			
	Order No.			

Information

--	--	--	--	--

WAVESERIES

Output voltage 24 Vdc, 0.5 A,
short-circuit proof

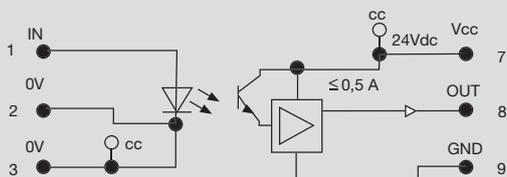
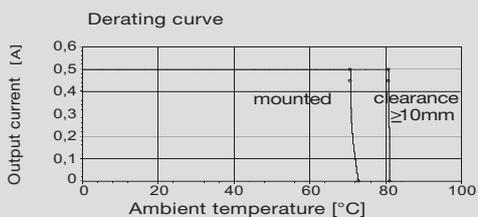

Output	
Output voltage	12 Vdc...24 Vdc...28 Vdc
Output current (max.)	500 mA
Voltage drop at max. load	
Block-state curr. (closed circuit curr.)	
Switch-on delay/Switch-off delay	approx. 10 ms/approx. 20 ms
Short-circuit proof/Protective circuit	Yes/ max. 96 h/varistor, polarity reversal protection
General data	
Ambient temp., fitted w/o distance	-25 °C...+60 °C
Ambient temp., fitted w. distance	-25 °C...+60 °C
Storage temperature	-40 °C...+85 °C
Approvals	UL/CSA
Insulation coordinates (EN 50 178)	
Standards	EN 50178
Rated voltage	300V
Rated impulse voltage	6.0kV
Creepage and clearance path input - output	=> 5.5 mm
Overvoltage category	III
Pollution severity	2
Dimensions	
Clamping range (rating- / min. / max.)	mm ² 1.5 / 0.5 / 2.5
Length x width x height	mm 72.0 / 22.5 / 92.4
Information	

Ordering data

Input	12VUC/24VDC 0.5A	15-60VDC 1KHZ	115VUC/24VDC 0.5A	230VUC/24VDC 0.5A
Rated voltage	10 Vdc...12 Vdc...14 Vdc	15 Vdc...60 Vdc	115 Vuc, max. 130 Vuc	230 Vuc, max. 250 Vuc
Rated current	15mA ac/12mA dc	1.4...4.1mA	2.9mA ac/3.1mA dc	11.5mA ac/1.8mA dc
Power rating	0.18 VA / 0.14 W	21 ... 246 mW	0.16 VA / 0.23 W	2.6 VA / 0.4 W
Auxiliary voltage	No	No	No	No
Status indicator	LED green in output	LED green in output	LED green in output	LED green in output



Ordering data Complete module				
Screw connection Type	WOS1 12VUC	WOS1 15-60VDC 1KHZ	WOS1 115VUC	WOS1 230VUC
Order No.	8275500000	8237730000	8235180000	8275380000
Tension clamp connection Type				
Order No.				
Ordering data Spare relay, pluggable				
Type				
Order No.				
Information				

WAVESERIES

Output voltage 230 Vac, 3.5 A

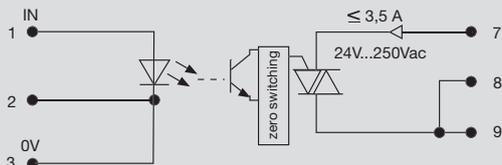
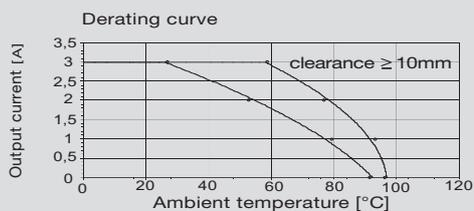

Output	
Output voltage	24 Vac...250 Vac
Output current (max.)	3.5 A
Voltage drop at max. load	
Block-state curr. (closed circuit curr.)	
Switch-on delay/Switch-off delay	max. 20 ms/max. 20 ms
Short-circuit proof/Protective circuit	No/RC-combination with resistor
General data	
Ambient temp., fitted w/o distance	-25 °C...+50 °C
Ambient temp., fitted w. distance	-25 °C...+50 °C
Storage temperature	-40 °C...+85 °C
Approvals	UL/CSA
Insulation coordinates (EN 50 178)	
Standards	EN 50178
Rated voltage	300V
Rated impulse voltage	6.0kV
Creepage and clearance path input - output	=> 5.5 mm
Overvoltage category	III
Pollution severity	2

Dimensions	Screw connection	Tension clamp connection
Clamping range (rating- / min. / max.)	mm ² 1.5 / 0.5 / 2.5	
Length x width x height	mm 92.4 / 22.5 / 112.4	

Information

Ordering data

Input	15-60VUC/24VDC 5A	115VUC/230VAC 3.5A	230VUC/230VAC 3.5A	
Rated voltage	15 Vuc...60 Vac/ 66 Vdc	115 Vuc, max. 130 Vuc	230 Vuc, max. 250 Vuc	
Rated current	3.3...5.3mA ac/3.8...5.6mA dc	3.8mA ac/7.2mA dc	11.8mA ac/3.3mA dc	
Power rating	0.31 VA / 0.33 W	0.44 VA / 0.82 W	2.7 VA / 0.75 W	
Auxiliary voltage	No	No	No	
Status indicator	LED green in input	LED green in input	LED green in input	



Ordering data				
Complete module				
Screw connection	Type	WOS2 15-60VAC 66VDC	WOS2 115VUC	WOS2 230VUC
	Order No.	8275440000	8259950000	8275400000
Tension clamp connection	Type			
	Order No.			
Spare relay, pluggable	Type			
	Order No.			
Information				

WAVESERIES

Output volt. 24 Vdc, 0.5 A,
short-circuit proof, 4 channels

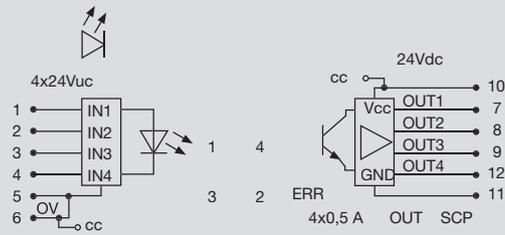
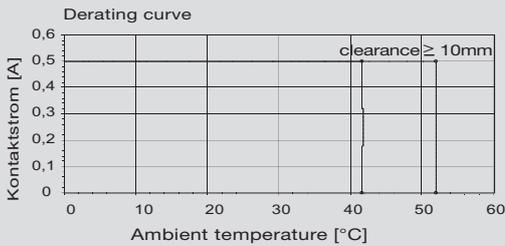

Output	
Output voltage	12 Vdc...24 Vdc...28 Vdc
Output current (max.)	0.5 A per channel
Voltage drop at max. load	
Block-state curr. (closed circuit curr.)	
Switch-on delay/Switch-off delay	<20 ms/<50 ms
Short-circuit proof/Protective circuit	Yes/varistor, polarity reversal protection
General data	
Ambient temp., fitted w/o distance	-25 °C...+50 °C
Ambient temp., fitted w. distance	-25 °C...+50 °C
Storage temperature	-40 °C...+85 °C
Approvals	UL/CSA
Insulation coordinates (EN 50 178)	
Standards	EN 50178
Rated voltage	150V
Rated impulse voltage	6.0kV
Creepage and clearance path input - output	=> 3 mm
Overvoltage category	III
Pollution severity	2
Dimensions	
Clamping range (rating- / min. / max.)	mm ² 1.5 / 0.5 / 2.5
Length x width x height	mm 92.4 / 22.5 / 112.4
Information	

Ordering data

Input

Rated voltage
Rated current
Power rating
Auxiliary voltage
Status indicator

24VUC/24VDC 0.5A

18 Vuc...30 Vuc
2.8mA ac/3.7mA dc
0.4 VA / 0.3 W
No
LED green in output

115VUC/24VDC 0.5A

115 Vuc, max. 130 Vuc
1.4mA ac/2mA dc
0.16 VA / 0.23 W
No
LED green in output

230VUC/24VDC 0.5A

230 Vuc, max. 250 Vuc
1.4mA ac/2mA dc
0.16 VA / 0.23 W
No
LED green in output

Ordering data

Complete module

Screw connection Type
Order No.
Tension clamp connection Type
Order No.

WOS2 24VUC 4C
8237720000

WOS2 115VUC 4C
8275360000

WOS2 230VUC 4C
8275340000

Ordering data

Spare relay, pluggable

Type
Order No.

Information

WAVESERIES

For high switching frequency up to 100kHz

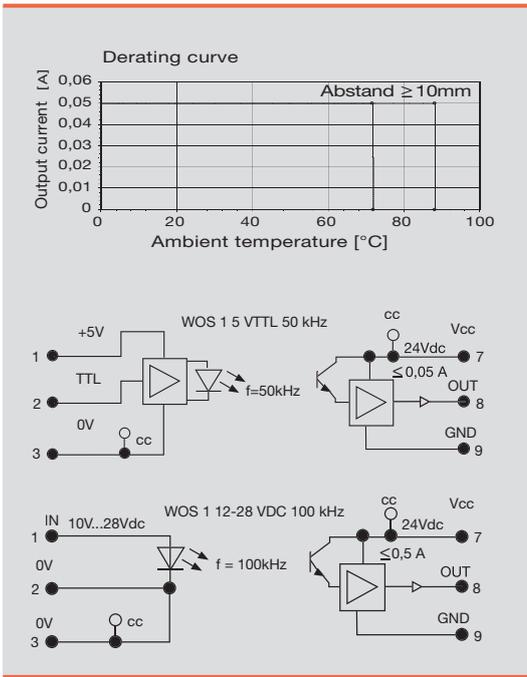

Output			
Output voltage	21.6 Vdc...24 Vdc...26.4 Vdc		
Output current (max.)	50 mA		
Voltage drop at max. load			
Block-state curr. (closed circuit curr.)			
Switch-on delay/Switch-off delay	1 μs/7 μs		
Short-circuit proof/Protective circuit	No/varistor, polarity reversal protection		
General data			
Ambient temp., fitted w/o distance	-25 °C...+60 °C		
Ambient temp., fitted w. distance	-25 °C...+60 °C		
Storage temperature	-40 °C...+85 °C		
Approvals	UL/CSA		
Insulation coordinates (EN 50 178)			
Standards	EN 50178		
Rated voltage	300V		
Rated impulse voltage	6.0kV		
Creepage and clearance path input - output	=> 5.5 mm		
Overvoltage category	III		
Pollution severity	2		
Dimensions		Screw connection	Tension clamp connection
Clamping range (rating- / min. / max.)	mm²	1.5 / 0.5 / 2.5	
Length x width x height	mm	72.0 / 22.5 / 92.4	
Information			

K

Ordering data	5VTTL 50KHZ	12-28VDC 100KHZ		
Input				
Rated voltage	5 V TTL	12 Vdc...28 Vdc		
Rated current	13mA	8mA		
Power rating	65 mW	190 mW		
Auxiliary voltage	5 V	No		
Status indicator	LED green in input	LED green in input		
Ordering data Complete module				
Screw connection	Type	WOS1 5VTTL 50KHZ	WOS1 12-28VDC 100KHZ	
	Order No.	8275210000	8275450000	
Tension clamp connection	Type			
	Order No.			
Ordering data Spare relay, pluggable				
	Type			
	Order No.			
Information				

MCZ-SERIES

MiniConditioner MCZ O

Universal interface between control and sensor/actuator

Direct switching of load currents upto 2A dc

MCZ O with following features:

- Tension clamp connection technology
- Pluggable cross-connection
- Width 6mm

24 VUC

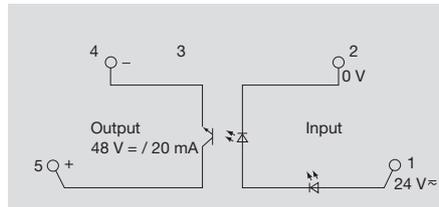
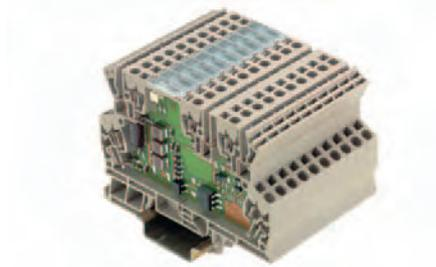

24VUC/24V 2A

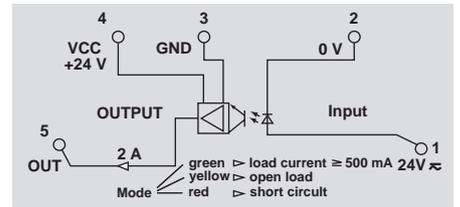
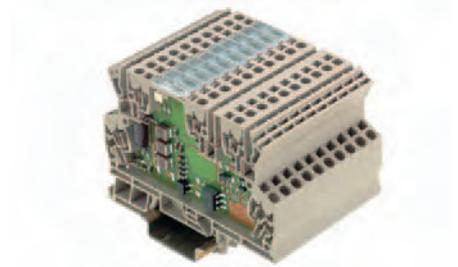

Technical data

Input

Rated voltage
Rated current
Power rating
Max. input frequency
Auxiliary voltage
Status indicator

Output

Output voltage
Output current (max.)
Voltage drop at max. load
Block-state curr. (closed circuit curr.)
Switch-on delay/Switch-off delay
Short-circuit proof/Protective circuit

General data

Ambient temp., fitted w. distance
Ambient temp., fitted w/o distance
Storage temperature
Approvals

Insulation coordinates (EN 50 178)

Standards
Rated voltage
Rated impulse voltage
Creepage and clearance path input - output
Overvoltage category
Pollution severity

24 Vuc +/- 20 %
11mA ac/9mA dc
230mW / 280mVA
dc: 10 Hz/ac: 5 Hz
No
LED green

5...48Vdc
20 mA
< = 1 V

dc 20 ms/ ac 10 ms//ac 45ms/dc 40ms
No/integrated freewheel diode

-25 °C...+50 °C
-25 °C...+50 °C
-40 °C...+85 °C
CE, UL, CSA

EN 50178
300V
6.0kV
>= 5.5 mm
III
2

24 Vuc +/- 20 %
13mA ac/12mA dc
195mW / 220mVA
dc: 30 Hz/ac: 10 Hz
No
LED green

24 Vdc +/- 20%
2 A

/
No/varistor

-25 °C...+40 °C
-25 °C...+40 °C
-40 °C...+60 °C
CE, UL, CSA

EN 50178
300V
6.0kV
>= 5.5 mm
III
2

Dimensions

Clamping range (rating- / min. / max.) mm²
Length x width x height mm

Information

Tension clamp c.

1.50 / 0.50 / 1.50
91.0 x 6.0 x 64.0

CE, UL, CSA
Mounting on TS35

Tension clamp c.

1.50 / 0.50 / 1.50
91.0 x 6.0 x 64.0

CE, UL, CSA
Mounting on TS35

Ordering data

Connection technology

Tension clamp c.

Type Qty. Order No.

MCZ O 24VUC 10 **8365940000**

Type Qty. Order No.

MCZ O 24VUC 10 **8287730000**

Information

Accessories

Information

End plate
AP MCZ1.5 8389030000

End plate
AP MCZ 8389030000

MCZ-SERIES

MiniConditioner MCZ O

Universal interface between control and sensor/actuator

MCZ O with following features:

- Tension clamp connection technology
- Pluggable cross-connection
- Width 6mm

120VUC

230VAC

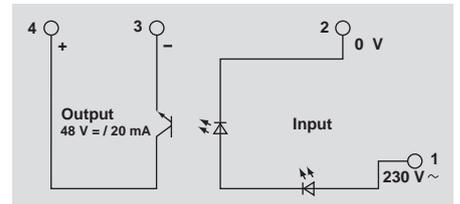
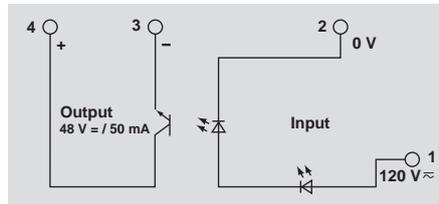
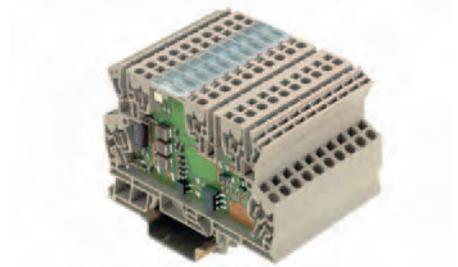
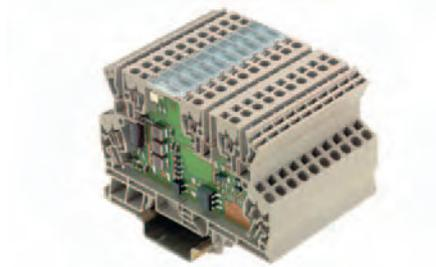

Technical data

Input

Rated voltage
Rated current
Power rating
Max. input frequency
Auxiliary voltage
Status indicator

120 V_{uc} +5/-15 %
3mA
350mW / 400mVA
Ac: 5 Hz duty factor 1:2, dc: 20 Hz duty factor 1:2
No
LED green

230 Vac +5 %/ -15 %
10 mA
2.3 VA
Ac: 5 Hz duty factor 1:2
No
LED green

Output

Output voltage
Output current (max.)
Voltage drop at max. load
Block-state curr. (closed circuit curr.)
Switch-on delay/Switch-off delay
Short-circuit proof/Protective circuit

5...48 Vdc
50 mA
< 1.6 V
0.16 mA
<= 30 ms/<= 40 ms
No/integrated freewheel diode

5...48 Vdc
20 mA
< 1.6 V
0.16 mA
<= 30 ms/<= 40 ms
No/integrated freewheel diode

General data

Ambient temp., fitted w. distance
Ambient temp., fitted w/o distance
Storage temperature
Approvals

-25 °C...+50 °C
-25 °C...+40 °C
-40 °C...+60 °C
CE, UL, CSA

-25 °C...+50 °C
-25 °C...+40 °C
-40 °C...+85 °C
CE, UL, CSA

Insulation coordinates (EN 50 178)

Standards
Rated voltage
Rated impulse voltage
Creepage and clearance path input - output
Overvoltage category
Pollution severity

EN 50178
300V
6.0kV
>= 5.5 mm
III
2

EN 50178
300V
6.0kV
>= 5.5 mm
III
2

Dimensions

Clamping range (rating- / min. / max.) mm²
Length x width x height mm

Tension clamp c.

1.50 / 0.50 / 1.50
91.0 x 6.0 x 64.0

Tension clamp c.

1.50 / 0.50 / 1.50
91.0 x 6.0 x 64.0

Information

CE, UL, CSA
Mounting on TS35

CE, UL, CSA
Mounting on TS35

Ordering data

Connection technology

Tension clamp c.

Type	Qty.	Order No.
MCZ O 120VUC	10	8421060000

Type	Qty.	Order No.
MCZ O 230VAC	10	8421380000

Information

Accessories

Information

End plate
AP MCZ 8389030000

End plate
AP MCZ 8389030000

MCZ-SERIES

MiniConditioner MCZ O

Module can be used as an universal interface:

- Between control and actuator, to convert signals from 24 Vdc to 5 VTTL
- Between control and actuator, to convert signals from 5 VTTL to 5...48 Vdc

24VDC/5VTTL

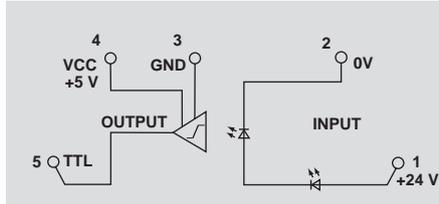
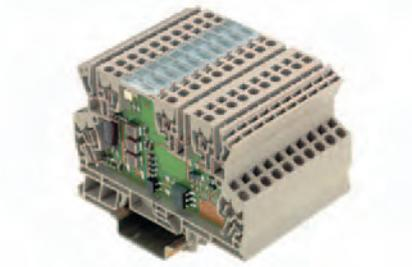

5VTTL/5...48 VDC

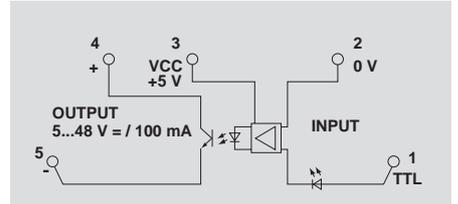
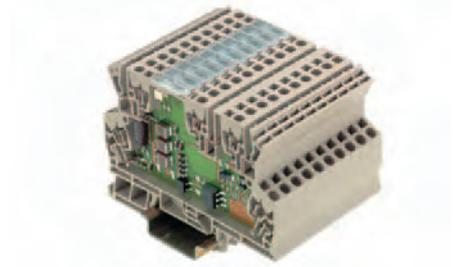

Technical data

Input

Rated voltage	24 Vdc +/- 16 %
Rated current	4.7mA
Power rating	112 mW
Max. input frequency	100 kHz duty factor 1:2, 50 kHz duty factor 1:10
Auxiliary voltage	No
Status indicator	LED green

Output

Output voltage	5 V TTL(4.75...5.25 V)
Output current (max.)	8 mA, fan out = 20 LS-TTL
Voltage drop at max. load	
Block-state curr. (closed circuit curr.)	
Switch-on delay/Switch-off delay	1 µs (at 20 Vdc)/2.5 µs (at 28 Vdc)
Short-circuit proof/Protective circuit	/diode

General data

Ambient temp., fitted w. distance	-25 °C...+50 °C
Ambient temp., fitted w/o distance	-25 °C...+40 °C
Storage temperature	-40 °C...+60 °C
Approvals	CE, UL, CSA

Insulation coordinates (EN 50 178)

Standards	EN 50178
Rated voltage	300V
Rated impulse voltage	6.0kV
Creepage and clearance path input - output	>= 5.5 mm
Overvoltage category	III
Pollution severity	2

Input

Rated voltage	5 V TTL
Rated current	1µA
Power rating	10 mW
Max. input frequency	2.4 kHz
Auxiliary voltage	5 V
Status indicator	LED green

Output

Output voltage	5...48Vdc
Output current (max.)	100 mA
Voltage drop at max. load	< =1.8
Block-state curr. (closed circuit curr.)	
Switch-on delay/Switch-off delay	/
Short-circuit proof/Protective circuit	/diode

General data

Ambient temp., fitted w. distance	-25 °C...+50 °C
Ambient temp., fitted w/o distance	-25 °C...+50 °C
Storage temperature	-40 °C...+85 °C
Approvals	CE, UL, CSA

Insulation coordinates (EN 50 178)

Standards	EN 50178
Rated voltage	300V
Rated impulse voltage	6.0kV
Creepage and clearance path input - output	>= 5.5 mm
Overvoltage category	III
Pollution severity	2

Dimensions

Clamping range (rating- / min. / max.)	mm²
Length x width x height	mm

Information

Tension clamp c.

1.50 / 0.50 / 1.50
91.0 x 6.0 x 64.0

CE, UL, CSA
Mounting on TS35

Tension clamp c.

1.50 / 0.50 / 1.50
91.0 x 6.0 x 64.0

CE, UL, CSA
Mounting on TS35

Ordering data

Connection technology

Tension clamp c.

Type	Qty.	Order No.
MCZ O 24VDC	10	8324610000

Type	Qty.	Order No.
MCZ O 5VTTL	10	8398940000

Information

Accessories

Information

End plate
AP MCZ 8389030000

End plate
AP MCZ 8389030000

DK-SERIES

Minicoupler DKO

- Coupling of digital sensor-/actuator signals between PLC and process
- Low-cost solution for adaption of level and potential
- Low input power
- Screw connection technology
- 6 mm width
- Mounting on TS35

5VDC

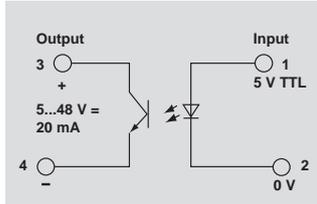
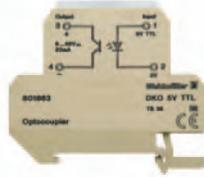

5VTTL

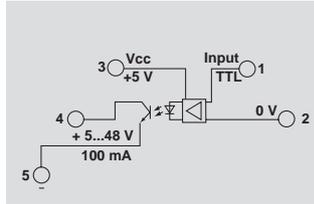
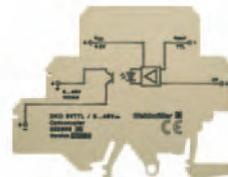

12VDC 10 KHZ

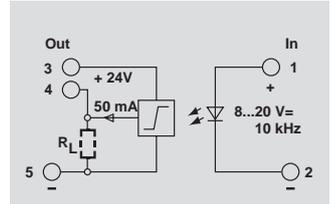
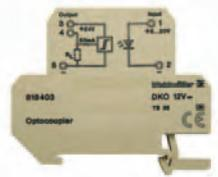

Technical data

Input

Rated voltage	5 Vdc +/- 5 %
Rated current	10 mA
Power rating	50 mW
Max. input frequency	20 Hz
Auxiliary voltage	No
Status indicator	LED green

Output

Output voltage	5...48 Vdc
Output current (max.)	20 mA
Voltage drop at max. load	< 1.6 V
Block-state curr. (closed circuit curr.)	50 µA
Switch-on delay/Switch-off delay	<= 15 µs / <= 70 µs
Short-circuit proof/Protective circuit	No/diode

General data

Ambient temp., fitted w. distance	-25 °C...+50 °C
Ambient temp., fitted w/o distance	-25 °C...+40 °C
Storage temperature	-40 °C...+85 °C
Approvals	CE

Insulation coordinates (EN 50 178)

Standards	EN 50178
Rated voltage	150V
Rated impulse voltage	4.0kV
Creepage and clearance path input - output	>= 4 mm
Overvoltage category	IV
Pollution severity	2

Rated voltage	5 V TTL
Rated current	1 µA
Power rating	50µW
Max. input frequency	3 kHz
Auxiliary voltage	5 V
Status indicator	LED green

Output voltage	5...48 Vdc
Output current (max.)	100 mA
Voltage drop at max. load	<= 1.6 V
Block-state curr. (closed circuit curr.)	<= 50 µA
Switch-on delay/Switch-off delay	approx. 27 µs / approx. 35 µs
Short-circuit proof/Protective circuit	No/diode

Ambient temp., fitted w. distance	-25 °C...+50 °C
Ambient temp., fitted w/o distance	-25 °C...+40 °C
Storage temperature	-40 °C...+85 °C
Approvals	CE

Standards	EN 50178
Rated voltage	300V
Rated impulse voltage	6.0kV
Creepage and clearance path input - output	>= 5.5 mm
Overvoltage category	IV
Pollution severity	2

Rated voltage	12 Vdc +/- 20 %
Rated current	11 mA
Power rating	max. 130 mW
Max. input frequency	max. 10 kHz
Auxiliary voltage	No
Status indicator	LED green

Output voltage	24 Vdc +/- 10%
Output current (max.)	50 mA
Voltage drop at max. load	< 1 V
Block-state curr. (closed circuit curr.)	<= 50 µA
Switch-on delay/Switch-off delay	1 µs / 2.5 µs
Short-circuit proof/Protective circuit	No/diode

Ambient temp., fitted w. distance	-25 °C...+50 °C
Ambient temp., fitted w/o distance	-25 °C...+40 °C
Storage temperature	-40 °C...+85 °C
Approvals	CE

Standards	EN 50178
Rated voltage	300V
Rated impulse voltage	6.0kV
Creepage and clearance path input - output	>= 5.5 mm
Overvoltage category	IV
Pollution severity	2

Dimensions

Clamping range (rating- / min. / max.)	mm ²
Length x width x height	mm

Information

Screw connection

4 / 0.50 / 4
65.0 x 6.0 x 57.0

Screw connection

4 / 0.50 / 4
77.0 x 6.0 x 62.0

Screw connection

4 / 0.50 / 4
65.0 x 12.0 x 57.0

Ordering data

Connection technology

Screw connection

Type	(Qty.=10)	Order No.
DKO 35 5VDC		8018630000

Type	(Qty.=10)	Order No.
DKO 55 5VTTL		8228650000

Type	(Qty.=10)	Order No.
DKO 45 12VDC 10KHZ		8184030000

Information

Input bottom

Input bottom

Input bottom

Accessories

Information

End plate	AP DK4 0687560000
-----------	-------------------

End plate	AP DK5 8268870000
-----------	-------------------

End plate	AP DK4 0687560000
-----------	-------------------

DK-SERIES

Minicoupler DKO

- Coupling of digital sensor-/actuator signals between PLC and process
- Low-cost solution for adaption of level and potential
- Low input power
- Screw connection technology
- 6 mm width
- Mounting on TS35

24VUC

24VDC 3KHZ

24VDC 3KHZ

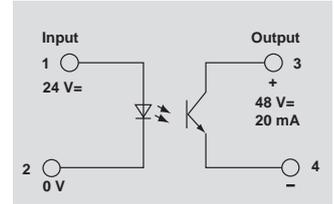
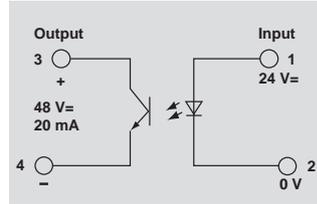
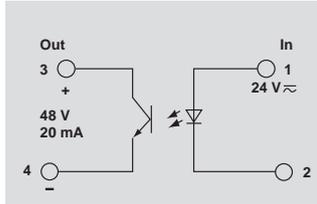
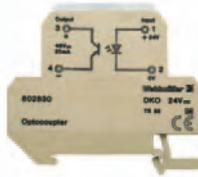
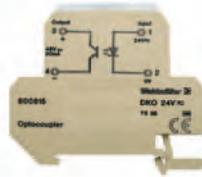

Technical data

Input

Rated voltage
Rated current
Power rating
Max. input frequency
Auxiliary voltage
Status indicator

24 Vdc +/- 10 %
11.4 mA ac / 9.6 mA dc
280 mVA / 230 mW
10 Hz at dc
No
LED green

24 Vdc +/- 10 %
<= 15 mA
max. 360 mW
3 kHz
No
LED green

24 Vdc +/- 10 %
<= 15 mA
max. 360 mW
3 kHz
No
LED green

Output

Output voltage
Output current (max.)
Voltage drop at max. load
Block-state curr. (closed circuit curr.)
Switch-on delay/Switch-off delay
Short-circuit proof/Protective circuit

5...48 Vdc
20 mA
<= 1 V
<= 50 µA
<= 15 ms at dc / <= 25 ms at dc
No/diode

5...48 Vdc
20 mA
<= 900 mV
0.16 mA
approx. 50 µs / approx. 80 µs
No/diode

5...48 Vdc
20 mA
<= 900 mV
50 µA
approx. 50 µs / approx. 80 µs
No/diode

General data

Ambient temp., fitted w. distance
Ambient temp., fitted w/o distance
Storage temperature
Approvals

-25 °C...+50 °C
-25 °C...+40 °C
-40 °C...+85 °C
CE

-25 °C...+50 °C
-25 °C...+40 °C
-40 °C...+85 °C
CE

-25 °C...+50 °C
-25 °C...+40 °C
-40 °C...+85 °C
CE

Insulation coordinates (EN 50 178)

Standards
Rated voltage
Rated impulse voltage
Creepage and clearance path input - output
Overvoltage category
Pollution severity

EN 50178
300V
4.0kV
>= 4 mm
III
2

EN 50178
300V
4.0kV
>= 4 mm
III
2

EN 50178
300V
4.0kV
>= 4 mm
III
2

Dimensions

Clamping range (rating- / min. / max.) mm²
Length x width x height mm

Screw connection

4 / 0.50 / 4
65.0 x 6.0 x 57.0

Screw connection

4 / 0.50 / 4
65.0 x 6.0 x 57.0

Screw connection

4 / 0.50 / 4
65.0 x 6.0 x 57.0

Information

Ordering data

Connection technology

Screw connection

Type	(Qty.=10)	Order No.
DKO 35 24VUC		8008150000

Type	(Qty.=10)	Order No.
DKO 35 24VDC 3KHZ E.U		8028300000

Type	(Qty.=10)	Order No.
DKO 35 24VDC 3KHZ E:O		8215640000

Information

Input bottom

Input bottom

Input top

Accessories

Information

End plate
AP DK4 0687560000

End plate
AP DK4 0687560000

End plate
AP DK4 0687560000

DK-SERIES

Minicoupler DKO

- Coupling of digital sensor-/actuator signals between PLC and process
- Low-cost solution for adaption of level and potential
- Low input power
- Screw connection technology
- 6 mm width
- Mounting on TS35

24VDC 3KHZ

24VDC 100Hz

24VDC 100Hz

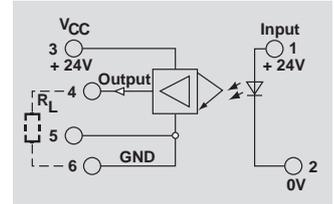
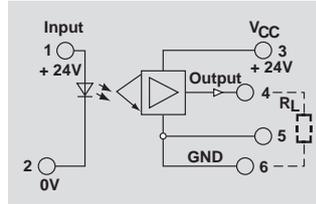
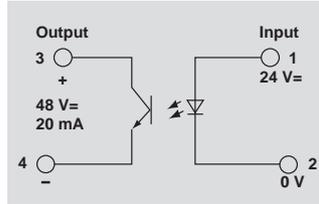

Technical data

Input

Rated voltage	24 Vdc +/- 10 %
Rated current	8.5 mA
Power rating	max. 204 mW
Max. input frequency	3 kHz
Auxiliary voltage	No
Status indicator	LED green

Output

Output voltage	5...48 Vdc
Output current (max.)	20 mA
Voltage drop at max. load	<= 900 mV
Block-state curr. (closed circuit curr.)	50 µA
Switch-on delay/Switch-off delay	approx. 50 µs/approx. 80 µs
Short-circuit proof/Protective circuit	No/diode

General data

Ambient temp., fitted w. distance	-25 °C...+50 °C
Ambient temp., fitted w/o distance	-25 °C...+40 °C
Storage temperature	-40 °C...+85 °C
Approvals	CE

Insulation coordinates (EN 50 178)

Standards	EN 50178
Rated voltage	300V
Rated impulse voltage	4.0kV
Creepage and clearance path input - output	>= 4 mm
Overvoltage category	III
Pollution severity	2

Rated voltage	24 Vdc +/- 10 %
Rated current	12 mA
Power rating	max. 290 mW
Max. input frequency	100 Hz
Auxiliary voltage	No
Status indicator	LED green

Output voltage	24 Vdc +/- 10%
Output current (max.)	2 A
Voltage drop at max. load	
Block-state curr. (closed circuit curr.)	
Switch-on delay/Switch-off delay	2 ms/7 ms
Short-circuit proof/Protective circuit	No/varistor

Ambient temp., fitted w. distance	-25 °C...+50 °C
Ambient temp., fitted w/o distance	-25 °C...+40 °C
Storage temperature	-40 °C...+85 °C
Approvals	CE

Standards	EN 50178
Rated voltage	300V
Rated impulse voltage	4.0kV
Creepage and clearance path input - output	>= 3 mm
Overvoltage category	III
Pollution severity	2

Rated voltage	24 Vdc +/- 10 %
Rated current	12 mA
Power rating	max. 290 mW
Max. input frequency	100 Hz
Auxiliary voltage	No
Status indicator	LED green

Output voltage	24 Vdc +/- 10%
Output current (max.)	2 A
Voltage drop at max. load	
Block-state curr. (closed circuit curr.)	
Switch-on delay/Switch-off delay	2 ms/7 ms
Short-circuit proof/Protective circuit	No/diode

Ambient temp., fitted w. distance	-25 °C...+50 °C
Ambient temp., fitted w/o distance	-25 °C...+40 °C
Storage temperature	-40 °C...+85 °C
Approvals	CE

Standards	EN 50178
Rated voltage	300V
Rated impulse voltage	4.0kV
Creepage and clearance path input - output	>= 3 mm
Overvoltage category	III
Pollution severity	2

Dimensions

Clamping range (rating- / min. / max.)	mm ²
Length x width x height	mm

Information

Screw connection

4 / 0.50 / 4
65.0 x 6.0 x 57.0

Screw connection

4 / 0.50 / 4
65.0 x 12.0 x 57.0

Screw connection

4 / 0.50 / 4
65.0 x 12.0 x 57.0

Ordering data

Connection technology

Screw connection

Type	(Qty.=10)	Order No.
DKO 35 24VDC 3KHZ E:U		8248790000

Type	(Qty.=10)	Order No.
DKO 35 24VDC E:U		8181990000

Type	(Qty.=10)	Order No.
DKO 35 24VDC E:O		8215600000

Information

Input bottom

Input bottom

Input top

Accessories

Information

End plate	AP DK4 0687560000
-----------	-------------------

End plate	AP DK4 0687560000
-----------	-------------------

End plate	AP DK4 0687560000
-----------	-------------------

DK-SERIES

Minicoupler DKO

- Coupling of digital sensor-/actuator signals between PLC and process
- Low-cost solution for adaption of level and potential
- Low input power
- Screw connection technology
- 6 mm width
- Mounting on TS35

24VDC 200Hz

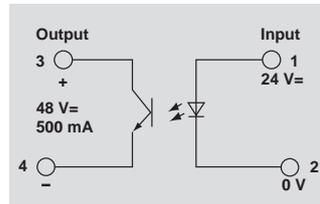
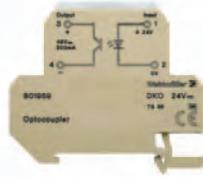

24VDC 200Hz

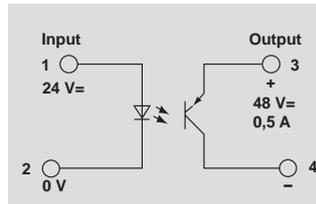
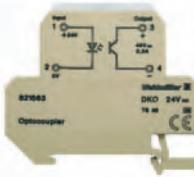

24VDC 50KHZ

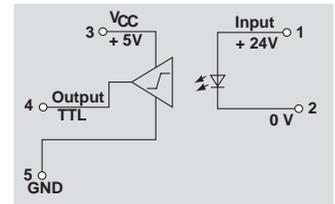
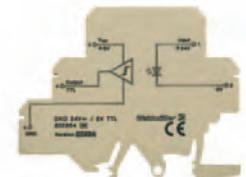

Technical data

Input

Rated voltage
Rated current
Power rating
Max. input frequency
Auxiliary voltage
Status indicator

24 Vdc +/- 10 %
6 mA
145 mW
200 Hz
No
LED green

24 Vdc +/- 10 %
6 mA
max. 145 mW
200Hz
No
LED green

24 Vdc +/- 20 %
4.7 mA
max. 112 mW
100kHz
No
LED green

Output

Output voltage
Output current (max.)
Voltage drop at max. load
Block-state curr. (closed circuit curr.)
Switch-on delay/Switch-off delay
Short-circuit proof/Protective circuit

5...48 Vdc
500 mA
< = 800 mV
approx. 40 µs/approx. 65 µs
No/diode

5...48 Vdc
500 mA
< = 800 mV
< = 10µA
approx. 40 µs/approx. 65 µs
No/diode

5 VTTL
8 mA, fan out=20 LS-TTL
1 µs/2.5 µs
No/diode

General data

Ambient temp., fitted w. distance
Ambient temp., fitted w/o distance
Storage temperature
Approvals

-25 °C...+50 °C
-25 °C...+40 °C
-40 °C...+85 °C
CE

-25 °C...+50 °C
-25 °C...+40 °C
-40 °C...+85 °C
CE

-25 °C...+50 °C
-25 °C...+40 °C
-25 °C...+85 °C
CE

Insulation coordinates (EN 50 178)

Standards
Rated voltage
Rated impulse voltage
Creepage and clearance path input - output
Overvoltage category
Pollution severity

EN 50178
300V
4.0kV
>= 4 mm
III
2

EN 50178
300V
4.0kV
>= 4 mm
III
2

EN 50178
300V
4.0kV
>= 5.5 mm
III
2

Dimensions

Clamping range (rating- / min. / max.) mm²
Length x width x height mm

Screw connection

4 / 0.50 / 4
65.0 x 6.0 x 57.0

Screw connection

4 / 0.50 / 4
65.0 x 6.0 x 57.0

Screw connection

4 / 0.50 / 4
77.0 x 6.0 x 62.0

Information

Ordering data

Connection technology

Screw connection

Type	(Qty.=10)	Order No.
DKO 35 24VDC E:U		8019590000

Type	(Qty.=10)	Order No.
DKO 35 24VDC E:O		8215630000

Type	(Qty.=10)	Order No.
DKO DK5 24VDC 50KHZ		8228640000

Information

Input bottom

Input top

Input top

Accessories

Information

End plate
AP DK4 0687560000

End plate
AP DK4 0687560000

End plate
AP DK5 8268870000

DK-SERIES

Minicoupler DKO

- Coupling of digital sensor-/actuator signals between PLC and process
- Low-cost solution for adaption of level and potential
- Low input power
- Screw connection technology
- 6 mm width
- Mounting on TS35

24VUC

115VUC

230VUC

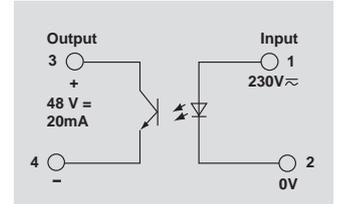
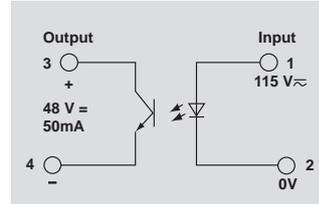
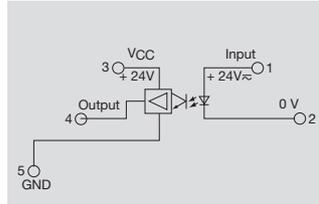
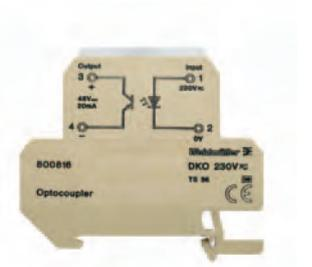

Technical data

Input

Rated voltage	24 Vuc +/- 20 %
Rated current	13 mA ac / 12 mA dc
Power rating	max.: 220 mVA / 195 mW
Max. input frequency	<=; 10 Hz
Auxiliary voltage	No
Status indicator	LED green

Output

Output voltage	24 Vdc +/- 20%
Output current (max.)	2 A
Voltage drop at max. load	
Block-state curr. (closed circuit curr.)	
Switch-on delay/Switch-off delay	2 ms/7 ms
Short-circuit proof/Protective circuit	No/

General data

Ambient temp., fitted w. distance	-25 °C...+50 °C
Ambient temp., fitted w/o distance	-25 °C...+40 °C
Storage temperature	-40 °C...+85 °C
Approvals	CE

Insulation coordinates (EN 50 178)

Standards	EN 50178
Rated voltage	300V
Rated impulse voltage	6.0kV
Creepage and clearance path input - output	>= 5.5 mm
Overvoltage category	IV
Pollution severity	2

Rated voltage	115 Vuc +5 %/-15 %
Rated current	2.65 mA ac / 3 mA dc
Power rating	390 mVA / 350 mW
Max. input frequency	20Hz dc, 5Hz ac
Auxiliary voltage	No
Status indicator	LED green

Output voltage	5...48 Vdc
Output current (max.)	50 mA
Voltage drop at max. load	< 1.6 V
Block-state curr. (closed circuit curr.)	0.16 mA
Switch-on delay/Switch-off delay	17.4 ms/27.4 ms
Short-circuit proof/Protective circuit	No/diode

Ambient temp., fitted w. distance	-25 °C...+50 °C
Ambient temp., fitted w/o distance	-25 °C...+40 °C
Storage temperature	-40 °C...+85 °C
Approvals	CE

Standards	EN 50178
Rated voltage	300V
Rated impulse voltage	6.0kV
Creepage and clearance path input - output	>= 5.5 mm
Overvoltage category	IV
Pollution severity	2

Rated voltage	230 Vuc +5 %/-15 %
Rated current	1.8 mA ac / 1.7 mA dc
Power rating	395 mVA / 370 mW
Max. input frequency	20Hz dc, 5Hz ac
Auxiliary voltage	No
Status indicator	LED green

Output voltage	5...48 Vdc
Output current (max.)	20 mA
Voltage drop at max. load	< 1.6 V
Block-state curr. (closed circuit curr.)	0.16 mA
Switch-on delay/Switch-off delay	20 ms/20 ms
Short-circuit proof/Protective circuit	No/diode

Ambient temp., fitted w. distance	-25 °C...+50 °C
Ambient temp., fitted w/o distance	-25 °C...+50 °C
Storage temperature	-40 °C...+85 °C
Approvals	CE

Standards	EN 50178
Rated voltage	300V
Rated impulse voltage	6.0kV
Creepage and clearance path input - output	>= 5.5 mm
Overvoltage category	III
Pollution severity	2

Dimensions

Clamping range (rating- / min. / max.)	mm ²
Length x width x height	mm

Information

Screw connection

4 / 0.50 / 4
77.0 x 6.0 x 62.0

Screw connection

4 / 0.50 / 4
65.0 x 6.0 x 57.0

Screw connection

4 / 0.50 / 4
65.0 x 6.0 x 57.0

Ordering data

Connection technology

Screw connection

Type	(Qty.=10)	Order No.
DKO DK5 24VUC		8228630000

Type	(Qty.=10)	Order No.
DKO 35 115VUC		8077860000

Type	(Qty.=10)	Order No.
DKO 35 230VUC		8008160000

Information

Input bottom

Input bottom

Input bottom

Accessories

Information

End plate	AP DK5	8268870000
-----------	--------	------------

End plate	AP DK4	0687560000
-----------	--------	------------

End plate	AP DK4	0687560000
-----------	--------	------------

EG-SERIES

EG 7

- Combination foot for TS15, TS32 or TS35
- Optional pluggable on clip-in base RS EG7
- Width 10 mm
- Protective separation according to VDE 0884

5VDC

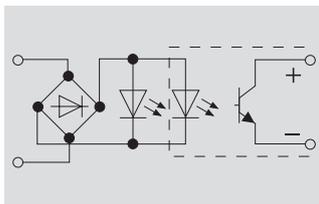
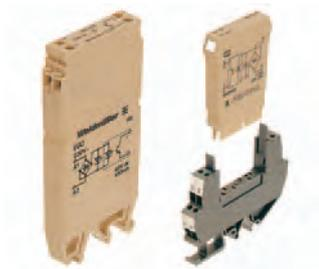

12VUC

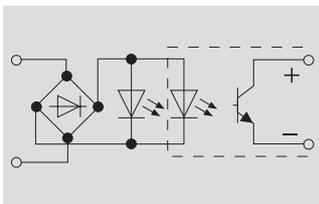
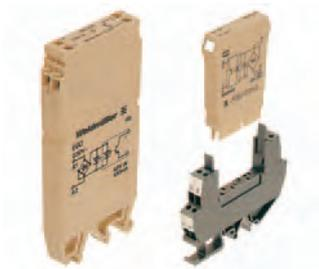

24VUC

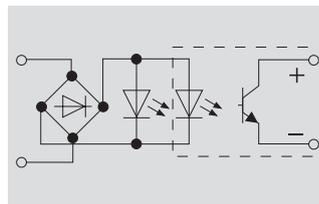
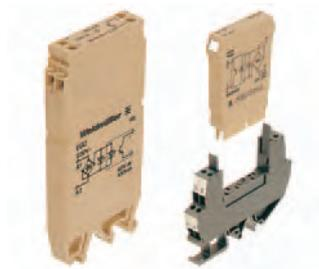

Technical data

Input	5 Vdc +/- 20 %	12 Vuc +/- 20 %	24 Vuc +/- 20 %
Rated voltage	5 Vdc +/- 20 %	12 Vuc +/- 20 %	24 Vuc +/- 20 %
Rated current	6.8 mA	33mA ac/30mA dc	3.4 mA dc/2.8 mA ac
Power rating	40 mW	40 mW / 50 mVA	70 mW / 90 mVA
Max. input frequency	15Hz	15Hz	15Hz
Auxiliary voltage	No	No	No
Status indicator	LED green	LED green	LED green
Output			
Output voltage	5...48Vdc	5...48Vdc	5...48Vdc
Output current (max.)	100 mA	100 mA	100 mA
Voltage drop at max. load	< 1.5 V	< 1.5 V	< 1.5 V
Block-state curr. (closed circuit curr.)	< =50 µA	< =50 µA	< =50 µA
Switch-on delay/Switch-off delay	6ms/12ms	6ms/12ms	5ms/15ms
Short-circuit proof/Protective circuit	No/integrated freewheel diode	No/integrated freewheel diode	No/integrated freewheel diode
General data			
Ambient temp., fitted w. distance	-25 °C...+60 °C	-25 °C...+60 °C	-25 °C...+60 °C
Ambient temp., fitted w/o distance	-25 °C...+60 °C	-25 °C...+60 °C	-25 °C...+60 °C
Storage temperature	-40 °C...+60 °C	-40 °C...+60 °C	-40 °C...+60 °C
Approvals	CE	CE	CE
Insulation coordinates (EN 50 178)			
Standards	EN 50178	EN 50178	EN 50178
Rated voltage	300V	300V	300V
Rated impulse voltage	6.0kV	6.0kV	6.0kV
Creepage and clearance path input - output	>= 5.5 mm	>= 5.5 mm	>= 5.5 mm
Overvoltage category	III	III	III
Pollution severity	2	2	2

Dimensions	Complete module		Pluggable	
	mm	mm	mm	mm
Clamping range (rating- / min. / max.)	1.50 / 0.50 / 1.50	2.50 / 0.50 / 2.50	1.50 / 0.50 / 1.50	2.50 / 0.50 / 2.50
Length x width x height	44.0 x 10.0 x 96.0	95.0 x 10.0 x 99.0	44.0 x 10.0 x 96.0	95.0 x 10.0 x 99.0
Information	Dimensions pluggable opto-coupler incl. locking socket RS EG7		Dimensions pluggable opto-coupler incl. locking socket RS EG7	

Ordering data

Article description	Type	(Qty.=10)	Order No.	Type	(Qty.=10)	Order No.	Type	(Qty.=10)	Order No.
Complete module	EGO EG7 5VDC K-FU		8092490000	EGO EG7 12VUC K-FU		8092510000	EGO EG7 24VUC K-FU		8092530000
	Pluggable		8234560000	OST EG7 12VUC		8234570000	OST EG7 24VUC		8234580000
Information									

Accessories

Information	Locking socket	Locking socket	Locking socket
	RS EG7 8193830000	RS EG7 8193830000	RS EG7 8193830000

EG-SERIES

EG 7

- Combination foot for TS15, TS32 or TS35
- Optional pluggable on clip-in base RS EG7
- Width 10 mm
- Protective separation according to VDE 0884

48VUC

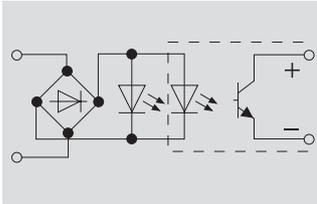
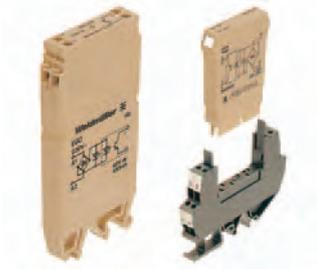

115VUC

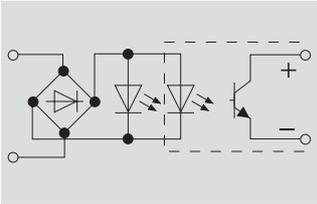
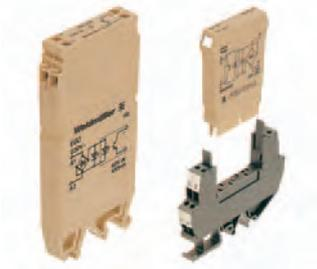

230VAC

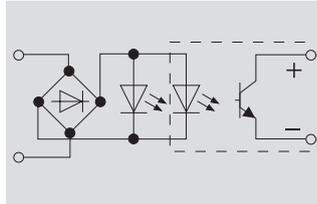

Technical data

Input

Rated voltage	48 Vuc +/- 20 %
Rated current	3.4mA ac/2.8mA dc
Power rating	135 mW</br>155 mVA
Max. input frequency	15Hz
Auxiliary voltage	No
Status indicator	LED green

Output

Output voltage	5...48Vdc
Output current (max.)	100 mA
Voltage drop at max. load	< 1.5 V
Block-state curr. (closed circuit curr.)	< =50 µA
Switch-on delay/Switch-off delay	5ms/15ms
Short-circuit proof/Protective circuit	No/integrated freewheel diode

General data

Ambient temp., fitted w. distance	-25 °C...+60 °C
Ambient temp., fitted w/o distance	-25 °C...+60 °C
Storage temperature	-40 °C...+60 °C
Approvals	CE

Insulation coordinates (EN 50 178)

Standards	EN 50178
Rated voltage	300V
Rated impulse voltage	6.0kV
Creepage and clearance path input - output	>= 5.5 mm
Overvoltage category	III
Pollution severity	2

Rated voltage	115 Vuc +/- 20 %
Rated current	9mA ac/3.3mA dc
Power rating	0.4 W / 0.5 VA
Max. input frequency	12Hz
Auxiliary voltage	No
Status indicator	LED green

Output voltage	5...48Vdc
Output current (max.)	100 mA
Voltage drop at max. load	< 1.5 V
Block-state curr. (closed circuit curr.)	< =50 µA
Switch-on delay/Switch-off delay	9ms/25ms
Short-circuit proof/Protective circuit	No/integrated freewheel diode

Ambient temp., fitted w. distance	-25 °C...+60 °C
Ambient temp., fitted w/o distance	-25 °C...+60 °C
Storage temperature	-40 °C...+60 °C
Approvals	CE

Standards	EN 50178
Rated voltage	300V
Rated impulse voltage	6.0kV
Creepage and clearance path input - output	>= 5.5 mm
Overvoltage category	III
Pollution severity	2

Rated voltage	230 Vac +6/-15 %
Rated current	14mA
Power rating	3.2 VA
Max. input frequency	12Hz
Auxiliary voltage	No
Status indicator	LED green

Output voltage	5...48Vdc
Output current (max.)	100 mA
Voltage drop at max. load	< 1.5 V
Block-state curr. (closed circuit curr.)	< =50 µA
Switch-on delay/Switch-off delay	15ms/15ms
Short-circuit proof/Protective circuit	No/integrated freewheel diode

Ambient temp., fitted w. distance	-25 °C...+60 °C
Ambient temp., fitted w/o distance	-25 °C...+60 °C
Storage temperature	-40 °C...+60 °C
Approvals	CE

Standards	EN 50178
Rated voltage	300V
Rated impulse voltage	6.0kV
Creepage and clearance path input - output	>= 5.5 mm
Overvoltage category	III
Pollution severity	2

Dimensions

Clamping range (rating- / min. / max.)	mm²
Length x width x height	mm

Information

Complete module	Pluggable
1.50 / 0.50 / 1.50	2.50 / 0.50 / 2.50
44.0 x 10.0 x 96.0	95.0 x 10.0 x 99.0

Dimensions pluggable opto-coupler incl. locking socket RS EG7

Complete module	Pluggable
1.50 / 0.50 / 1.50	2.50 / 0.50 / 2.50
44.0 x 10.0 x 96.0	95.0 x 10.0 x 99.0

Dimensions pluggable opto-coupler incl. locking socket RS EG7

Complete module	Pluggable
1.50 / 0.50 / 1.50	2.50 / 0.50 / 2.50
44.0 x 10.0 x 96.0	95.0 x 10.0 x 99.0

Dimensions pluggable opto-coupler incl. locking socket RS EG7

Ordering data

Article description	Type	(Qty.=10)	Order No.
Complete module	EGO EG7 48VUC K-FU		8092550000
Pluggable	OST EG7 48VUC		8234590000

Information

Type	(Qty.=10)	Order No.
EGO EG7 115VUC K-FU		8092570000
OST EG7 115VUC		8234600000

Type	(Qty.=10)	Order No.
EGO EG7 230VAC K-FU		8092590000
OST EG7 230VAC		8234610000

Type	(Qty.=10)	Order No.
EGO EG7 230VAC K-FU		8092590000
OST EG7 230VAC		8234610000

Accessories

Information
Locking socket RS EG7 8193830000

Information
Locking socket RS EG7 8193830000

Information
Locking socket RS EG7 8193830000

Information
Locking socket RS EG7 8193830000

EG-SERIES

For long control wires

For long control wires

- RC-Input circuit to disable interfering signals
- Safe switching behavior in case of interfering pulses on the control side

230VAC RC

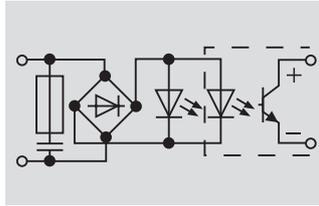

Technical data

Input

Rated voltage	230 Vac +6/-15 %
Rated current	3.8mA
Power rating	870 mVA
Max. input frequency	12Hz
Auxiliary voltage	No
Status indicator	LED green

Output

Output voltage	5...48Vdc
Output current (max.)	100 mA
Voltage drop at max. load	< 1.5 V
Block-state curr. (closed circuit curr.)	< =50 µA
Switch-on delay/Switch-off delay	5ms/18ms
Short-circuit proof/Protective circuit	No/varistor, integral freewheeling diode

General data

Ambient temp., fitted w. distance	-25 °C...+60 °C
Ambient temp., fitted w/o distance	-25 °C...+60 °C
Storage temperature	-40 °C...+60 °C
Approvals	CE

Insulation coordinates (EN 50 178)

Standards	EN 50178
Rated voltage	300V
Rated impulse voltage	6.0kV
Creepage and clearance path input - output	>= 5.5 mm
Overtoltage category	III
Pollution severity	2

Dimensions

	Complete module	Pluggable
Clamping range (rating- / min. / max.)	1.50 / 0.50 / 1.50	2.50 / 0.50 / 2.50
Length x width x height	44.0 x 10.0 x 96.0	95.0 x 10.0 x 99.0

Information

Dimensions pluggable opto-coupler
incl. locking socket RS EG7

Ordering data

Article description	Type	(Qty.=10)	Order No.
Complete module	EGO EG7 RC 230VAC		8387580000
Pluggable	OST EG7 230VAC RC		8394990000

Information

Accessories

Information	
Locking socket RS EG7	8193830000