

AVR-GSM development board

Users Manual



All boards produced by Olimex are ROHS compliant

Rev.B, January 2009
Copyright(c) 2009, OLIMEX Ltd, All rights reserved

INTRODUCTION:

AVR-GSM is excellent board for adding remote monitoring and control in remote places by GSM cellular network. Do you want to switch on/off your local heating in your mountain house? To monitor the temperature at up to 8 remote points up to 30 meters away from the module? To listen what happens in your house with silent call after you get message for alarm status? Then **AVR-GSM** is the board for you! It contains ATmega32 microcontroller and 3-band GSM GPRS module 900/1800/1900Mhz inside which covers most used GSM networks around the world. The GSM antenna is build in the board so no need for external expensive GSM antennas. **AVR-GSM** have two relays 240VAC/10A, two opto-isolated inputs which could be connected to alarm sensors or just buttons for user actions (like call pre-loaded phone numbers), on-board temperature sensor and connector for additional up to 8 addressable remote temperature sensors at up to 30 meter distance from the module. Normal phone hook can be connected to this board and to allow user to speak, listen, taking and placing phone calls as normal stand alone cellular phone. AVR-GSM can be connected to PC with the USB connector it have and it is recognized as modem which could be used to add internet via GPRS to your computer (imagine how useful is this for your mountain house if there is no internet but only cellular network!).

BOARD FEATURES:

- MCU: ATmega32 32KB Flash memory, 2KB RAM, 1KB EEPROM
- JTAG connector for programming and debugging with AVR-JTAG-L or AVR-JTAG-USB
- GSM GPRS 3-BAND MODULE 900/1800/1900Mhz with build on-board GSM cellular antenna
- Li-ion backup battery for up to 200 hours of GSM module stand-by (no relays etc - peripherals active)
- SIM-card holder
- Two RELAYS 240VAC/10A
- Two opt isolated inputs
- USB interface
- 2.5mm Hands-free connector;
- Buzzer (ringer)
- Status LED
- On-board temperature digital sensor
- Connector for remote temperature sensors up to 30meters far away from AVR-GSM
- Plastic housing (optional)
- Extension 26 pin connector for all unused ATmega32 ports
- PCB: FR-4, 1.5 mm (0,062"), solder mask, silkscreen component print
- Dimensions: 130x82x34 mm (5.1x3.2x1.3")

ELECTROSTATIC WARNING:

The AVR-GSM board is shipped in protective anti-static packaging. The board must not be subject to high electrostatic potentials. General practice for working with static sensitive devices should be applied when working with this board.

BOARD USE REQUIREMENTS:

Cables: 1.8 meter USB A-B cable to connect to USB host on PC.

Hardware: **AVR-JTAG, AVR-USB-JTAG**
Or any compatible tool for programming and/or debugging

Software: **AVRStudio + WinAVR** for developing your own applications
The demo software show basic functionality and how to place / take phone calls (C source and HEX) or how to remote control via SMS (C source and HEX)

The sources are compiled with WinAVR free C compiler.

Important: If your board does not work, first try to charge the battery as you power supply the board for few hours.

PROCESSOR FEATURES:

- High-performance, Low-power AVR® 8-bit Microcontroller
- Advanced RISC Architecture
 - 131 Powerful Instructions – Most Single-clock Cycle Execution
 - 32 x 8 General Purpose Working Registers
 - Fully Static Operation
 - Up to 16 MIPS Throughput at 16 MHz
 - On-chip 2-cycle Multiplier
- Nonvolatile Program and Data Memories
 - 32K Bytes of In-System Self-Programmable Flash Endurance: 10,000 Write/Erase Cycles
 - 1024 Bytes EEPROM Endurance: 100,000 Write/Erase Cycles
 - 2K Byte Internal SRAM
 - Programming Lock for Software Security
- JTAG (IEEE std. 1149.1 Compliant) Interface
- Peripheral Features
 - Two 8-bit Timer/Counters with Separate Prescalers and Compare Modes
 - One 16-bit Timer/Counter with Separate Prescaler, Compare Mode, and Capture Mode
 - Real Time Counter with Separate Oscillator
 - Four PWM Channels
 - 8-channel, 10-bit ADC with Programmable Gain at 1x, 10x, or 200x
 - Byte-oriented Two-wire Serial Interface
 - Programmable Serial USART
 - Master/Slave SPI Serial Interface
 - Programmable Watchdog Timer with Separate On-chip Oscillator
 - Power-on Reset and Programmable Brown-out Detection

BLOCK DIAGRAM:

Figure 2. Block Diagram

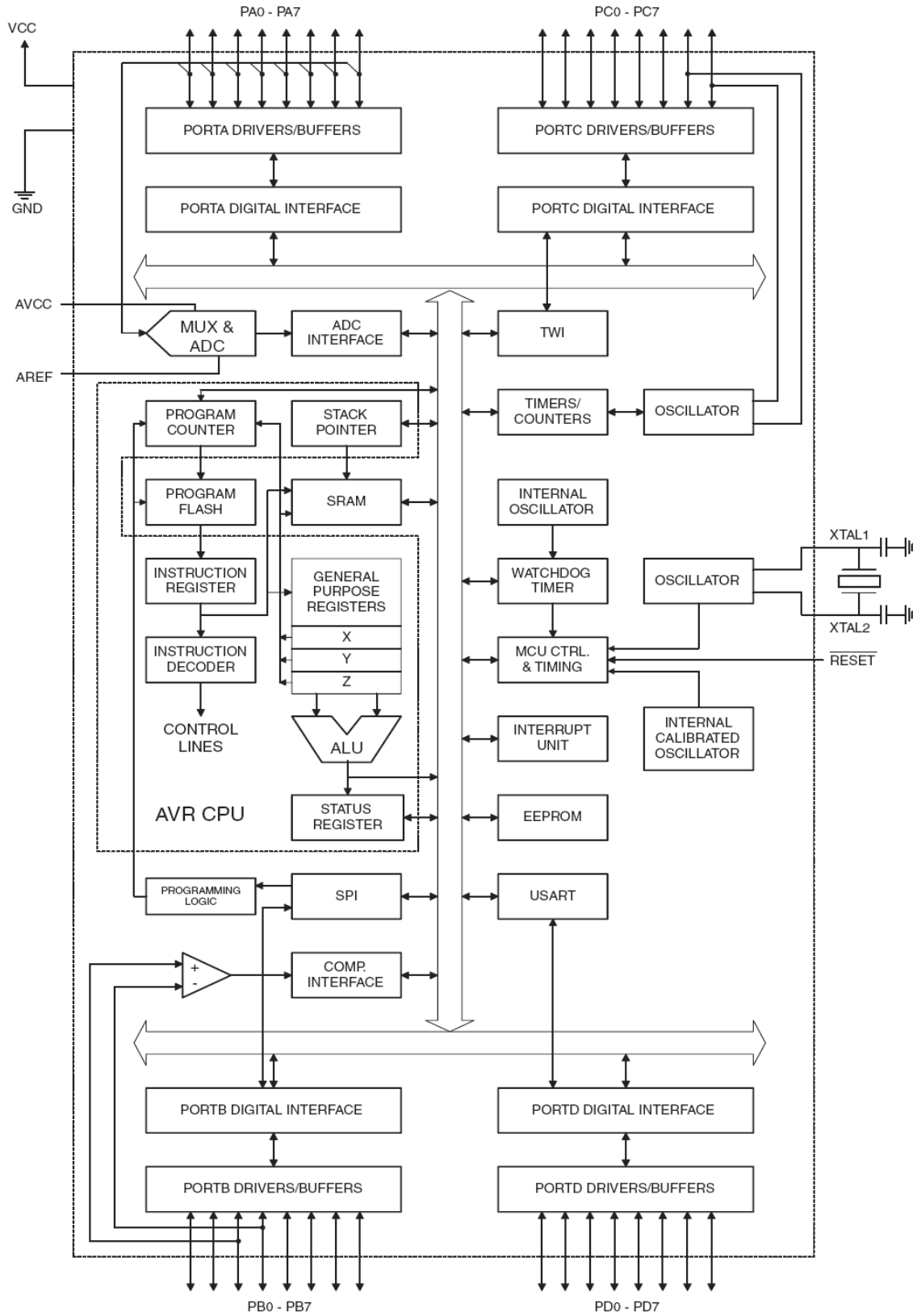

MEMORY MAP:

Program Memory Map

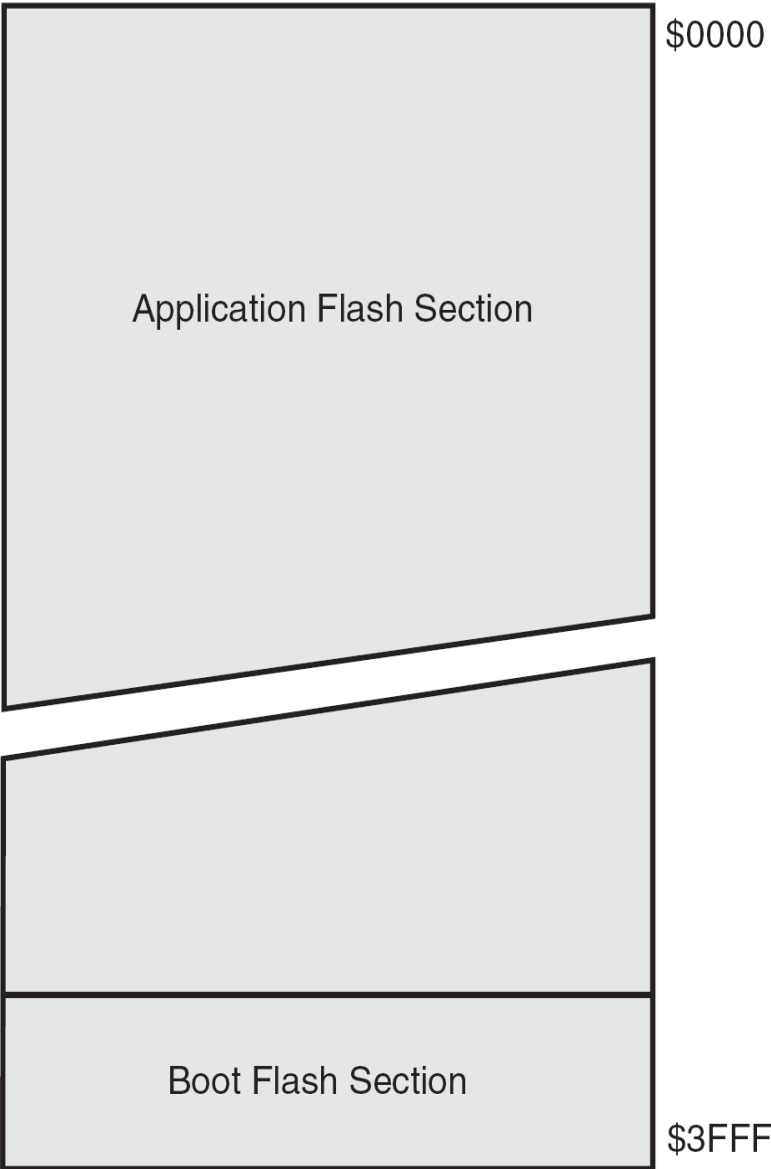

Data Memory Map

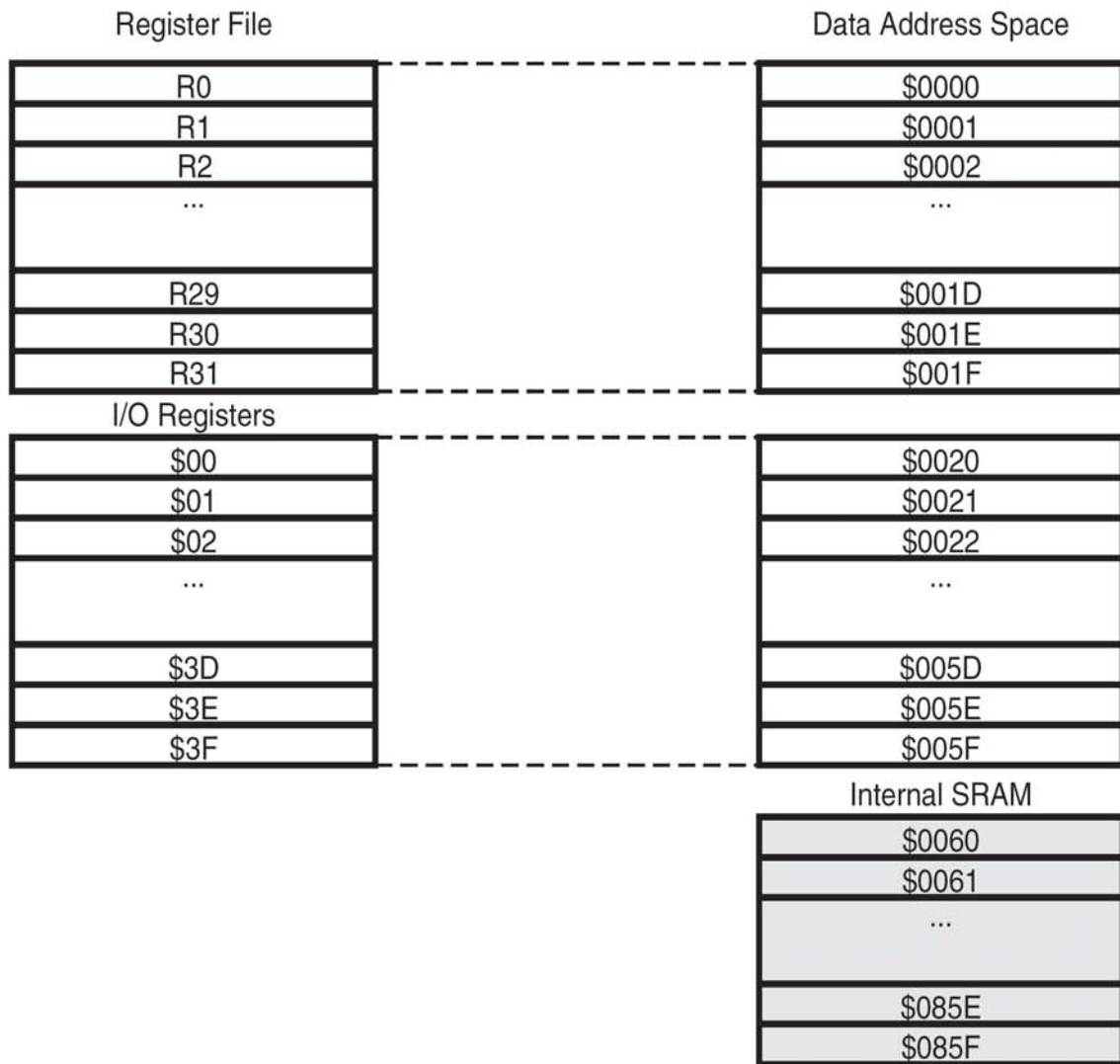

SCHEMATIC:

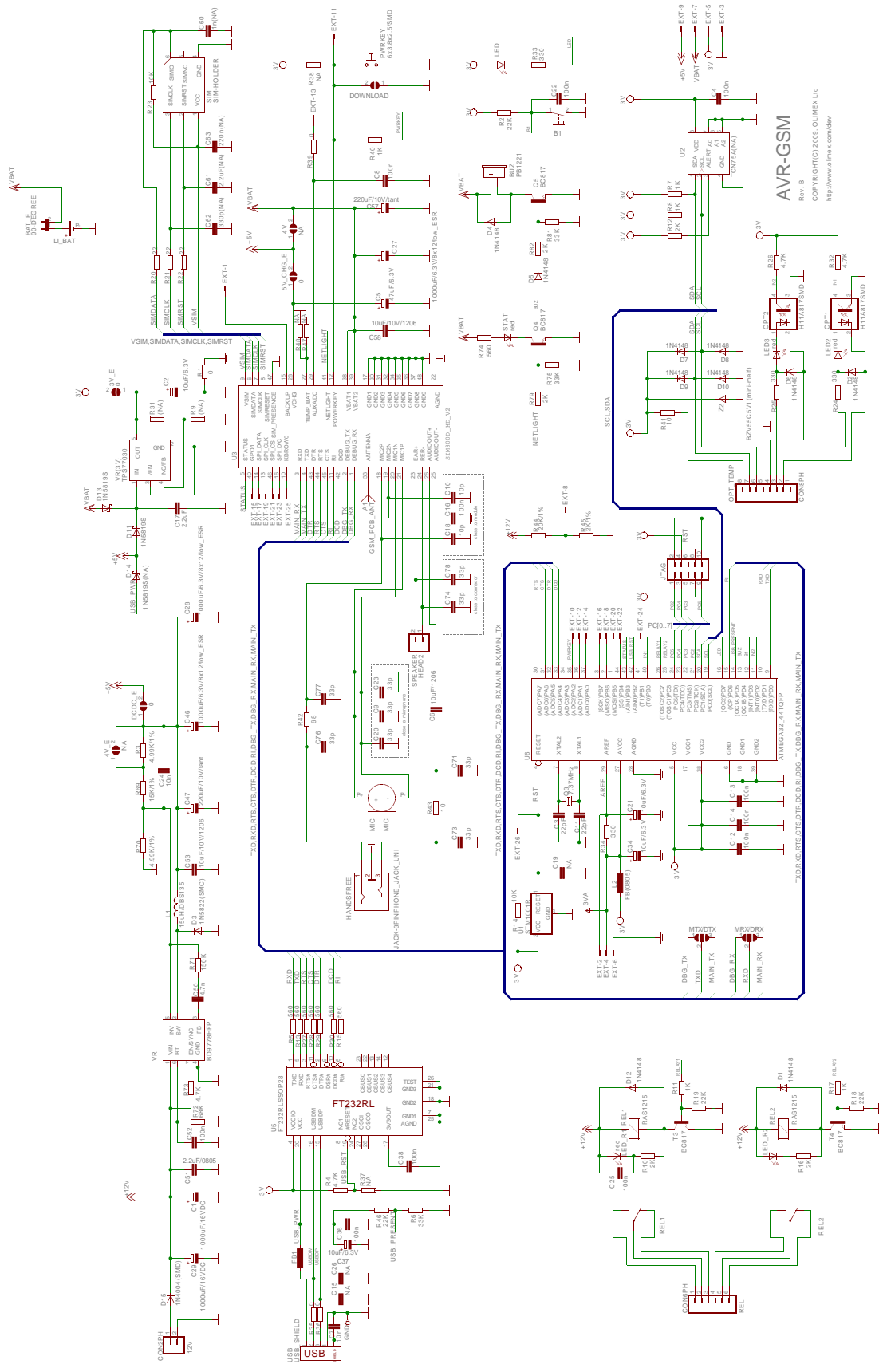

BOARD LAYOUT:

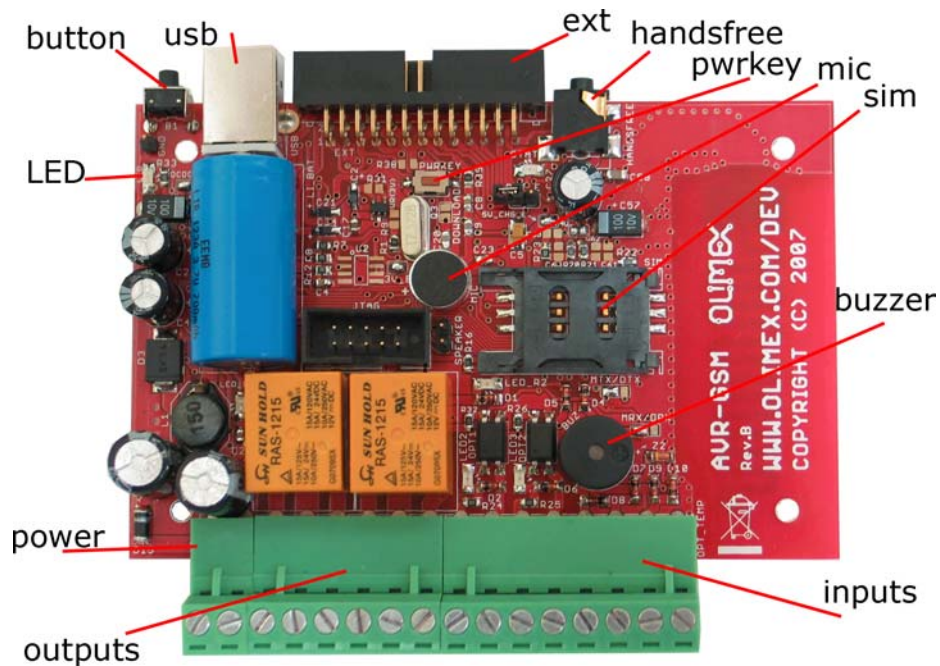

POWER SUPPLY CIRCUIT:

The power supply of AVR-GSM could be done in two different ways:

1. Power from +12VDC without using the internal backup battery. The module is powered only from external 12V and the battery is not connected. In this case:
 - jumper BAT_E must be open
 - jumper 4V_E must be closed
 - jumper 4V must be closed
 - jumper 5V_CHG_E must be open.Power consumption in this mode is:
 - about 60mA when have a conversation.
 - About 25mA in normal mode (without conversation) + 60mA if relays are turned on.

Important: 4V_E, 4V and 5V_CHG_E jumpers have to be moved together.
2. Power from +12VDC with backup battery. The module is powered with battery and allows battery charging. In this case:
 - jumper BAT_E must be closed
 - jumper 4V_E must be open
 - jumper 4V must be open

- jumper 5V_CHG_E must be closed
- Power consumption in this mode: depend on the battery charge may vary between 10 and 300mA. If the 12V power supply is missing the battery discharge current is between 5 and 25 mA without call, and about 200mA during active call.

RESET CIRCUIT:

AVR-GSM reset circuit is made with STM1001R with typical threshold +2.63V.

CLOCK CIRCUIT:

Quartz crystal 7.37MHz is connected to ATmega32.

CONNECTOR DESCRIPTIONS:

JTAG:

Pin #	Signal Name
1	PC2(TCK)
2	GND
3	PC4(TDO)
4	3V
5	PC3(TMS)
6	RST
7	3V
8	NC
9	PC5(TDI)
10	GND

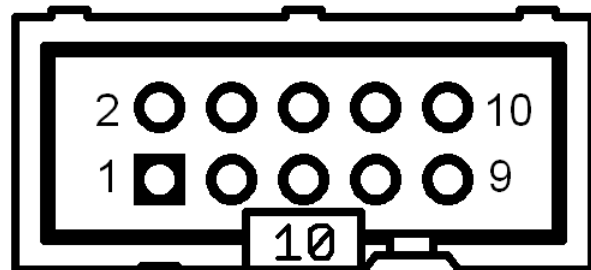

This connector allows programming and debugging via AVR-JTAG or compatible tool.

USB:

Pin #	Signal Name
1	VCC
2	USBDM
3	USBDP
4	GND



This is standard USB Type B connector for connection to PC. On board there is FT232RL USB to UART converter. To use it you should download and install the drivers for your OS from <http://www.ftdichip.com/Drivers/CDM/CDM20602.zip>. ATmega32 can control FTDI chip as detect USB present and can toggle RST line of FTDI chip, i.e. the microcontroller decides whether the communication is between PC terminal and GSM module or between ATmega32 and GSM module. When USB cable from PC is connected to AVR-GSM – ATmega32 allows communication between USB (PC terminal) and GSM module, when USB cable is removed from AVR-GSM, the communication is between ATmega32 and GSM module.

SIM-CARD:

Pin #	Signal Name
1	VSIM
2	SIMRST
3	SIMCLK
4	GND
5	NC
6	SIMDATA

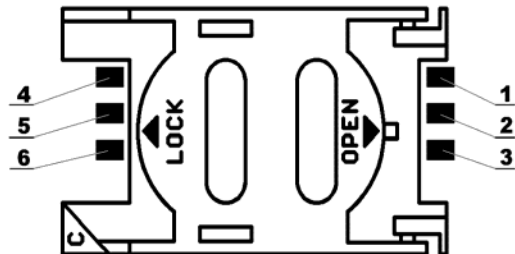

This is standard SIM card connector, to operate AVR-GSM should have inserted valid SIM card for your operator network. Note that the SIM card should be without PIN security.

PWR-CON:

Pin #	Signal Name
1	+12V
2	GND

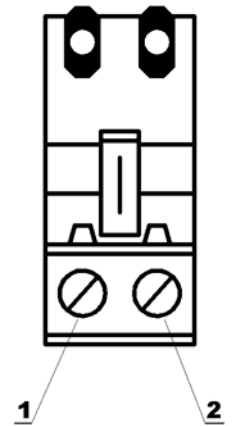

This connector is used to power the AVR-GSM. External (12VDC) power source have to be applied to this pins.

OUTPUT RELAYS CONNECTOR:

Pin #	Signal Name
1	NO-REL1
2	COMMON-REL1
3	NC-REL1
4	NO-REL2
5	COMMON-REL2
6	NC-REL2

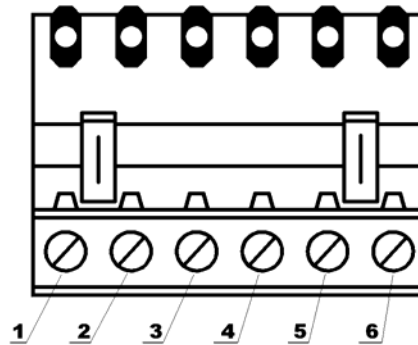

NO – relay normally opened contact, NC – relay normally closed contact
COMMON – relay common contact

By this connector the user can switch on/off load witch not exceed next maximal admissible ranges:

- 15A/125VAC
- 10A/250VAC
- 15A/24VDC

INPUT OPTOCOUPLER & TEMP CONNECTOR:

Pin #	Signal Name
1	DIGITAL IN1 +
2	DIGITAL IN1 -
3	DIGITAL IN2 +
4	DIGITAL IN2 -
5	GND
6	SCL
7	SDA
8	3V

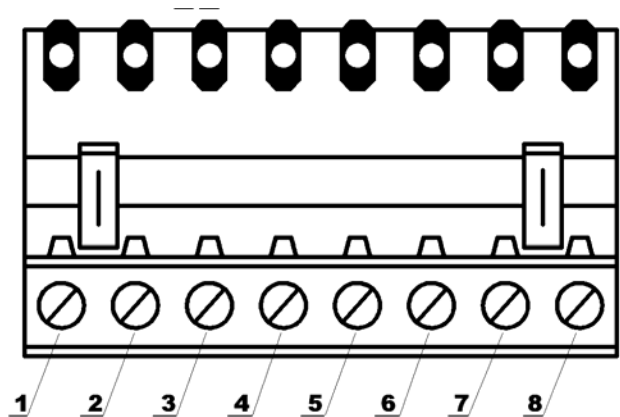

Two digital optoisolated inputs are available for user code. The input level are between 5 and 12V DC.

I2C signals (SCL, SDA) are used for external temperature sensor connection or other suitable I2C device interfacing.

There is possibility up to 8 external temperature sensors on this bus. Olimex sell these modules separately under the order code MOD-TMP and communication with up to 30 meters between the AVR-GSM and MOD-TEM is possible error free.

HANDSFREE:

Pin #	Signal Name
GND	GND
AU+	AU+ audio out
MIC	MIC2P audio in

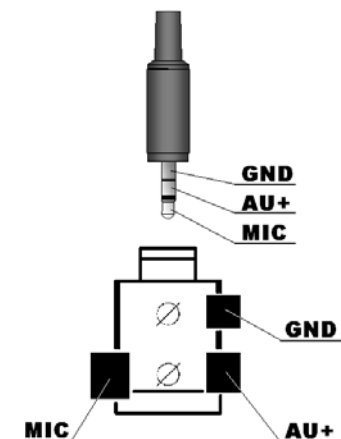

This is Audio 2.5 mm connector. Standard hands-free headphone/microphone combined cable can be used

SPEAKER CONNECTOR - SPEAKER:

Pin #	Signal Name
1	EAR-
2	EAR+

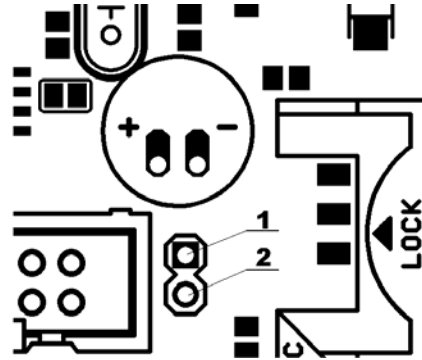

This is connector for external 32 ohm speaker

EXT:

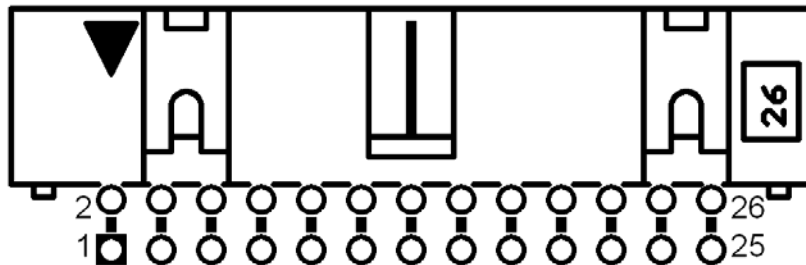

Pin #	Signal Name	Pin #	Signal Name
1	BACKUP	2	AREF
3	GND	4	3VA
5	3V	6	AGND
7	VBAT	8	(ADC3)/PA3
9	+5V	10	PWRKEY - (ADC2)/PA2
11	POWERKEY-pin12 of GSM module	12	(ADC1)/PA1
13	AUXADC	14	(ADC0)/PA0
15	GPO1	16	(SCK)PB7
17	SPI_DATA	18	(MISO)PB6
19	SPI_CLK	20	(MOSI)PB5
21	SPI_CS	22	(SS)PB4
23	SPI_D/C	24	(T1)PB1
25	KBROW0	26	RST

EXT is connector for external plug-in modules. It's standard 26 pin ribbon cable IDC keyed connector.

Backup: RTC backup power supply for the GSM module real time clock and RAM, when the battery is discharged. If the battery attached to this signal is chargeable and the voltage level is low the module will charge the battery. $V_{nom} = 1.8V$, $I_{nom} = 20\mu A$

AREF: Analog reference input of ATmega32 microcontroller. Can be used for external analogue circuits.

GND: Digital ground.

3VA: Analog power supply of ATmega32 microcontroller. This is 3VDC output which can be used for external analog modules.

3V: Digital power of ATmega32. This is 3VDC output for external digital modules.

AGND: Analog ground of ATmega32 microcontroller. Can be used for external analog circuits.

VBAT: Dedicated to connect main Li-ion battery. The power supply of GSM module has to be a single voltage source of $V_{BAT} = 3.4V \dots 4.5V$. Li-ion battery with 650mA capacity is used in AVR-GSM.

ADC3/PA3: ADC3 input/digital IO of ATmega32.

+5V: +5VDC output / up to 2A current source

POWERKEY: This is GSM module power on/off key. When the module is ON if you press and hold for more than 3 seconds the module go in power down state. If the module is in power down mode and you press and hold this key for more than 1 second the module will go in ON mode.

ADC1/PA1: ADC1 input/digital IO of ATmega32.

AUXADC: This is general purpose analog to digital converter build-in the GSM module. The input voltage value should be in range 0V to 2.4V. This pin value can be read with AT command.

ADC0/PA0: ADC0 input/digital IO of ATmega32.

GPO1: This is GPO of GSM module and can be configured by AT command for outputting high or low level voltage. All of the GPOs are initially in low state without any setting from AT command.

(SCK)PB7,(MISO)PB6,(MOSI)PB5,(SS)PB4: ATmega32 SPI pins.

SPI_DATA,SPI_CLK,SPI_CS,SPI_D/C: This is GSM module SPI port reserved for future use.

KBROW0: This is external keyboard input pin of GSM module.

RST: ATmega32 Reset pin. Open collector output.

JUMPER DESCRIPTION:

BAT_E Connects 3.7V Li-ion battery to the GSM module. Default state is to be open to not drain the battery during stocking the modules.

Default state - open



4V_E When this jumper is open state the DCDC voltage output is set to 5V, when the jumper is closed the DCDC output voltage is set to 4V. This is necessary when main battery is not connected and the supply voltage should be 4V, when the battery is connected the DCDC voltage should be 5V.

Default state – open.



4V When the main battery is not present, this jumper feeds the 4V from the DCDC output to the GSM module.

Default state – open.



5V_CHG_E The GSM module have build in li-ion charge circuit. This jumper connects the DCDC 5V output to the internal charger circuit.

Default state closed



Important: 4V_E, 4V and 5V_CHG_E jumpers have to be moved together.

Do not plug in external +12V if BAT_E jumper is open!

DCDC_E This jumper connects the DCDC output to the GSM module. It is useful to measure the current consumption.

Default state closed



3V_E This jumper connects +3V to FT232RL and ATmega32. It is useful to measure the current consumption.

Default state closed



Download This is GSM module bootloader enable pin. Reserved for GSM module firmware upgrade.

Default state – open.



MTX/DTX The GSM module have two UART channels. One for the commands, one for debugging. With this jumper you control which channel goes to ATmega32 and FT232RL.

MTX/DTX



Default state MTX

MRX/DRX The GSM module have two UART channels. One for the commands, one for debugging. With this jumper you control which channel goes to ATmega32 and FT232RL.

MRX/DRX



Default state MRX

INPUT/OUTPUT:

Button B1: user button connected to ATmega32 pin.12 PD3 (INT1);

PWRKEY button – This is GSM module power on/off key. When the module is ON if you press and hold for more than 3 seconds the module go in power down state. If the module if in power down mode and you press and hold this key for more than 1 second the module will go in ON mode.

MIC – on-board microphone (voice), with AT command you can switch the voice audio input to be taken from this microphone of from the handsfree audio connector.

SPEAKER – voice output for external 32 ohm speaker, with AT command you can switch the voice audio output to be directed to this speaker or to the handsfree audio connector.

HANDSFREE – audio 2.5 mm jack voice input and speaker output.

BUZ – audio buzzer , can be used as RING signalization.

Status green LED with name **LED** connected to ATmega32 pin.16 PD7.

Status red LED with name **STAT** – indicates the state of GSM module.

STAT is off state – GSM module is not running

64ms On/ 800ms Off – GSM module does not find the network

64ms On/ 3000ms Off – GSM module is connected to the network

64ms On/ 300ms Off - GPRS communication

Optocouple 1 – **OPT1** (H11A817SMD) - 5V-12V optoisolated input with LED2 indication and open collector output connect to ATmega32 pin.40 (PB0(T0)). Positive voltage of '+' terminal and negative voltage or GND of '-' terminal of OPT_TEMP connector, reflect with log. 0 of Mega32 input.

Optocouple 2 – **OPT2** (H11A817SMD) - 5V-12V optoisolated input with LED3 indication and open collector output connect to ATmega32 pin.11 (PD2(INT0)).Positive voltage of '+' terminal and negative voltage or GND of '-' terminal of OPT_TEMP connector, reflect with log. 0 of Mega32 input.

Relay1 – **REL1** 240VAC/10A (RAS1215) with default tied Normal Close (NC) and COM terminals and disconnected Normal Open and COM terminals.

LED_R1 (Red) indicated when turn on **REL1**. The relay is turned on with log 1 of PC7 port.

Relay1 – **REL2** 240VAC/10A (RAS1215) with default tied Normal Close (NC) and COM terminals and disconnected Normal Open and COM terminals.

LED_R2 (Red) indicated when turn on **REL2**. The relay is turned on with log 1 of PC6 port.

MECHANICAL DIMENSIONS:

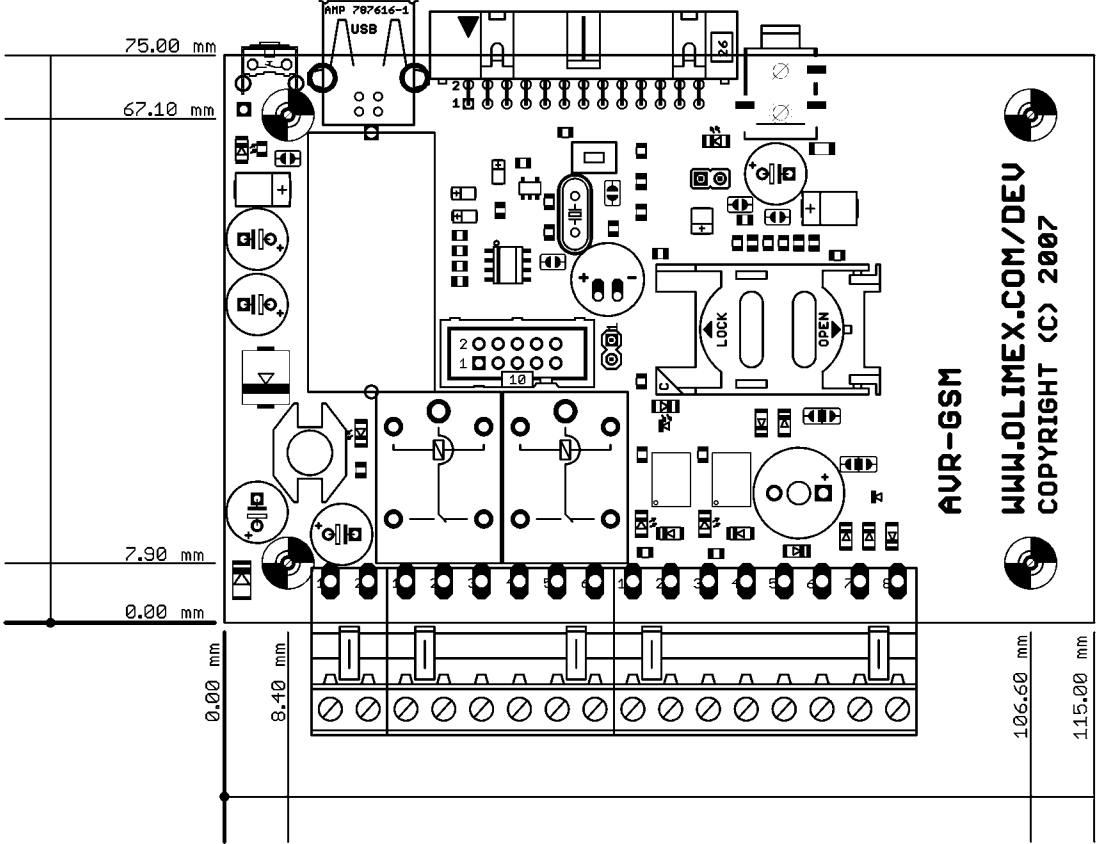

All measures are in mm.

AVAILABLE DEMO SOFTWARE:

- Placing/taking phone calls with AVR-GSM ([C source](#))
- Remote control via SMS on AVR-GSM ([C source](#)) firmware [description](#)

ORDER CODE:

How to order?

You can order to us directly or by any of our distributors.

Check our web www.olimex.com/dev for more info.



All boards produced by Olimex are ROHS compliant

Revision history:

REV.B

- create

January 2009

Disclaimer:

© 2009 Olimex Ltd. All rights reserved. Olimex®, logo and combinations thereof, are registered trademarks of Olimex Ltd. Other terms and product names may be trademarks of others.

The information in this document is provided in connection with Olimex products. No license, express or implied or otherwise, to any intellectual property right is granted by this document or in connection with the sale of Olimex products.

Neither the whole nor any part of the information contained in or the product described in this document may be adapted or reproduced in any material from except with the prior written permission of the copyright holder.

The product described in this document is subject to continuous development and improvements. All particulars of the product and its use contained in this document are given by OLIMEX in good faith. However all warranties implied or expressed including but not limited to implied warranties of merchantability or fitness for purpose are excluded. This document is intended only to assist the reader in the use of the product. OLIMEX Ltd. shall not be liable for any loss or damage arising from the use of any information in this document or any error or omission in such information or any incorrect use of the product.