

ASSEMBLY PART NUMBER	COLOR	KEYING OPTION	DIMENSIONS		CAVITY TYPE & STATUS (X = PLUGGED)									
			A	B	1	2	3	4	5	6	7	8		
33482-0801	BLACK	A	60	60										
33482-0802	LT.GRAY	B	25	60										
33482-0803	BROWN	C	60	25										
33482-0804	GREEN	D	25	25										
33482-0805	CUSTOM	TBD												
33482-0806	BLACK	A	60	60						X				
33482-0807	LT.GRAY	B	25	60						X				
33482-0808	BROWN	C	60	25						X				
33482-0809	GREEN	D	25	25						X				
33482-0810	CUSTOM	TBD								X				
33482-0811	BLACK	A	60	60						X	X			
33482-0812	LT.GRAY	B	25	60						X	X			
33482-0813	BROWN	C	60	25						X	X			
33482-0814	GREEN	D	25	25						X	X			
33482-0815	CUSTOM	TBD								X	X			
33482-0816	BLACK	A	60	60	X					X	X			
33482-0817	LT.GRAY	B	25	60	X					X	X			
33482-0818	BROWN	C	60	25	X					X	X			
33482-0819	GREEN	D	25	25	X					X	X			
33482-0820	CUSTOM	TBD			X					X	X			
33482-0821	BLACK	A	60	60	X					X	X			X
33482-0822	LT.GRAY	B	25	60	X					X	X			X
33482-0823	BROWN	C	60	25	X					X	X			X
33482-0824	GREEN	D	25	25	X					X	X			X
33482-0825	CUSTOM	TBD			X					X	X			X
33482-0826	BLACK	A	60	60	X	X	X					X	X	X
33482-0827	BLACK	A	60	60										X
33482-0828	BLACK	A	60	60			X			X				
33482-0829	BLACK	A	60	60		X	X	X	X	X	X			
33482-0830	BLACK	A	60	60								X		
33482-0831	BLACK	A	60	60			X			X	X			
33482-0832	BLACK	A	60	60						X	X			X
33482-0833	BLACK	A	60	60	X		X	X	X	X	X	X	X	X
33482-0834	BLACK	A	60	60	X	X	X	X	X	X	X	X	X	X
33482-0835	BLACK	A	60	60								X	X	X
33482-0836	BLACK	A	60	60		X	X					X	X	X
33482-0837	BLACK	A	60	60	X			X						X
33482-0838	BLACK	A	60	60		X	X			X	X	X	X	X
33482-0839	LT.GRAY	B	25	60										X
33482-0840	BLACK	A	60	60		X	X			X	X	X	X	X
33482-0841	BLACK	A	60	60								X	X	X
33482-0842	BLACK	A	60	60										X

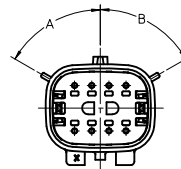

KEYING OPTION
SEE TABLE
SCALE 2:1

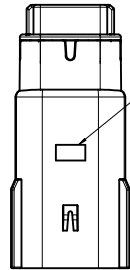

OPTIONAL TRACEABILITY
INFORMATION LOCATED IN
THIS AREA

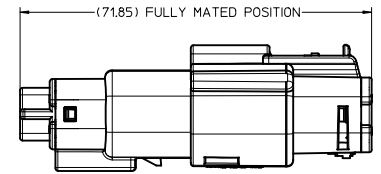

SCALE 1:1

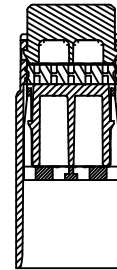

SECTION A-A

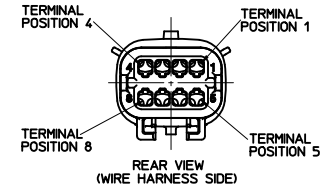

REAR VIEW
(WIRE HARNESS SIDE)

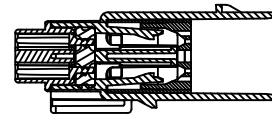

SECTION B-B
(BLADE SHOWN IN FULL-LOCK POSITION)
SEE NOTE 2

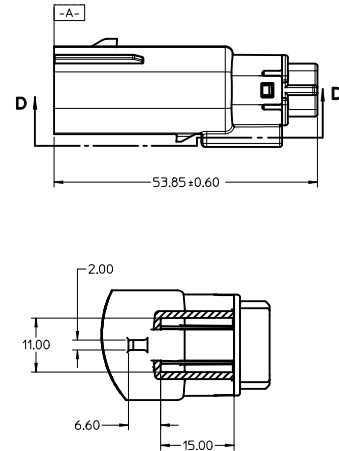
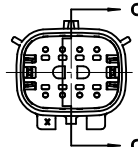
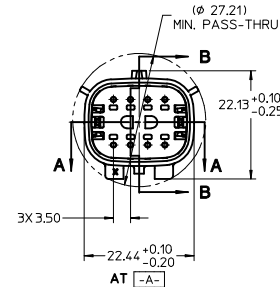

SECTION D-D

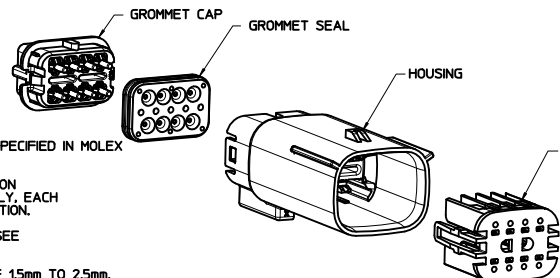

NOTES: UNLESS OTHERWISE SPECIFIED

- DESIGNED TO MATE WITH RECEPTACLE HOUSING ASSEMBLY SPECIFIED IN MOLEX CHARTED DRAWING SD-33472-081.
- ASSEMBLY SHIPPED WITH BLADE INSERT IN PRE-LOCK POSITION (SEE SECTION C-C PRE-LOCK). UPON FULL TERMINAL ASSEMBLY, EACH BLADE INSERT MUST BE SNAPPED INTO ITS FINAL-LOCK POSITION.
- FOR BLADE TERMINALS TO BE USED WITH THIS ASSEMBLY, SEE DRAWING SD-33000-001.
- SYSTEM TO BE USED WITH WIRE WITHIN DIAMETER RANGE OF 1.5mm TO 2.5mm.
- MATERIAL: SPS/NYLON BLEND, 20% GLASS FILLED.
- CHENGDU ASSEMBLIES SHALL CONFORM TO PACKAGING SPECIFICATION PK-31300-635
- SHALL CONFORM TO PRODUCT SPECIFICATION PS-33472-000.
- ASSEMBLY CONFORMS TO SAE/USCAR-2 REV 4 WITH THE FOLLOWING EXCEPTIONS:
TERMINAL INSERTION FORCE FOR WIRE SIZE ABOVE 2.5mm NOT EXCEEDING 2.69mm SHALL NOT EXCEED 45 NEWTONS.

ENTER DESCRIPTION IEC NO: UAU2012-0639 DRAWN BY: DRWNCMA CHKD: APPR: VKOSHY 2011/12/05 2011/12/12	QUALITY SYMBOLS ∇=0 ∇=0 ∇=0	GENERAL TOLERANCES (UNLESS SPECIFIED) mm INCH		DIMENSION STYLE MM ONLY	SCALE 2:1	DESIGN UNITS METRIC	THIRD ANGLE PROJECTION
		4 PLACES ±--- ±--- 3 PLACES ±--- ±--- 2 PLACES ±0.10 ±--- 1 PLACE ±0.3 ±--- ANGULAR ± 3°	DRAWN BY: DMARCOUX DATE: 06-17-02 CHECKED BY: DGRIFITHS DATE: 06-17-02 APPROVED BY: VKOSHY DATE: 2010/10/27	TITLE MX150 BLADE CONNECTOR ASSEMBLY 2 ROW SEALED, 8 WAY		MOLEX INCORPORATED	
DRAFT WHERE APPLICABLE MUST REMAIN WITHIN DIMENSIONS		THIS DRAWING CONTAINS INFORMATION THAT IS PROPRIETARY TO MOLEX INCORPORATED AND SHOULD NOT BE USED WITHOUT WRITTEN PERMISSION		SHEET NO. 1 OF 2			

20 19 18 17 16 15 14 13 12 11 10 9 8 7 6 5 4 3 2 1

ASSEMBLY PART NUMBER	COLOR	KEYING OPTION	DIMENSIONS		CAVITY TYPE & STATUS (X = PLUGGED)								
			A	B	1	2	3	4	5	6	7	8	
33482-0843	BLACK	A	60	60				X				X	
33482-0844	BLACK	A	60	60			X					X	
33482-0845	BLACK	A	60	60		X	X	X	X	X	X		
33482-0846	BLACK	A	60	60					X	X		X	X
33482-0847	LT.GRAY	B	25	60	X	X	X	X	X	X	X	X	X

ENTER DESCRIPTION IEC NO: UAU2012-0639 DRAWN BY: CHYD APPR: VKOSHY 2011/12/05 2011/12/12	QUALITY SYMBOLS	GENERAL TOLERANCES (UNLESS SPECIFIED)	DIMENSION STYLE	SCALE	DESIGN UNITS	THIRD ANGLE PROJECTION
	▽=0	4 PLACES ± 0.10	MM ONLY	2:1	METRIC	☉
	▽=0	3 PLACES ± 0.10				
	▽=0	2 PLACES ± 0.10				
		1 PLACE ± 0.3				
		ANGULAR ± 3°				
	DRAFT WHERE APPLICABLE MUST REMAIN WITHIN DIMENSIONS		DRAWN BY: DMARCOUX	DATE: 06-17-02	TITLE: MX150 BLADE CONNECTOR ASSEMBLY 2 ROW SEALED, 8 WAY	
			CHECKED BY: DGRIFITHS	DATE: 06-17-02	MOLEX INCORPORATED	
			APPROVED BY: VKOSHY	DATE: 2010/10/27	DOCUMENT NO: SD-33482-081	
			MATERIAL NO: SEE TABLE	SIZE: D	SHEET NO: 2 OF 2	
			THIS DRAWING CONTAINS INFORMATION THAT IS PROPRIETARY TO MOLEX INCORPORATED AND SHOULD NOT BE USED WITHOUT WRITTEN PERMISSION			

19 18 17 16 15 14 13 12 11 10 9 8 7 6 5 4 3 2 1