

IEC Appliance Inlet C14 with Fuseholder 1- or 2-pole, Line Switch 1- or 2-pole and Voltage Selector

Medical fuse drawer

**Description**

- Panel Mount:  
Screw-on version from front or rear side, snap-in version from front side
- 4 Functions:  
Appliance Inlet, Protection class I Line Switch, 1- or 2-pole Fuseholder with interchangeable fuse drawer for Fuse-links 5 x 20 mm or 6.3 x 32 mm, Voltage Selectors
- Quick connect terminals 4.8 x 0.8 mm
- Alternative: version with line filter [CG](#)

**Approvals**

- VDE License Number: 40030343
- UL License Number: E93617
- CSA License Number: 38456

**Characteristics**

- All single elements are already partially wired
- For added safety "Extra-Safe" fuse drawers are available  
Fuse drawer meets requirements of medical standard IEC/EN 60601-1  
The fuse drawer can only be opened with the aid of a tool  
The fuseholder is accessible from the equipment front
- Qualified for use in equipment according IEC/EN 60950

**Other versions on request**

- Line switch, illuminated
- Line switch with other rocker marking
- Line switch 1-pole
- For protection class II

**References**[General Product Information](#)**Weblinks**[Approvals](#), [RoHS](#), [CHINA-RoHS](#), [Mating Connectors](#), [Distributor-Stock-Check](#), [Accessories](#)**Technical Data**

Ratings IEC	10A / 250VAC; 50Hz	Appliance Inlet	C14 acc. to IEC/EN 60320-1, UL 498, CSA C22.2 no. 42 (for cold conditions) pin-temperature 70 °C, 10A, Protection Class 1
Ratings UL/CSA	10A / 125VAC; 60Hz	Fuseholder	1 or 2 pole, Shocksafe category PC2 acc. to IEC 60127-6, for fuse-links 5 x 20 or 6.3 x 32 mm
Dielectric Strength	> 3kVAC between L-N > 4kVAC between L/N-PE (1 min/50Hz)	Rated Power Acceptance @ Ta 23 °C	5 x 20: 2.5W (1 pole)/ 2W (2-pole) per pole 6.3 x 32: 3.15W (1 pole)/ 2.5W (2-pole) per pole
Allowable Operation Temp.	-25 °C to 70 °C	Power Acceptance @ Ta > 23 °C	Admissible power acceptance at higher ambient temperature see derating curves
Degree of Protection	from front side IP 40 acc. to IEC 60529	Line Switch	Rocker switch 2-pole, non-illuminated, acc. to IEC 61058-1 <a href="#">Technical details</a>
Protection Class	Suitable for appliances with protection class 1 acc. to IEC 61140	Voltage Selectors	series-parallel, 4, 3 or 2 switch positions or usable as 2-pole change-over switch
Terminal	Quick connect terminals 4.8 x 0.8 mm		
Panel Thickness s	Screw: max 8 mm Mounting screw torque max 0.5Nm Snap-in: 1.5/2/2.5 mm		
Material: Housing	Thermoplastic, black, UL 94V-0		

**Dimensions**

Screw on PCB mounting

Snap-in mounting

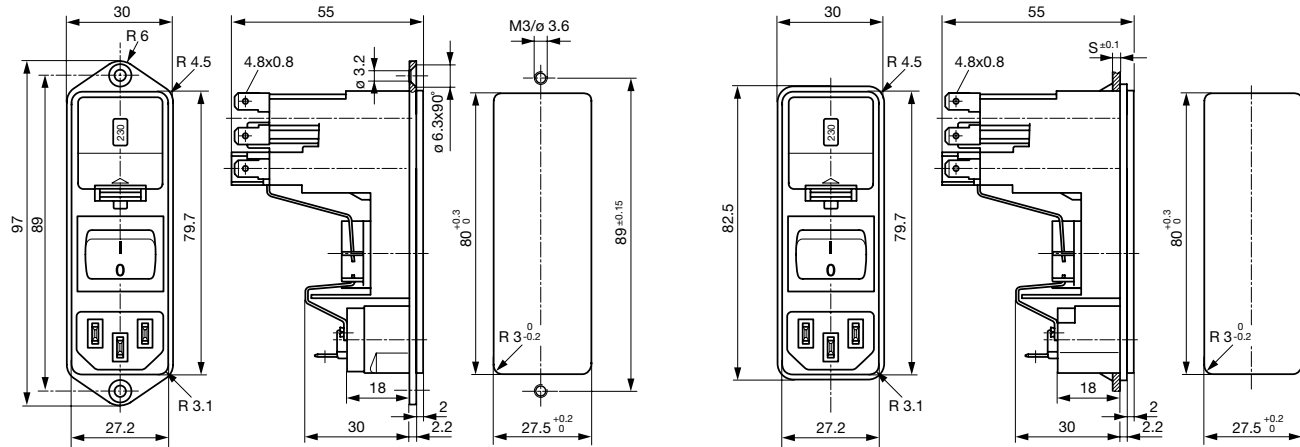

**Diagrams**

with partial wired

with partial wired

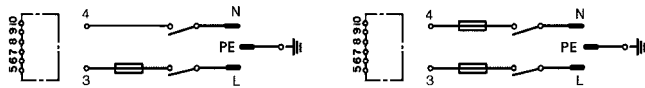

1-pole

2-pole

**Derating Curves**

Fuses  
5 x 20 mm (1-pole)

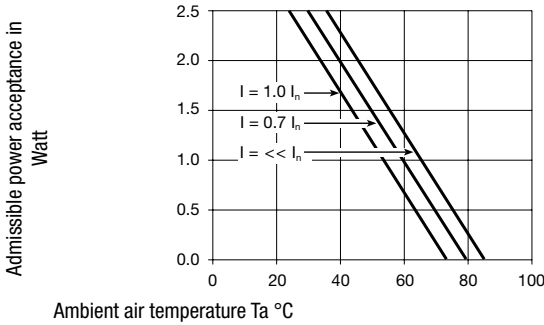

Fuses  
5 x 20 mm (2-pole, per pole)

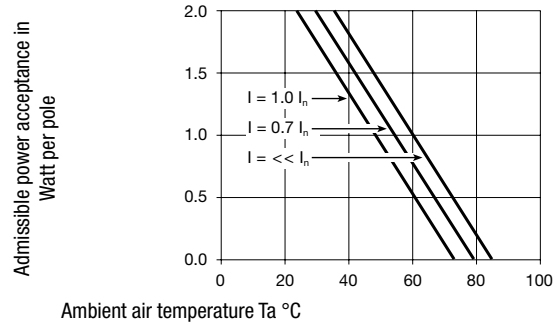

Fuses  
6.3 x 32 mm (1-pole)

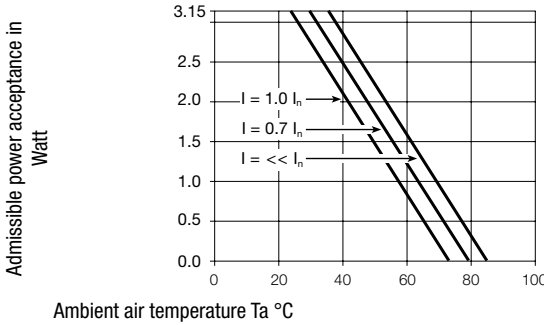

Fuses  
6.3 x 32 mm (2-pole, per pole)

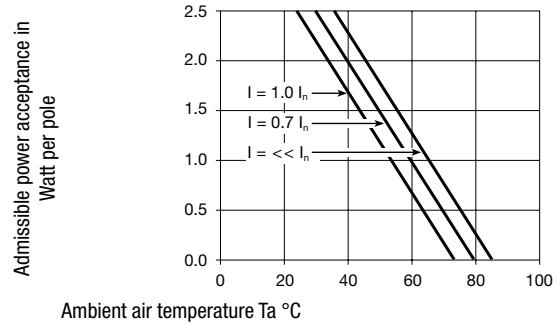

## Variants

partial wired

Fuse drawer and voltage selector insert must be ordered separately

Type	Panel mounting	Panel Thickness s [mm]	Fuseholder	Line Switch	Order Number
KG	Screw	-	1-pole	Rocker switch	KG16.5101.151
KG	Screw	-	2-pole	Rocker switch	KG10.6101.151
KG	Snap-in	1.5	1-pole	Rocker switch	KG16.5101.105
KG	Snap-in	2	1-pole	Rocker switch	KG16.5101.107
KG	Snap-in	2.5	1-pole	Rocker switch	KG16.5101.109
KG	Snap-in	1.5	2-pole	Rocker switch	KG10.6101.105
KG	Snap-in	2	2-pole	Rocker switch	KG10.6101.107
KG	Snap-in	2.5	2-pole	Rocker switch	KG10.6101.109

**Packaging unit** 20 Pcs

## Required Accessory

### Description



**Jumper Wire 1**  
Connection with Stranded Cable

Type B, 100	0881.0074
Type B, 100	0881.0075
Type A, 100	0881.0076
Type A, 100	0881.0077



**Fusedrawer 1**  
Fusedrawer for Fuse Links 5x20mm resp.. 6.3x32mm

5 x 20, 2-pole	4305.0001
5 x 20, 1-pole	4305.0006
6.3 x 32, 2-pole	4305.0011
6.3 x 32, 1-pole	4305.0016

...



**Voltage Selectors Insert 1**  
Voltage Selector Insert to KE, CE, KG, CG

3 or 4 switch positions	4305.0048.00
1, 3 or 4 switch positions, 100, 120, 220, 240	4305.0048.01
3, 3 or 4 switch positions, 130, 110, 240, 220	4305.0048.02
2, 2 switch positions, 110, 220	4305.0048.03

...

## Accessories

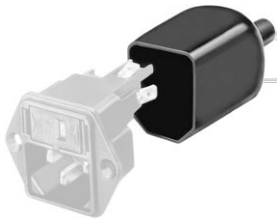

Assorted Covers  
Rear Cover

0859.0109



Cord retaining kits  
Cord retaining strain relief

Flat head, A

4700.0001

## Mating Outlets/Connectors

### Category / Description

#### Appliance Outlet Overview complete



IEC Appliance Outlet F, Screw-on Mounting, Front Side, Solder Terminal	4787
IEC Appliance Outlet F, Snap-in Mounting, Front Side, Solder or Quick-connect Terminal	4788
IEC Appliance Outlet F or H, Screw-on Mounting, Front Side, Solder, PCB or Quick-connect Terminal	5091
IEC Appliance Outlet F or H, Screw-on Mounting, Front Side, Solder or Quick-connect Terminal	5092

#### Appliance Outlet further types to KG

#### Connector Overview complete



IEC Connector C15, Rewireable, Straight	0101
IEC Connector C15A, Rewireable, Straight	0102
IEC Connector C15A, Rewireable, Straight	0102-G
IEC Connector C15A, Rewireable, Angled	0112
IEC Connector C13, Rewireable, Angled	4012

#### Connector further types to KG

...

#### Power Cord Overview complete



Power Cord with IEC Connector C13, Angled	0311
Power Cord with IEC Connector C13, Angled	3011
Power Cord with IEC Connector C13, Angled	3012
Power Cord with IEC Connector C13, Angled	3013
Power Cord with IEC Connector C13	3020

#### Power Cord further types to KG

...