

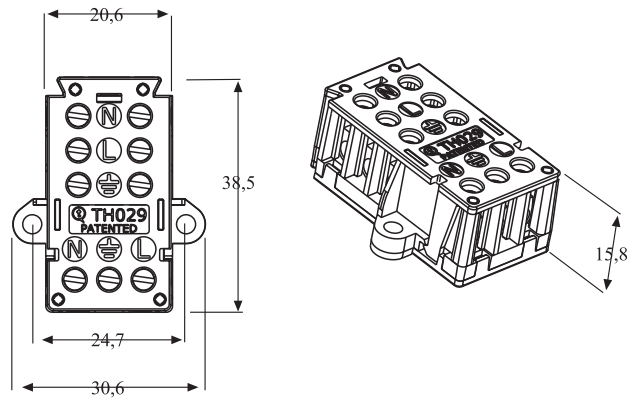

TH029

PATENTED

2+2
3+3
Poli



Capacità di connessione fino a 6[□]
Connection capability up to 6[□]

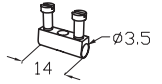

Morsettiera ripartitore di corrente a T con bussola in ottone nichelato 2+2, 3+3 poli con viti imperdibili M3 in acciaio zincato passivato.

2+2, 3+3 pole T shape terminal block current dispatcher with nickled brass bush and M3 captive screws in zinc plated steel.

Dati tecnici - Technical data

4 [□]	32 A	450V~	PTI175
T125°C			

Codice - Part number

T H B . 0 2 9 . A X A

3 poli
poles



THB.029.A1A



Materie prime - Raw materials

Materia plastica - Plastics

PA66 UL94 FV VO GWT 960°C

Marrone - Brown

-20°C

+125°C

Bussole- Insert

M3



Acciaio zincato passivato
Zinc plated steel



Ottone nichelato
Nickel plated brass

2 poli
poles



THB.029.A2A

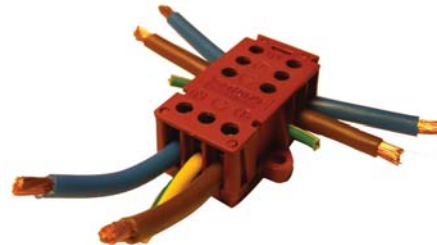

Norme - Standards

EN 60998-1:2004
EN 60998-2-1:2004



Kit di fornitura non assemblato THB
Unassembled kit THB

Kit di fornitura con versionamenti e confezionamenti speciali THK
Special custom packed version THK

THB.029.AXA

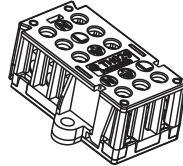
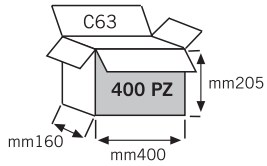

400 PZ

THK.029.XXX

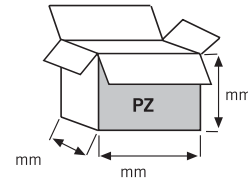

Kit di fornitura imbustati THR
Fare riferimento a catalogo THR
Retail packed kit THR
Please refer to THR Retail Catalogue

THR.029.SXX

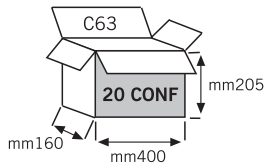

1 CONF
5 PZ



TH200



TH211

