

ETA® Magnetic and Hydraulic-Magnetic Circuit Breaker 8340-F...

Description

Single and multipole magnetic circuit breakers with trip-free, snap-action mechanism and toggle actuation. A choice of fast magnetic only or hydraulically delayed switching characteristics (S-type MO or HM CBE to EN 60934) ensures suitability for a wide range of applications. Industry standard dimensions and panel mounting. Options include auxiliary changeover contacts, or relay trip function. Low temperature sensitivity at rated load. Approved to CBE standard EN 60934 (IEC 934).

Typical applications

Control equipment, communications systems, transportation, power supplies.

Standard current ratings and typical internal resistance values

Current rating (A)	Curves and internal resistance per pole (Ω)			
	F1	F2	K1, M1, T1,	K2, M2, T2
0.02	1498	957	2669	2457
0.05	276	152	452	376
0.1	58	37	100	94
0.25	8.2	6.0	15.5	14.7
0.5	2.3	1.47	3.9	3.2
0.75	0.98	0.63	1.65	1.56
1	0.58	0.35	0.95	0.90
2	0.145	0.096	0.26	0.20
2.5	0.096	0.061	0.15	0.15
3	0.065	0.048	0.10	0.10
5	0.025	< 0.02	0.042	0.040
6	< 0.02	< 0.02	0.029	0.028
8	< 0.02	< 0.02	< 0.02	< 0.02
10	< 0.02	< 0.02	< 0.02	< 0.02
12	< 0.02	< 0.02	< 0.02	< 0.02
15	< 0.02	< 0.02	< 0.02	< 0.02
16	< 0.02	< 0.02	< 0.02	< 0.02
20	< 0.02	< 0.02	< 0.02	< 0.02
25	< 0.02	< 0.02	< 0.02	< 0.02
30	< 0.02	< 0.02	< 0.02	< 0.02
40	< 0.02	< 0.02	< 0.02	< 0.02
50	< 0.02	< 0.02	< 0.02	< 0.02

Approvals

Authority	Voltage ratings	Current ratings
VDE (EN 60934)	3 AC 415 V, AC 240 V, DC 80 V DC 80 V	0.02...30 A 0.02...50 A 1 pole
UL, CSA	3 AC 250 V, AC 250 V, DC 65 V	0.02...30 A
BV	AC 250 V, DC 65 V	0.1 ...30 A
QPL (Sweden)	AC 240 V, DC 50 V	1 ...30 A

Shock directions / Mounting attitudes

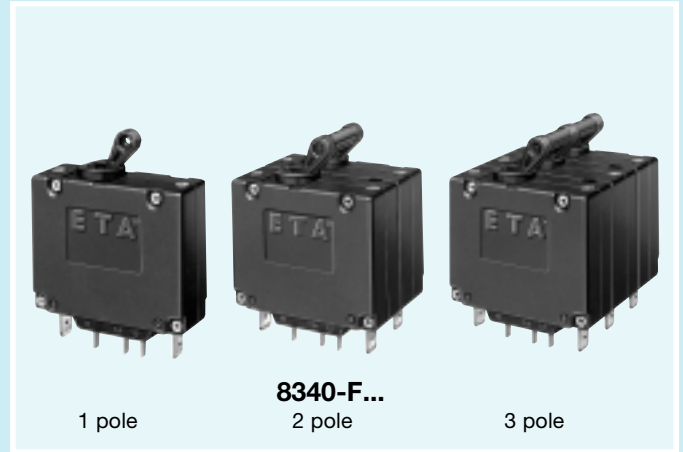
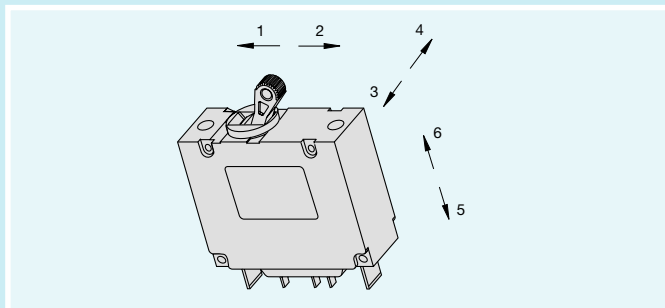

Technical data

Voltage rating	3 AC 415 V; AC 240 V, 50/60 Hz; DC 80V (higher DC ratings to special order)	
Current ratings	0.02...50 A 1 pole (40 + 50 A DC only) 0.02...30 A multi pole	
Auxiliary circuit	6 A, AC 240 V/DC 28 V 1 A, DC 65 V; 0.5 A, DC 80 V	
Typical life	10,000 operations at 1xI _N 1 pole: 40+50 A 3,000 operations at 1xI _N	
Ambient temperature	-40...+85 °C	
Insulation co-ordination (IEC 664 and 664A)	Rated impulse withstand voltage 2.5 kV	Pollution degree 2 reinforced insulation in operating area
Dielectric strength (IEC 664 and 664A) operating area	Test voltage AC 3,000 V	
pole to pole (2 and 3 pole)	AC 1,500 V	
main to auxiliary circuit	AC 3,000 V	
switching to trip circuit	AC 1,500 V (version -X)	
Insulation resistance	> 100 M Ω (DC 500 V)	
Interrupting capacity I _{cn}	1,200 A at AC – 2,000 A at DC	
Interrupting capacity (UL 1077)	I _N	0.02...20 A 25...30 A
1 pole	AC 250 V/3,500A	AC 250 V/3,500A
2 pole	AC 250 V/3,500A	AC 250 V/5,000A
3 pole	3AC 250V/3,500A	3AC250V/5,000A
1 to 3 pole	DC 65 V/2,000 A	DC 65 V/2,000 A
1 pole	DC 80 V/2,000 A	DC 80 V/2,000 A
Degree of protection (IEC 529/DIN 40050)	operating area IP 40 terminal area IP 00	
Vibration	with toggle down: 10 g (57-2000Hz) \pm 0.76mm (10-57 Hz) at 0.9xI _N Directions 1, 2, 3, 4, 5: 10 g (57-2000 Hz) at 1xI _N . With curves F1, F2 in all planes: 10 g (57-2000 Hz) \pm 0.76mm (10-57 Hz) at 0.8xI _N , to IEC 68-2-6, test Fc 10 frequency cycles/axis	
Shock	100 g (11 ms) at 1xI _N , directions 1,2,3,4,5 100 g (11 ms) at 0.8xI _N , direction 6. With curves F1, F2: 100 g (11 ms) at 0.8xI _N to IEC 68-2-27, test Ea	
Corrosion	96 hours at 5 % salt mist, to IEC 68-2-11, test Ka	
Humidity	240 hours at 95 % RH, to IEC 68-2-3, test Ca	
Mass	approx. 65 g per pole	

Please enquire for packaging quantities.

Ordering information

Ordering information

Type No.	8340 magnetic circuit breaker with toggle actuator
Mounting	F flange mounting
Configuration	1 with mounting nuts 6-32 UNC 4 with mounting nuts M3 9 snap-in frame
Number of poles	0 single pole, switch only 1 single pole protected 2 two pole protected 3 three pole protected 4 four pole protected 5 two pole, protected on one pole only 6 four pole, protected on poles 1, 2 and 3 only 7 two pole, switch only
Panel hardware	0 without panel hardware
Terminal design (main contact)	K2 screw terminals with metric thread, (recommended for $I_N \geq 20$ A) P1 blade terminals X1 blade terminals with separate switching and relay circuit
Characteristic curves	Characteristic curve F, instantaneous trip: F1 DC trip at $1.01-1.5 \times I_N$ F2 AC 50/60 Hz trip at $1.01-1.5 \times I_N$ Characteristic curve K, short delay: K1 DC trip time at $2 \times I_N$: 0.16-1.2 s K2 AC 50/60 Hz trip time at $2 \times I_N$: 0.13-1.6 s Characteristic curve M, medium delay: M1 DC trip time at $2 \times I_N$: 0.6-7.5 s M2 AC 50/60 Hz trip time at $2 \times I_N$: 2.2-20 s Without characteristic curve: Q0 switch only Characteristic curve T, long delay: T1 DC trip time at $2 \times I_N$: 10-70 s T2 AC 50/60 Hz trip time at $2 \times I_N$: 15-150 s
Relay trip X:	X1 voltage trip at DC, instantaneous trip X2 voltage trip at AC, instantaneous trip Other curves to special order (e.g. pulse delayed, high inrush currents, capacitive loads)
Actuator colour / design	A black, long toggle B white, long toggle short or coloured toggles to special order
Actuator marking	0 without marking 2 ON-OFF 3 I-O 5 I-O side marking
Auxiliary contacts	H0 without auxiliary contacts H1 with auxiliary contacts H2 auxiliary contacts on one pole only (multi pole) H3 auxiliary contacts on poles 1 and 3 (3 and 4 pole) G1 as H1, but contacts gold plated G2 as H2, but contacts gold plated G3 as H3, but contacts gold plated
Auxiliary contact function	4 1 change over contact
Auxiliary contact terminal design	2 blade terminal 2.8-0.5 mm
Current ratings	0.02...30 A
Voltage rating – curves X1, X2	DC 5 V, 8 V, 12 V, 24 V AC 110 V, 220 V, 240 V

8340 - F 1 1 0 - P1 M1 - A 0 H1 4 2 - 10 A | ordering example

Internal connection diagrams

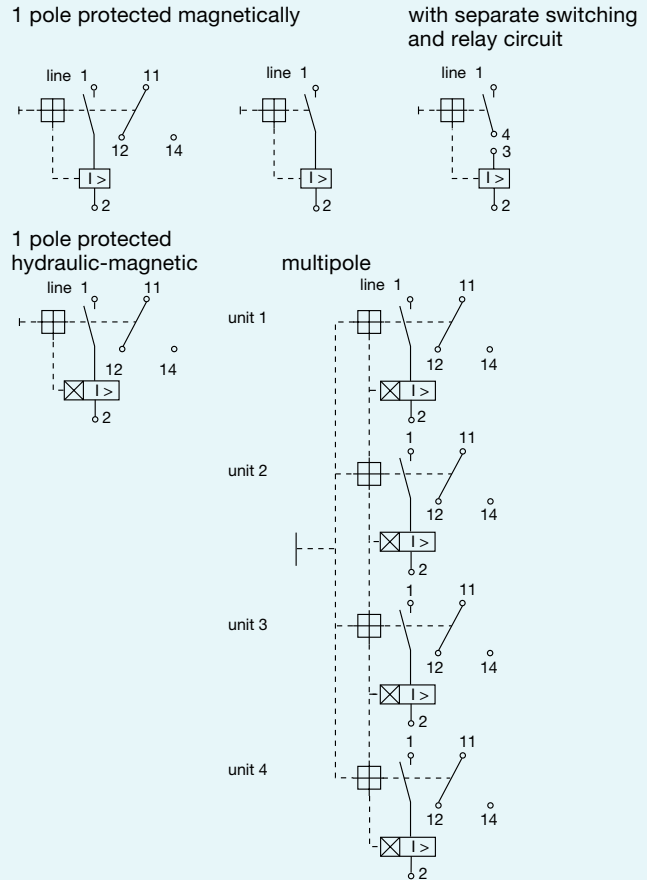

Dimensions

Mounting configuration 8340-F9..

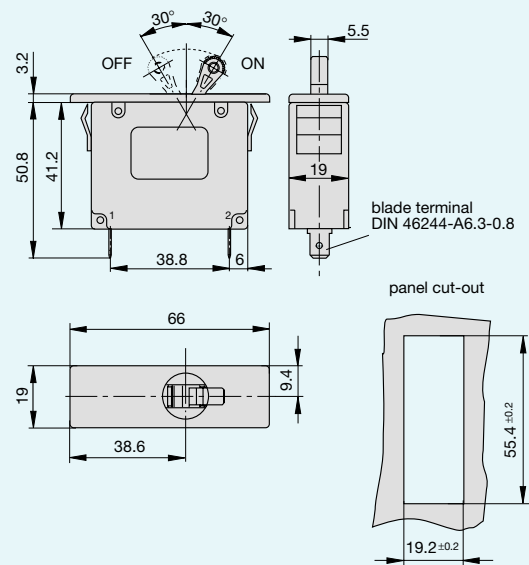

Dimensions

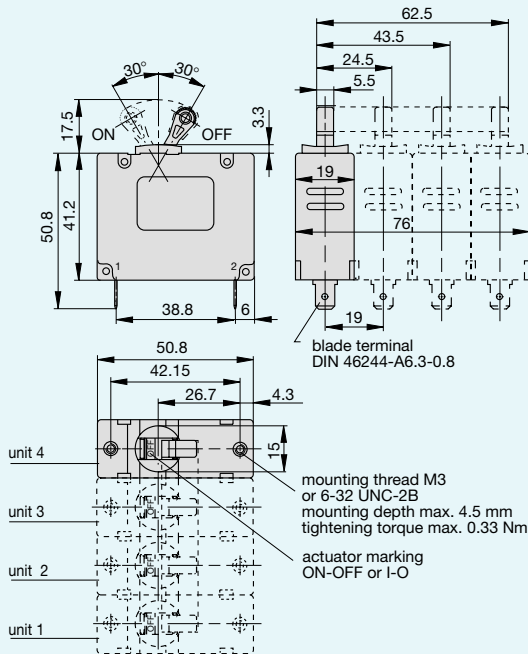

Cut-out dimensions:

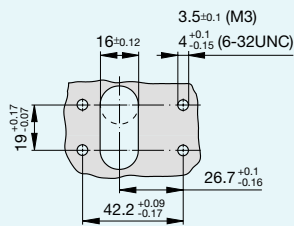

with auxiliary contacts:

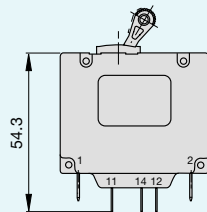

with separate switching and relay circuit 8340-F...-X1..

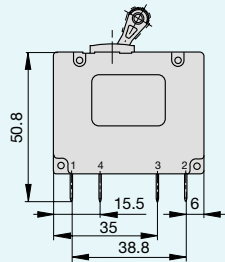

with screw terminals (recommended for $I_N \geq 20$ A)

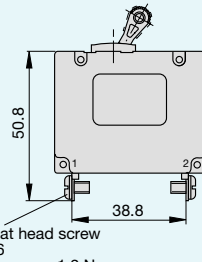

terminal with flat head screw ISO1580-M4x6 tightening torque max.1.2 Nm

snap-in frame

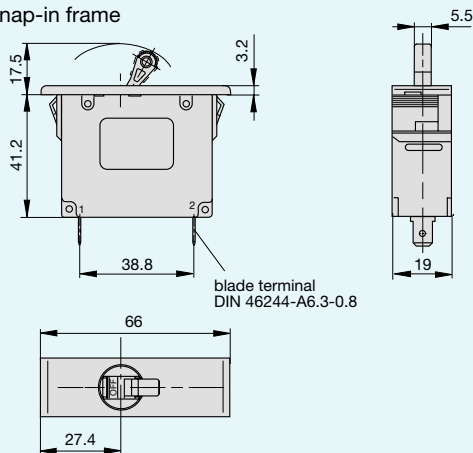

blade terminal DIN 46244-A6.3-0.8

Installation drawing

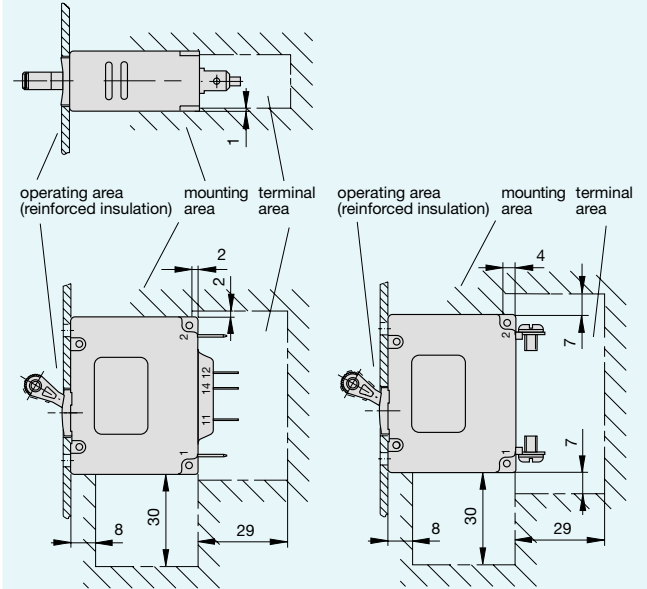

Accessories

Splash covers (transparent), with fixing plate and screws (IP54)

Y303 565 01

1 pole

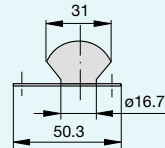

mounting holes

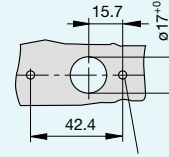

mounting dimensions:
M3 - hole dia. 3.5
6-32 UNC-2B - hole dia. 4

X 211 118 01

2 pole

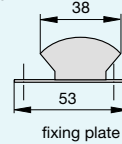

fixing plate

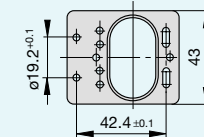

mounting hole

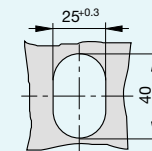

X 211 119 01

3 pole

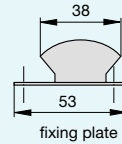

fixing plate

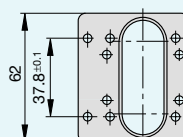

mounting hole

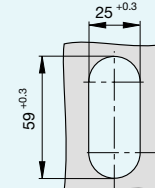

Fixing plate for 2 and 3 pole only.

Typical time/current characteristics at 23 °C

Curve F1 (instantaneous)
for DC

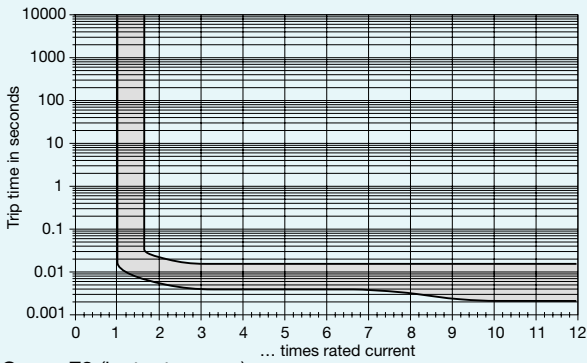

Curve M1 (medium delay)
for DC

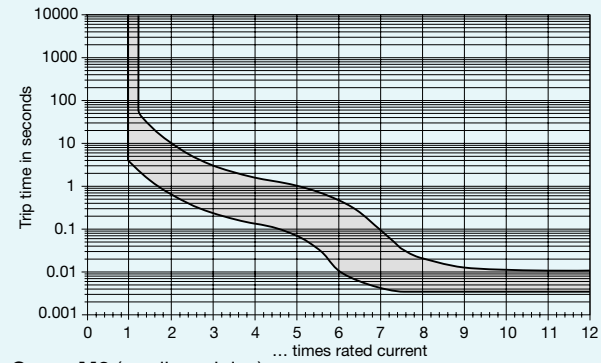

Curve F2 (instantaneous)
for AC 50/60 Hz

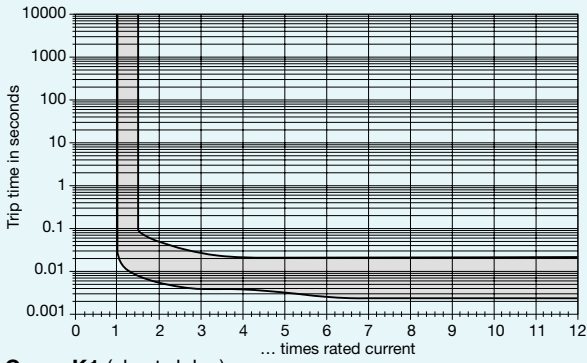

Curve M2 (medium delay)
for AC 50/60 Hz

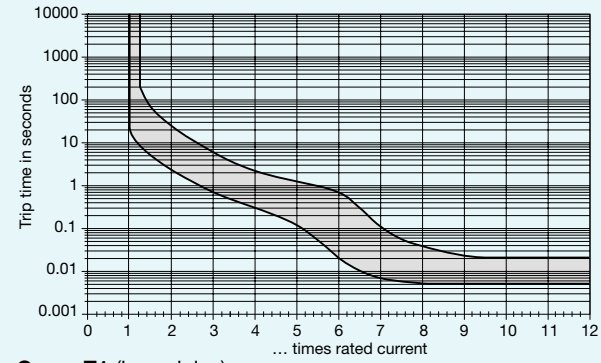

Curve K1 (short delay)
for DC

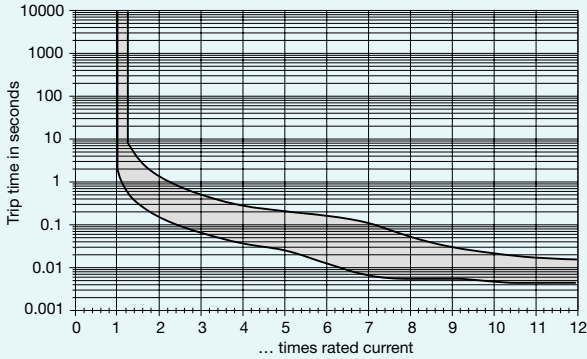

Curve T1 (long delay)
for DC

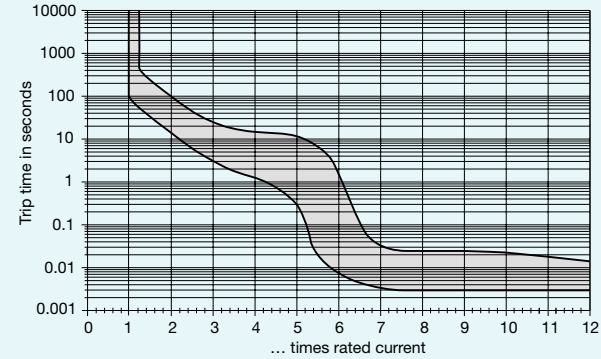

Curve K2 (short delay)
for AC 50/60 Hz

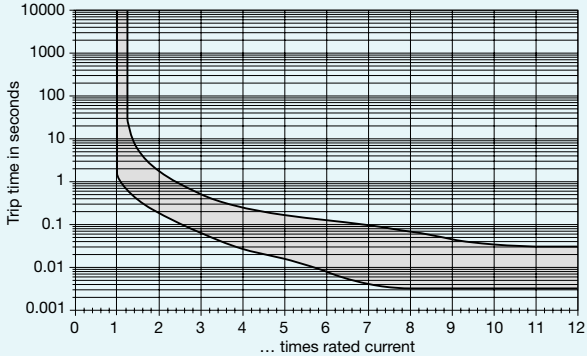

Curve T2 (long delay)
for AC 50/60 Hz

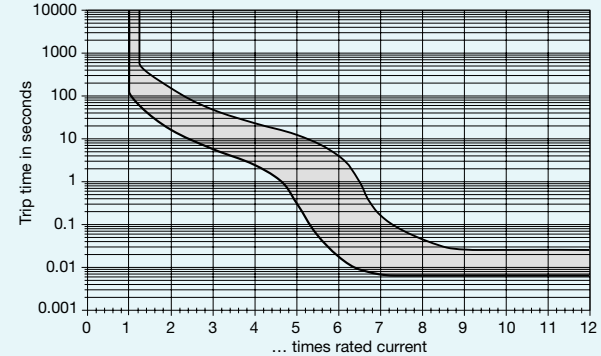

N.B. All curves are for mounting planes 1, 2, 3, 4. Other characteristic curves to special order (e.g. pulse delayed, for high inrush currents or capacitive loads).