

Distinctive Characteristics

Ultra-miniature size allows high density mounting, and extremely light weight of 0.25 gram makes these switches ideal for handheld equipment.

Totally sealed body construction prevents contact contamination and allows time- and money-saving automated soldering and cleaning.

Award-winning STC contact mechanism with benefits unavailable in conventional mechanisms: smoother, positive detent actuation, increased contact stability and unparalleled logic-level reliability. (Additional STC details in Terms & Acronyms; see Supplement section.)

.100" x .100" (2.54mm x 2.54mm) terminal spacing conforms to standard PC board grid-spacing. Round terminals facilitate easier through-hole mounting on PC boards.

Matching indicators available and shown at the end of Section M.

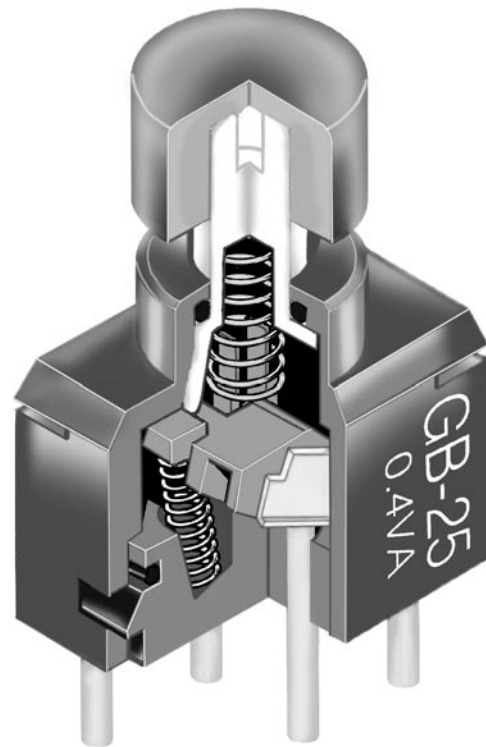

Actual Size

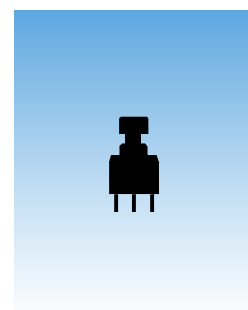

General Specifications

Electrical Capacity (Resistive Load)

Logic Level: 0.4VA maximum @ 28V AC/DC maximum
(Applicable Range 0.1mA ~ 0.1A @ 20mV ~ 28V)
Note: Find additional explanation of operating range in Supplement section.

Other Ratings

Contact Resistance: 80 milliohms maximum
Insulation Resistance: 500 megohms minimum @ 500V DC
Dielectric Strength: 500V AC minimum for 1 minute minimum
Mechanical Life: 50,000 operations minimum
Electrical Life: 50,000 operations minimum
Nominal Operating Force: 1.70N
Travel: Pretravel .035" (0.9mm); Overtravel .008" (0.2mm); Total Travel .043" (1.1mm)

Materials & Finishes

Actuator: Polyacetal
Case: Glass fiber reinforced polyamide
Sealing Rings: Nitrile butadiene rubber
Movable Contacts: Phosphor bronze with gold plating
Stationary Contacts: Phosphor bronze with gold plating
Base: Glass fiber reinforced polyamide
Terminals: Phosphor bronze with gold plating

Environmental Data

Operating Temp Range: -30°C through +85°C (-22°F through +185°F)
Humidity: 90 ~ 95% humidity for 96 hours @ 40°C (104°F)
Vibration: 10 ~ 55Hz with peak-to-peak amplitude of 1.5mm traversing the frequency range & returning in 1 minute; 3 right angled directions for 2 hours
Shock: 50G (490m/s²) acceleration (tested in 6 right angled directions, with 5 shocks in each direction)

Installation

Cap Installation Force: 39.1N (8.8 lbf) maximum downward force on actuator

PCB Processing

Soldering: Wave Soldering Recommended: See Profile A in Supplement section.
Manual Soldering: See Profile A in Supplement section.
Cleaning: Automated cleaning. See Cleaning specifications in Supplement section.

Standards & Certifications

UL Recognition or CSA Certification: The GB Series pushbuttons have not been tested for UL recognition or CSA certification. These switches are designed for use in a low-voltage, low-current, logic-level circuit. When used as intended in a logic-level circuit, the results do not produce hazardous energy.

TYPICAL SWITCH ORDERING EXAMPLE

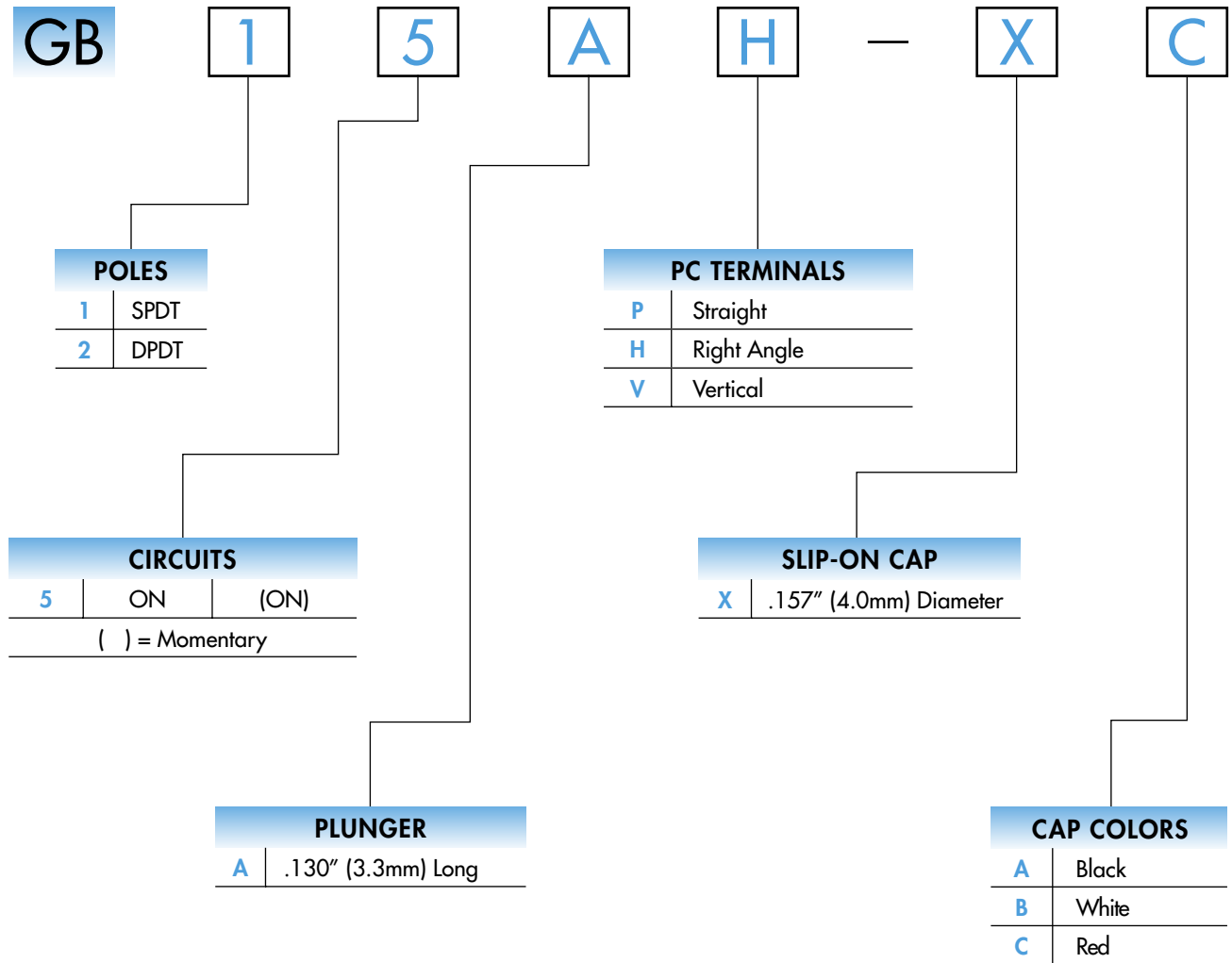

DESCRIPTION FOR TYPICAL ORDERING EXAMPLE

GB15AH-XC

.130" (3.3mm) Long Plunger with
.157" (4.0mm) Diameter Red Cap



SPDT
ON-(ON) Circuit
Right Angle PC Terminals

POLES & CIRCUITS

Pole	Model	Plunger Position () = Momentary		Connected Terminals		Throw & Schematics	
		Normal	Down	Normal	Down		
						Note: Terminal numbers are not actually on the switch.	
SP	GB15	ON	(ON)	5-6	5-4		
DP	GB25	ON	(ON)	5-6 2-3	5-4 2-1		

PLUNGER

A .130" (3.3mm) Long Plunger

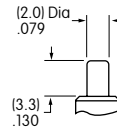

PC TERMINALS

P Straight

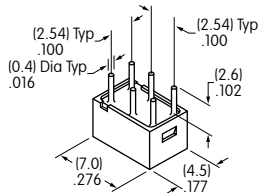

H Right Angle

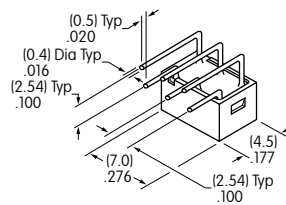

V Vertical

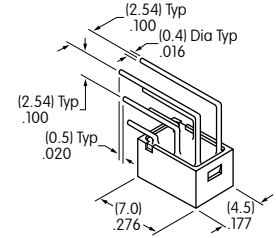

SLIP-ON CAP & COLORS

X AT4063
.157" (4.0mm) Diameter Slip-on Cap

Material: Polyamide

Finish: Glossy



Actual Size

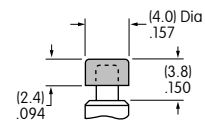

Cap Colors Available:

A Black

B White

C Red

TYPICAL SWITCH DIMENSIONS

Straight PC

Single & Double Pole

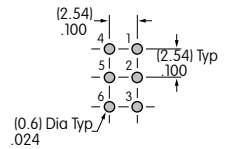
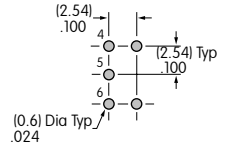
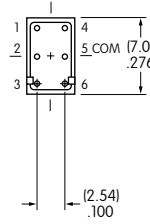
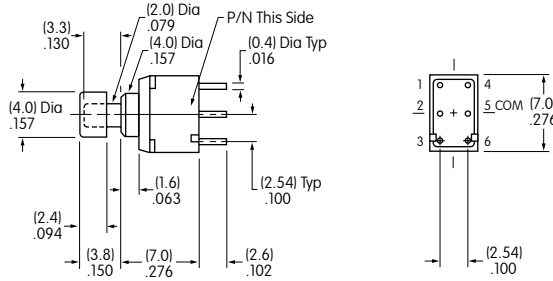
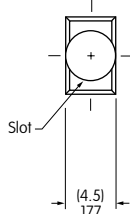

GB25AP-XC

On single pole switches terminals 1 & 3 are support pins.

Right Angle PC

Single & Double Pole

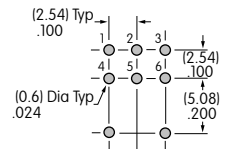
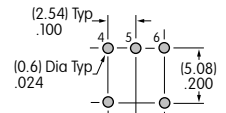
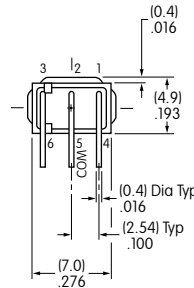
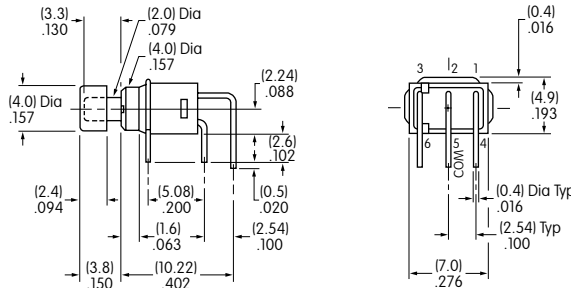
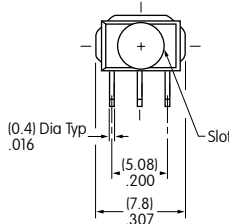

GB25AH-XC

Vertical PC

Single & Double Pole

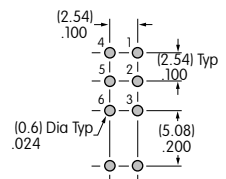
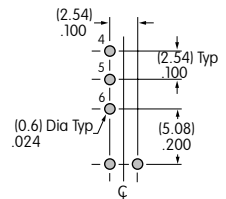
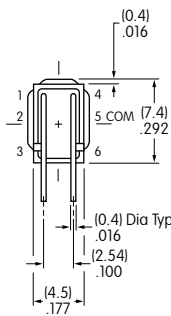
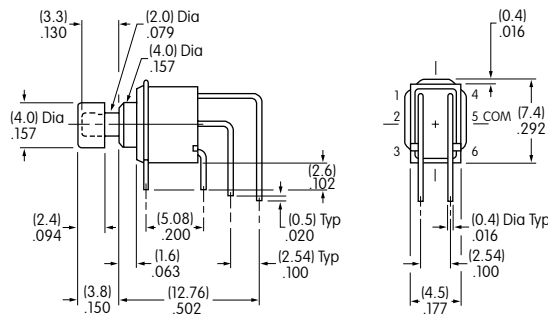
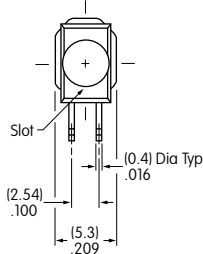

GB25AV-XC