

HITACHI

KAOHSIUNG HITACHI
ELECTRONICS CO.,LTD
P.O. BOX 26-27
2,13TH EAST ST. K.E.P.Z.
KAOHSIUNG TAIWAN R.O.C.
TEL:(07) 821-5811 (7 LINE)
FAX:(07) 821-5815

FOR MESSRS : _____

DATE : Jun.27,2007

CUSTOMER'S ACCEPTANCE SPECIFICATIONS

TX31D55VM2BAA

C O N T E N T S

No.	ITEM	SHEET No.	PAGE
1	COVER	7B64PS 2701- TX31D55VM2BAA-3	1-1/1
2	RECORD OF REVISION	7B64PS 2702- TX31D55VM2BAA-3	2-1/3~3/3
3	GENERAL DATA	7B64PS 2703- TX31D55VM2BAA-3	3-1/1
4	ABSOLUTE MAXIMUM RATINGS	7B64PS 2704- TX31D55VM2BAA-3	4-1/2~2/2
5	ELECTRICAL CHARACTERISTICS	7B64PS 2705- TX31D55VM2BAA-3	5-1/2~2/2
6	OPTICAL CHARACTERISTICS	7B64PS 2706- TX31D55VM2BAA-3	6-1/2~2/2
7	BLOCK DIAGRAM	7B64PS 2707- TX31D55VM2BAA-3	7-1/1
8	INTERFACE PIN CONNECTION	7B64PS 2708- TX31D55VM2BAA-3	8-1/2~2/2
9	INTERFACE TIMNG	7B64PS 2709- TX31D55VM2BAA-3	9-1/3~3/3
10	DIMENSIONAL OUTLINE	7B64PS 2710- TX31D55VM2BAA-3	10-1/2~2/2
11	DESIGNATION OF LOT MARK	7B64PS 2711- TX31D55VM2BAA-3	11-1/1
12	COSMETIC SPECIFICATION	7B64PS 2712- TX31D55VM2BAA-3	12-1/3~3/3
13	PRECAUTION	7B64PS 2713- TX31D55VM2BAA-3	13-1/4~4/4

*When product will be discontinued, customer will be informed by HITACHI with twelve months prior to discontinuation.

ACCEPTED BY: _____

PROPOSED BY: *Elton Liu*

KAOHSIUNG HITACHI ELECTRONICS CO.,LTD.	Sh. No.	7B64PS 2701- TX31D55VM2BAA-3	PAGE	1-1/1
---	------------	------------------------------	------	-------

RECORD OF REVISION

DATE	SHEET No.	SUMMARY																																																																								
Sep.29,'06	7B64PS 2705 – TX31D55VM2BAA-2 PAGE 5 – 1/2	<p>5.1 TFT-LCD MODULE Revised</p> <table border="1" style="width: 100%; border-collapse: collapse; margin-bottom: 10px;"> <thead> <tr> <th>Item</th> <th>Symbol</th> <th>Typ.</th> <th>Max.</th> </tr> </thead> <tbody> <tr> <td>Power Supply Current</td> <td>IDD</td> <td>(300)</td> <td>(400)</td> </tr> </tbody> </table> <p style="text-align: center;">↓</p> <table border="1" style="width: 100%; border-collapse: collapse; margin-bottom: 10px;"> <thead> <tr> <th>Item</th> <th>Symbol</th> <th>Typ.</th> <th>Max.</th> </tr> </thead> <tbody> <tr> <td>Power Supply Current</td> <td>IDD</td> <td>300</td> <td>400</td> </tr> </tbody> </table> <p>5.2 BACK-LIGHT UNIT Revised</p> <table border="1" style="width: 100%; border-collapse: collapse; margin-bottom: 10px;"> <thead> <tr> <th>Item</th> <th>Symbol</th> <th>Min.</th> <th>Typ.</th> <th>Max.</th> </tr> </thead> <tbody> <tr> <td>Lamp Current</td> <td>IL</td> <td>(4.0)</td> <td>(6.0)</td> <td>(7.0)</td> </tr> <tr> <td>Lamp Voltage</td> <td>VL</td> <td>-</td> <td>(1000)</td> <td>-</td> </tr> <tr> <td>Frequency</td> <td>fL</td> <td>(40)</td> <td>-</td> <td>(70)</td> </tr> <tr> <td rowspan="2">Starting Lamp Voltage</td> <td rowspan="2">VS</td> <td>(1400)</td> <td>-</td> <td>-</td> </tr> <tr> <td>(1600)</td> <td>-</td> <td>-</td> </tr> </tbody> </table> <p style="text-align: center;">↓</p> <table border="1" style="width: 100%; border-collapse: collapse;"> <thead> <tr> <th>Item</th> <th>Symbol</th> <th>Min.</th> <th>Typ.</th> <th>Max.</th> </tr> </thead> <tbody> <tr> <td>Lamp Current</td> <td>IL</td> <td>4.0</td> <td>6.0</td> <td>7.0</td> </tr> <tr> <td>Lamp Voltage</td> <td>VL</td> <td>-</td> <td>1000</td> <td>-</td> </tr> <tr> <td>Frequency</td> <td>fL</td> <td>40</td> <td>-</td> <td>70</td> </tr> <tr> <td rowspan="2">Starting Lamp Voltage</td> <td rowspan="2">VS</td> <td>1400</td> <td>-</td> <td>-</td> </tr> <tr> <td>1600</td> <td>-</td> <td>-</td> </tr> </tbody> </table>	Item	Symbol	Typ.	Max.	Power Supply Current	IDD	(300)	(400)	Item	Symbol	Typ.	Max.	Power Supply Current	IDD	300	400	Item	Symbol	Min.	Typ.	Max.	Lamp Current	IL	(4.0)	(6.0)	(7.0)	Lamp Voltage	VL	-	(1000)	-	Frequency	fL	(40)	-	(70)	Starting Lamp Voltage	VS	(1400)	-	-	(1600)	-	-	Item	Symbol	Min.	Typ.	Max.	Lamp Current	IL	4.0	6.0	7.0	Lamp Voltage	VL	-	1000	-	Frequency	fL	40	-	70	Starting Lamp Voltage	VS	1400	-	-	1600	-	-
Item	Symbol	Typ.	Max.																																																																							
Power Supply Current	IDD	(300)	(400)																																																																							
Item	Symbol	Typ.	Max.																																																																							
Power Supply Current	IDD	300	400																																																																							
Item	Symbol	Min.	Typ.	Max.																																																																						
Lamp Current	IL	(4.0)	(6.0)	(7.0)																																																																						
Lamp Voltage	VL	-	(1000)	-																																																																						
Frequency	fL	(40)	-	(70)																																																																						
Starting Lamp Voltage	VS	(1400)	-	-																																																																						
		(1600)	-	-																																																																						
Item	Symbol	Min.	Typ.	Max.																																																																						
Lamp Current	IL	4.0	6.0	7.0																																																																						
Lamp Voltage	VL	-	1000	-																																																																						
Frequency	fL	40	-	70																																																																						
Starting Lamp Voltage	VS	1400	-	-																																																																						
		1600	-	-																																																																						

RECORD OF REVISION

DATE	SHEET No.	SUMMARY																																																																																																																																																																																	
Sep.29,'06	7B64PS 2706 – TX31D55VM2BAA-2 PAGE 6 – 1/2	6. OPTICAL CHARACTERISTICS Revised																																																																																																																																																																																	
		<table border="1"> <thead> <tr> <th>Item</th> <th>Symbol</th> <th>Condition</th> <th>Min.</th> <th>Typ.</th> <th>Max.</th> </tr> </thead> <tbody> <tr> <td>Contrast Ratio</td> <td>CR</td> <td rowspan="10">$\theta=0^\circ$ 1)</td> <td>(200)</td> <td>(350)</td> <td>-</td> </tr> <tr> <td rowspan="2">Response Time</td> <td>RISE</td> <td>ton</td> <td>-</td> <td>(25)</td> <td>(40)</td> </tr> <tr> <td>FALL</td> <td>toff</td> <td>-</td> <td>(15)</td> <td>(30)</td> </tr> <tr> <td>Brightness of White</td> <td>Bwh</td> <td>(300)</td> <td>(350)</td> <td>-</td> </tr> <tr> <td>Brightness Uniformity</td> <td>Buni</td> <td>70</td> <td>-</td> <td>-</td> </tr> <tr> <td rowspan="8">Color Chromaticity (CIE)</td> <td rowspan="2">Red</td> <td>x</td> <td>(0.60)</td> <td>(0.65)</td> <td>(0.70)</td> </tr> <tr> <td>y</td> <td>(0.27)</td> <td>(0.32)</td> <td>(0.37)</td> </tr> <tr> <td rowspan="2">Green</td> <td>x</td> <td>(0.23)</td> <td>(0.28)</td> <td>(0.33)</td> </tr> <tr> <td>y</td> <td>(0.56)</td> <td>(0.61)</td> <td>(0.66)</td> </tr> <tr> <td rowspan="2">Blue</td> <td>x</td> <td>(0.09)</td> <td>(0.14)</td> <td>(0.19)</td> </tr> <tr> <td>y</td> <td>(0.02)</td> <td>(0.07)</td> <td>(0.12)</td> </tr> <tr> <td rowspan="2">White</td> <td>x</td> <td>(0.27)</td> <td>(0.32)</td> <td>(0.37)</td> </tr> <tr> <td>y</td> <td>(0.28)</td> <td>(0.33)</td> <td>(0.38)</td> </tr> <tr> <td rowspan="4">Viewing Angle (CR \geq 10)</td> <td rowspan="2">x - x'</td> <td>θ_x $\theta=0^\circ$</td> <td>(50)</td> <td>(65)</td> <td>-</td> </tr> <tr> <td>$\theta_{x'}$ $\theta=180^\circ$</td> <td>(50)</td> <td>(65)</td> <td>-</td> </tr> <tr> <td rowspan="2">y - y'</td> <td>θ_y $\theta=90^\circ$</td> <td>(50)</td> <td>(60)</td> <td>-</td> </tr> <tr> <td>$\theta_{y'}$ $\theta=270^\circ$</td> <td>(50)</td> <td>(70)</td> <td>-</td> </tr> </tbody> </table> <p align="center">↓</p> <table border="1"> <thead> <tr> <th>Item</th> <th>Symbol</th> <th>Condition</th> <th>Min.</th> <th>Typ.</th> <th>Max.</th> </tr> </thead> <tbody> <tr> <td>Contrast Ratio</td> <td>CR</td> <td rowspan="10">$\theta=0^\circ$ 1)</td> <td>200</td> <td>350</td> <td>-</td> </tr> <tr> <td rowspan="2">Response Time</td> <td>RISE</td> <td>ton</td> <td>-</td> <td>25</td> <td>40</td> </tr> <tr> <td>FALL</td> <td>toff</td> <td>-</td> <td>15</td> <td>30</td> </tr> <tr> <td>Brightness of White</td> <td>Bwh</td> <td>300</td> <td>(350)</td> <td>-</td> </tr> <tr> <td>Brightness Uniformity</td> <td>Buni</td> <td>70</td> <td>-</td> <td>-</td> </tr> <tr> <td rowspan="8">Color Chromaticity (CIE)</td> <td rowspan="2">Red</td> <td>x</td> <td>0.60</td> <td>0.65</td> <td>0.70</td> </tr> <tr> <td>y</td> <td>0.27</td> <td>0.32</td> <td>0.37</td> </tr> <tr> <td rowspan="2">Green</td> <td>x</td> <td>0.23</td> <td>0.28</td> <td>0.33</td> </tr> <tr> <td>y</td> <td>0.56</td> <td>0.61</td> <td>0.66</td> </tr> <tr> <td rowspan="2">Blue</td> <td>x</td> <td>0.09</td> <td>0.14</td> <td>0.19</td> </tr> <tr> <td>y</td> <td>0.02</td> <td>0.07</td> <td>0.12</td> </tr> <tr> <td rowspan="2">White</td> <td>x</td> <td>0.27</td> <td>0.32</td> <td>0.37</td> </tr> <tr> <td>y</td> <td>0.28</td> <td>0.33</td> <td>0.38</td> </tr> <tr> <td rowspan="4">Viewing Angle (CR \geq 10)</td> <td rowspan="2">x - x'</td> <td>θ_x $\theta=0^\circ$</td> <td>50</td> <td>65</td> <td>-</td> </tr> <tr> <td>$\theta_{x'}$ $\theta=180^\circ$</td> <td>50</td> <td>65</td> <td>-</td> </tr> <tr> <td rowspan="2">y - y'</td> <td>θ_y $\theta=90^\circ$</td> <td>50</td> <td>60</td> <td>-</td> </tr> <tr> <td>$\theta_{y'}$ $\theta=270^\circ$</td> <td>50</td> <td>70</td> <td>-</td> </tr> </tbody> </table>	Item	Symbol	Condition	Min.	Typ.	Max.	Contrast Ratio	CR	$\theta=0^\circ$ 1)	(200)	(350)	-	Response Time	RISE	ton	-	(25)	(40)	FALL	toff	-	(15)	(30)	Brightness of White	Bwh	(300)	(350)	-	Brightness Uniformity	Buni	70	-	-	Color Chromaticity (CIE)	Red	x	(0.60)	(0.65)	(0.70)	y	(0.27)	(0.32)	(0.37)	Green	x	(0.23)	(0.28)	(0.33)	y	(0.56)	(0.61)	(0.66)	Blue	x	(0.09)	(0.14)	(0.19)	y	(0.02)	(0.07)	(0.12)	White	x	(0.27)	(0.32)	(0.37)	y	(0.28)	(0.33)	(0.38)	Viewing Angle (CR \geq 10)	x - x'	θ_x $\theta=0^\circ$	(50)	(65)	-	$\theta_{x'}$ $\theta=180^\circ$	(50)	(65)	-	y - y'	θ_y $\theta=90^\circ$	(50)	(60)	-	$\theta_{y'}$ $\theta=270^\circ$	(50)	(70)	-	Item	Symbol	Condition	Min.	Typ.	Max.	Contrast Ratio	CR	$\theta=0^\circ$ 1)	200	350	-	Response Time	RISE	ton	-	25	40	FALL	toff	-	15	30	Brightness of White	Bwh	300	(350)	-	Brightness Uniformity	Buni	70	-	-	Color Chromaticity (CIE)	Red	x	0.60	0.65	0.70	y	0.27	0.32	0.37	Green	x	0.23	0.28	0.33	y	0.56	0.61	0.66	Blue	x	0.09	0.14	0.19	y	0.02	0.07	0.12	White	x	0.27	0.32	0.37	y	0.28	0.33	0.38	Viewing Angle (CR \geq 10)	x - x'	θ_x $\theta=0^\circ$	50	65	-	$\theta_{x'}$ $\theta=180^\circ$	50	65	-	y - y'	θ_y $\theta=90^\circ$	50	60	-	$\theta_{y'}$ $\theta=270^\circ$	50	70
Item	Symbol	Condition	Min.	Typ.	Max.																																																																																																																																																																														
Contrast Ratio	CR	$\theta=0^\circ$ 1)	(200)	(350)	-																																																																																																																																																																														
Response Time	RISE		ton	-	(25)	(40)																																																																																																																																																																													
	FALL		toff	-	(15)	(30)																																																																																																																																																																													
Brightness of White	Bwh		(300)	(350)	-																																																																																																																																																																														
Brightness Uniformity	Buni		70	-	-																																																																																																																																																																														
Color Chromaticity (CIE)	Red		x	(0.60)	(0.65)	(0.70)																																																																																																																																																																													
			y	(0.27)	(0.32)	(0.37)																																																																																																																																																																													
	Green		x	(0.23)	(0.28)	(0.33)																																																																																																																																																																													
			y	(0.56)	(0.61)	(0.66)																																																																																																																																																																													
	Blue		x	(0.09)	(0.14)	(0.19)																																																																																																																																																																													
		y	(0.02)	(0.07)	(0.12)																																																																																																																																																																														
	White	x	(0.27)	(0.32)	(0.37)																																																																																																																																																																														
		y	(0.28)	(0.33)	(0.38)																																																																																																																																																																														
Viewing Angle (CR \geq 10)	x - x'	θ_x $\theta=0^\circ$	(50)	(65)	-																																																																																																																																																																														
		$\theta_{x'}$ $\theta=180^\circ$	(50)	(65)	-																																																																																																																																																																														
	y - y'	θ_y $\theta=90^\circ$	(50)	(60)	-																																																																																																																																																																														
		$\theta_{y'}$ $\theta=270^\circ$	(50)	(70)	-																																																																																																																																																																														
Item	Symbol	Condition	Min.	Typ.	Max.																																																																																																																																																																														
Contrast Ratio	CR	$\theta=0^\circ$ 1)	200	350	-																																																																																																																																																																														
Response Time	RISE		ton	-	25	40																																																																																																																																																																													
	FALL		toff	-	15	30																																																																																																																																																																													
Brightness of White	Bwh		300	(350)	-																																																																																																																																																																														
Brightness Uniformity	Buni		70	-	-																																																																																																																																																																														
Color Chromaticity (CIE)	Red		x	0.60	0.65	0.70																																																																																																																																																																													
			y	0.27	0.32	0.37																																																																																																																																																																													
	Green		x	0.23	0.28	0.33																																																																																																																																																																													
			y	0.56	0.61	0.66																																																																																																																																																																													
	Blue		x	0.09	0.14	0.19																																																																																																																																																																													
		y	0.02	0.07	0.12																																																																																																																																																																														
	White	x	0.27	0.32	0.37																																																																																																																																																																														
		y	0.28	0.33	0.38																																																																																																																																																																														
Viewing Angle (CR \geq 10)	x - x'	θ_x $\theta=0^\circ$	50	65	-																																																																																																																																																																														
		$\theta_{x'}$ $\theta=180^\circ$	50	65	-																																																																																																																																																																														
	y - y'	θ_y $\theta=90^\circ$	50	60	-																																																																																																																																																																														
		$\theta_{y'}$ $\theta=270^\circ$	50	70	-																																																																																																																																																																														
Jun.27,'07	7B64PS 2707 – TX31D55VM2BAA-3 PAGE 7 – 1/1	Revised 7.2 BACK-LIGHT UNIT GND PIN No.3 → GND PIN No.2																																																																																																																																																																																	
	7B64PS 2708/2710 – TX31D55VM2BAA-3 PAGE 8 – 1/2 PAGE 10 – 2/2	Revised 8.2 BACK LIGHT UNIT / 10.2 BACK SIDE CN2 JST ; BHR – 03VS – 1 → BHR - 02 (8.0) VS - IN																																																																																																																																																																																	

RECORD OF REVISION

DATE	SHEET No.	SUMMARY					
Jun.27,'07	7B64PS 2712 - TX31D55VM2BAA-3 PAGE 12 - 2/3	12.3 COSMETIC SPECIFICATIONS					
		Revised					
		No	ITEM	Max. acceptable number	Unit		
				A-zone			
		4	Stains, Foreign Materials Line shape W : width (mm) L : length (mm)	$W \leq 0.02$	L : Ignore	Ignore	pcs
				$W \leq 0.03$	$L \leq 2.0$	10	
					$L > 2.0$	0	
				$W \leq 0.06$	$L \leq 1.0$	10	
					$L > 1.0$	0	
		$W > 0.06$	-	(See dot shape)			
		5	Stains, Foreign Materials Dot shape D : ave. dia (mm)	$D \leq 0.22$	Ignore	pcs	
				$D \leq 0.33$	5		
				$D > 0.33$	0		
		7	Scratch on polarizer Dot shape D : ave. dia (mm)	$D \leq 0.2$	Ignore	pcs	
				$D \leq 0.4$	10		
				$D > 0.4$	0		
		↓					
		No	ITEM	Max. acceptable number	Unit		
				A-zone			
		4	Stains, Foreign Materials Line shape W : length (mm) L : length (mm)	$W \leq 0.06$	L : Ignore	Ignore	pcs
$W > 0.06$	$L \leq 1.0$			Ignore			
	$L > 1.0$			(See dot shape)			
5	Stains, Foreign Materials Dot shape D : ave. dia (mm)	$D \leq 0.45$	Ignore	pcs			
		$D \leq 0.7$	5	pcs			
7	Scratch on polarizer Dot shape D : ave. dia (mm)	$D > 0.7$	0				
		$D \leq 0.45$	Ignore				
		$D \leq 0.7$	10				
$D > 0.7$	0						

3. GENERAL DATA

The following specifications are applied to the following TFT.
Note : Inverter for Back-Light unit is not built in this module.

Product Name	TX31D55VM2BAA	
Effective Display Area	(H)261.6 x (V)156.96	[mm]
Display Dots	(H)(800x3) x (V)480	
Display Pixels	(H)800 x (V)480	[pixels]
Pixel Pitch	(H)0.327 x (V)0.327	[mm]
Color Pixel Arrangement	R+G+B Vertical Stripe	
Display Mode	Transmissive Mode, Normally White Mode	
Surface Polarizing Film	Anti-Glare Polarizing Film	
Number of Colors	262k	[colors]
Interface	C-MOS (R + G + B 6 bit Digital)	
Color Saturation	60%(typ.) For NTSC	
Viewing Direction	12 O'clock	
Backlight	1pc . of CCFL (U shaped)	
Dimensions Outline	(H)283.0 typ. x (V)173.8 typ. x (t)(12.4 max.)	[mm]
Weight	Approximately 550	[g]

4. ABSOLUTE MAXIMUM RATINGS

4.1 ENVIRONMENTAL ABSOLUTE MAXIMUM RATINGS

Item	Operating		Non-operation		Unit	Note
	Min.	Max.	Min.	Max.		
Temperature	-20	70	-30	70	°C	1),5),6)
Humidity	2)		2)		%RH	1)
Vibration	-	4.9(0.5G)	-	19.6(2G)	m/s ²	3)
Shock	-	29.4(3G)	-	490(50G)	m/s ²	4)
Corrosive Gas	Not Acceptable		Not Acceptable			
Illumination at LCD Surface	-	50,000	-	50,000	lx	
CFL Life time	30,000h (Average) (Note 7)		-		At 25°C I _L =6mA max.	

Notes 1) "Temperature" and "Humidity" shall be measured on panel surface.

The ratings apply to every part of this module and shall not be exceeded.

The operating temperature only guarantee the display can be operated ; regarding the contrast response time, illumination and other features related to the quality are judged by Ta=25°C condition.

Generally the illumination will down and LCD response time will becomes slower when the display operated under a lower temperature environment.

2) Ambient temp. $T_a \leq 40^\circ\text{C}$: 85%RH max. Without condensation.

$T_a > 40^\circ\text{C}$: Absolute humidity must be lower than the humidity of 85% at 40°C Without condensation.

3) Frequency of the vibration shall be between 20 Hz and 50 Hz.
(except resonance point)

4) Pulse width of the shock shall be 3 ms.

5) In Non-operation condition ($T_a > 70^\circ\text{C}$) the TFT-LCD module should be put within 96 hrs.
In Non-operation condition ($T_a < -30^\circ\text{C}$) the TFT-LCD module should be put within 240 hrs and without condensation.

6) In operation condition ($T_a > 70^\circ\text{C}$) the TFT-LCD module should be put within 96 hrs.
In operation condition ($T_a < -20^\circ\text{C}$) the TFT-LCD module should be put within 240 hrs and without condensation.

7) When brightness reached 50% of initial brightness.

4.2 ELECTRICAL ABSOLUTE MAXIMUM RATINGS

4.2.1 TFT-LCD MODULE

VSS=0V

Item	Symbol	Min.	Max.	Unit	Note
Power Supply Voltage for logic	VDD	0	4.0	V	
Input signal Voltage for logic	VI	-0.3	VDD+0.3	V	1)
Electrostatic Durability	VESD0	±100		V	2),3)
	VESD1	±8		kV	4),5)

Notes 1) The specification is applied to pixel data signal, timing signal and clock signal.

2) Discharge circuit to be connected : 200pF - 0Ω, Environmental : 25°C - 70%RH

3) The specification is applied to I/F connector pins.

4) Discharge circuit to be connected : 200pF - 250Ω, Environmental : 25°C - 70%RH

5) The specification is applied to the surface of both a metal bezel and a LCD panel.

4.2.2 BACK-LIGHT UNIT

GND=0V

Item	Symbol	Min.	Max.	Unit	Note
Lamp Current	IL	-	7.0	mArms	1)
Lamp Voltage	VL	-	2000	Vrms	2)

Notes 1) To be measured at GND terminal side

2) The specification is applied at connector pins for back-light units.

5. ELECTRICAL CHARACTERISTICS

5.1 TFT-LCD MODULE

Ta=25°C, VSS=0V

Item	Symbol	Min.	Typ.	Max.	Unit	Note
Power Supply Voltage	VDD	3.0	3.3	3.6	V	
Input Voltage for Logic Circuits	Hi	V _{IH}	2.0	-	VDD	mV
	Lo	V _{IL}	VSS	-	0.8	
Power Supply Current	I _{DD}	-	300	400	mA	1),2)
Vsync Frequency	f _V	-	60	75	Hz	
Hsync Frequency	f _H	-	31.6	39.2	kHz	
DCLK Frequency	f _{CLK}	-	33.3	40	MHz	

Notes 1) The specification is applied to pixel data signal, timing signal and clock signal.
 2) f_V=60Hz, f_{CLK}=33.3MHz, VDD=3.3V, DC Current.

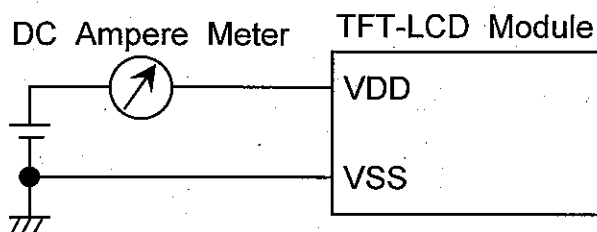

Typical value is measured when displaying Black raster.

Maximum is measured when displaying Vertical-stripe pattern of 2 pixel pitch.

3) Current capacity for VDD power source should be larger than 2A.

This TFT-LCD Module has a fuse (1.0A).

5.2 BACK-LIGHT UNIT

Ta=25°C

Item	Symbol	Min.	Typ.	Max.	Unit	Note
Lamp Current	I _L	4.0	6.0	7.0	mArms	1),2)
Lamp Voltage	V _L	-	1000	-	V _{rms}	
Frequency	f _L	40	-	70	kHz	3)
Starting Lamp Voltage	V _S	1400	-	-	V _{rms}	Ta=25°C
		1600	-	-		Ta= 0°C

Notes 1) Larger I_L causes the shorter life of a CCFL.

2) To be measured at GND terminal side

3) Frequency of power supply for a CCFL may cause interference with HSYNC frequency and causes beat or flicker on the display.

Therefore, lamp frequency shall be as different as possible from HSYNC frequency in order to avoid the interference.

4) Starting Lamp Voltage should be kept 1 sec at least.

5) The inverter should be built-in a safety circuit which detects over current, over voltage and distorted wave form of lamp current.

6) Distribution difference of lamp surface temperature should be less than 5°C

7) When the lighting wave form of the inverter is asymmetric, the inclination of mercury is generated. Therefore, please adjust the unbalance ($|I_p^+ - I_p^-| / I_{rms} \times 100\%$) of the lighting current wave form to 10% or less, and Adjust the wave high rate (I_p^+ (or I_p^-)/ I_{rms}) to 1.2~1.63.

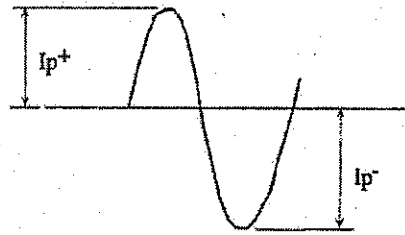

Inverter current wave form.

8) Recommendation inverter : HARISON TOSHIBA LIGHTING Corp.
Type name : HIU - 1718 suitable item

6. OPTICAL CHARACTERISTICS

The following optical characteristics are measured under stable conditions. It takes about 30 minutes to reach stable conditions. The measuring point is the center of display area unless otherwise noted.

The optical characteristics should be measured in a dark room or equivalent state.

- Measuring equipment : Topcon BM-7 Prichard 1980A, or equivalent
- Temperature = 25°C , VDD=3.3V , fV=60Hz , IL=6.0mA

Item		Symbol	Condition	Min.	Typ.	Max.	Unit	Note
Contrast Ratio		CR	$\theta = 0^\circ$ 1)	200	350	-	-	2)
Response Time	RISE	ton		-	25	40	ms	3)
	FALL	toff		-	15	30	ms	3)
Brightness of White		Bwh		300	(350)	-	cd/m ²	
Brightness Uniformity		Buni		70	-	-	%	4)
Color Chromaticity (CIE)	Red	x		0.60	0.65	0.70	-	[Gray scale=255]
		y		0.27	0.32	0.37		
	Green	x		0.23	0.28	0.33		
		y		0.56	0.61	0.66		
	Blue	x		0.09	0.14	0.19		
		y	0.02	0.07	0.12			
	White	x	0.27	0.32	0.37			
		y	0.28	0.33	0.38			
Viewing Angle (CR ≥ 10)	x - x'	θx	$\theta = 0^\circ$	50	65	-	deg.	1)
		$\theta x'$	$\theta = 180^\circ$	50	65	-		
	y - y'	θy	$\theta = 90^\circ$	50	60	-		
		$\theta y'$	$\theta = 270^\circ$	50	70	-		

Note 1) Definition of Viewing Angle

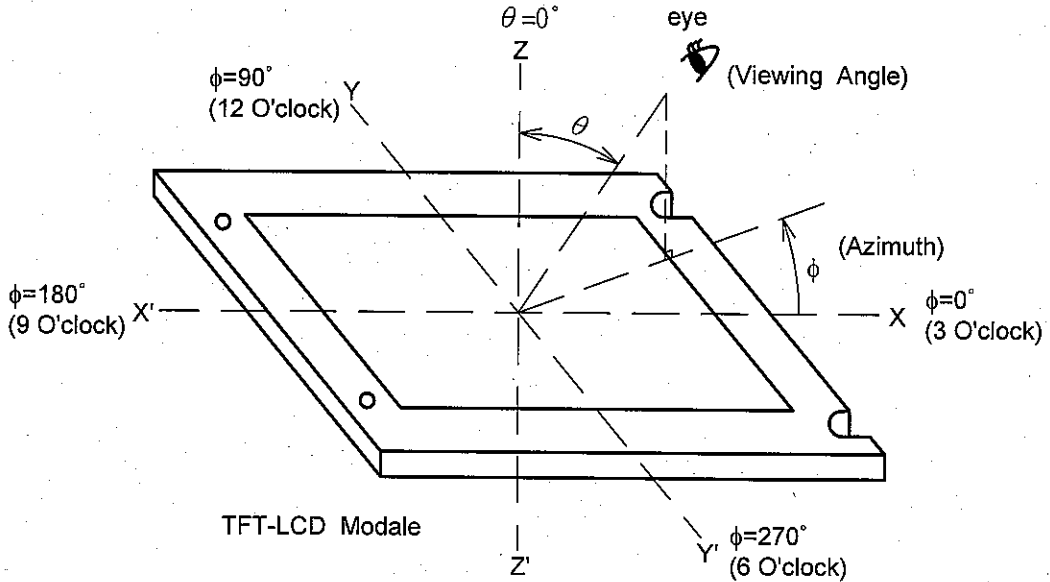

2) Definition of Contrast Ratio(CR) :

$$CR = \frac{\text{Luminance at displaying WHITE}}{\text{Luminance at displaying BLACK}}$$

3) Definition of Response Time

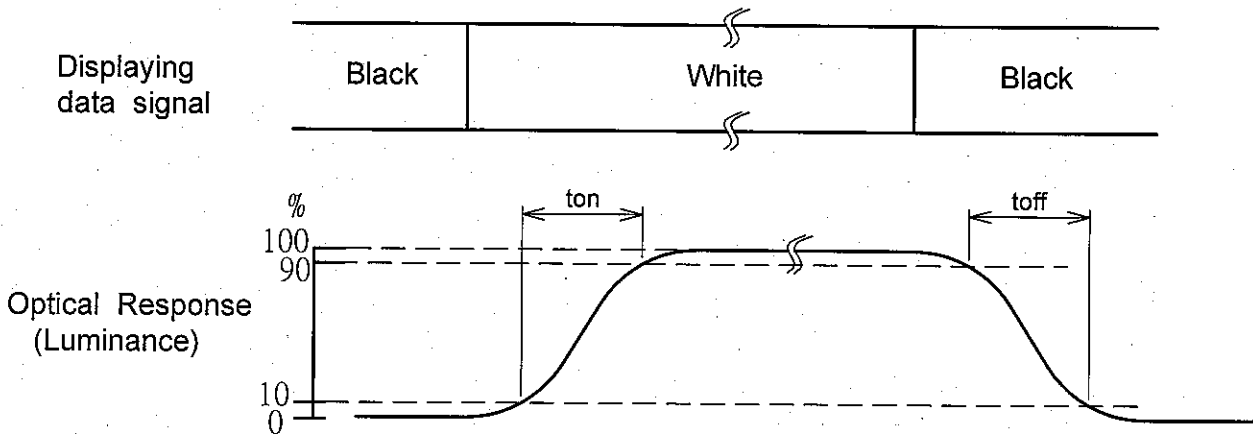

4) Definition of Brightness Uniformity

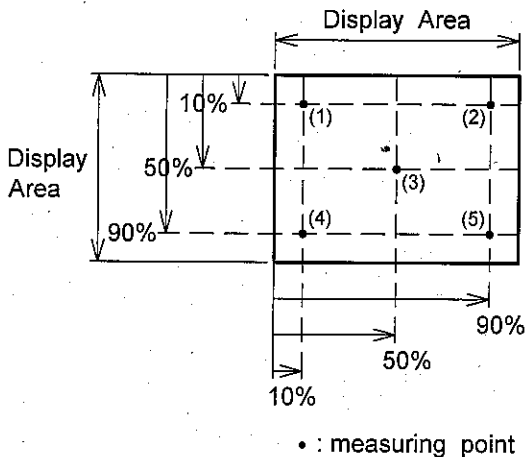

The brightness uniformity (Buni) is defined as the following equation.

$$Buni = \frac{B_{min}}{B_{max}} \times 100$$

where, B_{max} = Maximum brightness among 5 measuring points
 B_{min} = Minimum brightness among 5 measuring points

7. BLOCK DIAGRAM
7.1 TFT-LCD MODULE

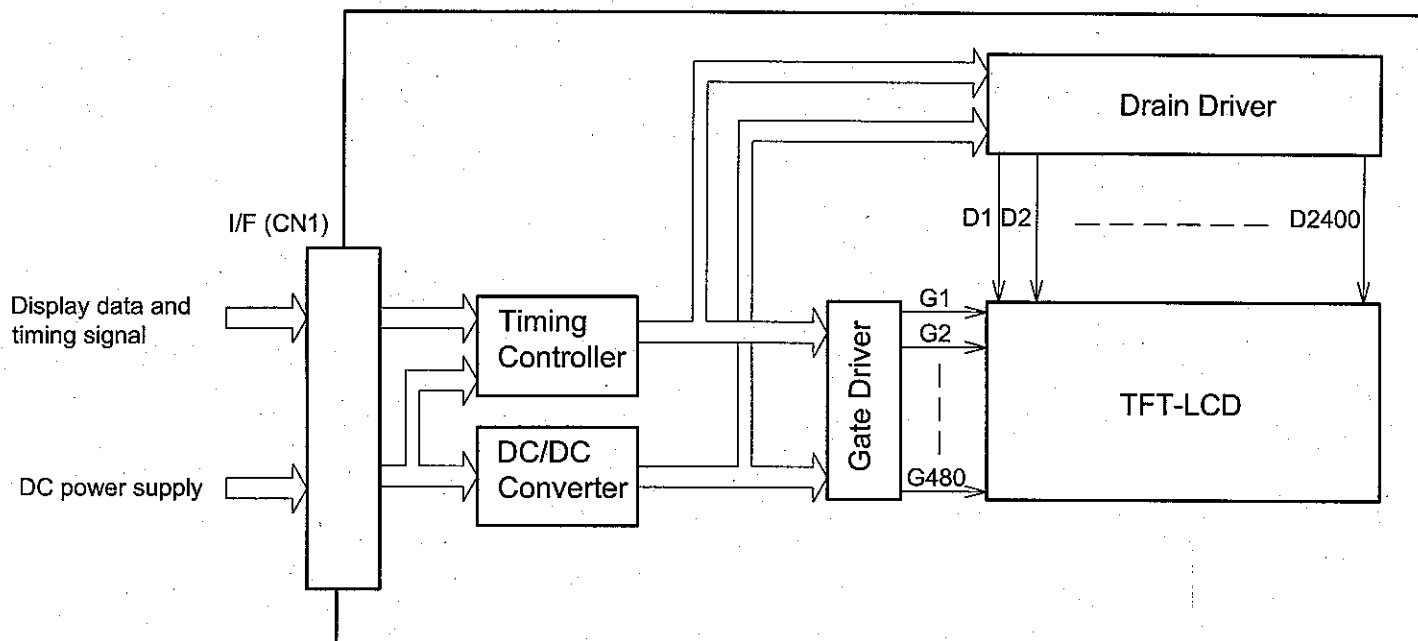

7.2 BACK-LIGHT UNIT

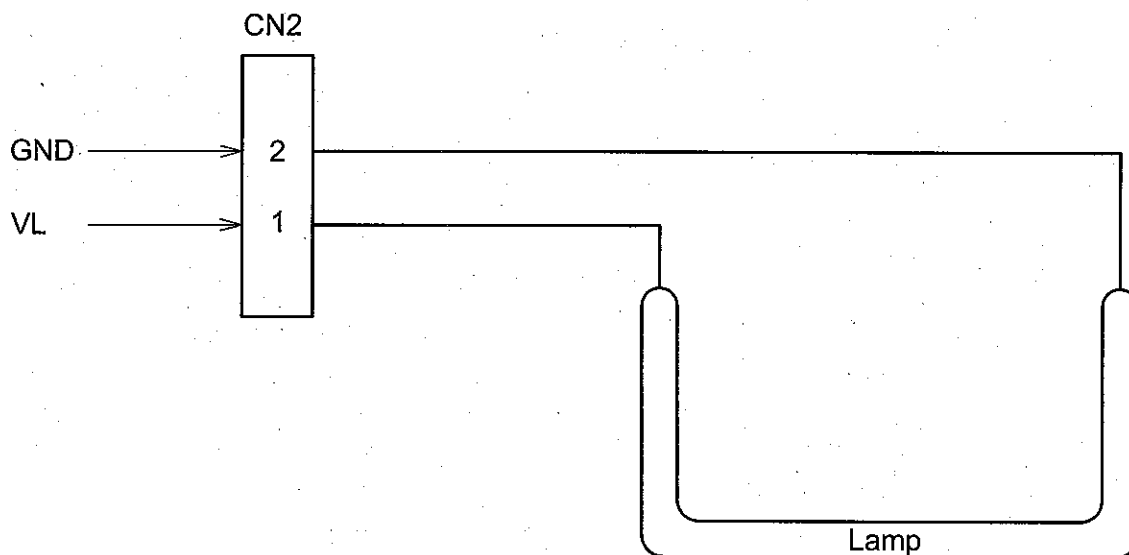

Color of wires from CCFL to CN2
 1 (VL) : Pink
 2 (GND) : White

8. INTERFACE PIN CONNECTION

8.1 TFT-LCD MODULE

CN1 《JAE ; FA5B040HP1R3000》

Pin No.	Symbol	Description	Note
1	VDD	Power Supply (typ. + 3.3V)	1)
2	VDD		
3	VDD		
4	VDD		
5	NC	No Connection	4)
6	DTMG	Display timing signal	
7	VSS	GND (0V)	2)
8	NC	No Connection	4)
9	VSS	GND (0V)	2)
10	TEST	TEST Pin	3)
11	VSS	GND (0V)	2)
12	B5	Display data (Blue)	
13	B4		
14	B3		
15	VSS	GND (0V)	2)
16	B2	Display data (Blue)	
17	B1		
18	B0		
19	VSS	GND (0V)	2)
20	G5	Display data (Green)	
21	G4		
22	G3		
23	VSS	GND (0V)	2)
24	G2	Display data (Green)	
25	G1		
26	G0		
27	VSS	GND (0V)	2)
28	R5	Display data (Red)	
29	R4		
30	R3		
31	VSS	GND (0V)	2)
32	R2	Display data (Red)	
33	R1		
34	R0		
35	TEST	TEST Pin	3)
36	VSS	GND (0V)	2)
37	VSS		
38	DCLK	Dot Clock	
39	VSS	GND (0V)	2)
40	VSS		

Notes 1) All VDD pins shall be connected to +3.3V(Typ.).

2) All VSS pins shall be grounded. Metal bezel is internally connected to VSS.

3) Keep open electrically. HITACHI test use only.

4) Unconnected to the module

5) This connector is gilding. FFC or FPC to connect should use a gilding.

8.2 BACK-LIGHT UNIT

CN2 《JST ; BHR-02(8.0)VS-IN》

Pin No.	Symbol	Description
1	VL	Power Supply for CCFL
2	GND	GND(0V)

8.3 RELATIONSHIP BETWEEN DISPLAY COLORS AND INPUT SIGNALS

color	Input	Red Data						Green Data						Blue Data					
		R5	R4	R3	R2	R1	R0	G5	G4	G3	G2	G1	G0	B5	B4	B3	B2	B1	B0
		MSB			LSB			MSB			LSB			MSB			LSB		
Basic Color	Black	0	0	0	0	0	0	0	0	0	0	0	0	0	0	0	0	0	0
	Red(63)	1	1	1	1	1	1	0	0	0	0	0	0	0	0	0	0	0	0
	Green(63)	0	0	0	0	0	0	1	1	1	1	1	1	0	0	0	0	0	0
	Blue(63)	0	0	0	0	0	0	0	0	0	0	0	0	1	1	1	1	1	1
	Cyan	0	0	0	0	0	0	1	1	1	1	1	1	1	1	1	1	1	1
	Magenta	1	1	1	1	1	1	0	0	0	0	0	0	1	1	1	1	1	1
	Yellow	1	1	1	1	1	1	1	1	1	1	1	1	0	0	0	0	0	0
	White	1	1	1	1	1	1	1	1	1	1	1	1	1	1	1	1	1	1
Red	Black	0	0	0	0	0	0	0	0	0	0	0	0	0	0	0	0	0	0
	Red(1)	0	0	0	0	0	1	0	0	0	0	0	0	0	0	0	0	0	0
	Red(2)	0	0	0	0	1	0	0	0	0	0	0	0	0	0	0	0	0	0
	:	:	:	:	:	:	:	:	:	:	:	:	:	:	:	:	:	:	:
	:	:	:	:	:	:	:	:	:	:	:	:	:	:	:	:	:	:	:
	Red(62)	1	1	1	1	1	0	0	0	0	0	0	0	0	0	0	0	0	0
	Red(63)	1	1	1	1	1	1	0	0	0	0	0	0	0	0	0	0	0	0
Green	Black	0	0	0	0	0	0	0	0	0	0	0	0	0	0	0	0	0	0
	Green(1)	0	0	0	0	0	0	0	0	0	0	1	0	0	0	0	0	0	0
	Green(2)	0	0	0	0	0	0	0	0	0	1	0	0	0	0	0	0	0	0
	:	:	:	:	:	:	:	:	:	:	:	:	:	:	:	:	:	:	:
	:	:	:	:	:	:	:	:	:	:	:	:	:	:	:	:	:	:	:
	Green(62)	0	0	0	0	0	0	1	1	1	1	1	0	0	0	0	0	0	0
	Green(63)	0	0	0	0	0	0	1	1	1	1	1	1	0	0	0	0	0	0
Blue	Black	0	0	0	0	0	0	0	0	0	0	0	0	0	0	0	0	0	0
	Blue(1)	0	0	0	0	0	0	0	0	0	0	0	0	0	0	0	0	0	1
	Blue(2)	0	0	0	0	0	0	0	0	0	0	0	0	0	0	0	0	1	0
	:	:	:	:	:	:	:	:	:	:	:	:	:	:	:	:	:	:	:
	:	:	:	:	:	:	:	:	:	:	:	:	:	:	:	:	:	:	:
	Blue(62)	0	0	0	0	0	0	0	0	0	0	0	0	1	1	1	1	1	0
	Blue(63)	0	0	0	0	0	0	0	0	0	0	0	0	1	1	1	1	1	1

Notes 1) Definition of gray scale :

Color(n)---Number in parenthesis indicates gray scale level.

LARGER n corresponds to brighter level.

2) Data : 1 : High, 0 : Low

9. INTERFACE TIMING

9.1 TIMING CHART

(Data : Latched at Fall edge of DCLK)

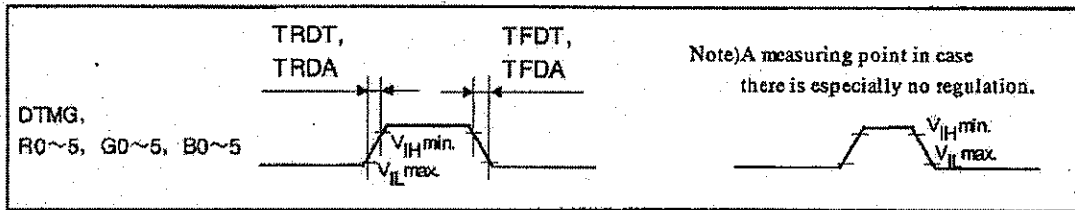

DCLK-DATA TIMING

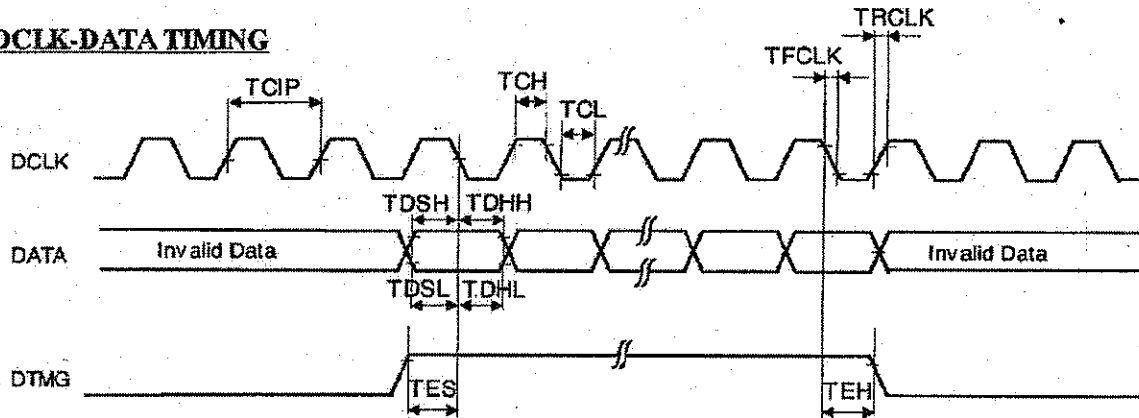

VERTICAL TIMING

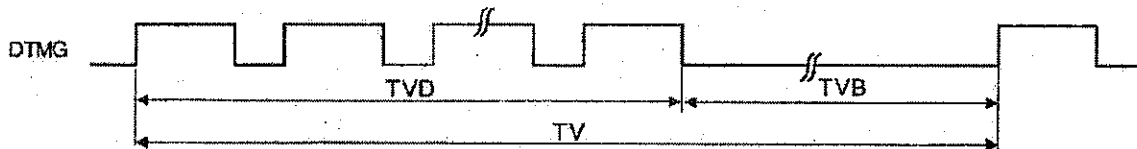

HORIZONTAL TIMING

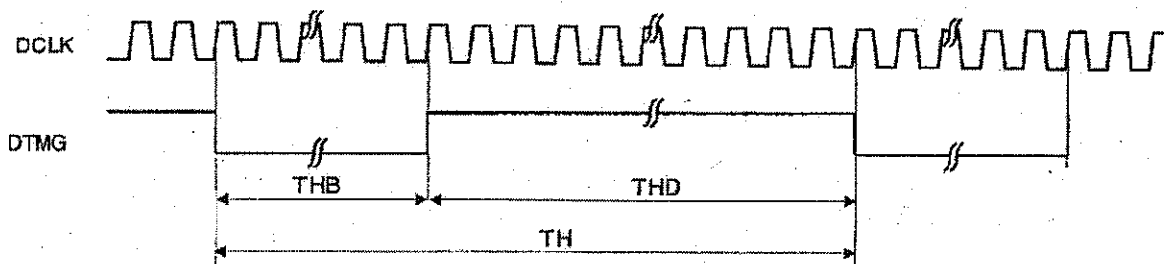

*The DTMG signal for this module is defined as above-mentioned timings for Vsync and Hsync.

This module synchronizes with only DTMG and don't require inputting Vsync and Hsync signals.

During Blanking priod , DTMG should be "Low" level

9.2 INTERFACE TIMING SPECIFICATIONS

Item		Symbol	Min.	Typ.	Max.	Unit	Note
DCLK	Period	TCIP	25	30	33	ns	-
	Width-Low	TCL	12	-	-		
	Width-Hi	TCH	12	-	-		
	Duty	D	0.45	0.5	0.55	-	D= TCi/TCIP
	Rise time	TRCLK	-	-	12	ns	-
	Fall time	TFCLK	-	-	12		
DATA	Setup time	TDSH/TDSL	5	-	-	ns	-
	Hold time	TDHH/TDHL	10	-	-	ns	-
	Rise time	TRDA	-	-	12		
	Fall time	TFDA	-	-	12		
DTMG	Setup time	TES	5	-	-	ns	-
	Hold time	THE	5	-	-	TH	-
	Period	TV	515	525	610		
	Vertical Front porch	TVD	480				
	Vertical Back porch	TVB	35	45	130	DCLK	-
	Period	TH	944	1056	1088		
	Horizontal Front porch	THD	800				
	Horizontal Back porch	THB	144	256	288		
	Rise time	TRDT	-	-	12	ns	-
	Fall time	TFDT	-	-	12		

*Vsync period should be set to odd.

9.3 TIMING BETWEEN INTERFACE SIGNAL AND POWER SUPPLY

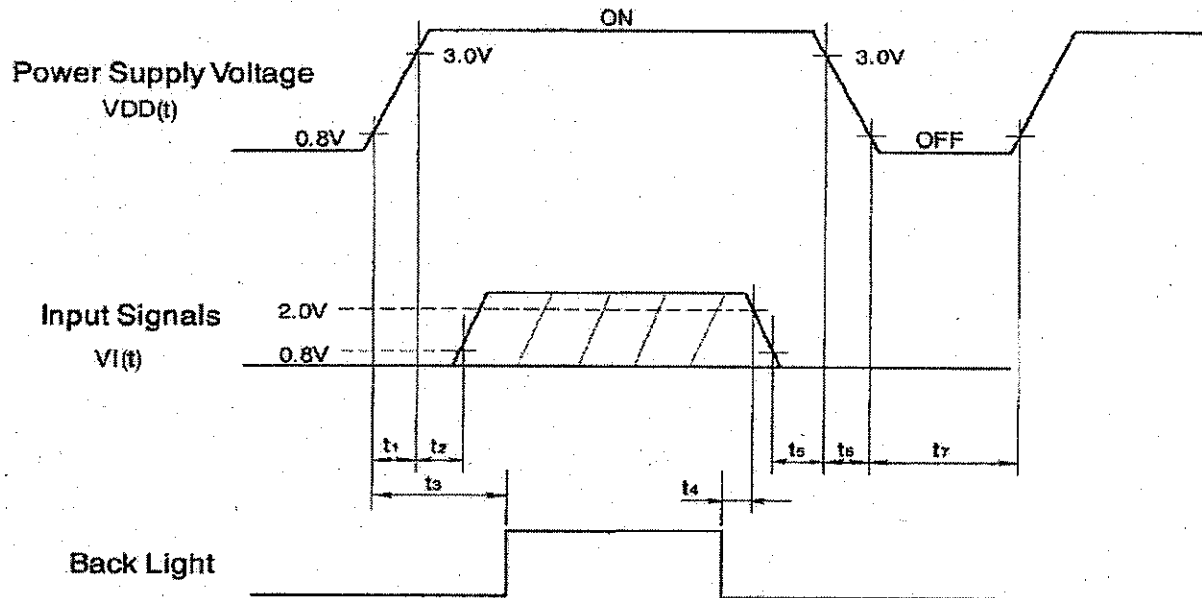

POWER ON

$$t_1 \leq 15\text{ms}$$

$$0\text{ms} < t_2 \leq 45\text{ms}$$

$$0.1\text{s} \leq t_3$$

POWER OFF

$$5\text{ms} \leq t_4$$

$$0\text{ms} \leq t_5 \leq 45\text{ms}$$

$$0\text{ms} \leq t_6 \leq 20\text{ms}$$

$$0.4\text{s} \leq t_r$$

Note 1) Set $0\text{V} \leq V_I(t) \leq V_{DD}(t)$.

Here, $V_I(t)$, $V_{DD}(t)$ indicate the transitional state of V_I , V_{DD} when power supply is turned ON or OFF.

2) Do not keep interface signal high-impedance when power on.

10. DIMENSIONAL OUTLINE

10.1 SURFACE SIDE

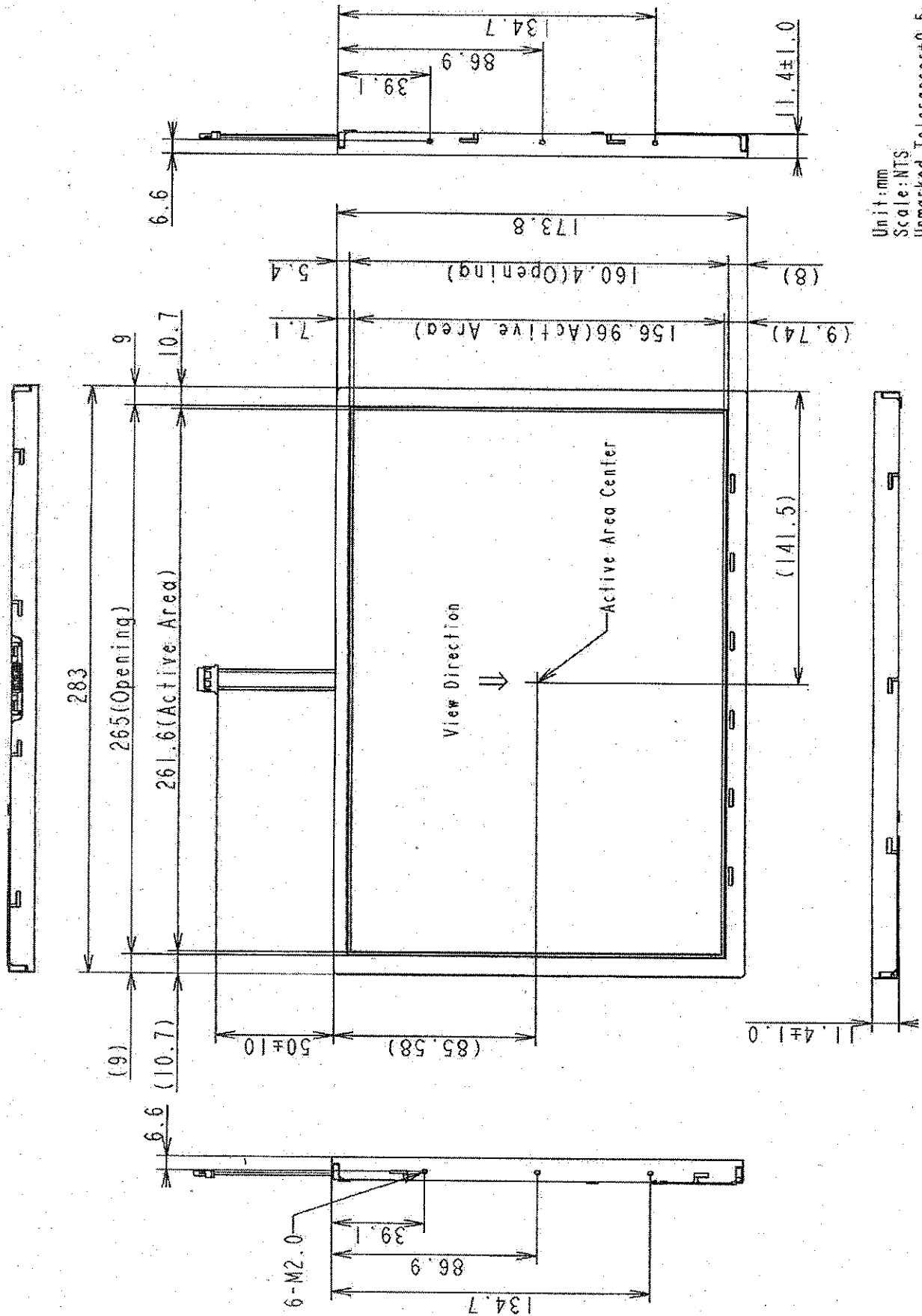

Unit:mm
Scale:NTS
Unmarked Tolerances±0.5

10.2 BACK SIDE

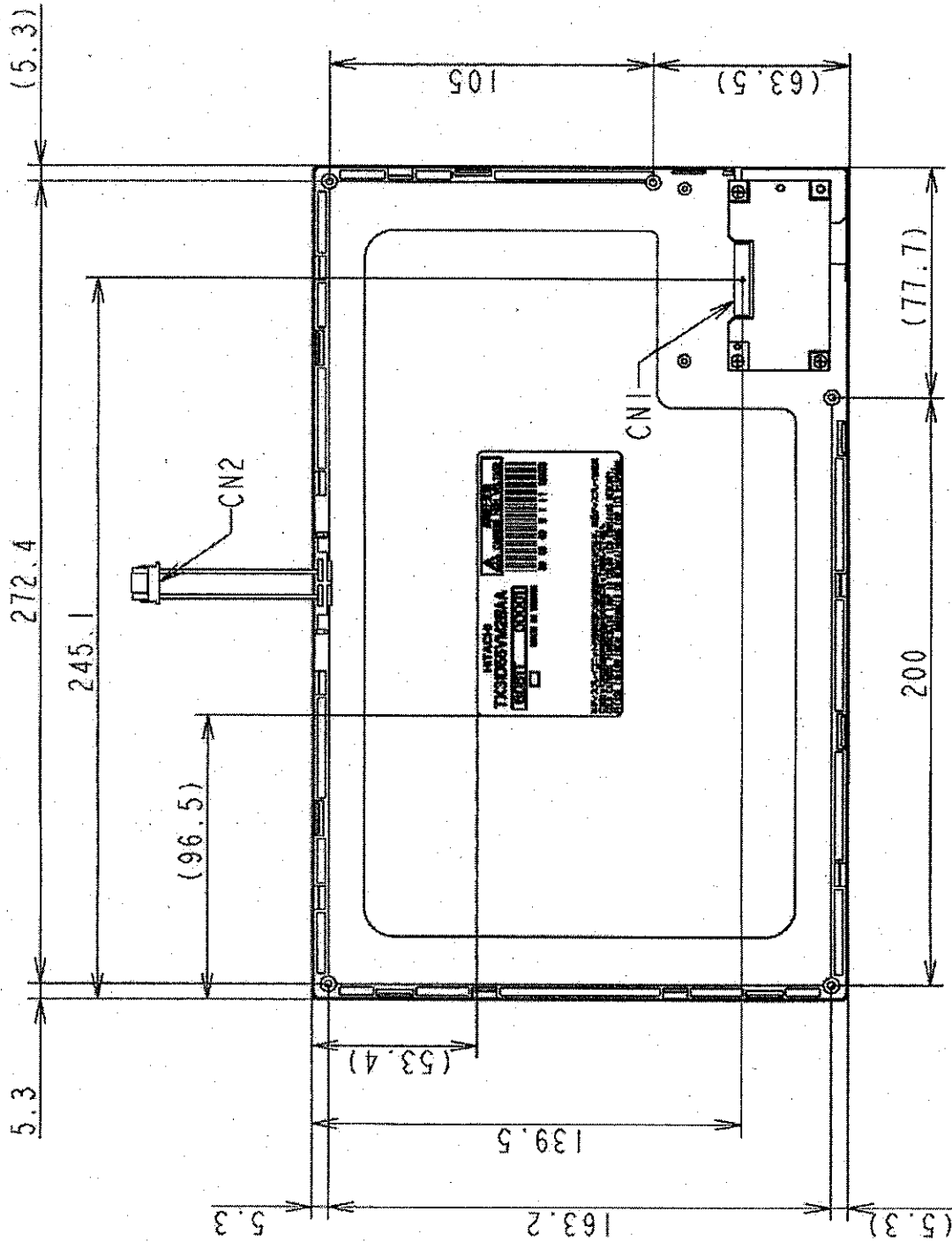

Unit : mm

Note 1) CN1 : FA5B040HP1R3000(JAE) 「Gilding」 CN2 : BHR-02(8.0)VS-IN(JST)

2) Tolerance not specified is ± 0.5 mm

3) Dimensions in parentheses are reference value

11. DESIGNATION OF LOT MARK

11.1 LOT MARK

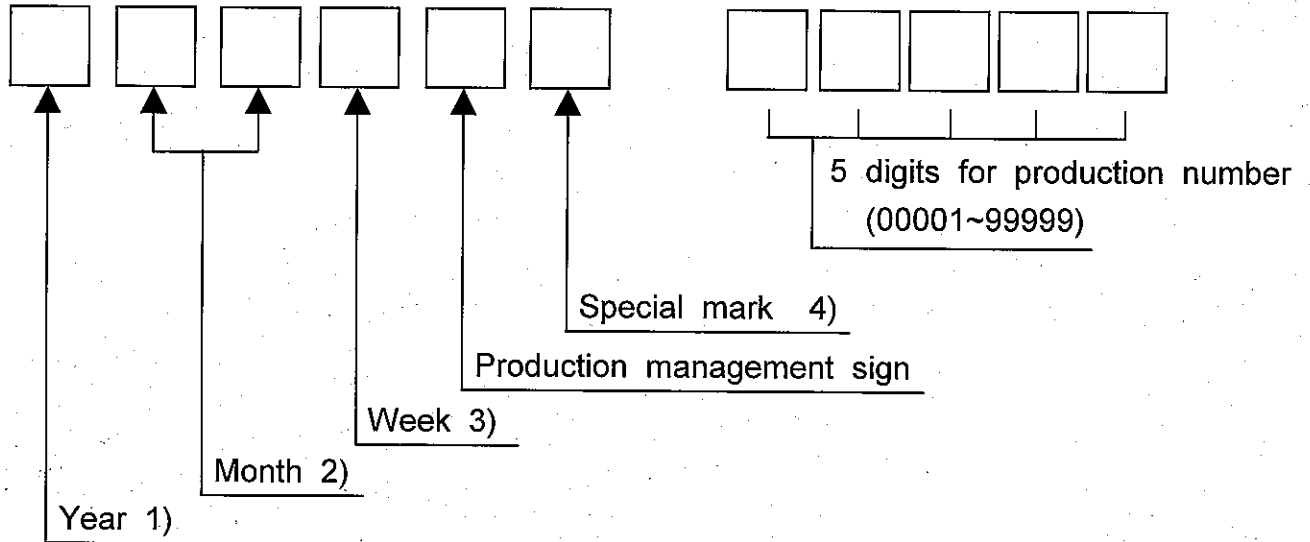

Notes

1)

Year	Mark
2006	6
2007	7
2008	8
2009	9
2010	0

2)

Month	Mark	Month	Mark
1	01	7	07
2	02	8	08
3	03	9	09
4	04	10	10
5	05	11	11
6	06	12	12

3)

Week (Days)	Mark
1~7	1
8~14	2
15~21	3
22~28	4
29~31	5

4) The special mark may be added by manufacturing accordingly to production number.

11.2 REVISION(REV.) CONTROL

REV. column is controlled by the manufacturing. A-Z except I and O is to be written on this column

11.3 LOCATION OF LOT MARK

Lot mark is printed on a label. The label is on rear side of module as shown in the drawing at Section 10.

The style of character may be changed without notice.

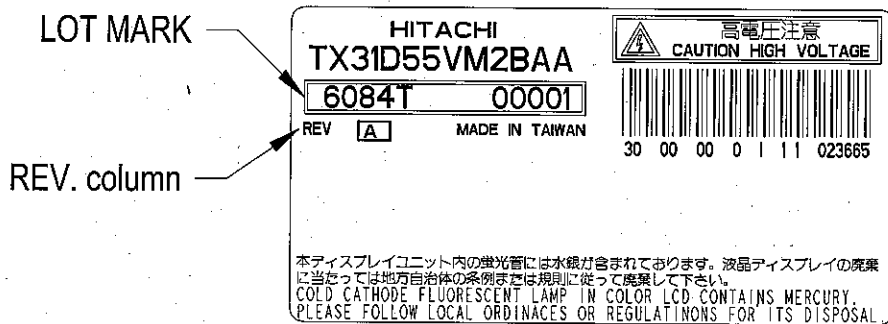

12. COSMETIC SPECIFICATIONS

12.1 CONDITION FOR COSMETIC INSPECTION

(1) Viewing zone

a) The figure shows the correspondence between eyes (of inspector) and TFT-LCD module.

$\theta \leq 45^\circ$: when non-operating inspection

$\theta \leq 5^\circ$: when operating inspection

b) Inspection should be executed only from front side and only A-zone.

Cosmetic of B-zone and C-zone are ignored.

(refer to 12.2 Definition of zone)

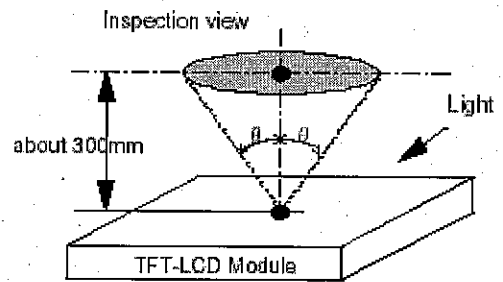

(2) Environmental

a) Temperature : 25°C

The appearance inspection at Back-light on is done at 25°C on a TFT-LCD panel.

b) Ambient light : More than 2000 [lx] and non-directive.

c) Back-light : when non-operating inspection , Back-light should be off.

(3) Operating inspection

Operating inspection should be done with 8 color mode (without gray scale).

12.2 DEFINITION OF ZONE

A-zone : Display area (pixel area)

B-zone : Area between A-zone and C-zone

C-zone : Metallic bezel area (include I/F connector)

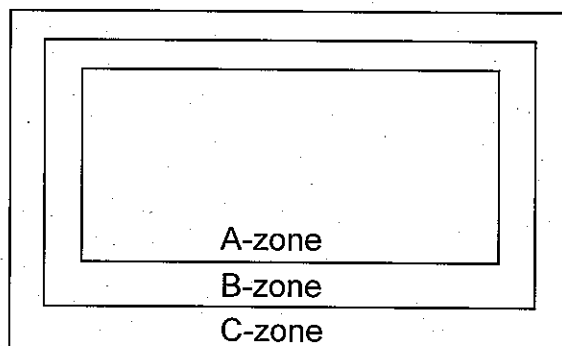

12.3 COSMETIC SPECIFICATIONS

When displaying conditions are not stable (ex. at turn on or off), the following specifications are not applied.

No	ITEM			Max. acceptable number	Unit	Note
				A-zone		
1	Dot defect	Sparkle mode	1-dot	4	pcs	1),2),4)
			2-dots	1	Units	1),2),5)
			3-dots	0		
			4-dots	0		
			Density	2	pcs/φ20mm	1),2),6)
			Total	5	pcs	1),2)
		Black mode	1-dot	5	pcs	1),3),4)
			2-dots	2	Units	1),3),5)
			3-dots	0		
			4-dots	0		
			Density	3	pcs/φ20mm	1),3),6)
			Total	5	pcs	1),3)
		Total			10	pcs
2	Line defect			Serious one is not allowed		-
3	Uneven brightness					
4	Stains, Foreign Materials Line shape W : width (mm) L : length (mm)	W ≤ 0.06	L : Ignore	Ignore	pcs	7)
		W > 0.06	L ≤ 1.0	Ignore		
			L ≤ 1.0	(See dot shape)		
5	Stains, Foreign Materials Dot shape D : ave. dia (mm)	D ≤ 0.45		Ignore	pcs	7)
		D ≤ 0.7		5		
		D > 0.7		0		
6	Scratch on polarizer Line shape W : width (mm) L : length (mm)	W ≤ 0.01	L : Ignore	Ignore	pcs	8)
		W ≤ 0.02	L ≤ 40	10		
			L > 40	0		
		W ≤ 0.04	L ≤ 20	10		
			L > 20	0		
7	Scratch on polarizer Dot shape D : ave. dia (mm)	D ≤ 0.45		Ignore	pcs	8)
		D ≤ 0.7		10		
		D > 0.7		0		

No	ITEM		Max. acceptable number	Unit	Note
			A-zone		
8	Bubbles, peeling In polarizer [D:ave.dia(mm)]	D ≤ 0.3	Ignore	pcs	8)
		D ≤ 0.5	10		
		D ≤ 1.0	5		
		D > 1.0	0		
9	Not Acceptable Wrinkles on polarizer		Serious one is not allowed	-	-

Note 1) Dot defect : defect area > 1/2 dot

2) Sparkle mode : brightness of dot is more than 30% at black raster. (visible to eye)

3) Black mode : brightness of dot is less than 70% at white raster. (visible to eye)

4) 1 dot : defect dot is isolated, not attached to other defect dot.

5) N dots : N defect dots are consecutive. (N means the number of defects dots)

6) Density : number of defect dots inside 20mm ϕ .

7) Those stains which can be wiped out easily are not defects.

8) Polarizer area inside of B-zone is not applied.

13. PRECAUTION

Please pay attention to the followings when you use this TFT-LCD Module with Back-light unit.

Life support applications : HITACHI's products are not authorized for use in life support systems.

13.1 PRECAUTION TO HANDLING AND MOUNTING

- (1) You should consider the mouting structure so that uneven force (ex. twisted stress) is not applied to the module.
- (2) To improve the strength of module against the mechanical shock the space between the module and the case should be less than 1.0mm.
- (3) Protection material in front of LCD's screen surface is recommended to protect a polarizer , LCD-glass and metal bezel. Please be note that the protection material should not touch them directry.
- (4) Acetic acid type and chloline type materials for the cover case are not desiable because the former generate corrosive gas of attacking the polarizer at high temperature and the latter causes circuit break by electro-chemical reaction.
- (5) Do not touch, push or rub the exposed polarizers with glass, tweezers or anything harder than HB pencil lead. And please do not rub by dustclothes with chemical treatment. Do not touch the surface of polarizer with bare hand or greasy close. (Some cosmetics are detrimental to the polarizer.)
- (6) When the surface becomes dusty, please wipe gently with absorbent cotton or other soft materials chamois soaked Normal-Hexane. Normal-Hexane is recommended for clearing the adhesives used to attach front/rear polarizers. Do not use acetone, toluene and alcohol because they cause chemical damage to the polarizer.
- (7) Wipe off saliva or water drops as soon as possible. Their long time contact with polarizer cuses deformations and color fading.
- (8) The module should never be opened or modified.
It may cause not to operate properly.
- (9) Metallic bezel of a module should not be handled with bare hand or dirty gloves. Otherwise, color of a metallic frame may become dirty during its storage. It is recommended to use clean soft gloves and clean finger stalls when a module is handled at incoming inspection process and production (assembly) process.
- (10) When you adopt a metallic shield board on backside of TFT-LCD Module, it should not be too close to TFT-LCD Module.
- (11) Do not pull or do not fold the CCFL cable.

13.2 PRECAUTION TO OPERATION

- (1) You should adopt radiation structure to satisfy the temperature specification.
- (2) Optical response time, luminance and chromaticity depend on the temperature of a TFT-LCD module. (At lower temperature it becomes longer.)
- (3) Response time and saturation time of CCFL luminance become longer at lower temperature operation.
- (4) Sudden temperature change may cause dew on and/or in the a module.
Dew males damage to a polarizer and/or electrical contacting portion.
Dew causes fading of displayed quality.
- (5) Fixed patterns displayed on a module for a long time may cause after-image.
It will be recovered soon.
- (6) Please connect the Back-light connector to the inverter circuit directly.
The long cable between CCFL and the inverter may cause the brightness drop of CCFL and may cause the rise of starting lamp voltage(Vs).
- (7) The module should not be connected or removed while a main system works.
- (8) Inserting or pulling I/F connectors causes any truble when power supply and signal datas are on-state. I/F connectors should be inserted and pulled after power supply and signal datas are turned off.

13.3 ELECTROSTATIC DISCHARGE CONTROL

- (1) Since a module consists of a TFT cell and electronic circuits with CMOS-ICs, which are very weak to electrostatic discharge, persons who are handling a module should be grounded through adequate methods such as a list band.
I/F connector pins should not be touched directly with bare hands.
- (2) Protection film for a polarizer on a module should be slowly peeled off so that the electrostatic charge can be minimized.

13.4 PRECAUTION TO STRONG LIGHT EXPOSURE

A module should not be exposed under strong light. Otherwise, characteristics of a polarizer and color filter in a module may be degraded.

13.5 PRECAUTION TO STORAGE

When TFT-LCD Modules are stored for long time, following precautions should be taken care of:

- (1) Modules should be stored in a dark place. It is prohibited to apply sunlight or fluorescent light during storage. Modules should be stored at 0 to 35°C at normal humidity (60%RH or less).
- (2) The surface of polarizers should not come in contact with any other object. It is recommended that modules should be stored in the HITACHI's shipping box.

13.6 PRECAUTION TO HANDLE PROTECTIVE FILM

- (1) When the protective film is peeled off, static electricity is generated between the film and the polarizer. This film should be peeled off slowly and carefully by people who are electrically grounded and with well ion-blown equipment or in such a condition, etc.
- (2) The protective film is attached to the polarizer with a small amount of glue. If some stress is applied to rub the protective film against the polarizer during the time you peel off the film, the glue is apt to remain more on the polarizer. So please carefully peel off the protective film without rubbing it against the polarizer.
- (3) When the module with protective film attached is stored for long time, sometimes there remains a very small amount of glue, still on the polarizer after the protective film is peeled off. Please refrain from storing the module at the high temperature and high humidity for glue is apt to remain in these condition.
- (4) The glue may be taken for the modules failure, but you can remove the glue easily. When the glue remains on the polarizer surface or its vestige is recognized, please wipe them off with absorbent cotton waste or other soft material like chamois soaked with Norm-Hexane.

13.7 SAFETY

- (1) If module is broken, be careful to handle not to injure.
(TFT-LCD and Lamp are made of glass.)
Please wash hands sufficiently when you touch the liquid crystal coming out from broken LCDs.
- (2) As Back-light unit has high voltage circuit internal, do not open the case and do not insert foreign materials in the case.
- (3) The CCFL inverter should be designed to include the function of output shutdown in case the output overcurrent happen due to any backlight trouble.
The shutdown function should be assured to work in abnormal condition at the actual systems.

13.8 ENVIROMENTAL PROTECTION

- (1) This TFT-LCD Module include Cold Cathode Fluorescent Lamp (CCFL). CCFL contains a small amount of mercury. Please follow local ordinance or regulations for disposal.
- (2) Flexible circuits board, printed circuits board and solder used in a module contain small amount of lead (Pb). Please follow local ordinance or regulations for its disposal.

13.9 USE RESTRICTIONS AND LIMITATIONS

- (1) This product is not authorized for use in life support devices or systems, military applications or other applications which pose a significant risk of personal injury.
- (2) In no event shall HITACHI, Ltd. , be liable for any incidental, indirect or consequential damages in connection with the installation or use of this product, even if informed of the possibility thereof in advance. These limitations apply to all causes of action in the aggregate, including without limitation breach of contract, breach of warranty, negligence, strict liability, misrepresentation and other torts.

13.10 OTHERS

- (1) Electrical components which may not affect electrical performance are subjective to change without notice because of their availability.