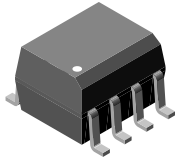
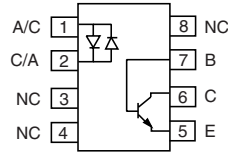


Optocoupler, Phototransistor Output, AC Input, with Base Connection



1179025



DESCRIPTION

The IL256AT is an AC input phototransistor optocoupler. The device consists of two infrared emitters connected in reverse parallel and coupled to a silicon NPN phototransistor detector.

These circuit elements are constructed with a standard SOIC-8 foot print.

The product is well suited for telecom applications such as ring detection or off/on hook status, given its bidirectional LED input and guaranteed current transfer ratio (CTR) minimum of 20 % at $I_F = 10$ mA.

FEATURES

- Guaranteed CTR symmetry, 2:1 maximum
- Bidirectional AC input industry standard SOIC-8 Surface mountable package
- Isolation test voltage, 4000 V_{RMS}
- Standard lead spacing, 0.05"
- Available only on tape and reel (conform to EIA standard RS481A)
- Lead (Pb)-free component
- Component in accordance to RoHS 2002/95/EC and WEEE 2002/96/EC


**RoHS
COMPLIANT**

APPLICATIONS

- Telecom applications ring detection

AGENCY APPROVALS

- UL1577, file no. E52744 system code Y
- CUL - file no. E52744, equivalent to CSA bulletin 5A
- DIN EN 60747-5-2 (VDE 0884) available with option 1

ORDER INFORMATION

PART	REMARKS
IL256AT	CTR > 20 %, tape and reel, SOIC-8

ABSOLUTE MAXIMUM RATINGS

PARAMETER	TEST CONDITION	SYMBOL	VALUE	UNIT
INPUT				
Forward continuous current		I_F	60	mA
Power dissipation		P_{diss}	90	mW
Derate linearly from 25 °C			0.8	mW/°C
OUTPUT				
Collector-emitter breakdown voltage		BV_{CEO}	30	V
Emitter-collector breakdown voltage		BV_{ECO}	5	V
Collector-base breakdown voltage		BV_{CBO}	70	V
Power dissipation		P_{diss}	150	mW
Derate linearly from 25 °C			2.0	mW/°C
COUPLER				
Isolation voltage, input to output		V_{ISO}	4000	V_{RMS}
Total package dissipation (LED and detector)		P_{tot}	240	mW
Derate linearly from 25 °C			3.2	mW/°C
Storage temperature		T_{stg}	- 55 to + 150	°C
Operating temperature		T_{amb}	- 55 to + 100	°C
Soldering time at 260 °C			10	s

Note

$T_{amb} = 25$ °C, unless otherwise specified.

Stresses in excess of the absolute maximum ratings can cause permanent damage to the device. Functional operation of the device is not implied at these or any other conditions in excess of those given in the operational sections of this document. Exposure to absolute maximum ratings for extended periods of the time can adversely affect reliability.

ELECTRICAL CHARACTERISTICS						
PARAMETER	TEST CONDITION	SYMBOL	MIN.	TYP.	MAX.	UNIT
INPUT						
Forward voltage	$I_F = \pm 10 \text{ mA}$	V_F		1.2	1.5	V
OUTPUT						
Collector emitter breakdown voltage	$I_C = 1.0 \text{ mA}$	BV_{CEO}	30	50		V
Emitter collector breakdown voltage	$I_E = 100 \mu\text{A}$	BV_{ECO}	5	10		V
Collector base breakdown voltage	$I_C = 100 \mu\text{A}$	BV_{CBO}	70	90		V
Collector emitter leakage current	$V_{CE} = 10 \text{ V}$	I_{CEO}		5	50	nA
COUPLER						
Saturation voltage, collector emitter	$I_F = 16 \text{ mA}, I_C = 2 \text{ mA}$	V_{CEsat}			0.4	V

Note

$T_{amb} = 25 \text{ }^\circ\text{C}$, unless otherwise specified. Minimum and maximum values are testing requirements. Typical values are characteristics of the device and are the result of engineering evaluation. Typical values are for information only and are not part of the testing requirements.

CURRENT TRANSFER RATIO						
PARAMETER	TEST CONDITION	SYMBOL	MIN.	TYP.	MAX.	UNIT
DC current transfer ratio	$I_F = 10 \text{ mA}, V_{CE} = 5 \text{ V}$	CTR_{DC}	20			%
Symmetry (CTR at + 10 mA)/(CTR at -10 mA)			0.5	1	2	

SAFETY AND INSULATION RATINGS						
PARAMETER	TEST CONDITION	SYMBOL	MIN.	TYP.	MAX.	UNIT
Climatic classification (according to IEC 68 part 1)				55/100/21		
Comparative tracking index		CTI	175		399	
V_{IOTM}			6000			V
V_{IORM}			560			V
PSO					350	mW
ISI					150	mA
TSI					165	$^\circ\text{C}$
Creepage distance			4			mm
Clearance distance			4			mm
Insulation thickness, reinforced rated	per IEC 60950 2.10.5.1		0.2			mm

Note

As per IEC 60747-5-2, §7.4.3.8.1, this optocoupler is suitable for "safe electrical insulation" only within the safety ratings. Compliance with the safety ratings shall be ensured by means of protective circuits.

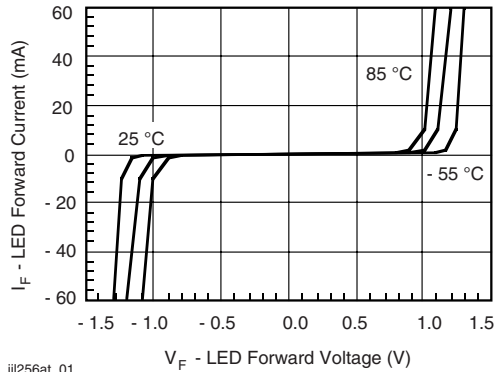
TYPICAL CHARACTERISTICS
 $T_{amb} = 25\text{ }^{\circ}\text{C}$, unless otherwise specified


Fig. 1 - LED Forward Current vs. Forward Voltage

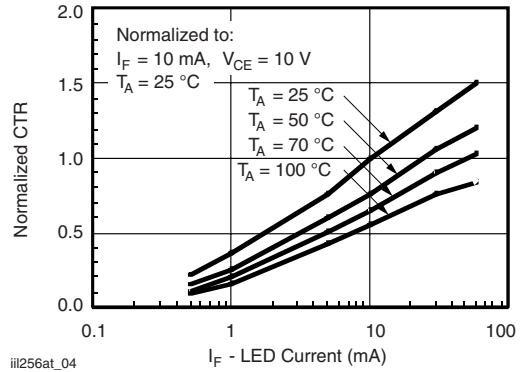
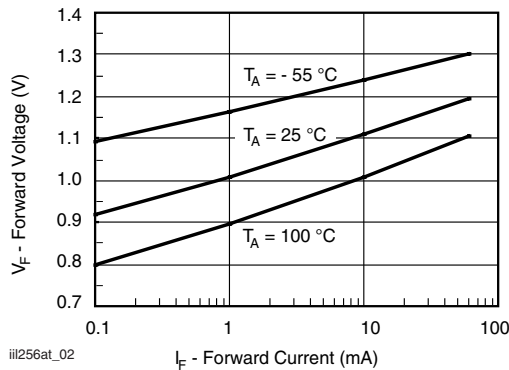

 Fig. 4 - Normalized CTR vs. I_F and T_{amb}


Fig. 2 - Forward Voltage vs. Forward Current

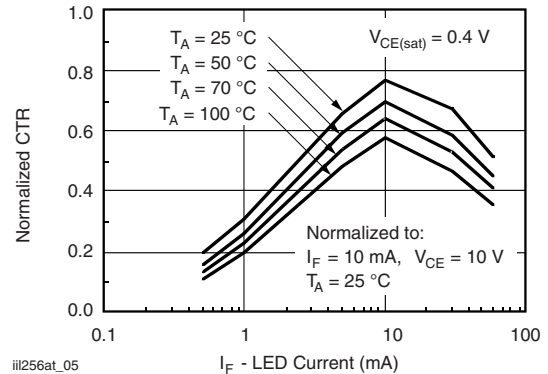


Fig. 5 - Normalized Saturated CTR

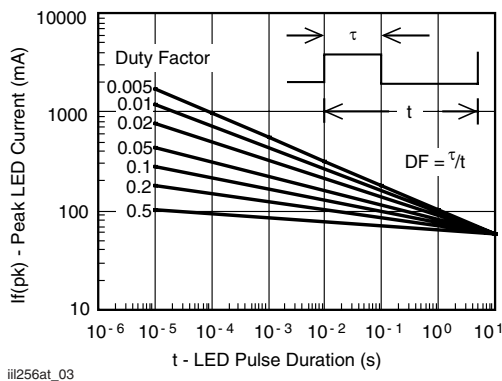
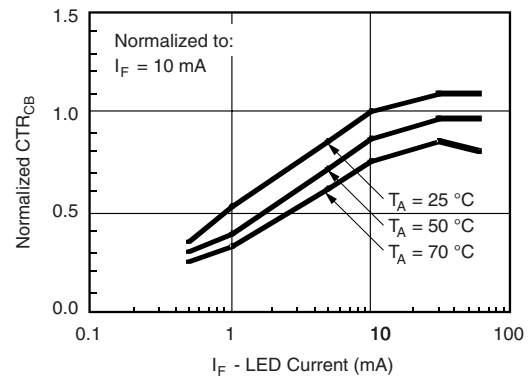
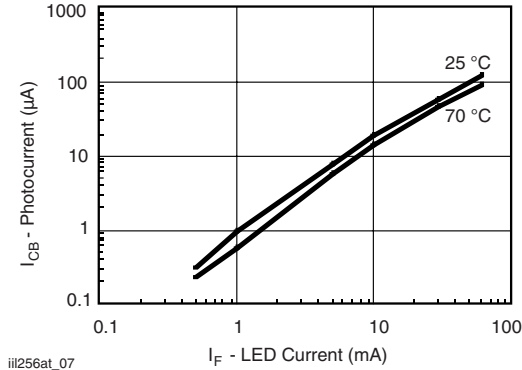


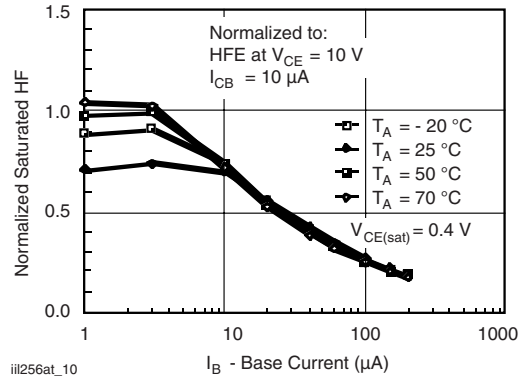
Fig. 3 - Peak LED Current vs. Duty Factor, Tau


 Fig. 6 - Normalized CTR_{cb}



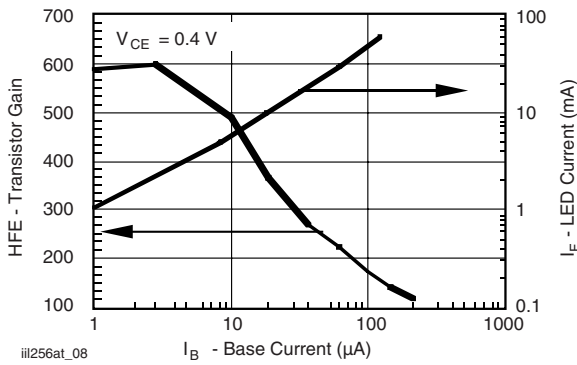
iii256at_07

Fig. 7 - Photocurrent vs. LED Current



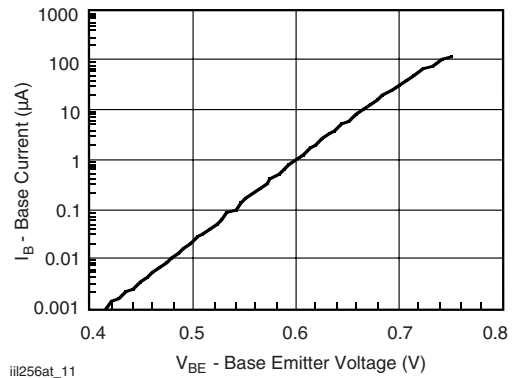
iii256at_10

Fig. 10 - Normalized Saturated h_{FE} vs. Base Current



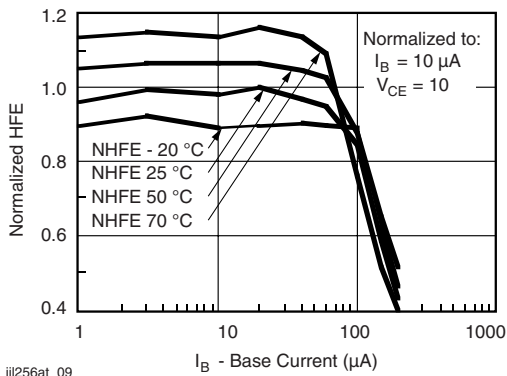
iii256at_08

Fig. 8 - Base Current vs. I_F and h_{FE}



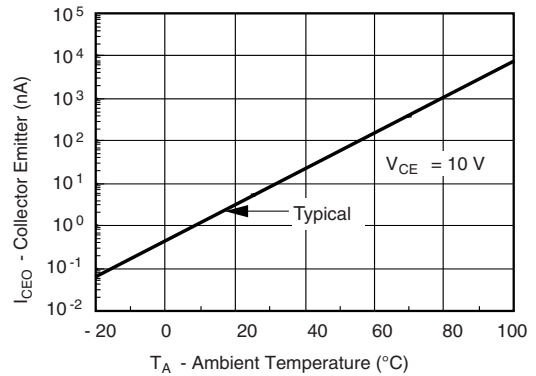
iii256at_11

Fig. 11 - Base Emitter Voltage vs. Base Current



iii256at_09

Fig. 9 - Normalized h_{FE} vs. Base Current and Temp.



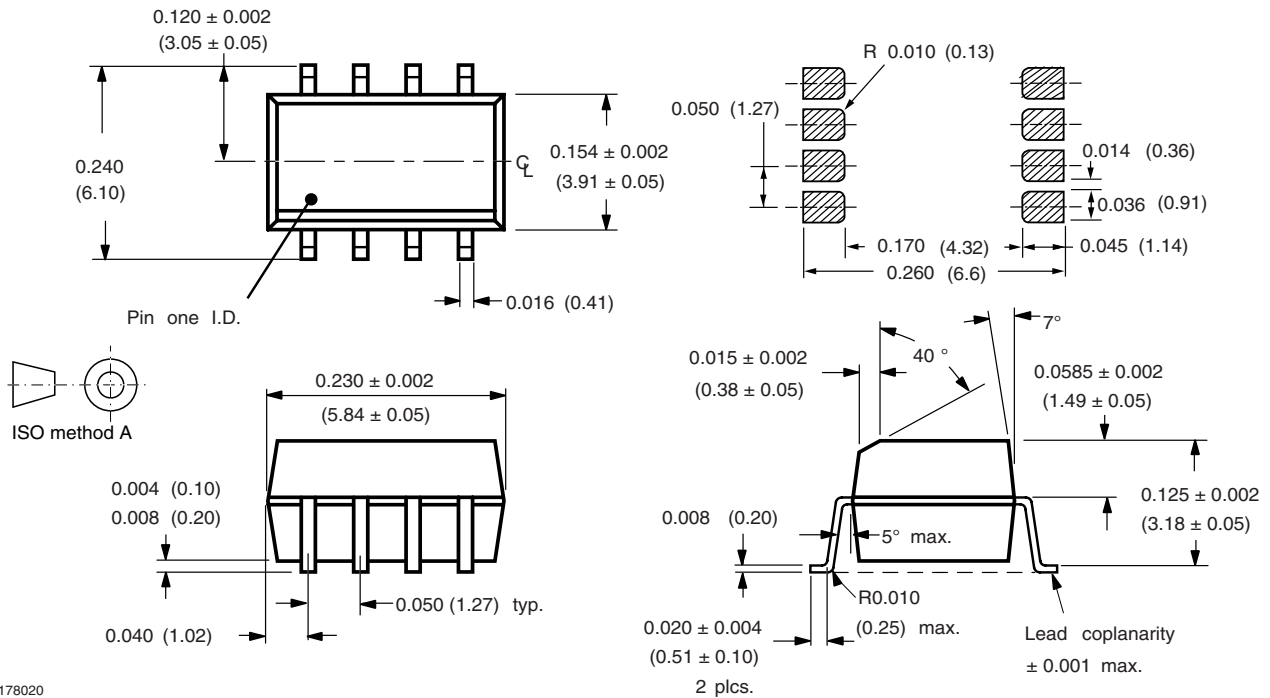
iii256at_12

Fig. 12 - Collector-Emitter Leakage Current vs. Temp.



Optocoupler, Phototransistor Output, Vishay Semiconductors
AC Input, with Base Connection

PACKAGE DIMENSIONS in inches (millimeters)



i178020

OZONE DEPLETING SUBSTANCES POLICY STATEMENT

It is the policy of Vishay Semiconductor GmbH to

1. Meet all present and future national and international statutory requirements.
2. Regularly and continuously improve the performance of our products, processes, distribution and operating systems with respect to their impact on the health and safety of our employees and the public, as well as their impact on the environment.

It is particular concern to control or eliminate releases of those substances into the atmosphere which are known as ozone depleting substances (ODSs).

The Montreal Protocol (1987) and its London Amendments (1990) intend to severely restrict the use of ODSs and forbid their use within the next ten years. Various national and international initiatives are pressing for an earlier ban on these substances.

Vishay Semiconductor GmbH has been able to use its policy of continuous improvements to eliminate the use of ODSs listed in the following documents.

1. Annex A, B and list of transitional substances of the Montreal Protocol and the London Amendments respectively.
2. Class I and II ozone depleting substances in the Clean Air Act Amendments of 1990 by the Environmental Protection Agency (EPA) in the USA.
3. Council Decision 88/540/EEC and 91/690/EEC Annex A, B and C (transitional substances) respectively.

Vishay Semiconductor GmbH can certify that our semiconductors are not manufactured with ozone depleting substances and do not contain such substances.

We reserve the right to make changes to improve technical design
and may do so without further notice.

Parameters can vary in different applications. All operating parameters must be validated for each customer application by the customer. Should the buyer use Vishay Semiconductors products for any unintended or unauthorized application, the buyer shall indemnify Vishay Semiconductors against all claims, costs, damages, and expenses, arising out of, directly or indirectly, any claim of personal damage, injury or death associated with such unintended or unauthorized use.

Vishay Semiconductor GmbH, P.O.B. 3535, D-74025 Heilbronn, Germany



Disclaimer

ALL PRODUCT, PRODUCT SPECIFICATIONS AND DATA ARE SUBJECT TO CHANGE WITHOUT NOTICE TO IMPROVE RELIABILITY, FUNCTION OR DESIGN OR OTHERWISE.

Vishay Intertechnology, Inc., its affiliates, agents, and employees, and all persons acting on its or their behalf (collectively, "Vishay"), disclaim any and all liability for any errors, inaccuracies or incompleteness contained in any datasheet or in any other disclosure relating to any product.

Vishay makes no warranty, representation or guarantee regarding the suitability of the products for any particular purpose or the continuing production of any product. To the maximum extent permitted by applicable law, Vishay disclaims (i) any and all liability arising out of the application or use of any product, (ii) any and all liability, including without limitation special, consequential or incidental damages, and (iii) any and all implied warranties, including warranties of fitness for particular purpose, non-infringement and merchantability.

Statements regarding the suitability of products for certain types of applications are based on Vishay's knowledge of typical requirements that are often placed on Vishay products in generic applications. Such statements are not binding statements about the suitability of products for a particular application. It is the customer's responsibility to validate that a particular product with the properties described in the product specification is suitable for use in a particular application. Parameters provided in datasheets and/or specifications may vary in different applications and performance may vary over time. All operating parameters, including typical parameters, must be validated for each customer application by the customer's technical experts. Product specifications do not expand or otherwise modify Vishay's terms and conditions of purchase, including but not limited to the warranty expressed therein.

Except as expressly indicated in writing, Vishay products are not designed for use in medical, life-saving, or life-sustaining applications or for any other application in which the failure of the Vishay product could result in personal injury or death. Customers using or selling Vishay products not expressly indicated for use in such applications do so at their own risk and agree to fully indemnify and hold Vishay and its distributors harmless from and against any and all claims, liabilities, expenses and damages arising or resulting in connection with such use or sale, including attorneys fees, even if such claim alleges that Vishay or its distributor was negligent regarding the design or manufacture of the part. Please contact authorized Vishay personnel to obtain written terms and conditions regarding products designed for such applications.

No license, express or implied, by estoppel or otherwise, to any intellectual property rights is granted by this document or by any conduct of Vishay. Product names and markings noted herein may be trademarks of their respective owners.

Material Category Policy

Vishay Intertechnology, Inc. hereby certifies that all its products that are identified as RoHS-Compliant fulfill the definitions and restrictions defined under Directive 2011/65/EU of The European Parliament and of the Council of June 8, 2011 on the restriction of the use of certain hazardous substances in electrical and electronic equipment (EEE) - recast, unless otherwise specified as non-compliant.

Please note that some Vishay documentation may still make reference to RoHS Directive 2002/95/EC. We confirm that all the products identified as being compliant to Directive 2002/95/EC conform to Directive 2011/65/EU.