



DATA SHEET
05703 Series

Part of the simpleLED® program

simpleLED 05703 SERIES

The light engine series consist of 4 high power LUXEON Rebel LEDs. It is engineered to provide customers with the flexibility to select the optimal light source for the applications. Customers can modify the simpleLED light source by selecting the LUXEON Rebel LED, optic and connector to best suit their needs.

FEATURES & BENEFITS

- 3 Year Manufacturer (Rena) Warranty
- High-Reliability LED Sources
- Rugged Construction
- Wide Operational Temperature Range
- Multiple Configurable Options
- Flexible Optic Options
- Wide Range Drive Current
- Multiple White CCT's Available
- Short Lead Time
- CE certified, UL recognized

TYPICAL APPLICATIONS

- Under Cabinet Lighting
- Cove Lighting
- Accent Lighting
- Display Case Lighting
- Display Lighting

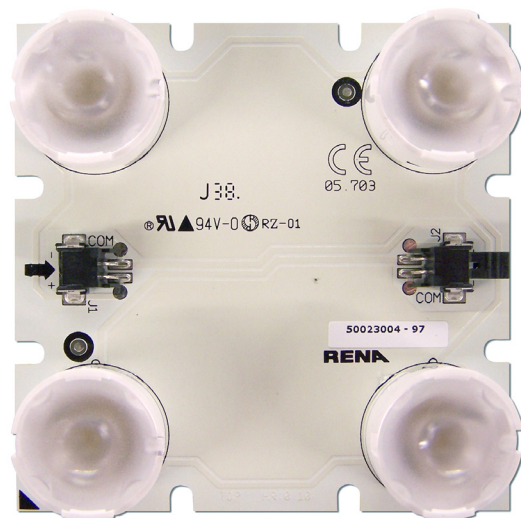
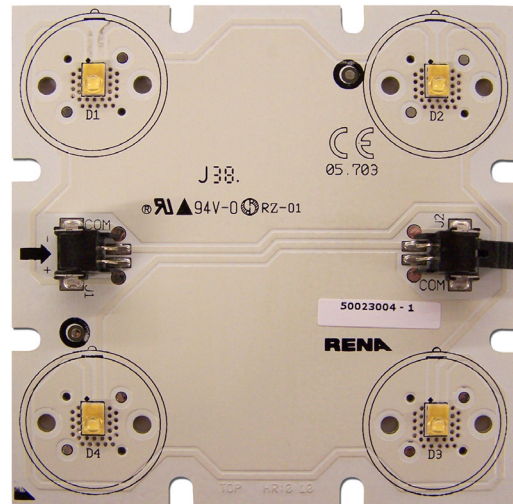

Note: All specifications are subject to change without notice.

MECHANICAL CHARACTERISTICS

PARAMETER	CONDITIONS
PCB	FR-4
Finish	White
Size	75 x 75 mm
Source Type	LUXEON Rebel
Connector	Tyco CT (2-292173-2)
Thermal Resistance (p-n junction to bottom of PCB)	Rth= 21 K/W

ELECTRICAL CHARACTERISTICS

PARAMETER	MIN	NOM	MAX
Forward Voltage (V) @350mA & Tj=25 °C	10.2	12.0	16.0
Power Consumption @350mA (W)	3.6	4.2	5.6

ENVIRONMENTAL CHARACTERISTICS

PARAMETER	MIN	MAX
Storage Temperature (°C)	-40	+70
PCB temperature (°C)	-20	+80

Note: All specifications are subject to change without notice.

THERMAL STATEMENT & ASSEMBLY INSTRUCTIONS

The light engines must operate under proper environmental conditions and the operating ambient air temperature must not exceed a certain maximum which cause the LEDs to exceed the maximum junction temperature as stated in Philips Lumileds datasheet. A heat sink must always be used when operating the light engines. The size of the heat sink depends on the amount of power consumed by the LEDs. The objective is to maintain the junction temperature below the maximum rating in Philips Lumileds datasheet while also not exceeding the maximum PCB temperature.

The light engine must be mounted on a flat heat sink using M3 screws. All screw holes must be used to attach the light engine to the heat sink in order to provide proper heat transfer. Also a thermal conductive interface must be used between the heat sink and light engine. This thermal conductive interface could be a thermal conductive paste such as AmasanT12 from Armack Lottechnik or a thermal interface material such as T-PCM 585 from Laird.

The light engine must not be bent to avoid damaging the LED and/or dislodging the optics. All above specifications must be met in order to qualify for the 3 year warranty.

THERMAL MANAGEMENT

The graphs below show the required thermal resistance of the heat sink based on the maximum operating ambient temperature, the drive current and the maximum allowable PCB temperature. The maximum allowable T_j is a function of the target lifetime of the light engine and the LED current. This information can be found in the Philips Lumileds reliability datasheet RD07.

For example, if the maximum ambient temperature is 35°C and the drive current is 500 mA, the heat sink should have a R_{th} of 5.3 K/W to meet the max PCB temperature requirement. This is shown in figure 1. With the known R_{th} of the heat sink, the delta T from junction to ambient can be determined in figure 2. A R_{th} of 5.3 K/W has a delta T of 68 °C, which means that the LED has a T_j of 103 °C.

With the same graphs the max operating ambient temperature and the junction temperature can also be determined if the thermal resistance of the chosen heat sink is known.

Note; the graphs show that not all combinations of T_j and max ambient are possible.

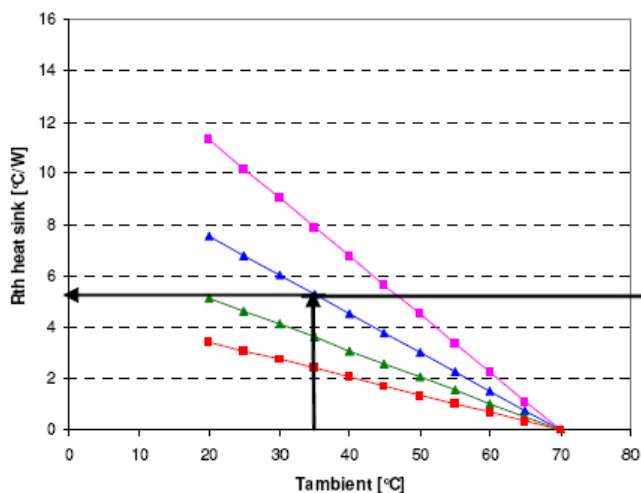

Figure 1

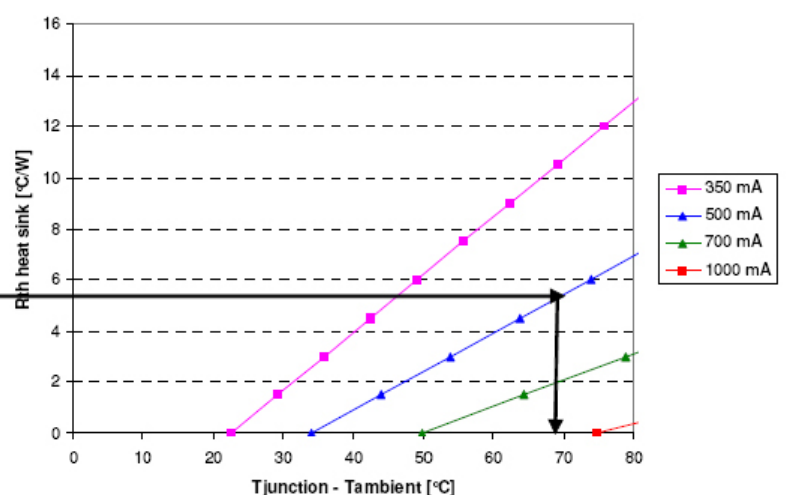
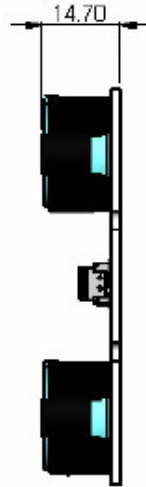
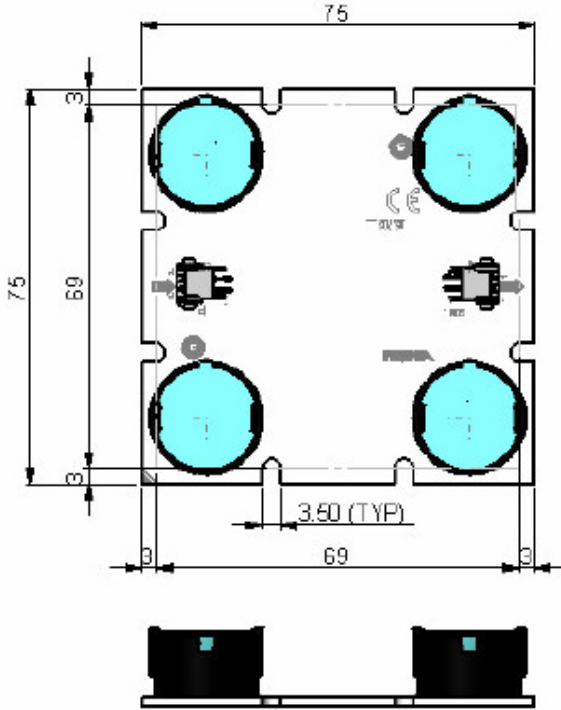

Figure 2

Note: All specifications are subject to change without notice.

MECHANICAL DRAWINGS

2D drawings with dimensions in mm



PCB WITH
20mm OPTIC

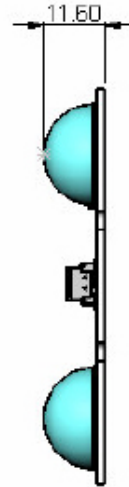

PCB WITH
BUBBLE OPTIC

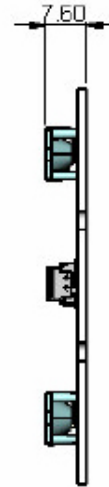

PCB WITH
10mm OPTIC

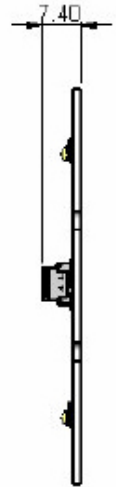

PCB WITHOUT
OPTIC

INTERCONNECTIVITY OPTIONS

Board-to-board wiring options and drawings

Boards connected in series:

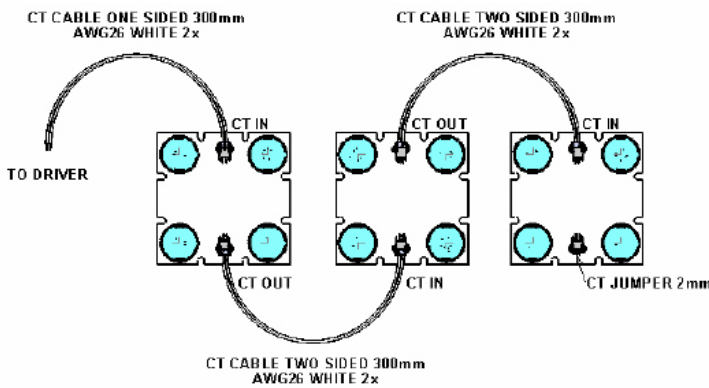

Boards connected in parallel:

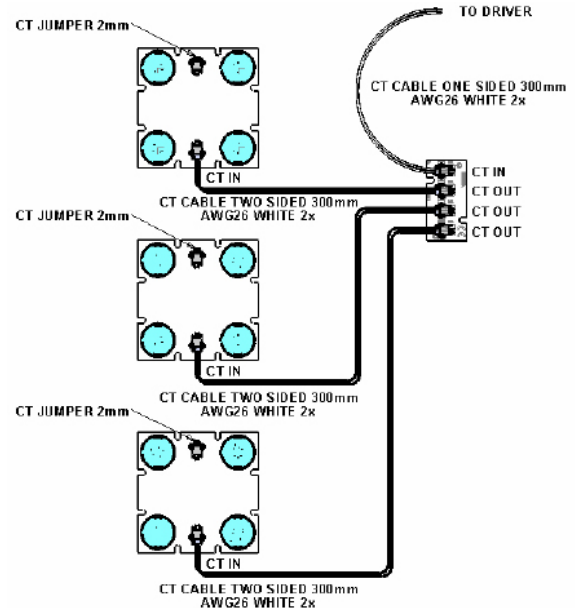

Note: All specifications are subject to change without notice.

ACCESSORIES FOR INTERCONNECTIONS

Cable options for board to board connection and for driver connection
(depending on selected driver)

Part number CT- CT cable	Cable length (mm)	Wire colors
1969343-6	300	white
1969343-5	150	white
1969343-4	50	white
1969343-3	300	red & black
1969343-2	150	red & black
1969343-1	50	red & black

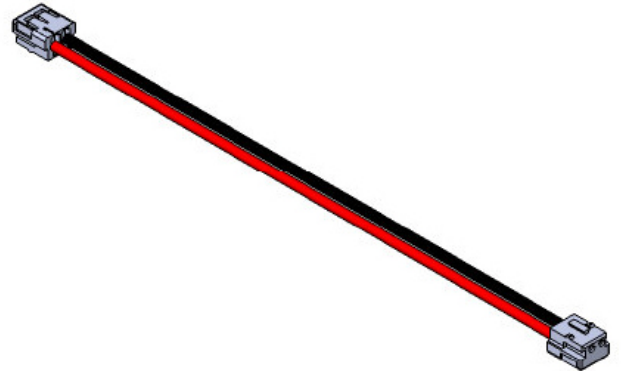

Part number single CT cable	Cable length (mm)	Wire colors
1969336-6	300	white
1969336-5	150	white
1969336-4	50	white
1969336-3	300	red & black
1969336-2	150	red & black
1969336-1	50	red & black

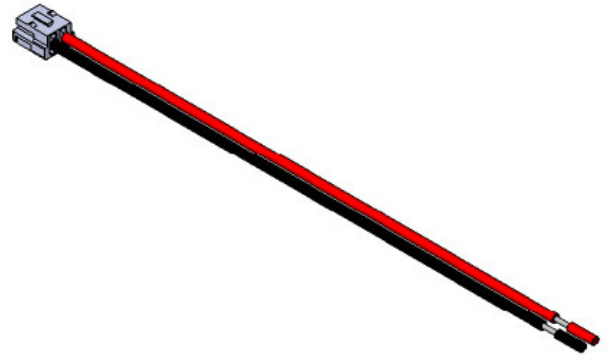

* Please refer to www.FutureLightingSolutions.com for a detailed explanation on choosing the correct cable assembly.

Note: All specifications are subject to change without notice.

ACCESSORIES FOR INTERCONNECTIONS

Interconnection board for parallel assembly
Part number 57011121

2D drawings with dimensions in mm

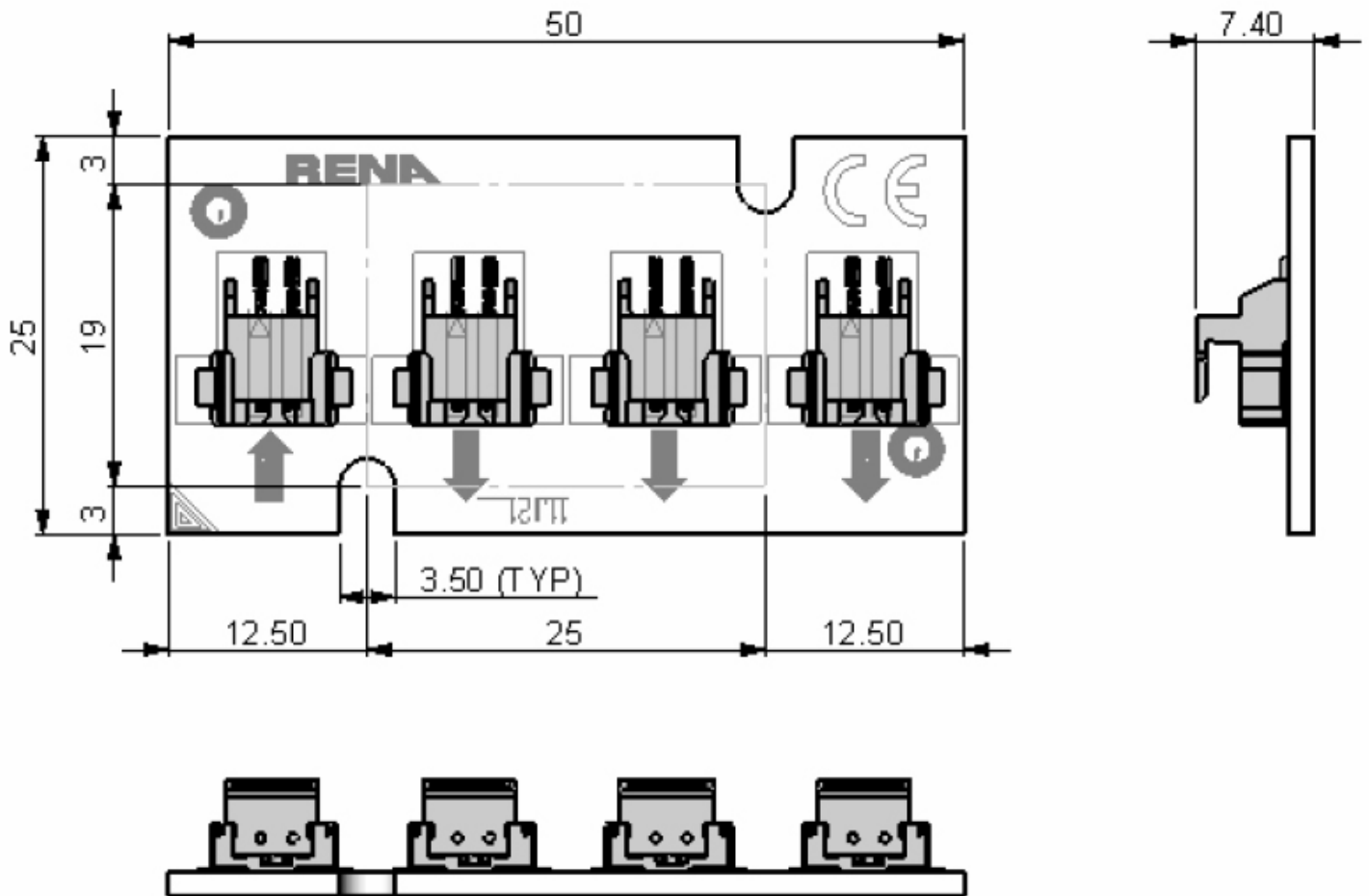

Note: All specifications are subject to change without notice.

PART NUMBERING & ORDERING INFORMATION

1. PRODUCT SERIES (05703)

square board with 4 LEDs in series

2. COLOR TEMP (AAAA)

7777 = Neutral White
8888 = Warm White
9999 = Cool White

3. MINIMUM CRI* (BB)

XX = No Min CRI
55 = Min 55
60 = Min 60
65 = Min 65
70 = Min 70
75 = Min 75
80 = Min 80
85 = Min 85
90 = Min 90

4. MINIMUM FLUX* (LM) (CCC)

065 = Min 65
066 = Min 66
067 = Min 67
075 = Min 75
080 = Min 80
100 = Min 100

1. LED TYPE

R = LUXEON Rebel

5. CONNECTOR (D)

C = Connector
N = No Connector

Part Number:

05703RAAAABBCCCDEFG

1
2
3
4
5
6
7
8

6. SUPPLIER COLLIMATOR (E)

X = No Optics
A = Carclo 10mm
B = Carclo 20mm
D = Carclo bubble

7. OPTIC HOLDER (F)

(Carclo 20mm)
X = No Holder
A = Carclo Single Black Holder 10235
B = Carclo Single White Holder 10236
C = Carclo Single Clear Holder 10237

8. COLLIMATOR (G)

X = No Lens
10 and 20 mm optics:
C = Narrow Beam
D = Narrow Beam Frosted
E = Medium Beam
F = Medium Beam Frosted
G = Wide Beam
H = Wide Beam Frosted
K = Elliptical Beam
L = Elliptical Beam 90°
Bubble optics:
R = Ultra Wide 120°
S = Ultra Wide 130°

* According to Lumileds datasheet
Special configurations available upon request
Contact your local sales representative

Note: All specifications are subject to change without notice.

COMPANY INFORMATION

About Future Lighting Solutions

Future Lighting Solutions (www.futurelightingsolutions.com) is a leading provider of LED lighting components and support services for solid-state lighting products and installations, including engineering expertise, concept development, full system solutions and online tools that accelerate quality application development. The company is a division of Future Electronics.

About simpleLED®

Future Lighting Solutions simpleLED program has over 500 combinations of LUXEON® LED & Optic configurations, enabling you to select the right Light Engine for your application, eliminate prototyping delays and accelerating time to market. Additional benefits include UL recognized quality and a 3 year warranty. Visit our website and start innovating.

CONTACT DETAILS

In North America:
1-888-LUXEON2
Americas@futurelightingsolutions.com

In Europe:
00-800-44FUTURE
Europe@futurelightingsolutions.com

In Asia:
+800-LUMILEDS
Asia@futurelightingsolutions.com

In Japan:
+81-0120-667-013
Japan@futurelightingsolutions.com

Note: All specifications are subject to change without notice. Warranty provided by the manufacturer, Rena Electronica BV.