



Tools ^{That} Work



2006 Catalog

When NASA needed a special hand tool for the International Space Station, they called Bondhus. They needed the very best tool for the most demanding of applications. NASA discovered what millions of professional tool users around the world already know — Bondhus tools work in even the most difficult circumstances.

Bondhus tools are demanded by the most discriminating hand tool users in more than 60 countries all around the world. Bondhus strength and consistency of quality are the standards by which hand tools are judged. Why do tool professionals at NASA and all over the world demand Bondhus tools? Whether they work in space or on an oil rig in the middle of the ocean, the tools they use have to work the first time... they don't have time to go back for a replacement.



PHOTO COURTESY OF NASA JOHNSON SPACE CENTER

Bondhus tools are made in the U.S.A. and are available in more than sixty countries including:

Argentina • Australia • Belarus • Belgium • Brazil • Canada • Chile • China • Costa Rica • Czech Republic • Denmark • England • Finland • France • Germany • Greece • Hong Kong • Hungary • Iceland • India • Israel • Italy • Japan • Jordan • Korea • Luxembourg • Mexico • New Zealand • Netherlands • Norway • Philippines • Poland • Portugal • Puerto Rico • Romania • Russia • Singapore • Slovak Republic • Spain • Sweden • Switzerland • Taiwan • Thailand • Turkey • Vietnam • West Indies

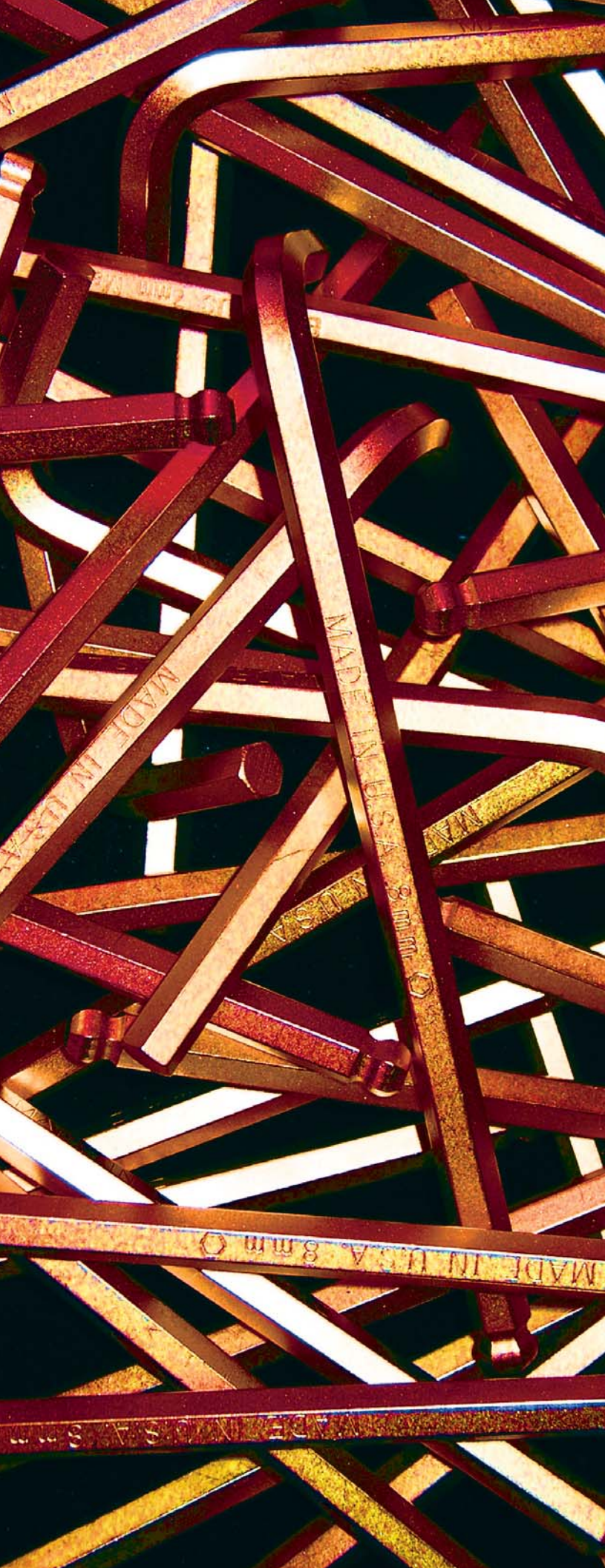

A note from John Bondhus

Prior to founding Bondhus Corporation, I spent many years as a tool and die maker. I have always taken pride in “working in the shop” and I understand and appreciate the value of high quality, long-lasting, time saving tools. I am personally appalled by second rate tools and I will never compromise usability or quality for lower manufacturing costs or gimmick design features. I am not only a tool maker, I’m a tool user, and I will never disappoint my customers by providing anything less than the finest tools available!

John Bondhus

Contents



ProHold® Tip Tools

Introduction12
 Sets13, 15, 19
 Hex keys13, 15, 19,
 20, 25, 26, 33
 Screwdrivers13, 15, 17,
 35-37
 T-Handles13, 15-16,
 43-44

Star Tools

Introduction14
 Sets13, 15
 Wing & Flag16
 Hex keys13, 15, 17,
 20-21, 33
 Screwdrivers13, 15, 17,
 21, 35-37
 Fold ups15, 20, 39
 T-Handles13, 15-16, 43
 BallStar™ Tip15, 17, 21,
 33, 35-36
 ProHold® Tip13, 15-17,
 33, 35, 37

Wing/Flag Tools

Introduction16
 Sets and Singles16

Ball End Tools

Introduction18
 Sets13, 15, 19, 21, 23,
 25, 33, 35, 39, 43
 Hex keys13, 15, 17,
19, 20-21, 23,
25-29, 31-33
 Screwdrivers13, 15, 17,
 21, 35-37, 40-41
 Fold Ups20, 21, 39
 Bits & Blades ...21, 40-41
 T-Handles13, 15, 21,
 43-44
 ProHold® Tip13, 19-20,
 25-26, 35-36, 43-44
 Stubby23, 27, 29
 BallStar™ Tip ...15, 17, 21,
 33, 35, 37

Stubby Tools

Introduction22
 Sets19, 20, 23, 25
 Hex keys23, 25,
 27, 29

thirteen
unique tips

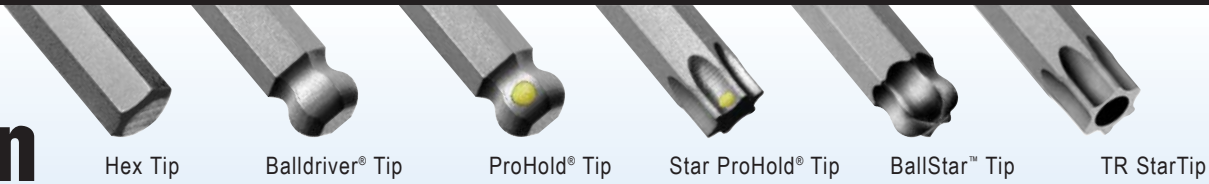

the
right
tool for the
job

seven
handle types





Hex Keys



Screwdrivers



Fold Ups



Bits & Blades



T-Handles

Introduction24
 Sets13, 15, 19–21,
 23, 25, 33
 Hex20, 25–30, 32
 Ball Hex13, 19–20, 23,
 25–29, 31–32
 Stubby19–20, 23, 25,
 27, 29
 ProHold® Tip13, 15–17,
 19–20, 25–26,
 33, 35–37
 Star13, 15–17, 21, 33
 BallStar™ Tip13, 15, 17,
 21, 33

Introduction34
 Sets13, 15, 35
 Ball Hex13, 21, 35–37
 Star13, 15, 17, 21,
 35–37
 Square Ball35–36
 ProHold® Tip13, 15–17,
 35–37
 BallStar™ Tip15, 17, 21

Introduction38
 Sets39
 Hex20, 39
 Ball Hex21, 39
 Star15, 20, 39
 Utility39

Introduction40
 Sets and Singles21,
 40–41

Introduction42
 Sets43–44
 Hex43–44
 Ball Hex13, 21, 43–44
 ProHold® Tip13, 15–16,
 43–44
 Star13, 15–16, 43

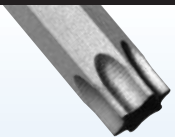

StarTip

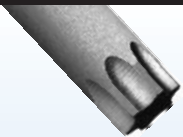

Star Plus Tip

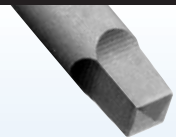

Square Tip



Square Ball Tip

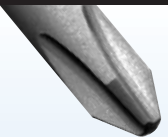

Phillips Tip



Slotted Tip



Awl Tip

five
hex key styles



three
types of protection



three
blade/bit types



- **ProGuard** : The Ultimate in corrosion protection
DRY SURFACE TECHNOLOGY DST
- **BriteGuard** : Next generation chrome finish
FINISH
- **GoldGuard** : Real 14 karat gold finish
FINISH

BONDHUS Timesaving GorillaProof Tools



Protanium® High Torque Steel is much more than "just steel" and much more than a "name". It is a specification, a process and a commitment to producing a level of tool performance unmatched by any competitor.

Protanium® high torque steel is not an 8650 grade steel, it is not a form of S2 and it is not a chrome-vanadium or chrome-moly type steel. It is custom mixed to a formula that is the result of many years of research and continuous development effort.

Bondhus works extensively with its' steel suppliers to ensure meticulous quality control, testing and documentation standards are adhered to. Conformance to Bondhus' specification means qualified technicians perform constant inspection, testing and evaluation steps to make sure the "no compromises" quality policy is always enforced. Over 60 separate tests guarantee that every tool manufactured is 100% within spec.

Customized heat treating processes are key to bringing out the superior strength properties of Protanium® high torque steel. Anyone with a piece of steel and a torch can perform some level of heat treating. Attaining results that push beyond industry accepted limits of performance requires equipment, skill, and years of research and development that Bondhus alone has committed itself to.

Hex stock must be smooth and free of pits, burrs, and other imperfections. Bondhus demands 100% compliance from mills that supply steel.

Sharp edges are critical to the tool fitting properly in a fastener. Rounded corners are not accepted. They will cause slippage and failure. Bondhus maintains the toughest standards in the industry.

Grain size is monitored before and after heat treating. A small grain size helps assure conformance to strength and hardness standards.

4mm Tools — Average Stock Torque (in-lb)

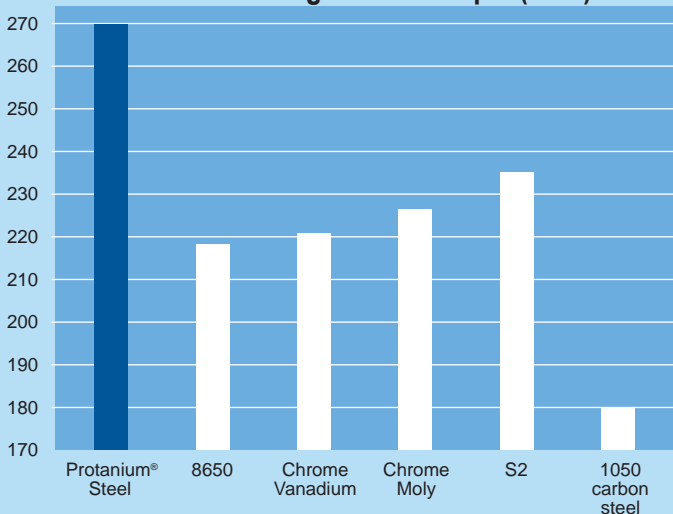

Custom mixed steel and precise control of the heat treating process are two keys to producing the strongest hex and star tools in the world.

Average Torque (in-lb)

Hardness Rockwell C	Tensile Strength PSI	5/64"	1/8"	5/32"	1/4"	5/16"	
		& 2mm		& 4mm		& 8mm	
61	360000	34	141	273	1125	2187	
59	340000	32	133	258	1063	2065	Protanium® Steel
57	320000	30	125	243	1000	1944	
55	300000	28	117	228	938	1822	
53	280000	27	109	213	875	1701	8650 Steel
51	260000	25	102	197	813	1579	
49	240000	23	94	182	750	1458	
46	220000	21	86	167	688	1336	Carbon Steel
43	200000	19	78	152	625	1215	
40	180000	17	70	137	563	1093	
37	160000	15	63	121	500	972	

Note

If hardness and good ductility are maintained, then the higher the tensile strength, the stronger the tool.

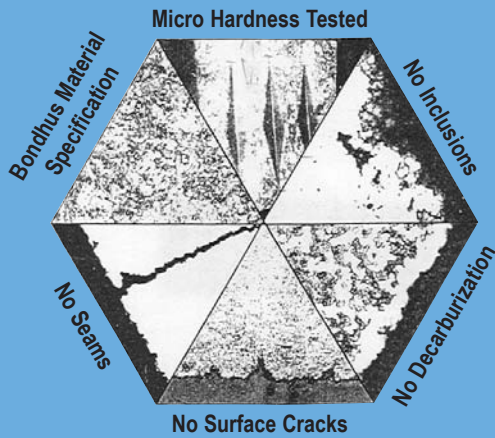

Cracks, decarburization, seams, surface discontinuities, undissolved carbides, and inclusions are not unusual in common grades of steel. These conditions cause poor ductility and premature tool breakage. The Protanium® steel specification, however, does not allow for these conditions to exist.

Hardness and Ductility
Protanium® Steel is considerably harder than the steel produced by most Bondhus competitors. When competitors do have hardness values approaching that of Protanium® steel, they do so by sacrificing ductility.

Ductility is important to monitor, since as the hardness increases, so does brittleness and the potential for shattering. Every batch of Protanium® steel is tested by applying torque in a standard break test.

The Bondhus standard assures in excess of 99% of all breaks will actually break clean and straight. Most competitors cannot even hit 50% clean breaks. Tools that shatter are a hazard to both the user and equipment in the vicinity.

Hardness testing is performed during and after the heat treating process to accurately measure and constantly monitor hardness values.

Bondhus strives for consistent hardness throughout, not just on the surface. Micro hardness testing is performed beneath a microscope on polished cross sections encased in epoxy. Too much hardness causes brittleness; not enough causes premature wear.

Torsional tensile strength is monitored for every batch of steel. An ongoing effort is made to improve strength and reduce or eliminate shattering. The heat treating process is adjusted for every batch of steel to obtain maximum ductility and hardness.

Extensive lab testing has proven that Bondhus tools consistently generate up to 20% more torque than any other manufacturer in the industry. Independent lab testing results are available within the **Tech Library section at www.bondhus.com**.

Inferior Tools are Expensive

Time is money, and the real cost of using an inferior tool is realized when something goes wrong. As anyone who works with mechanical devices knows, bad things occasionally happen. It's not a question of "if", but rather "when".



Stripped screw heads are one of those bad things that happen. A stripped screw head can no longer be removed with a hex tool. If it's in a difficult to reach location, where a clamping device cannot grip it, the task becomes particularly problematic.

The cost of a high quality hex tool is negligible compared to the cost of removing a broken or stripped screw. Will the removal take a few hours? An entire day? What is the real cost of an inexpensive, poorly performing hex tool?

Bondhus quality hex tools are made from Protanium® high torque steel and have sharper corners to generate maximum holding and turning forces within the screw to virtually eliminate stripped screw heads.

Professional hex tools deliver a level of performance not attainable by consumer grade tools. In addition, safety is a factor that can impact the "actual" cost of ownership. As a result, knowledgeable buyers and professionals alike recognize the serious dangers of inferior tools that shatter instead of breaking clean.

The purpose of a high quality tool is to provide a faster, easier, and less costly means of performing a task. Bondhus strives to provide not just "good" tools, but the finest tools available anywhere. Customer satisfaction is what we strive for.



BONDHUS Timesaving GorillaProof Tools

Why a Bondhus Ball End Tool?

A ball end tip is a tremendous time saver. It allows a tool to be inserted into a screw head quickly, even from an angle or when working in the blind.

The concept by which the ball end tip slides into a screw head is known as funnel insertion. The side of the ball end directs or funnels the tool into the screw head, and precise machining ensures an exact fit between tool and screw head.

Bondhus is not a “me too” manufacturer of ball end tools; Bondhus invented the hex ball end and for almost forty years has been continually improving on this invention. Bondhus ball end tools sell better than the competition because they work better and last longer than competitor tools. It’s that simple. Bondhus ball end tools significantly reduce the amount of time it takes to complete a task.

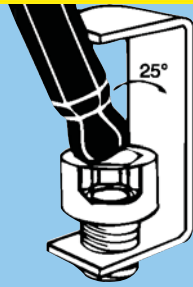

Angle entry to 25°

- Works in hard to reach areas
- Faster insertion and removal
- Precisely machined tip “funnels” itself into screw head



Ergonomic design

- Allow natural hand and wrist rotation
- Turns a full 360° in location
- Reduces user fatigue

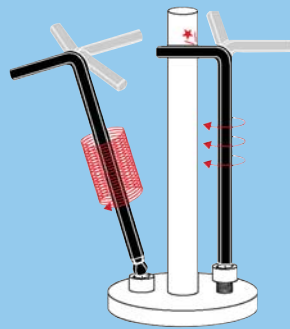

Efficient design

- Works even in blind locations or near obstructions
- Eliminates need to continuously remove, reposition, and reinsert tool
- Engages to full depth
- Reduces ‘stripping’ problems

Bondhex™ Cases

Thirty years ago, Bondhus introduced the first molded case for organizing hex keys.

- **Color coded for easy identification:**
Inch (yellow)
Metric (red)
Star (green)
- **Convenient storage holds tools firmly in place**



- Organizes hex tools in a compact manner
- Sorts and prevents loose or lost hex keys
- A slight twist of the wrist releases tools from their locked position

GorillaGrip® Folding Tools

Bondhus developed the molded handle that revolutionized the concept of fold up tools.

- Handle fits comfortably in a users hand
- Does not conduct heat or cold
- 40% stronger than comparable steel handles
- Time saving blade selection
 - Special flutes separate tools
 - Flutes allow quick selection of one blade at a time
 - Eliminates annoyance of having to constantly unstack blades to make a selection
- Eight different tips available
 - Color coded handles for easy identification: Inch (yellow), Metric (red), Star (green).
 - Turn & flip feature eliminates constant repositioning of tool when working near obstructions
- 90° stop feature converts the GorillaGrip® folding tool into a time saving speed wrench

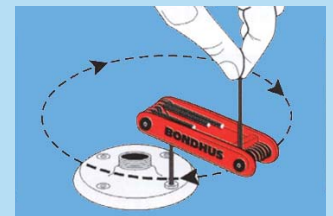
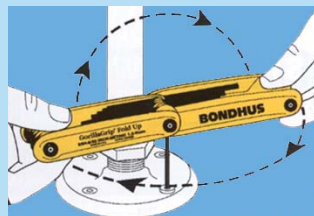

Stubby tools

Bondhus was the first U.S. manufacturer to introduce a complete line of short arm hex key tools for applications where a standard hex key cannot reach.

- Reach into low clearance areas and turn a screw
- No need to ever cut down and file a standard wrench again as a makeshift solution
- Tighter short arm radius than a standard hex key
- Short arm has hex tip, and long arm has a ball end tip for maximum time savings



ProHold® Tip Screw Holding Technology

Bondhus is the developer and exclusive manufacturer of patented ProHold® tip tools — the best screw holding technology available.

- Holds screws tight on the tool every time
- Available for both hex and star tools
- Bondhus is the only manufacturer making screw holding tools in sizes as small as .050" and 1.27mm
- Smooth tool rotation is preserved
- Does not reduce the strength of the tool or cause damage to the screw head
- Non-magnetic
- Never drop a screw again
- Available in a full range of Hex and Star sizes: .050" to 3/8", 1.27mm to 10mm, and T9 to T60

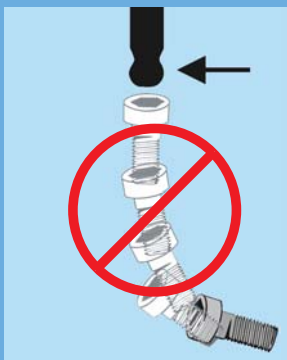

Handles Designed for Productivity

Ergonomically Shaped T-handles

Bondhus is the only U.S. manufacturer to design and build T-handles that fit the shape of a users hand.



- Mass of the full metal handle generates a flywheel effect for rapid insertion or removal of screws
- Tough coating resists damage and cushions grip
- Handle does not attract or hold dirt — excellent cleanup qualities
- Slight curve eliminates painful problem of handles digging into hands
- Handle welded directly to blade - eliminates loosening and wobbling of blade due to wear
- Focuses effort on turning a screw, instead of finding a comfortable grip on the handle
- Color coded for easy identification: Inch (yellow), Metric (red), Star (green)

ComfortGrip Screwdriver Handles

Bondhus was the first U.S. hex tool manufacturer to introduce cushioned grip style screwdriver handles for hex and star tools.

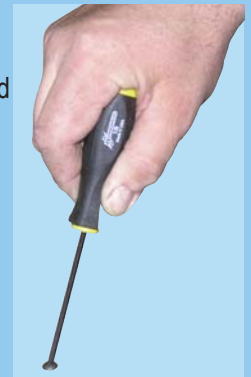

- Handles proportioned to blade size to prevent blade breakage
- Soft, cushioned handle with positive, non-slip surface
- Good grip even with wet or oily hands
- Reduces fatigue to accomplish more — with less effort
- Anti-roll on inclined or vibrating surfaces
- Color coded for easy identification: Inch (yellow), Metric (red), Star (green)

Star wing and flag handles



These are real time savers for special star and star plus applications.

- Can be gripped in many different ways
- The green handle top allows for rapid fingertip spinning of tool
- Handles generate needed torque to seat or break loose a screw — even the very delicate screws found in electronics applications

BONDHUS Timesaving GorillaProof Tools



ProGuard™ dry surface protection is yet another Bondhus exclusive. It is the most

effective solution in the industry for protecting tools from rust and corrosion.

Most hex tool manufacturers cut corners by providing inadequate protection against corrosion. Tool manufacturers deal with the problem of rust and corrosion by providing a range of solutions:

- Plating provides a degree of protection, but it eventually nicks, flakes or wears off, and allows water to seep in.
- Black oxide finishes provide only limited protection. Almost with the first use, the finish begins to wear off and allow water to penetrate through to the tool.

- Coating a tool with oil is nearly no protection at all. Almost immediately, it is vulnerable to rust and corrosion.

ProGuard™ dry surface finish is a radically different solution that offers vastly superior protection. It starts with caustic cleaning to remove all oxides and impurities on the surface. A proprietary electrolytic process is then used to grow a very tight and small grained crystal structure on the surface of the tool. In addition, a fast drying oil is used to provide yet a second line of protection. The resulting finish creates a surface that is very difficult for moisture and contaminants to penetrate.

Results of comparative Salt Spray performance testing, conducted by an independent lab, provide dramatic proof that the Bondhus ProGuard™ corrosion protection is up to five times more effective than any other solution available. Independent lab testing results are available within the

Tech Library section at www.bondhus.com.

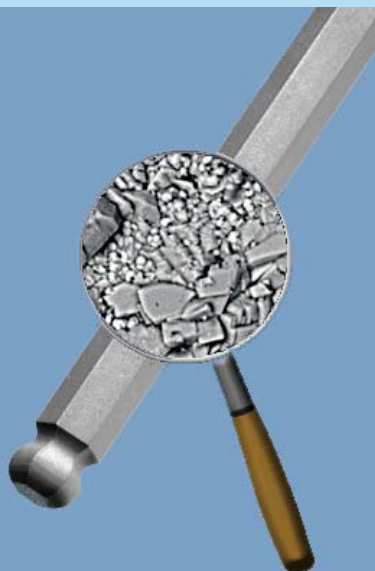

Actual corrosion after 10 hours exposure to salt spray

Consistency Of Machining:

Every manufacturer advertises the “quality” of their tools. Independent laboratory testing, however, reveals results that are not always consistent with those claims.

A tools’ effectiveness is directly proportional to how well it fits into a fastener. Bondhus manufactures tools to the tightest tolerances in the tool industry. Every tool is designed for the absolute optimal fit in a fastener. Tighter tolerances mean the best possible fit between tool and fastener will always be achieved.

The Bondhus specification demands stock that is free of defects created in the drawing process, sharp and clean corners, precise machining and a tightly sealed surface to prevent damage from corrosion.

A poorly machined ball end tip does not fit properly into a screw head. It risks stripping the screw head and may not produce a

smooth rotating action, further hampering tool use.

Machining a ball end on a small tool is very difficult to accomplish. Compare the precision of a Bondhus .050” ball end and the tool of a typical competitor. (See photo at bottom of page.) Bondhus means precision.

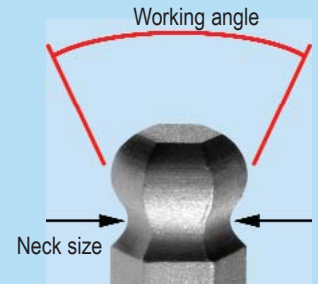

Strength and working angle are two of the primary characteristics by which ball end tips are rated. Increasing neck size produces a corresponding increase in strength, but does so at the expense of allowable working angle. Conversely, a smaller neck size increases working angle, but decreases strength.

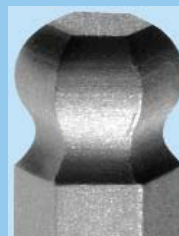

Bondhus Precision



Competitor poorly machined

.050” Ball end Comparison

No Burrs: The clearance between a hex key and the screw into which it is inserted is typically .0005" or less on each side of the key, and even a small burr can interfere with or prevent insertion. If the socket of a screw head is on the small side of its tolerance, and the hex key is on the large side, any amount of burr will prevent proper insertion.

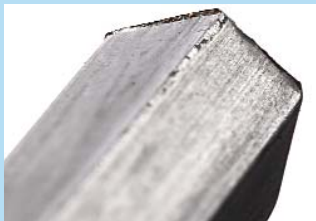

The imprecise nature of the competition's cutting method known as 'precision cutting' creates burrs that interfere with inserting the tool into a screw head.

Chamfering: Insertion of a straight hex or star tip into a screw head is much easier when all burrs are eliminated by chamfering the tip of the tool. Bondhus employs several styles of chamfers, using each style where it is most effective. The type of chamfer used is not critical. The point is to ensure that burrs are removed from all hex and star keys as shown by the Bondhus tool below.



Bondhus ball end tips are unique. They are capable of achieving superior torque while retaining a working angle of up to 25° because of

the superior torque and ductility characteristics of Protanium® steel. No other competitor can match this performance with common grades of steel.

Every Bondhus tool is subject to its own set of specifications. Bondhus is meticulous about quality control — no deviation from the spec, no seconds, no exceptions. Period.



At Bondhus, we believe in the quality of our tools and the warranty they carry is your proof. Not all warranties are created equal, and the tool industry is no exception. Reading the fine print often makes telling statements about the manufacturer's confidence in their own product.

Bondhus tools are designed by toolmakers to work hard, save time, and to last. Only Bondhus offers an unconditional lifetime warranty.

All Bondhus products are guaranteed for life. If you are not happy with a Bondhus® tool — for any reason — simply return it. A replacement will be shipped right out at no cost — no hassles, no questions asked!

Ergonomic Handle Designs

Good handle design doesn't just happen; it's the outcome of experience and design refinement performed by dedicated people who care about the tool user. Bondhus handles are designed by people who know, understand, and use tools for a living.

- **Tool user strength** is a major consideration in handle design because handles need to accommodate a range of hand strengths. Bondhus designs its handles to accommodate a wide range of user hand sizes and strengths.
- **Ergonomic designs** ensure all handles fit comfortably in the users hands. As a result, tool users experience less fatigue and the pain associated with aggressive or prolonged tool use. Non slip surfaces ensure good grip, even in wet or oily conditions.
- **Bondhus handles**, fitted with ball end blades, are designed and sized to match the torque capacity of each blade tip.
- **Blade torque** is accurately established for every blade and is consistently maintained in the manufacturing process. Variations in torque yield unpredictable results when the blade is coupled with a handle. Tool users can be confident that Bondhus handles will not over torque the blade, and result in damage to the tool.



Bondhus handles are well designed, are a joy to use, and greatly enhance a tool user's efficiency in performing a task. In addition, Bondhus handles are designed to protect both their blades and the fasteners they drive from wear and breakage.

ProHold® Tip Tools

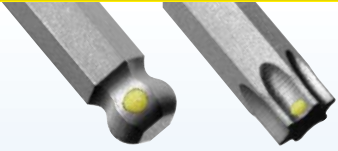

Available in a full range of hex ball end and star sizes:

- .050" to 3/8"
- 1.27mm to 10mm
- T9 to T60



Holds screws tight on the tool EVERY TIME

Button is non-magnetic

Super smooth rotational action, with no interference from the ProHold® button

Tool strength is not compromised by the ProHold® button



Patented ProHold® tip technology means never dropping a screw again

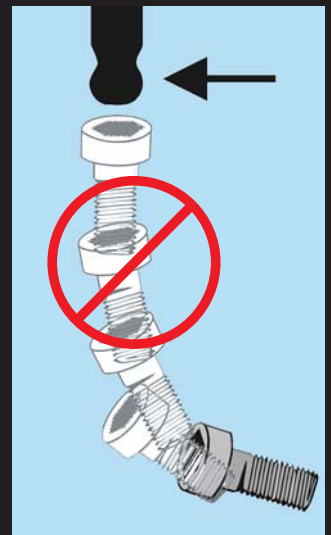

Color Coded

- Inch
- Metric
- Star

proanium High Torque Steel:

- Up to 20% stronger, with more torque and twice the wear resistance of standard grades of steel.

ProGuard Corrosion-resistant finish:

- Environmentally safe, provides better tool grip, resists solvents and is 5 times more corrosion resistant than competitor finishes.

ProHold® Tip Tools

Hex Key Sets

Inch Sizes



Long

SIZE	PCS	PART#	MODEL #	LIST EA
.050 – 3/8	13	74937	PBLX13	\$25.50
1/16 – 1/4	10	74938	PBLX10	15.90

Metric Sizes



Long

SIZE	PCS	PART#	MODEL #	LIST EA
1.5 – 6mm	7	74992	PBLX7M	\$12.62
1.5 – 10mm	9	74999	PBLX9M	20.70

Screwdriver Sets

Inch Sizes



SIZE	PCS	PART#	MODEL #	LIST EA
.050 – 5/32	8	74632	PBSX8S	\$24.40
.050 – 3/8	13	74637	PBSX13	57.05

Metric Sizes



SIZE	PCS	PART#	MODEL #	LIST EA
1.5 – 5mm	6	74686	PBSX6M	\$20.75
1.5 – 10mm	9	74699	PBSX9M	45.20

Hex Key Double Pack



SIZE	PCS	PART#	MODEL #	LIST EA
.050 – 3/8	22	20499	PBLX22	\$43.42
1.5 – 10mm				

Star Screwdriver Set



SIZE	PCS	PART#	MODEL #	LIST EA
T9 – T40	8	75534	PHTSX8	\$70.00

T-Handle Sets

Inch Sizes



SIZE	PCS	PART#	MODEL #	LIST EA
5/32 – 3/8	6	75146	PBTX60	\$40.85

Metric Sizes



SIZE	PCS	PART#	MODEL #	LIST EA
4 – 10mm	5	75148	PBTX50M	\$34.95

Star Hex Key Set



SIZE	PCS	PART#	MODEL #	LIST EA
T9 – T40	8	71834	PHTX8	\$21.25

Star T-Handle Set



SIZE	PCS	PART#	MODEL #	LIST EA
T9 – T40	8	74034	PHTTHX8	\$68.85

Star Tools

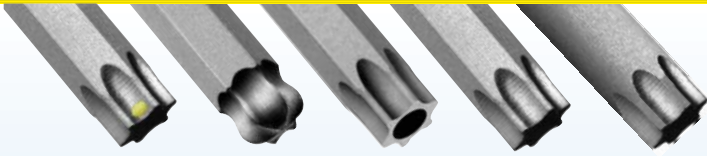

A full range of tip sizes from T5 to T60

Wing and flag tools are available in Star and Star Plus tip styles

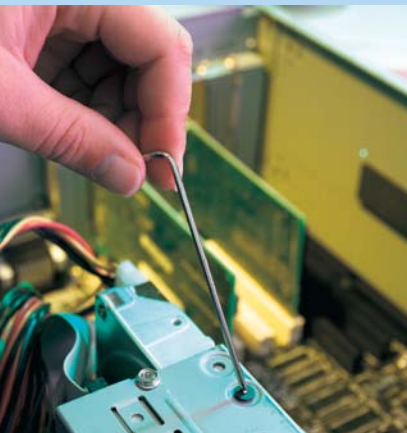

Unique Bondhus BallStar™ tips bring the advantages of a ball end to tasks requiring a star tip

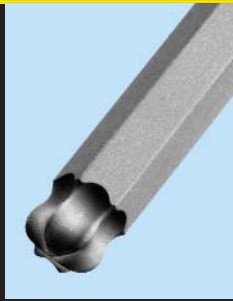

Precise machining of star tip means ease of entry and full engagement in screw



Wing and flag handles allow a variety of ways to grip the tool. Perfect for applications where other handle types might be awkward to use.



Generate the necessary torque — with ease

Color Coded

■ Star

ProLentium High Torque Steel:

- Up to 20% stronger, with more torque and twice the wear resistance of standard grades of steel.

ProGuard Corrosion-resistant finish:

- Environmentally safe, provides better tool grip, resists solvents and is 5 times more corrosion resistant than competitor finishes.

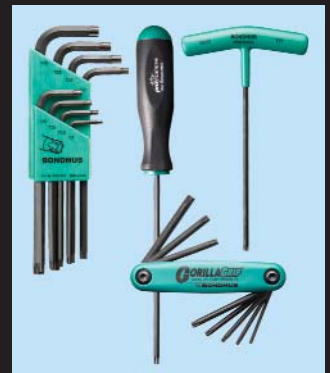

Bondhus Star and Star Plus tools fit TORX® brand screws.

Star Tools

Hex Key Sets



		ProHold® Star Tip			BallStar™ Tip			Star Tip			Tamper-Resistant Tip		
SIZE	PCS	PART#	MODEL #	LIST EA	PART#	MODEL #	LIST EA	PART#	MODEL #	LIST EA	PART#	MODEL #	LIST EA
T6 – T25	8				11331	LTX8S	\$37.25	31832	TLX8S	\$16.35	32432	TR-TL8S	\$25.00
T9 – T40	8	71834	PHTX8	\$21.25	11332	LTX8	41.91	31834	TLX8	14.10	32434	TR-TL8	21.35
T6 – T15	6				11346	LTX6	26.88						
Short Arm:													
T6 – T25	8							31732	TLXS8S	14.20			
T9 – T40	8							31734	TLXS8	12.30			

T-Handle Sets with Stand



		ProHold® Tip			Star Tip				
SIZE	PCS	LENGTH	W/STAND	PART#	MODEL#	LIST EA	PART#	MODEL#	LIST EA
T9 – T40	8	Graduated	✓	74034	PHTTHX8	\$68.85	33034	TTHX8	\$45.00

Screwdriver Sets



		ProHold® Tip			Ballstar™ Tip			Star Tip			Tamper-Resistant Tip		
SIZE	PCS	PART#	MODEL #	LIST EA	PART#	MODEL #	LIST EA	PART#	MODEL #	LIST EA	PART#	MODEL #	LIST EA
T6 – T25	8							34532	TSX8S	\$34.40	33832	TR-SX8S	\$57.00
T6 – T15	6				13546	STX6	\$38.05						
T9 – T40	8	75534	PHTSX8	\$70.00	13532	STX8	56.46	34534	TSX8	39.99	33834	TR-SX8	73.00

GorillaGrip® Fold Ups



		Star Tip			Tamper-Resistant Tip		
SIZE	PCS	PART#	MODEL#	LIST EA	PART#	MODEL#	LIST EA
T6 – T25	8	12632	TF8S	\$12.85			
T7 – T25	7				12636	TR-TF7S	\$13.05
T9 – T40	8	12634	TF8	13.10	12638	TR-TF8	15.40



Star Tools

Wing and Flag handle drivers are perfect for insertion and removal of insert tooling in oily environments

- Available in sizes T5 – T20
- Star and Star Plus
- Soft rubber outer coating for maximum comfort and grip
- Tough thermoplastic core
- Protanium® steel and ProGuard™ Finish



Wing Handle Set

SIZE	PCS	PART#	MODEL#	LIST EA	PART#	MODEL#	LIST EA
T6 – T20	7	34745	TWX7	\$25.05	33945	TPWX7	\$28.85

Flag Handle Set

SIZE	PCS	PART#	MODEL#	LIST EA	PART#	MODEL#	LIST EA
T6 – T20	7	34445	TFX7	\$24.00	35045	TPFX7	\$27.80

Wing Handle Singles

SIZE	QTY	PART#	INCH	MM	LIST EA	PART#	INCH	MM	LIST EA
T6	2	34706	1.5	37	\$3.15	33906	2.0	50	\$3.35
T7	2	34707	1.5	37	3.15	33907	2.0	50	3.35
T8	2	34708	1.5	37	3.15	33908	2.0	50	3.35
T9	2	34709	1.5	37	3.15	33909	2.0	50	3.75
T10	2	34710	1.5	37	3.15	33910	2.0	50	3.75
T15	2	34715	1.5	37	3.15	33915	2.0	50	3.95
T20	2	34720	1.5	37	3.15	33920	2.0	50	4.35

Flag Handle Singles

SIZE	QTY	PART#	INCH	MM	LIST EA	PART#	INCH	MM	LIST EA
T5	2	34405	1.5	37	\$3.00				
T6	2	34406	1.5	37	3.00	35006	2.0	50	\$3.20
T7	2	34407	1.5	37	3.00	35007	2.0	50	3.20
T8	2	34408	1.5	37	3.00	35008	2.0	50	3.20
T9	2	34409	1.5	37	3.00	35009	2.0	50	3.60
T10	2	34410	1.5	37	3.00	35010	2.0	50	3.60
T15	2	34415	1.5	37	3.00	35015	2.0	50	3.80
T20	2	34420	1.5	37	3.00	35020	2.0	50	4.20

T-Handle Singles — Graduated Lengths

SIZE	QTY	INCH	MM	PART#	LIST EA	PART#	LIST EA
T9	2	6.1	155	74009	\$6.85	33009	\$4.30
T10	2	6.4	161	74010	7.20	33010	4.50
T15	2	6.6	168	74015	7.65	33015	4.80
T20	2	6.9	174	74020	8.00	33020	5.00
T25	2	7.1	180	74025	8.30	33025	5.20
T27	2	7.4	187	74027	8.80	33027	5.50
T30	2	7.6	193	74030	9.25	33030	5.80
T40	2	7.9	199	74040	10.40	33040	6.50
T45	2	8.1	206	74045	11.60	33045	7.25
T50	2	8.4	213	74050	13.60	33050	8.50
T55	2	8.6	218	74055	15.00	33055	11.00



Star Tools

Hex Key Singles

★	ProHold® Star Tip			BallStar™ Tip			Star Tip			Tamper-Resistant Tip			Star Tip Short		
	SIZE	INCH	MM	QTY	PART#	LIST EA	QTY	PART#	LIST EA	QTY	PART#	LIST EA	QTY	PART#	LIST EA
	T5														
	T6	2.1	55				5	11706	\$4.34	5	31806	\$2.90	2	32406	\$4.35
	T7	2.4	61				5	11707	4.34	5	31807	2.60	2	32407	4.00
	T8	2.6	67				5	11708	4.34	5	31808	2.60	2	32408	4.00
	T9	2.9	74	5	71809	\$3.90	5	11709	4.34	5	31809	2.60	2	32409	4.00
	T10	3.2	80	5	71810	2.20	5	11710	4.68	5	31810	1.45	2	32410	2.20
	T15	3.3	84	5	71815	2.25	5	11715	4.85	5	31815	1.50	2	32415	2.30
	T20	3.6	91	5	71820	2.35	5	11720	5.00	5	31820	1.55	2	32420	2.40
	T25	3.8	98	5	71825	2.50	5	11725	5.37	5	31825	1.65	2	32425	2.50
	T27	4.2	106	5	71827	2.55	5	11727	5.54	5	31827	1.70	2	32427	2.60
	T30	4.6	116	5	71830	2.85	5	11730	5.71	5	31830	1.90	2	32430	2.85
	T40	4.9	125	5	71840	3.10	5	11740	6.40	5	31840	2.05	2	32440	2.95
	T45	5.4	138	2	71845	4.20	1	11745	7.62	2	31845	2.80			
	T50	6.2	156	2	71850	5.25	1	11750	8.49	2	31850	3.50			
	T55	6.7	171	2	71855	7.90	1	11755	11.45	2	31855	5.25			
	T60	7.2	182	2	71860	10.35				2	31860	6.90			

Screwdriver Singles

★	ProHold® Tip				Tamper-Resistant Tip				Star Tip					
	SIZE	QTY	INCH	MM	PART#	LIST EA	PART#	LIST EA	SIZE	QTY	INCH	MM	PART#	LIST EA
	T6	1	4.3	108			33806	\$6.50	T5	2	4.0	102	34505	\$5.00
	T7	1	4.5	114			33807	6.50	T6	2	4.3	108	34506	3.90
	T8	1	4.8	121			33808	6.50	T7	2	4.5	114	34507	3.80
	T9	1	4.9	124	75509	\$6.50	33809	6.70	T8	2	4.8	121	34508	3.80
	T10	1	5.0	128	75510	6.80	33810	6.70	T9	2	4.9	124	34509	4.10
	T15	1	5.1	131	75515	7.00	33815	6.85	T10	2	5.0	128	34510	4.30
	T20	1	5.4	138	75520	7.60	33820	8.60	T15	2	5.1	131	34515	4.40
	T25	1	5.7	144	75525	8.40	33825	8.65	T20	2	5.4	138	34520	4.80
	T27	1	5.8	147	75527	9.70	33827	10.25	T25	2	5.7	144	34525	5.30
	T30	1	6.0	153	75530	11.50	33830	12.25	T27	2	5.8	147	34527	6.10
	T40	1	6.3	159	75540	12.50	33840	13.25	T30	2	6.0	153	34530	7.20
	T45	1	6.5	166	75545	13.00			T40	2	6.3	159	34540	7.85
	T50	1	6.8	172	75550	14.50			T45	1	6.5	166	34545	8.20
	T55	1	7.0	178	75555	16.20			T50	1	6.8	172	34550	9.10
	T60	1	7.3	185	75560	17.90			T55	1	7.0	178	34555	10.15
									T60	1	7.3	185	34560	11.20

★	BallStar™ Tip					
	SIZE	QTY	INCH	MM	PART#	LIST EA
	T6	2	2.6	62	12706	\$6.23
	T7	2	2.6	62	12707	6.23
	T8	2	2.6	62	12708	6.23
	T9	2	2.6	62	12709	6.23
	T10	2	2.8	69	12710	6.57
	T15	2	2.9	73	12715	6.57
	T20	2	3.2	81	12720	6.75
	T25	2	3.4	87	12725	6.93
	T27	2	3.8	97	12727	7.29
	T30	2	4.2	106	12730	7.79
	T40	2	4.6	117	12740	8.32
	T45	1	5.2	132	12745	9.87
	T50	1	6.0	153	12750	11.78
	T55	1	6.8	172	12755	14.15



Ball End Tools

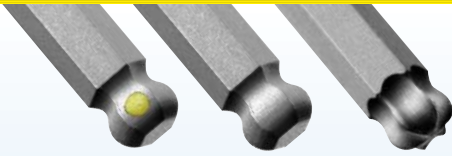

Balldriver® tools are tremendous time savers

High quality machining means:

- Smooth rotational action
- Extended tip life
- Reduced fastener wear

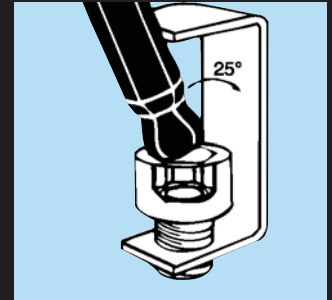
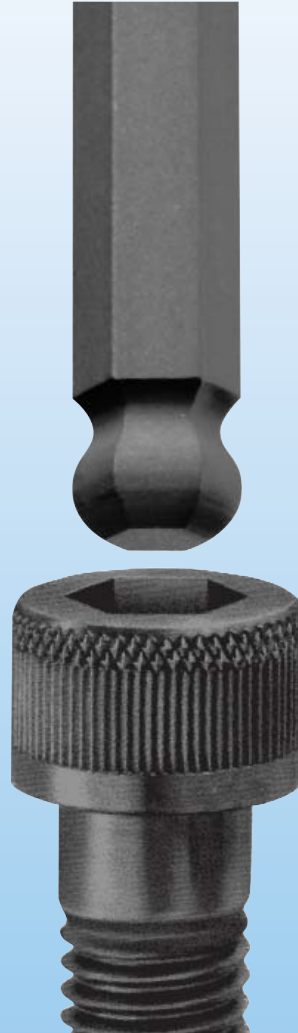
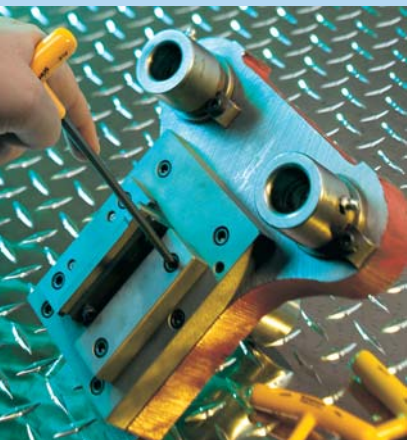

Screws insert into screw head quickly, from up to a 25° angle, even when working in blind locations

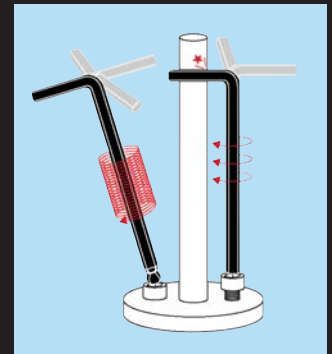

Work efficiently, even near obstructions

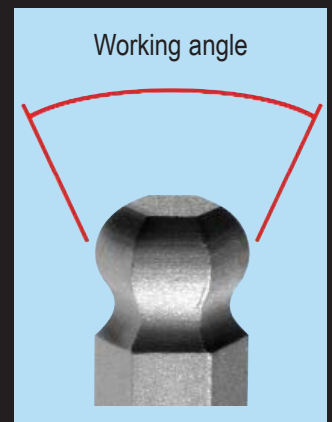

Engineered to deliver the perfect balance between tip strength and working angle

Color Coded

- Inch
- Metric
- Star

Proanium HIGH TORQUE STEEL High Torque Steel:

- Up to 20% stronger, with more torque and twice the wear resistance of standard grades of steel.

ProGuard DRY SURFACE TECHNOLOGY DST Corrosion-resistant finish:

- Environmentally safe, provides better tool grip, resists solvents and is 5 times more corrosion resistant than competitor finishes.

Ball End Tool Sets

Ball end Hex Key Sets

Inch Sizes

Inch Sizes															Pro-Hold® Tip	ProGuard™	GoldGuard™	BriteGuard™	Stubby	PCS	Long		
.050	1/16	5/64	3/32	7/64	1/8	9/64	5/32	3/16	7/32	1/4	5/16	3/8						PART#	MODEL#	LIST EA			
•	•	•	•	•	•	•	•	•	•	•	•	•		✓				8	10932	BLX8	\$7.45		
•	•	•	•	•	•	•	•	•	•	•	•	•		✓				12	10936	BLX12	12.88		
•	•	•	•	•	•	•	•	•	•	•	•	•			✓			12	37936	BLX12G	16.45		
•	•	•	•	•	•	•	•	•	•	•	•	•				✓		12	16936	BLX12B	16.45		
•	•	•	•	•	•	•	•	•	•	•	•	•	PH	✓				13	74937	PBLX13	25.50		
•	•	•	•	•	•	•	•	•	•	•	•	•		✓				13	10937	BLX13	16.50		
•	•	•	•	•	•	•	•	•	•	•	•	•			✓			13	37937	BLX13G	21.05		
•	•	•	•	•	•	•	•	•	•	•	•	•				✓		13	16937	BLX13B	21.05		
•	•	•	•	•	•	•	•	•	•	•	•	•		✓			✓	13	16537	SBLX13	20.25		
•	•	•	•	•	•	•	•	•	•	•	•	•	PH	✓			✓	13	16737	SBLX13B	26.80		
•	•	•	•	•	•	•	•	•	•	•	•	•		✓				10	74938	PBLX10	15.90		
•	•	•	•	•	•	•	•	•	•	•	•	•		✓				10	10938	BLX10	10.29		
•	•	•	•	•	•	•	•	•	•	•	•	•			✓			10	37938	BLX10G	13.15		
•	•	•	•	•	•	•	•	•	•	•	•	•				✓		10	16938	BLX10B	13.15		
•	•	•	•	•	•	•	•	•	•	•	•	•		✓			✓	10	16538	SBLX10	12.65		
•	•	•	•	•	•	•	•	•	•	•	•	•				✓	✓	10	16738	SBLX10B	16.75		
•	•	•	•	•	•	•	•	•	•	•	•	•		✓				7	10945	BLX7	6.99		

Metric Sizes

Metric Sizes															Extra Long			Long			
1.27	1.5	2.0	2.5	3.0	3.5	4.0	4.5	5.0	5.5	6.0	7.0	8.0	9.0	10.0	PCS	PART#	MODEL#	LIST EA	PART#	MODEL#	LIST EA
•	•	•	•	•	•	•	•	•	•	•	•	•	•	•					10995	BLX15M	\$22.50
•	•	•	•	•	•	•	•	•	•	•	•	•	•	•					38095	BLX15MG	28.70
•	•	•	•	•	•	•	•	•	•	•	•	•	•	•		17095	BLX15MB	\$28.70			
•	•	•	•	•	•	•	•	•	•	•	•	•	•	•					10946	BLX6M	6.10
•	•	•	•	•	•	•	•	•	•	•	•	•	•	•					38046	BLX6MG	7.80
•	•	•	•	•	•	•	•	•	•	•	•	•	•	•					17046	BLX6MB	7.80
•	•	•	•	•	•	•	•	•	•	•	•	•	•	•					74992	PBLX7M	12.62
•	•	•	•	•	•	•	•	•	•	•	•	•	•	•	PH	✓			10992	BLX7M	8.17
•	•	•	•	•	•	•	•	•	•	•	•	•	•	•		✓			16592	SBLX7M	10.00
•	•	•	•	•	•	•	•	•	•	•	•	•	•	•				✓	16792	SBLX7MB	13.30
•	•	•	•	•	•	•	•	•	•	•	•	•	•	•				✓	38092	BLX7MG	10.45
•	•	•	•	•	•	•	•	•	•	•	•	•	•	•					17092	BLX7MB	10.45
•	•	•	•	•	•	•	•	•	•	•	•	•	•	•					74999	PBLX9M	20.70
•	•	•	•	•	•	•	•	•	•	•	•	•	•	•	PH	✓			10999	BLX9M	13.40
•	•	•	•	•	•	•	•	•	•	•	•	•	•	•		✓			16599	SBLX9M	16.45
•	•	•	•	•	•	•	•	•	•	•	•	•	•	•				✓	16799	SBLX9MB	21.75
•	•	•	•	•	•	•	•	•	•	•	•	•	•	•				✓	38099	BLX9MG	17.10
•	•	•	•	•	•	•	•	•	•	•	•	•	•	•					17099	BLX9MB	17.10









Ball End Tool Sets

Double Packs

Combinations of our most popular sets

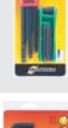







- Two sets per package
- Tip selections include Balldriver®, Hex, Star and ProHold® tips

TIPS	INCH SIZE	METRIC SIZE	STAR SIZE	TOOLS	PART#	MODEL #	LIST EA
 		1.5 - 10mm Ball end hex key set		16pcs	14187	BLF16	\$19.30
 		2 – 8mm Hex tip GorillaGrip® fold up					
 	.050 - 3/8 Ball end hex key set			22pcs	14189	BLF22	21.60
 	5/64 – 1/4 Hex tip GorillaGrip® fold up						
 	.050 – 3/8 Ball end hex key set	1.5 – 10mm Ball end hex key set		22pcs	20199	BLX22	28.20
 	.050 – 5/16 Ball end hex key set	1.5 – 10mm Ball end hex key set		21pcs	20196	BLX21	24.84
 	.050 – 3/8 Ball end hex key set	1.5 – 10mm Ball end hex key set		22pcs	20899	BLX22G <i>(with GoldGuard™ finish)</i>	36.00
 	.050 - 3/8 Stubby Ball end hex key set	1.5 – 10mm Stubby Ball end hex key set		22pcs	20599	SBLX22	34.65
 	.050 – 3/8 Ball end hex key set with ProHold® tip	1.5 – 10mm Ball end hex key set with ProHold® tip		22pcs	20499	PBLX22	43.42
 		1.5 – 10mm Ball end hex key set	T6 – T25 GorillaGrip® fold up	17pcs	14126	BLF17S	24.60
 		1.5 – 10mm Ball end hex key set	T9 – T40 GorillaGrip® fold up	17pcs	14128	BLF17	24.80
Hex Tip  	.050 – 3/8 Hex key Set	1.5 – 10mm hex key set		22pcs	22199	HLX22	17.50

Triple Packs

Balldriver®, Hex & Star Tips

Three tool sets per package — two hex key sets and one GorillaGrip® Fold Up

TIPS	INCH SIZE	METRIC SIZE	STAR SIZE	TOOLS	PART#	MODEL #	LIST EA
 	.050 – 3/8 Ball end hex key set	1.5 – 10mm Ball end hex key set		34pcs	14130	BLF34	\$36.85
 	5/64 – 5/32 and 1.5 – 5mm hex GorillaGrip® fold up						
 	.050 – 3/8 Ball end hex key set	1.5 – 10mm Ball end hex key set	T6 – T25 Star GorillaGrip® fold up	30pcs	14132	BLF30TS	40.35
 	.050 – 3/8 Ball end hex key set	1.5 – 10mm Ball end hex key set	T9 – T40 Star GorillaGrip® fold up	30pcs	14138	BLF30T	40.60

Ball End Tool Sets

T-Handle Sets



Inch Sizes



SIZE	PCS	PART#	MODEL #	LIST EA
3/32 – 3/8	10	13138	BTX10	\$49.45
5/32 – 3/8	6	13146	BTX60	36.65
3/32 – 3/8	10	13190	BTX10/S*	52.70

Metric Sizes

SIZE	PCS	PART#	MODEL #	LIST EA
4 – 10mm	5	13148	BTX50M	\$31.50
2 – 10mm	8	13187	BTX80M	40.55
2 – 10mm	8	13189	BTX80M/S*	43.80

*With Stand

GorillaGrip® Sets



Inch Sizes



SIZE	PCS	PART#	MODEL #	LIST EA
3/16 – 3/8	5	12894	BF5	\$13.05

Metric Sizes

SIZE	PCS	PART#	MODEL #	LIST EA
5 – 10mm	5	12897	BF5M	\$13.05

Power Bit Sets

Inch Sizes



SIZE	PCS	PART#	MODEL #	LIST EA
5/64 – 1/2	12	10836	BHX12	\$32.46

Metric Sizes

SIZE	PCS	PART#	MODEL #	LIST EA
2 – 12mm	9	10899	BHX9M	\$27.90

BallStar™ Screwdriver Sets



SIZE	PCS	PART#	MODEL #	LIST EA
T9 – T40	8	13532	STX8	\$56.46
T6 – T15	6	13546	STX6	38.05

Screwdriver Sets

Inch Sizes



SIZE	PCS	PART#	MODEL #	LIST EA
.050 – 5/32	8	10632	BSX8S	\$20.60
7/64 – 5/16	8	10633	BSX8	33.40
.050 – 3/8	13	10637	BSX13	49.55
5/64 – 3/16	7	10645	BSX7	20.40
5/64 – 3/8	11	10737	BSX11L	54.40

Metric Sizes

SIZE	PCS	PART#	MODEL #	LIST EA
1.5 – 5mm	6	10686	BSX6M	\$17.75
1.27 – 5mm	7	10687	BSX7M	19.80
1.5 – 10mm	9	10699	BSX9M	39.05
2 – 10mm	8	10733	BSX8ML	44.50

Insert Bit Sets

Inch Sizes



SIZE	PCS	PART#	MODEL #	LIST EA
5/64 – 1/2	12	11036	BIX12	\$27.26

Metric Sizes

SIZE	PCS	PART#	MODEL #	LIST EA
2 – 12mm	9	11099	BIX9M	\$23.98

BallStar™ Hex Key Sets



SIZE	PCS	PART#	MODEL #	LIST EA
T6 – T25	8	11331	LTX8S	\$37.25
T9 – T40	8	11332	LTX8	41.91
T6 – T15	6	11346	LTX6	26.88

Stubby Tools



Low profile short arm allows entry into tight spots

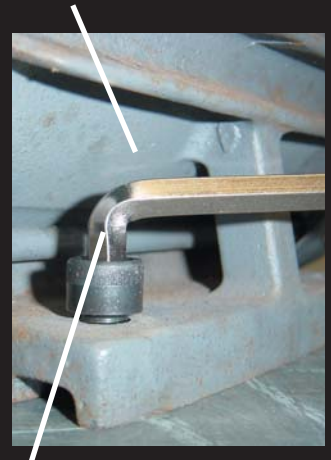

Smaller inside radius for tight spaces

Ball end tip on long arm for fast insertion or extraction

Standard hex key can't fit in tight spots



Stubby hex keys eliminate the need to trim and file the short arm. A trimmed hex key introduces burrs, and still does not have the tight radius of a dedicated Stubby wrench.

Color Coded

- Inch
- Metric

Proanium HIGH TORQUE STEEL High Torque Steel:

- Up to 20% stronger, with more torque and twice the wear resistance of standard grades of steel.

ProGuard DRY SURFACE TECHNOLOGY **DST** Corrosion-resistant finish:

- Environmentally safe, provides better tool grip, resists solvents and is 5 times more corrosion resistant than competitor finishes.

Stubby Tools

Stubby Balldriver® Sets with ProGuard™ finish



Inch Sizes



Balldriver® Tip Long

SIZE	PCS	PART#	MODEL #	LIST EA
.050 – 3/8	13	16537	SBLX13	\$20.25
1/16 – 1/4	10	16538	SBLX10	12.65

Metric Sizes



Balldriver® Tip Long

SIZE	PCS	PART#	MODEL #	LIST EA
1.5 – 6mm	7	16592	SBLX7M	\$10.00
1.5 – 10mm	9	16599	SBLX9M	16.45

Stubby Balldriver® Sets with BriteGuard™ finish



Inch Sizes



Balldriver® Tip Long

SIZE	PCS	PART#	MODEL #	LIST EA
.050 – 3/8	13	16737	SBLX13B	\$26.80
1/16 – 1/4	10	16738	SBLX10B	16.75

Metric Sizes



Balldriver® Tip Extra Long

SIZE	PCS	PART#	MODEL #	LIST EA
1.5 – 6mm	7	16792	SBLX7MB	\$13.30
1.5 – 10mm	9	16799	SBLX9MB	21.75

Stubby Balldriver® Singles with ProGuard™ finish



Inch Sizes



Balldriver® Tip Long Tagged/Barcoded

SIZE	INCH	MM	INCH	MM	Tagged/Barcoded			Bulk		
					QTY	PART#	LIST EA	QTY	PART#	LIST EA
.050	2.8	72	.19	5	5	16502	\$1.10	50	26502	\$0.99
1/16	3.0	76	.16	4	5	16503	1.10	50	26503	0.99
5/64	3.2	81	.27	7	5	16504	1.10	50	26504	0.99
3/32	3.4	86	.29	7	5	16505	1.15	50	26505	1.04
7/64	3.6	90	.30	8	5	16506	1.30	50	26506	1.17
1/8	3.8	95	.32	8	5	16507	1.35	50	26507	1.22
9/64	4.0	101	.33	8	5	16508	1.35	50	26508	1.22
5/32	4.2	107	.35	9	5	16509	1.40	50	26509	1.26
3/16	4.5	114	.39	10	5	16510	1.60	50	26510	1.44
7/32	4.9	124	.46	12	2	16511	1.95	25	26511	1.76
1/4	5.3	133	.46	12	2	16512	2.25	25	26512	2.03
5/16	6.0	152	.57	14	2	16513	3.50	25	26513	3.15
3/8	6.8	171	.71	18	2	16514	4.90	25	26514	4.41

Metric Sizes



Balldriver® Tip Long Tagged/Barcoded

SIZE	INCH	MM	INCH	MM	Tagged/Barcoded			Bulk		
					QTY	PART#	LIST EA	QTY	PART#	LIST EA
1.27	2.8	72	.19	5	5	16549	\$1.10	50	26549	\$0.99
1.5	3.0	77	.25	6	5	16550	1.10	50	26550	0.99
2.0	3.2	82	.27	7	5	16552	1.10	50	26552	0.99
2.5	3.5	88	.28	7	5	16554	1.15	50	26554	1.04
3	3.9	98	.32	8	5	16556	1.35	50	26556	1.22
4	4.3	110	.35	9	5	16560	1.40	50	26560	1.26
5	4.7	119	.40	10	2	16564	1.80	25	26564	1.62
6	5.5	139	.47	12	2	16568	2.35	25	26568	2.12
8	6.4	162	.57	14	2	16572	3.80	25	26572	3.42
10	7.4	187	.72	18	2	16576	5.60	25	26576	5.04

Stubby Balldriver® Singles with BriteGuard™ finish



Inch Sizes



Balldriver® Tip Long Tagged/Barcoded

SIZE	INCH	MM	INCH	MM	Tagged/Barcoded			Bulk		
					QTY	PART#	LIST EA	QTY	PART#	LIST EA
.050	2.8	72	.19	5	5	16702	\$1.39	50	26702	\$1.26
1/16	3.0	76	.16	4	5	16703	1.39	50	26703	1.26
5/64	3.2	81	.27	7	5	16704	1.39	50	26704	1.26
3/32	3.4	86	.29	7	5	16705	1.44	50	26705	1.30
7/64	3.6	90	.30	8	5	16706	1.65	50	26706	1.48
1/8	3.8	95	.32	8	5	16707	1.70	50	26707	1.53
9/64	4.0	101	.33	8	5	16708	1.70	50	26708	1.53
5/32	4.2	107	.35	9	5	16709	1.75	50	26709	1.58
3/16	4.5	114	.39	10	5	16710	2.01	50	26710	1.81
7/32	4.9	124	.46	12	2	16711	2.42	25	26711	2.18
1/4	5.3	133	.46	12	2	16712	2.83	25	26712	2.55
5/16	6.0	152	.57	14	2	16713	4.38	25	26713	3.94
3/8	6.8	171	.71	18	2	16714	6.18	25	26714	5.56

Metric Sizes



Balldriver® Tip Extra Long Tagged/Barcoded

SIZE	INCH	MM	INCH	MM	Tagged/Barcoded			Bulk		
					QTY	PART#	LIST EA	QTY	PART#	LIST EA
1.27	2.8	72	.19	5	5	16749	\$1.39	50	26749	\$1.26
1.5	3.5	90	.25	6	5	16750	1.39	50	26750	1.26
2.0	3.9	100	.27	7	5	16752	1.39	50	26752	1.26
2.5	4.4	112	.28	7	5	16754	1.44	50	26754	1.30
3	5.0	126	.32	8	5	16756	1.65	50	26756	1.48
4	5.6	142	.35	9	5	16760	1.75	50	26760	1.58
5	6.3	160	.40	10	2	16764	2.21	25	26764	2.00
6	6.8	172	.47	12	2	16768	2.94	25	26768	2.65
8	7.7	195	.57	14	2	16772	4.79	25	26772	4.32
10	8.8	224	.72	18	2	16776	6.95	25	26776	6.26

Hex Key Tools

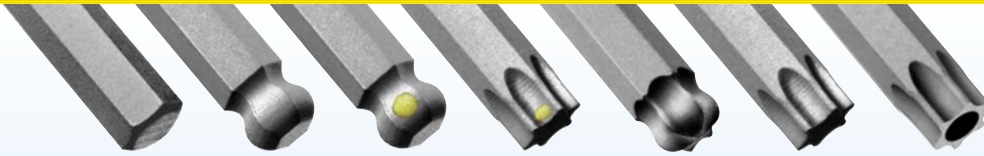

Chamfered tips for fast insertion and full tool engagement in the screw head

Twist-to-Lock case keeps keys organized by size

Sizes are printed on the case, making it easy to locate tools

Cases marked and color coded

Sorts and prevents loose or lost hex keys



Twist to lock keys securely in place



Case may be used to increase leverage

Burr prevents key from fitting

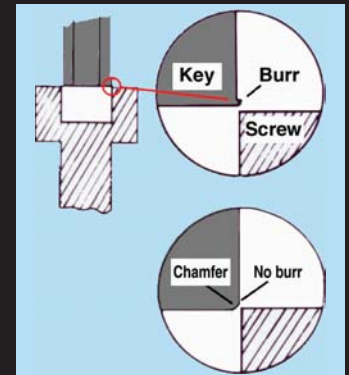

Chamfered Bondhus key slides easily into screw head

Color Coded

- Inch
- Metric
- Star

Proanium High Torque Steel:

- Up to 20% stronger, with more torque and twice the wear resistance of standard grades of steel.

ProGuard DST Corrosion-resistant finish:

- Environmentally safe, provides better tool grip, resists solvents and is 5 times more corrosion resistant than competitor finishes.



Hex and Star wrenches are also available

Hex Key Sets

Extra Long, Long, Short & Stubby

Hex Key Sets

Inch Sizes

SIZE	LENGTH	ProGuard™			ProHold® Tip			Balldriver® Tip			Hex Tip		
		GoldGuard™	BriteGuard™	PCS	PART#	MODEL #	LIST EA	PART#	MODEL #	LIST EA	PART#	MODEL #	LIST EA
.050 – 5/32	Long	✓		8							12132	HLX8	\$4.30
	Short	✓		8							12232	HLX8S	3.75
.050 – 5/16	Long	✓		12				10936	BLX12	12.88	12136	HLX12	7.50
	Long		✓	12				37936	BLX12G	16.45	38136	HLX12G	10.15
"	Long		✓	12				16936	BLX12B	16.45	16136	HLX12B	10.15
"	Short	✓		12							12236	HLX12S	5.40
"	Short		✓	12							16236	HLX12SB	7.20
"	Short		✓	12							38236	HLX12SG	7.20
.050 – 3/8	Long	✓		13	74937	PBLX13	\$25.50	10937	BLX13	16.50	12137	HLX13	9.45
	Long		✓	13				37937	BLX13G	21.05	38137	HLX13G	13.40
"	Long		✓	13				16937	BLX13B	21.05	16137	HLX13B	13.40
"	Short	✓		13							12237	HLX13S	6.50
"	Short		✓	13							16237	HLX13SB	9.55
"	Short		✓	13							38237	HLX13SG	9.55
"	Stubby	✓		13				16537	SBLX13	20.25			
"	Stubby		✓	13				16737	SBLX13B	26.80			
1/16 – 1/4	Long	✓		10	74938	PBLX10	15.90	10938	BLX10	10.29	12138	HLX10	5.25
	Long		✓	10				37938	BLX10G	13.15	38138	HLX10G	7.15
"	Long		✓	10				16938	BLX10B	13.15	16138	HLX10B	7.15
"	Short	✓		10							12238	HLX10S	4.75
"	Short		✓	10							16238	HLX10SB	5.90
"	Short		✓	10							38238	HLX10SG	5.90
"	Stubby	✓		10				16538	SBLX10	12.65			
"	Stubby		✓	10				16738	SBLX10B	16.75			
5/64 – 3/16	Long	✓		7				10945	BLX7	6.99	12145	HLX7	3.75
	Short	✓		7							12245	HLX7S	3.40

SIZE	LENGTH	ProGuard™			ProHold® Tip			Balldriver® Tip			Hex Tip		
		GoldGuard™	BriteGuard™	PCS	PART#	MODEL #	LIST EA	PART#	MODEL #	LIST EA	PART#	MODEL #	LIST EA
1.5 – 5mm	Long		✓	6				38046	BLX6MG	\$7.80	39146	HLX6MG	\$6.15
	Extra Long			6				17046	BLX6MB	7.80	17146	HLX6MB	6.15
"	Long	✓		6				10946	BLX6M	6.10	12146	HLX6M	4.45
"	Short	✓		6							12246	HLX6MS	4.00
"	Short		✓	6							16246	HLX6MSB	4.95
"	Short		✓	6							38246	HLX6MSG	4.95
1.5 – 6mm	Long		✓	7				38092	BLX7MG	10.45	39192	HLX7MG	7.95
	Extra Long			7				17092	BLX7MB	10.45	17192	HLX7MB	7.95
"	Long	✓		7	74992	PBLX7M	\$12.62	10992	BLX7M	8.17	12192	HLX7M	5.65
"	Short	✓		7							12292	HLX7MS	4.65
"	Short		✓	7							16292	HLX7MSB	6.05
"	Short		✓	7							38292	HLX7MSG	6.05
"	Stubby	✓		7				16592	SBLX7M	10.00			
"	Stubby		✓	7				16792	SBLX7MB	13.30			
1.5 – 10mm	Long		✓	9				38099	BLX9MG	17.10	39199	HLX9MG	12.65
	Extra Long			9				17099	BLX9MB	17.10	17199	HLX9MB	12.65
"	Long	✓		9	74999	PBLX9M	20.70	10999	BLX9M	13.40	12199	HLX9M	9.00
"	Short	✓		9							12299	HLX9MS	7.20
"	Short		✓	9							16299	HLX9MSB	8.90
"	Short		✓	9							38299	HLX9MSG	8.90
"	Stubby	✓		9				16599	SBLX9M	16.45			
"	Stubby		✓	9				16799	SBLX9MB	21.75			
1.27 – 10mm	Long	✓		15				10995	BLX15M	22.50	12195	HLX15M	15.10
	Long		✓	15				38095	BLX15MG	28.70	39195	HLX15MG	22.60
"	Extra Long		✓	15				17095	BLX15MB	28.70	17195	HLX15MB	22.60



Hex Keys

Balldriver® & Hex Singles with ProGuard™ finish Long

Inch Sizes			ProHold® Tip Long Tagged/Barcoded						Balldriver® Tip Long Tagged/Barcoded						Hex Tip Long Tagged/Barcoded					
SIZE	INCH	MM	QTY	PART#	LIST EA	QTY	PART#	LIST EA	QTY	PART#	LIST EA	QTY	PART#	LIST EA	QTY	PART#	LIST EA	QTY	PART#	LIST EA
.028	2.6	66													10	15900	\$0.55	100	13900	\$0.28
.035	2.7	68													10	15901	0.55	100	13901	0.28
.050	2.8	72	5	75702	\$1.38	25	75902	\$1.13	10	15702	\$0.92	100	12902	\$0.63	10	15902	0.31	100	13902	0.14
1/16	3.0	76	5	75703	1.38	25	75903	1.13	10	15703	0.92	100	12903	0.63	10	15903	0.34	100	13903	0.16
5/64	3.2	81	5	75704	1.38	25	75904	1.16	10	15704	0.92	100	12904	0.65	10	15904	0.34	100	13904	0.16
3/32	3.4	86	5	75705	1.44	25	75905	1.22	10	15705	0.96	100	12905	0.70	10	15905	0.34	100	13905	0.16
7/64	3.6	90	5	75706	1.63	25	75906	1.40	10	15706	1.09	100	12906	0.80	10	15906	0.41	100	13906	0.23
1/8	3.8	95	5	75707	1.70	25	75907	1.45	10	15707	1.13	100	12907	0.83	10	15907	0.43	100	13907	0.24
9/64	4.0	101	5	75708	1.70	25	75908	1.45	10	15708	1.13	100	12908	0.83	10	15908	0.43	100	13908	0.24
5/32	4.2	107	5	75709	1.76	25	75909	1.50	10	15709	1.17	100	12909	0.87	10	15909	0.49	100	13909	0.28
3/16	4.5	114	5	75710	2.05	25	75910	1.73	10	15710	1.36	100	12910	0.99	10	15910	0.55	100	13910	0.32
7/32	4.9	124	2	75711	2.46	10	75911	2.20	5	15711	1.64	50	12911	1.32	5	15911	0.79	50	13911	0.50
1/4	5.3	133	2	75712	2.69	10	75912	2.42	5	15712	1.89	50	12912	1.55	5	15912	1.05	50	13912	0.70
5/16	6.0	152	2	75713	3.73	10	75913	3.26	5	15713	3.00	50	12913	2.42	5	15913	1.62	50	13913	1.13
3/8	6.8	171	2	75714	4.85	10	75914	4.34	5	15714	4.19	50	12914	3.54	5	15914	2.34	50	13914	1.67
7/16	7.5	191							1	15715	8.67	25	12915	7.49	1	15915	4.93	25	13915	3.65
1/2	8.3	210							1	15716	11.10	25	12916	9.58	1	15916	5.57	25	13916	4.12
9/16	9.0	229							1	15717	13.57	10	12917	11.97	1	15917	7.28	10	13917	5.51
5/8	9.8	248							1	15718	15.17	10	12918	13.38	1	15918	11.45	10	13918	8.66
3/4	11.3	287							1	15719	25.09	5	12919	22.38	1	15919	16.66	5	13919	12.73
See page 32 for larger sizes.																				
Metric Sizes			ProHold® Tip Long Tagged/Barcoded						Balldriver® Tip Long Tagged/Barcoded						Hex Tip Long Tagged/Barcoded					
SIZE	INCH	MM	QTY	PART#	LIST EA	QTY	PART#	LIST EA	QTY	PART#	LIST EA	QTY	PART#	LIST EA	QTY	PART#	LIST EA	QTY	PART#	LIST EA
0.71	2.6	66													10	15947	\$0.55	100	13947	\$0.28
0.89	2.7	68													10	15948	0.55	100	13948	0.28
1.27	2.8	72	5	75749	\$1.38	25	75949	\$1.13	10	15749	\$0.92	100	12949	\$0.63	10	15949	0.31	100	13949	0.14
1.5	3.0	77	5	75750	1.38	25	75950	1.13	10	15750	0.92	100	12950	0.63	10	15950	0.34	100	13950	0.16
2.0	3.2	82	5	75752	1.38	25	75952	1.16	10	15752	0.92	100	12952	0.65	10	15952	0.34	100	13952	0.16
2.5	3.5	88	5	75754	1.47	25	75954	1.25	10	15754	0.98	100	12954	0.70	10	15954	0.41	100	13954	0.23
3.0	3.9	98	5	75756	1.66	25	75956	1.43	10	15756	1.11	100	12956	0.83	10	15956	0.41	100	13956	0.23
3.5	3.9	100							1	15758	1.15	100	12958	0.87	1	15958	0.49	100	13958	0.28
4.0	4.3	109	5	75760	1.76	25	75960	1.50	10	15760	1.17	100	12960	0.87	10	15960	0.49	100	13960	0.28
4.5	4.5	114							1	15762	1.35	100	12962	1.09	1	15962	0.74	100	13962	0.43
5.0	4.7	119	2	75764	2.24	25	75964	1.90	5	15764	1.49	100	12964	1.09	5	15964	0.74	100	13964	0.43
5.5	4.9	124							1	15766	1.74	50	12966	1.37	1	15966	1.05	50	13966	0.70
6	5.5	139	2	75768	2.79	10	75968	2.52	5	15768	1.99	50	12968	1.66	5	15968	1.05	50	13968	0.70
7	5.9	150							1	15770	2.70	50	12970	2.28	1	15970	1.72	50	13970	1.24
8	6.4	162	2	75772	3.91	10	75972	3.43	5	15772	3.19	50	12972	2.60	5	15972	1.72	50	13972	1.24
9	6.9	175							1	15774	3.83	50	12974	3.19	1	15974	2.70	50	13974	1.95
10	7.4	187	2	75776	5.29	10	75976	4.75	5	15776	4.66	50	12976	3.96	5	15976	2.70	50	13976	1.95
11	7.9	200							1	15778	8.58	25	12978	7.40	1	15978	5.81	25	13978	4.35
12	8.7	220							1	15780	10.30	25	12980	8.88	1	15980	5.81	25	13980	4.35
14	10.2	259							1	15784	12.88	10	12984	11.36	1	15984	7.72	10	13984	5.90
17	11.0	280							1	15786	20.41	10	12986	18.00	1	15986	11.03	10	13986	8.44
19	11.6	295							1	15788	24.21	5	12988	21.59	1	15988	15.32	5	13988	11.85
See page 32 for larger sizes.																				

Hex Keys

Balldriver® & Hex Singles with ProGuard™ finish Short & Stubby

Inch Sizes

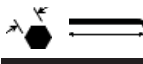

Hex Tip Short			Tagged/Barcoded			Bulk		
SIZE	INCH	MM	QTY	PART#	LIST EA	QTY	PART#	LIST EA
.028	1.2	31	10	15800	\$0.37	100	13800	\$0.19
.035	1.2	31	10	15801	0.37	100	13801	0.19
.050	1.6	42	10	15802	0.27	100	13802	0.11
1/16	1.8	45	10	15803	0.27	100	13803	0.11
5/64	1.9	48	10	15804	0.30	100	13804	0.13
3/32	2.0	51	10	15805	0.30	100	13805	0.13
7/64	2.1	54	10	15806	0.31	100	13806	0.14
1/8	2.3	58	10	15807	0.31	100	13807	0.14
9/64	2.4	61	10	15808	0.34	100	13808	0.16
5/32	2.5	64	10	15809	0.34	100	13809	0.16
3/16	2.8	70	10	15810	0.41	100	13810	0.23
7/32	3.0	77	5	15811	0.57	50	13811	0.33
1/4	3.3	83	5	15812	0.66	50	13812	0.41
5/16	3.8	96	5	15813	1.01	50	13813	0.67
3/8	4.3	108	5	15814	1.47	50	13814	1.02
7/16	4.8	121	1	15815	3.45	50	13815	2.38
1/2	5.3	133	1	15816	4.07	50	13816	2.80
9/16	5.8	146	1	15817	5.58	25	13817	3.94
5/8	6.3	159	1	15818	7.26	20	13818	5.18
3/4	7.3	184	1	15819	11.55	15	13819	8.34

Metric Sizes

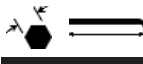

Hex Tip Short			Tagged/Barcoded			Bulk		
SIZE	INCH	MM	QTY	PART#	LIST EA	QTY	PART#	LIST EA
.71	1.2	31	10	15847	\$0.37	100	13847	\$0.19
.89	1.2	31	10	15848	0.37	100	13848	0.19
1.27	1.6	42	10	15849	0.27	100	13849	0.11
1.5	1.7	44	10	15850	0.27	100	13850	0.11
2.0	1.9	49	10	15852	0.30	100	13852	0.13
2.5	2.1	54	10	15854	0.30	100	13854	0.14
3.0	2.4	61	10	15856	0.31	100	13856	0.14
3.5	2.6	65	1	15858	0.34	100	13858	0.16
4.0	2.7	68	10	15860	0.34	100	13860	0.16
4.5	2.9	73	1	15862	0.41	100	13862	0.28
5.0	3.1	78	5	15864	0.41	100	13864	0.28
5.5	3.3	83	1	15866	0.66	50	13866	0.41
6	3.5	88	5	15868	0.66	50	13868	0.41
7	3.7	93	1	15870	1.03	50	13870	0.70
8	3.9	98	5	15872	1.03	50	13872	0.70
9	4.0	102	1	15874	1.72	50	13874	1.24
10	4.3	109	5	15876	1.72	50	13876	1.24
11	4.5	115	1	15878	4.36	50	13878	3.15
12	4.8	122	1	15880	4.36	50	13880	3.15
14	5.4	136	1	15884	5.97	25	13884	4.33
17	6.1	156	1	15886	6.49	20	13886	4.80
19	6.9	175	1	15888	11.02	15	13888	8.16

See page 32 for larger sizes.

See page 32 for larger sizes.

Inch Sizes

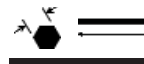

Balldriver® Tip Stubby Long					Tagged/Barcoded			Bulk		
SIZE	INCH	MM	INCH	MM	QTY	PART#	LIST EA	QTY	PART#	LIST EA
.050	2.8	72	.19	5	5	16502	\$1.10	50	26502	\$0.99
1/16	3.0	76	.16	4	5	16503	1.10	50	26503	0.99
5/64	3.2	81	.27	7	5	16504	1.10	50	26504	0.99
3/32	3.4	86	.29	7	5	16505	1.15	50	26505	1.04
7/64	3.6	90	.30	8	5	16506	1.30	50	26506	1.17
1/8	3.8	95	.32	8	5	16507	1.35	50	26507	1.22
9/64	4.0	101	.33	8	5	16508	1.35	50	26508	1.22
5/32	4.2	107	.35	9	5	16509	1.40	50	26509	1.26
3/16	4.5	114	.39	10	5	16510	1.60	50	26510	1.44
7/32	4.9	124	.46	12	2	16511	1.95	25	26511	1.76
1/4	5.3	133	.46	12	2	16512	2.25	25	26512	2.03
5/16	6.0	152	.57	14	2	16513	3.50	25	26513	3.15
3/8	6.8	171	.71	18	2	16514	4.90	25	26514	4.41

Metric Sizes

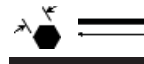

Balldriver® Tip Stubby Long					Tagged/Barcoded			Bulk		
SIZE	INCH	MM	INCH	MM	QTY	PART#	LIST EA	QTY	PART#	LIST EA
1.27	2.8	72	.19	5	5	16549	\$1.10	50	26549	\$0.99
1.5	3.0	77	.25	6	5	16550	1.10	50	26550	0.99
2.0	3.2	82	.27	7	5	16552	1.10	50	26552	0.99
2.5	3.5	88	.28	7	5	16554	1.15	50	26554	1.04
3	3.9	98	.32	8	5	16556	1.35	50	26556	1.22
4	4.3	110	.35	9	5	16560	1.40	50	26560	1.26
5	4.7	119	.40	10	2	16564	1.80	25	26564	1.62
6	5.5	139	.47	12	2	16568	2.35	25	26568	2.12
8	6.4	162	.57	14	2	16572	3.80	25	26572	3.42
10	7.4	187	.72	18	2	16576	5.60	25	26576	5.04

See page 32 for larger sizes.



Hex Keys

Balldriver® & Hex Singles with BriteGuard™ finish Long & Extra Long

Inch Sizes

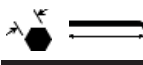

Balldriver® Tip Long
Tagged/Barcoded

SIZE	INCH	MM	Tagged/Barcoded			Bulk		
SIZE	INCH	MM	QTY	PART#	LIST EA	QTY	PART#	LIST EA
.028	2.6	66						
.035	2.7	68						
.050	2.8	72	10	16902	\$1.08	50	26902	\$0.84
1/16	3.0	76	10	16903	1.08	50	26903	0.84
5/64	3.2	81	10	16904	1.08	50	26904	0.84
3/32	3.4	86	10	16905	1.13	50	26905	0.98
7/64	3.6	90	10	16906	1.29	50	26906	1.08
1/8	3.8	95	10	16907	1.34	50	26907	1.18
9/64	4.0	101	10	16908	1.34	50	26908	1.18
5/32	4.2	107	10	16909	1.39	50	26909	1.24
3/16	4.5	114	10	16910	1.60	50	26910	1.39
7/32	4.9	124	5	16911	1.91	25	26911	1.80
1/4	5.3	133	5	16912	2.21	25	26912	2.11
5/16	6.0	152	5	16913	3.50	25	26913	3.35
3/8	6.8	171	5	16914	4.94	25	26914	4.69
7/16	7.5	191	1	16915	9.06			
1/2	8.3	210	1	16916	11.33			
9/16	9.0	229	1	16917	14.42			
5/8	9.8	248	1	16918	16.48			
3/4	11.3	286	1	16919	24.72			

Metric Sizes

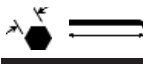

Balldriver® Tip Extra Long
Tagged/Barcoded

SIZE	INCH	MM	Tagged/Barcoded			Bulk		
SIZE	INCH	MM	QTY	PART#	LIST EA	QTY	PART#	LIST EA
.71	2.6	66						
.89	2.7	68						
1.27	2.8	72	10	17049	\$1.08	50	27049	\$0.84
1.5	3.5	90	10	17050	1.08	50	27050	0.84
2.0	3.9	100	10	17052	1.08	50	27052	0.84
2.5	4.4	112	10	17054	1.13	50	27054	0.98
3.0	5.0	126	10	17056	1.29	50	27056	1.08
3.5	5.2	133	1	17058	1.39	50	27058	1.24
4.0	5.6	142	10	17060	1.39	50	27060	1.24
4.5	5.9	151	1	17062	1.60	50	27062	1.39
5.0	6.3	160	5	17064	1.75	50	27064	1.55
5.5	6.8	172	1	17066	2.06	25	27066	1.96
6	6.8	172	5	17068	2.32	25	27068	2.16
7	7.2	184	1	17070	3.14	25	27070	2.99
8	7.7	195	5	17072	3.76	25	27072	3.55
9	8.2	209	1	17074	4.48	25	27074	4.38
10	8.8	224	5	17076	5.46	10	27076	5.36
11	7.9	200	1	17078	9.06	10	27078	8.86
12	8.7	220	1	17080	9.06	10	27080	8.86
14	10.2	260	1	17084	12.88			
17	11.0	280	1	17086	19.57			
19	11.6	295	1	17088	24.72			

Inch Sizes



Hex Tip Long
Tagged/Barcoded

SIZE	INCH	MM	Tagged/Barcoded			Bulk		
SIZE	INCH	MM	QTY	PART#	LIST EA	QTY	PART#	LIST EA
.028	2.6	66	10	16100	\$0.72	50	26100	\$0.41
.035	2.7	68	10	16101	0.72	50	26101	0.41
.050	2.8	72	10	16102	0.43	50	26102	0.28
1/16	3.0	76	10	16103	0.46	50	26103	0.31
5/64	3.2	81	10	16104	0.46	50	26104	0.31
3/32	3.4	86	10	16105	0.57	50	26105	0.40
7/64	3.6	90	10	16106	0.57	50	26106	0.40
1/8	3.8	95	10	16107	0.57	50	26107	0.40
9/64	4.0	101	10	16108	0.67	50	26108	0.46
5/32	4.2	107	10	16109	0.67	50	26109	0.46
3/16	4.5	114	10	16110	0.98	50	26110	0.72
7/32	4.9	124	5	16111	1.39	25	26111	1.18
1/4	5.3	133	5	16112	1.39	25	26112	1.18
5/16	6.0	152	5	16113	2.32	25	26113	2.06
3/8	6.8	171	5	16114	3.61	25	26114	3.24
7/16	7.5	191	1	16115	7.42			
1/2	8.3	210	1	16116	7.42			
9/16	9.0	229	1	16117	8.24			
5/8	9.8	248	1	16118	11.85			
3/4	11.3	286	1	16119	15.97			

Metric Sizes

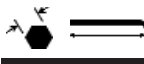

Hex Tip Extra Long
Tagged/Barcoded

SIZE	INCH	MM	Tagged/Barcoded			Bulk		
SIZE	INCH	MM	QTY	PART#	LIST EA	QTY	PART#	LIST EA
.71	2.6	66	10	17147	\$0.72	50	27147	\$0.41
.89	2.7	68	10	17148	0.72	50	27148	0.41
1.27	2.8	72	10	17149	0.43	50	27149	0.28
1.5	3.5	90	10	17150	0.46	50	27150	0.31
2.0	3.9	100	10	17152	0.46	50	27152	0.31
2.5	4.4	112	10	17154	0.57	50	27154	0.40
3.0	5.0	126	10	17156	0.57	50	27156	0.40
3.5	5.2	133	1	17158	0.67	50	27158	0.46
4.0	5.6	142	10	17160	0.67	50	27160	0.46
4.5	5.9	151	1	17162	0.98	50	27162	0.72
5.0	6.3	160	5	17164	0.98	50	27164	0.72
5.5	6.8	172	1	17166	1.39	25	27166	1.18
6	6.8	172	5	17168	1.39	25	27168	1.18
7	7.2	184	1	17170	2.32	25	27170	2.06
8	7.7	195	5	17172	2.32	25	27172	2.06
9	8.2	209	1	17174	3.61	25	27174	3.24
10	8.8	224	5	17176	3.61	10	27176	3.24
11	7.9	200	1	17178	7.42	10	27178	7.26
12	8.7	220	1	17180	7.42	10	27180	7.26
14	10.2	260	1	17184	8.24			
17	11.0	280	1	17186	11.33			
19	11.6	295	1	17188	14.94			

Hex Keys

Balldriver® & Hex Singles with BriteGuard™ finish Short & Stubby

Inch Sizes

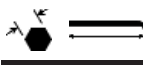

Hex Tip Short			Tagged/Barcoded			Bulk		
SIZE	INCH	MM	QTY	PART#	LIST EA	QTY	PART#	LIST EA
.028	1.2	31	10	16200	\$0.52	50	26200	\$0.31
.035	1.2	31	10	16201	0.52	50	26201	0.31
.050	1.6	42	10	16202	0.36	50	26202	0.21
1/16	1.8	45	10	16203	0.36	50	26203	0.21
5/64	1.9	48	10	16204	0.41	50	26204	0.24
3/32	2.0	51	10	16205	0.41	50	26205	0.24
7/64	2.1	54	10	16206	0.43	50	26206	0.29
1/8	2.3	58	10	16207	0.43	50	26207	0.29
9/64	2.4	61	10	16208	0.46	50	26208	0.31
5/32	2.5	64	10	16209	0.46	50	26209	0.31
3/16	2.8	70	10	16210	0.57	50	26210	0.46
7/32	3.0	77	5	16211	0.88	25	26211	0.74
1/4	3.3	83	5	16212	0.88	25	26212	0.74
5/16	3.8	96	5	16213	1.39	25	26213	1.18
3/8	4.3	108	5	16214	2.32	25	26214	2.06
7/16	4.8	121	1	16215	4.74			
1/2	5.3	133	1	16216	4.74			
9/16	5.8	146	1	16217	5.97			
5/8	6.3	159	1	16218	7.73			
3/4	7.3	184	1	16219	11.95			

Metric Sizes

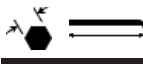

Hex Tip Short			Tagged/Barcoded			Bulk		
SIZE	INCH	MM	QTY	PART#	LIST EA	QTY	PART#	LIST EA
.71	1.2	31	10	16247	\$0.52	50	26247	\$0.31
.89	1.2	31	10	16248	0.52	50	26248	0.31
1.27	1.6	42	10	16249	0.36	50	26249	0.21
1.5	1.7	44	10	16250	0.36	50	26250	0.21
2.0	1.9	49	10	16252	0.39	50	26252	0.24
2.5	2.1	54	10	16254	0.39	50	26254	0.24
3.0	2.4	61	10	16256	0.43	50	26256	0.29
3.5	2.6	65	1	16258	0.46	50	26258	0.31
4.0	2.7	68	10	16260	0.46	50	26260	0.31
4.5	2.9	73	1	16262	0.57	50	26262	0.46
5.0	3.1	78	5	16264	0.57	50	26264	0.46
5.5	3.3	83	1	16266	0.88	25	26266	0.74
6	3.5	88	5	16268	0.88	25	26268	0.74
7	3.7	93	1	16270	1.39	25	26270	1.18
8	3.9	98	5	16272	1.39	25	26272	1.18
9	4.0	102	1	16274	2.32	25	26274	2.06
10	4.3	109	5	16276	2.32	10	26276	2.06
11	4.5	115	1	16278	4.74	10	26278	4.43
12	4.8	122	1	16280	4.74	10	26280	4.43
14	5.4	136	1	16284	6.18			
17	6.1	154	1	16286	7.21			
19	6.9	175	1	16288	11.95			

Inch Sizes



Balldriver® Tip Stubby Long					Tagged/Barcoded			Bulk		
SIZE	INCH	MM	INCH	MM	QTY	PART#	LIST EA	QTY	PART#	LIST EA
.050	2.8	72	.19	5	5	16702	\$1.39	50	26702	\$1.26
1/16	3.0	76	.16	4	5	16703	1.39	50	26703	1.26
5/64	3.2	81	.27	7	5	16704	1.39	50	26704	1.26
3/32	3.4	86	.29	7	5	16705	1.44	50	26705	1.30
7/64	3.6	90	.30	8	5	16706	1.65	50	26706	1.48
1/8	3.8	95	.32	8	5	16707	1.70	50	26707	1.53
9/64	4.0	101	.33	8	5	16708	1.70	50	26708	1.53
5/32	4.2	107	.35	9	5	16709	1.75	50	26709	1.58
3/16	4.5	114	.39	10	5	16710	2.01	50	26710	1.81
7/32	4.9	124	.46	12	2	16711	2.42	25	26711	2.18
1/4	5.3	133	.46	12	2	16712	2.83	25	26712	2.55
5/16	6.0	152	.57	14	2	16713	4.38	25	26713	3.94
3/8	6.8	171	.71	18	2	16714	6.18	25	26714	5.56

Metric Sizes

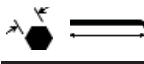

Balldriver® Tip Stubby Extra Long					Tagged/Barcoded			Bulk		
SIZE	INCH	MM	INCH	MM	QTY	PART#	LIST EA	QTY	PART#	LIST EA
1.27	2.8	72	.19	5	5	16749	\$1.39	50	26749	\$1.26
1.5	3.5	90	.25	6	5	16750	1.39	50	26750	1.26
2.0	3.9	100	.27	7	5	16752	1.39	50	26752	1.26
2.5	4.4	112	.28	7	5	16754	1.44	50	26754	1.30
3	5.0	126	.32	8	5	16756	1.65	50	26756	1.48
4	5.6	142	.35	9	5	16760	1.75	50	26760	1.58
5	6.3	160	.40	10	2	16764	2.21	25	26764	2.00
6	6.8	172	.47	12	2	16768	2.94	25	26768	2.65
8	7.7	195	.57	14	2	16772	4.79	25	26772	4.32
10	8.8	224	.72	18	2	16776	6.95	25	26776	6.26

Hex Keys

Hex Singles with GoldGuard™ finish Long & Short Singles

Inch Sizes

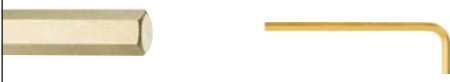

Hex Tip Long
Tagged/Barcoded

SIZE	INCH	MM	QTY	PART#	LIST EA	QTY	PART#	LIST EA
.028	2.6	66	10	38100	\$0.72	50	28100	\$0.41
.035	2.7	68	10	38101	0.72	50	28101	0.41
.050	2.8	72	10	38102	0.43	50	28102	0.28
1/16	3.0	76	10	38103	0.46	50	28103	0.31
5/64	3.2	81	10	38104	0.46	50	28104	0.31
3/32	3.4	86	10	38105	0.57	50	28105	0.40
7/64	3.6	90	10	38106	0.57	50	28106	0.40
1/8	3.8	95	10	38107	0.57	50	28107	0.40
9/64	4.0	101	10	38108	0.67	50	28108	0.46
5/32	4.2	107	10	38109	0.67	50	28109	0.46
3/16	4.5	114	10	38110	0.98	50	28110	0.72
7/32	4.9	124	5	38111	1.39	25	28111	1.18
1/4	5.3	133	5	38112	1.39	25	28112	1.18
5/16	6.0	152	5	38113	2.32	25	28113	2.06
3/8	6.8	171	5	38114	3.61	25	28114	3.24
7/16	7.5	191	1	38115	7.42			
1/2	8.3	210	1	38116	7.42			
9/16	9.0	229	1	38117	8.24			
5/8	9.8	248	1	38118	11.85			
3/4	11.3	286	1	38119	15.97			

Metric Sizes



Hex Tip Long
Tagged/Barcoded

SIZE	INCH	MM	QTY	PART#	LIST EA	QTY	PART#	LIST EA
.71	2.6	66	10	39147	\$0.72	50	29147	\$0.41
.89	2.7	68	10	39148	0.72	50	29148	0.41
1.27	2.8	72	10	39149	0.43	50	29149	0.28
1.5	3.0	77	10	39150	0.46	50	29150	0.31
2.0	3.2	82	10	39152	0.46	50	29152	0.31
2.5	3.5	88	10	39154	0.57	50	29154	0.40
3.0	3.9	98	10	39156	0.57	50	29156	0.40
3.5	3.9	100	1	39158	0.67	50	29158	0.46
4.0	4.3	109	10	39160	0.67	50	29160	0.46
4.5	4.5	114	1	39162	0.98	50	29162	0.72
5.0	4.7	119	5	39164	0.98	50	29164	0.72
5.5	4.9	124	1	39166	1.39	25	29166	1.18
6	5.5	139	5	39168	1.39	25	29168	1.18
7	5.9	150	1	39170	2.32	25	29170	2.06
8	6.4	162	5	39172	2.32	25	29172	2.06
9	6.9	175	1	39174	3.61	25	29174	3.24
10	7.4	187	5	39176	3.61	10	29176	3.24
11	7.9	200	1	39178	7.42	10	29178	7.26
12	8.7	220	1	39180	7.42	10	29180	7.26
14	10.2	260	1	39184	8.24			
17	11.0	280	1	39186	11.33			
19	11.6	295	1	39188	14.94			

Inch Sizes



Hex Tip Short
Tagged/Barcoded

SIZE	INCH	MM	QTY	PART#	LIST EA	QTY	PART#	LIST EA
.028	1.2	31	10	38200	\$0.52	50	28200	\$0.31
.035	1.2	31	10	38201	0.52	50	28201	0.31
.050	1.6	42	10	38202	0.36	50	28202	0.21
1/16	1.8	45	10	38203	0.36	50	28203	0.21
5/64	1.9	48	10	38204	0.41	50	28204	0.24
3/32	2.0	51	10	38205	0.41	50	28205	0.24
7/64	2.1	54	10	38206	0.43	50	28206	0.29
1/8	2.3	58	10	38207	0.43	50	28207	0.29
9/64	2.4	61	10	38208	0.46	50	28208	0.31
5/32	2.5	64	10	38209	0.46	50	28209	0.31
3/16	2.8	70	10	38210	0.57	50	28210	0.46
7/32	3.0	77	5	38211	0.88	25	28211	0.74
1/4	3.3	83	5	38212	0.88	25	28212	0.74
5/16	3.8	96	5	38213	1.39	25	28213	1.18
3/8	4.3	108	5	38214	2.32	25	28214	2.06
7/16	4.8	121	1	38215	4.74			
1/2	5.3	133	1	38216	4.74			
9/16	5.8	146	1	38217	5.97			
5/8	6.3	159	1	38218	7.73			
3/4	7.3	184	1	38219	11.95			

Metric Sizes



Hex Tip Short
Tagged/Barcoded

SIZE	INCH	MM	QTY	PART#	LIST EA	QTY	PART#	LIST EA
.71	1.2	31	10	38247	\$0.52	50	28247	\$0.31
.89	1.2	31	10	38248	0.52	50	28248	0.31
1.27	1.6	42	10	38249	0.36	50	28249	0.21
1.5	1.7	44	10	38250	0.36	50	28250	0.21
2.0	1.9	48	10	38252	0.39	50	28252	0.24
2.5	2.1	54	10	38254	0.39	50	28254	0.24
3.0	2.4	61	10	38256	0.43	50	28256	0.29
3.5	2.6	65	1	38258	0.46	50	28258	0.31
4.0	2.7	68	10	38260	0.46	50	28260	0.31
4.5	2.9	73	1	38262	0.57	50	28262	0.46
5.0	3.1	78	5	38264	0.57	50	28264	0.46
5.5	3.3	83	1	38266	0.88	25	28266	0.74
6	3.5	88	5	38268	0.88	25	28268	0.74
7	3.7	93	1	38270	1.39	25	28270	1.18
8	3.9	98	5	38272	1.39	25	28272	1.18
9	4.0	102	1	38274	2.32	25	28274	2.06
10	4.3	109	5	38276	2.32	10	28276	2.06
11	4.5	115	1	38278	4.74	10	28278	4.43
12	4.8	122	1	38280	4.74	10	28280	4.43
14	5.4	136	1	38284	6.18			
17	6.1	156	1	38286	7.21			
19	6.9	175	1	38288	11.95			

Hex Keys

Balldriver® Singles with GoldGuard™ finish Long

Inch Sizes

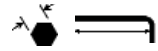

Balldriver® Tip

Long
Tagged/Barcoded

Bulk

SIZE	INCH	MM	QTY	PART#	LIST EA	QTY	PART#	LIST EA
.050	2.8	72	10	37902	\$1.08	50	27902	\$0.86
1/16	3.0	76	10	37903	1.08	50	27903	0.86
5/64	3.2	81	10	37904	1.08	50	27904	0.86
3/32	3.4	86	10	37905	1.13	50	27905	1.00
7/64	3.6	90	10	37906	1.29	50	27906	1.10
1/8	3.8	95	10	37907	1.34	50	27907	1.21
9/64	4.0	101	10	37908	1.34	50	27908	1.21
5/32	4.2	107	10	37909	1.39	50	27909	1.26
3/16	4.5	114	10	37910	1.60	50	27910	1.42
7/32	4.9	124	5	37911	1.91	25	27911	1.84
1/4	5.3	133	5	37912	2.21	25	27912	2.15
5/16	6.0	152	5	37913	3.50	25	27913	3.41
3/8	6.8	171	5	37914	4.94	25	27914	4.78
7/16	7.5	191	1	37915	9.06			
1/2	8.3	210	1	37916	11.33			
9/16	9.0	229	1	37917	14.42			
5/8	9.8	248	1	37918	16.48			
3/4	11.3	286	1	37919	24.72			

Metric Sizes

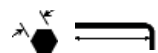

Balldriver® Tip

Long
Tagged/Barcoded

Bulk

SIZE	INCH	MM	QTY	PART#	LIST EA	QTY	PART#	LIST EA
1.27	2.8	72	10	38049	\$1.08	50	28049	\$0.86
1.5	3.0	77	10	38050	1.08	50	28050	0.86
2.0	3.2	82	10	38052	1.08	50	28052	0.86
2.5	3.5	88	10	38054	1.13	50	28054	1.00
3.0	3.9	98	10	38056	1.29	50	28056	1.10
3.5	3.9	100	1	38058	1.39	50	28058	1.26
4.0	4.3	109	10	38060	1.39	50	28060	1.26
4.5	4.5	114	1	38062	1.60	50	28062	1.42
5.0	4.7	119	5	38064	1.75	50	28064	1.58
5.5	4.9	124	1	38066	2.06	25	28066	2.00
6	5.5	139	5	38068	2.32	25	28068	2.21
7	5.9	150	1	38070	3.14	25	28070	3.05
8	6.4	162	5	38072	3.76	25	28072	3.62
9	6.9	175	1	38074	4.48	25	28074	4.46
10	7.4	187	5	38076	5.46	10	28076	5.46
11	7.9	200	1	38078	9.06	10	28078	9.03
12	8.7	220	1	38080	9.06	10	28080	9.03
14	10.2	260	1	38084	12.88			
17	11.0	280	1	38086	19.57			
19	11.6	295	1	38088	24.72			



Bondhex™ cases provide a convenient means of keeping hex keys neat and organized. Sizes are printed on the case and allow identification at a glance.

Cases are color coded yellow for inch, red for metric, and green for Star tools. Case can be used in conjunction with the tool to increase torque.

Inch Sizes

SIZE	QTY	PART#	DESC	LIST EA
.050 – 5/32	10	18032	Holds 8 Tools	\$0.90
.050 – 5/16	10	18036	Holds 12 Tools	1.10
.050 – 3/8	10	18037	Holds 13 Tools	1.35
1/16 – 1/4	10	18038	Holds 10 Tools	1.10
5/64 – 3/16	10	18045	Holds 7 Tools	0.90

Metric Sizes

SIZE	QTY	PART#	DESC	LIST EA
1.5 – 5mm	10	18046	Holds 6 Tools	\$0.90
1.5 – 10mm	10	18099	Holds 9 Tools	1.10



T-Handle Stands

PART#	QTY	DESCRIPTION	LIST EA
17936	1	Inch Molded T-Handle Stand	\$3.25
17935	1	Metric Molded T-Handle Stand	3.25
17934	1	Star Molded T-Handle Stand	3.25





Set stand on bench or mount on wall.

Hex Keys



Balldriver® & Hex Singles with ProGuard™ finish Packaged Quantities Long & Short

Inch Sizes

Balldriver® Tip Long				Hex Tip Long			
SIZE	INCH	MM	QTY	PART#	LIST EA	PART#	LIST EA
.028	2.6	66	10			12100	\$0.45
.035	2.7	68	10			12101	0.45
.050	2.8	72	10	10902	\$0.86	12102	0.27
1/16	3.0	76	10	10903	0.86	12103	0.29
5/64	3.2	81	10	10904	0.86	12104	0.29
3/32	3.4	86	10	10905	0.89	12105	0.29
7/64	3.6	90	10	10906	1.00	12106	0.35
1/8	3.8	95	10	10907	1.05	12107	0.37
9/64	4.0	101	10	10908	1.05	12108	0.37
5/32	4.2	107	10	10909	1.09	12109	0.41
3/16	4.5	114	10	10910	1.26	12110	0.45
7/32	4.9	124	5	10911	1.52	12111	0.66
1/4	5.3	133	5	10912	1.75	12112	0.89
5/16	6.0	152	5	10913	2.77	12113	1.36
3/8	6.8	171	5	10914	3.89	12114	1.96
7/16	7.5	191	1	10915	8.05	12115	4.14
1/2	8.3	210	1	10916	10.31	12116	4.68
9/16	9.0	229	1	10917	12.61	12117	6.12
5/8	9.8	248	1	10918	14.09	12118	9.62
3/4	11.3	287	1	10919	23.31	12119	13.99
7/8	12.8	325	1			12120	23.69
1	14.2	362	1			12121	32.45
1 1/4	17.1	435	1			12125	129.00
1 1/2	20.4	518	1			12129	206.00

Metric Sizes

Balldriver® Tip Long				Hex Tip Long			
SIZE	INCH	MM	QTY	PART#	LIST EA	PART#	LIST EA
.71	2.6	66	10			12147	\$0.45
.89	2.7	68	10			12148	0.45
1.27	2.8	72	10	10949	\$0.86	12149	0.27
1.5	3.0	77	10	10950	0.86	12150	0.29
2.0	3.2	82	10	10952	0.86	12152	0.29
2.5	3.5	88	10	10954	0.91	12154	0.35
3.0	3.9	98	10	10956	1.02	12156	0.35
3.5	3.9	100	1	10958	1.07	12158	0.41
4.0	4.3	109	10	10960	1.09	12160	0.41
4.5	4.5	114	1	10962	1.25	12162	0.62
5.0	4.7	119	5	10964	1.39	12164	0.62
5.5	4.9	124	1	10966	1.61	12166	0.89
6	5.5	139	5	10968	1.85	12168	0.89
7	5.9	150	1	10970	2.50	12170	1.44
8	6.4	162	5	10972	2.96	12172	1.44
9	6.9	175	1	10974	3.55	12174	2.27
10	7.4	187	5	10976	4.33	12176	2.27
11	7.9	200	1	10978	7.97	12178	4.88
12	8.7	220	1	10980	9.56	12180	4.88
14	10.2	259	1	10984	11.95	12184	6.49
17	11.0	280	1	10986	18.96	12186	9.27
19	11.6	295	1	10988	22.49	12188	12.88
22	13.0	330	1			12191	24.20
24	14.5	370	1			12193	33.99
27	—	—	—			—	—
32	17.1	435	1			12196	132.87
36	20.5	520	1			12198	216.30

Inch Sizes

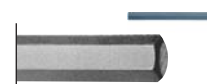

Hex Tip Short				Hex Tip Short			
SIZE	INCH	MM	QTY	PART#	LIST EA	PART#	LIST EA
.028	1.2	31	10	12200	\$0.31		
.035	1.2	31	10	12201	0.31		
.050	1.6	42	10	12202	0.23		
1/16	1.8	45	10	12203	0.23		
5/64	1.9	48	10	12204	0.25		
3/32	2.0	51	10	12205	0.25		
7/64	2.1	54	10	12206	0.27		
1/8	2.3	58	10	12207	0.27		
9/64	2.4	61	10	12208	0.29		
5/32	2.5	64	10	12209	0.29		
3/16	2.8	70	10	12210	0.35		
7/32	3.0	77	5	12211	0.47		
1/4	3.3	83	5	12212	0.56		
5/16	3.8	96	5	12213	0.84		
3/8	4.3	108	5	12214	1.24		
7/16	4.8	121	1	12215	2.90		
1/2	5.3	133	1	12216	3.42		
9/16	5.8	146	1	12217	4.70		
5/8	6.3	159	1	12218	6.10		
3/4	7.3	184	1	12219	9.70		
7/8	8.2	210	1	12220	15.45		
1	9.2	235	1	12221	22.66		
1 1/4	11.2	286	1	12225	64.90		
1 1/2	13.2	336	1	12229	81.10		
1 3/4	13.5	343	1	12231	155.00		
2	15.3	387	1	12233	208.05		

Metric Sizes



Hex Tip Short				Hex Tip Short			
SIZE	INCH	MM	QTY	PART#	LIST EA	PART#	LIST EA
.71	1.2	31	10	12247	\$0.31		
.89	1.2	31	10	12248	0.31		
1.27	1.6	42	10	12249	0.23		
1.5	1.7	44	10	12250	0.23		
2.0	1.9	49	10	12252	0.25		
2.5	2.1	54	10	12254	0.25		
3.0	2.4	61	10	12256	0.27		
3.5	2.6	65	1	12258	0.29		
4.0	2.7	68	10	12260	0.29		
4.5	2.9	73	1	12262	0.35		
5.0	3.1	78	5	12264	0.35		
5.5	3.3	83	1	12266	0.56		
6	3.5	88	5	12268	0.56		
7	3.7	93	1	12270	0.88		
8	3.9	98	5	12272	0.88		
9	4.0	102	1	12274	1.44		
10	4.3	109	5	12276	1.44		
11	4.5	115	1	12278	3.67		
12	4.8	122	1	12280	3.67		
14	5.4	136	1	12284	5.03		
17	6.1	156	1	12286	5.46		
19	6.9	175	1	12288	9.27		
22	7.7	195	1	12291	21.63		
24	8.6	219	1	12293	27.05		
27	9.6	244	1	12295	54.10		
32	12.1	307	1	12296	64.90		
36	13.6	346	1	12298	81.10		

Star hex keys

Hex Key Sets with ProGuard™ finish



★	ProHold® Star Tip				BallStar™ Tip			Star Tip			Tamper-Resistant Tip			
	SIZE	PCS	PART#	MODEL #	LIST EA	PART#	MODEL #	LIST EA	PART#	MODEL #	LIST EA	PART#	MODEL #	LIST EA
	Long Arm:													
	T6 – T25	8				11331	LTX8S	\$37.25	31832	TLX8S	\$16.35	32432	TR-TL8S	\$25.00
	T9 – T40	8	71834	PHTX8	\$21.25	11332	LTX8	41.91	31834	TLX8	14.10	32434	TR-TL8	21.35
	T6 – T15	6				11346	LTX6	26.88						
	Short Arm:													
	T6 – T25	8							31732	TLXS8S	14.20			
	T9 – T40	8							31734	TLXS8	12.30			

Star Hex Key Singles

★	ProHold® Star Tip				BallStar™ Tip			Star Tip			Tamper-Resistant Tip			Star Tip Short							
	SIZE	INCH	MM	QTY	PART#	LIST EA	QTY	PART#	LIST EA	QTY	PART#	LIST EA	QTY	PART#	LIST EA	SIZE	INCH	MM	QTY	PART#	LIST EA
	Tagged/Barcoded																				
	T5						5	11706	\$4.34	5	31806	\$2.90	2	32406	\$4.35	T5	0.9	23	5	31705	\$2.50
	T6	2.1	55				5	11707	4.34	5	31807	2.60	2	32407	4.00	T6	1.1	29	5	31706	2.50
	T7	2.4	61				5	11708	4.34	5	31808	2.60	2	32408	4.00	T7	1.4	35	5	31707	2.25
	T8	2.6	67				5	11709	4.34	5	31809	2.60	2	32409	4.00	T8	1.6	42	5	31708	2.25
	T9	2.9	74	5	71809	\$3.90	5	11710	4.34	5	31810	1.45	2	32410	2.20	T9	1.9	48	5	31709	2.25
	T10	3.2	80	5	71810	2.20	5	11711	4.68	5	31811	1.50	2	32411	2.30	T10	2.2	55	5	31710	1.25
	T15	3.3	84	5	71815	2.25	5	11712	4.85	5	31812	1.55	2	32412	2.40	T15	2.3	59	5	31715	1.30
	T20	3.6	91	5	71820	2.35	5	11713	5.00	5	31813	1.65	2	32413	2.50	T20	2.6	66	5	31720	1.40
	T25	3.8	98	5	71825	2.50	5	11714	5.37	5	31814	1.70	2	32414	2.60	T25	2.8	72	5	31725	1.45
	T27	4.2	106	5	71827	2.55	5	11715	5.54	5	31815	1.90	2	32415	2.85	T27	3.2	81	5	31727	1.50
	T30	4.6	116	5	71830	2.85	5	11716	5.71	5	31816	2.05	2	32416	2.95	T30	3.6	90	5	31730	1.60
	T40	4.9	125	5	71840	3.10	5	11717	6.40	5	31817	2.80				T40	3.9	99	5	31740	1.80
	T45	5.4	138	2	71845	4.20	1	11718	7.62	2	31845	3.50				T45	3.9	98	2	31745	2.20
	T50	6.2	156	2	71850	5.25	1	11719	8.49	2	31850	5.25				T50	3.8	97	2	31750	2.50
	T55	6.7	171	2	71855	7.90	1	11720	11.45	2	31855	6.90				T55	3.8	95	2	31755	4.25
	T60	7.2	182	2	71860	10.35				2	31860					T60	3.7	93	2	31760	6.00
	Bulk																				
	T5						25	32806	\$2.60	25	33406	\$3.90				T5	0.9	23	25	32705	\$2.25
	T6	2.1	55				25	32807	2.35	25	33407	3.60				T6	1.1	29	25	32706	2.25
	T7	2.4	61				25	32808	2.35	25	33408	3.60				T7	1.4	35	25	32707	2.00
	T8	2.6	67				25	32809	2.35	25	33409	3.60				T8	1.6	42	25	32708	2.00
	T9	2.9	74	25	72809	\$3.50	25	32810	1.10	25	33410	1.90				T9	1.9	48	25	32709	2.00
	T10	3.2	80	25	72810	1.75	25	32811	1.20	25	33411	1.95				T10	2.2	55	25	32710	1.15
	T15	3.3	84	25	72815	2.00	25	32812	1.30	25	33412	2.05				T15	2.3	59	25	32715	1.15
	T20	3.6	91	25	72820	2.10	25	32813	1.50	25	33413	2.15				T20	2.6	66	25	32720	1.25
	T25	3.8	98	25	72825	2.25	25	32814	1.70	25	33414	2.35				T25	2.8	72	25	32725	1.30
	T27	4.2	106	25	72827	2.30	25	32815	1.85	25	33415	2.50				T27	3.2	81	25	32727	1.35
	T30	4.6	116	25	72830	2.55	25	32816	2.00	25	33416	2.70				T30	3.6	90	25	32730	1.45
	T40	4.9	125	25	72840	2.80	25	32817	2.15	25	33417	2.90				T40	3.9	99	25	32740	1.60
	T45	5.4	138	10	72845	3.80	10	32845	2.35	10	33445	2.50				T45	3.9	98	10	32745	2.00
	T50	6.2	156	10	72850	4.75	10	32850	2.85							T50	3.8	97	10	32750	2.25
	T55	6.7	171	10	72855	7.10	10	32855	4.60							T55	3.8	95	10	32755	3.85
	T60	7.2	182	10	72860	9.30	10	32860	6.10							T60	3.7	93	10	32760	5.40



Screwdriver Tools

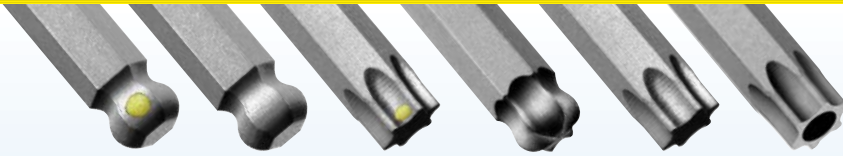

- The ComfortGrip two component handle:
- A tough thermoplastic core for strength and resistance to splitting
 - Molded-on rubber coating for superior grip
 - Handle shape prevents rolling on surfaces angled up to 15°
 - Available in very small sizes for delicate tasks (0.050", 1.27mm, T5)
 - Much faster than ball end hex keys in assembly and frequent use applications



Bondhus handles are designed and sized to match the torque capacity of each blade tip.



Ergonomically designed handles deliver maximum torque with unrivaled comfort and grip



Slight texture of handles helps retain grip, even when hands are wet or oily

Color Coded

- Inch
- Metric
- Star



- High Torque Steel:**
- Up to 20% stronger, with more torque and twice the wear resistance of standard grades of steel.



- Corrosion-resistant finish:**
- Environmentally safe, provides better tool grip, resists solvents and is 5 times more corrosion resistant than competitor finishes.

Screwdriver Sets

Ball End Sets

Inch Sizes

SIZE	PCS	ProHold® Tip ProGuard™ finish			Balldriver® Tip ProGuard™ finish			Balldriver® Tip GoldGuard™ finish			Balldriver® Tip BriteGuard™ finish		
		PART#	MODEL #	LIST EA	PART#	MODEL #	LIST EA	PART#	MODEL #	LIST EA	PART#	MODEL #	LIST EA
.050 – 5/32	8	74632	PBSX8S	\$24.40	10632	BSX8S	\$20.60	38632	BSX8SG	\$26.80	16632	BSX8SB	\$26.80
.050 – 3/8	13	74637	PBSX13	57.05	10637	BSX13	49.55	38637	BSX13G	64.85	16637	BSX13B	64.85
5/64 – 3/16	7				10645	BSX7	20.40						
5/64 – 3/8	11				10737	BSX11L	54.40						
7/64 – 5/16	8				10633	BSX8	33.40						

Metric Sizes

SIZE	PCS	ProHold® Tip ProGuard™ finish			Balldriver® Tip ProGuard™ finish			Balldriver® Tip GoldGuard™ finish			Balldriver® Tip BriteGuard™ finish		
		PART#	MODEL #	LIST EA	PART#	MODEL #	LIST EA	PART#	MODEL #	LIST EA	PART#	MODEL #	LIST EA
1.27 – 5mm	7				10687	BSX7M	\$19.80						
1.5 – 5mm	6	74686	PBSX6M	\$20.75	10686	BSX6M	17.75	38686	BSX6MG	\$24.75	16686	BSX6MB	\$24.75
1.5 – 10mm	9	74699	PBSX9M	45.20	10699	BSX9M	39.05	38699	BSX9MG	53.55	16699	BSX9MB	53.55
2 – 10mm	8				10733	BSX8ML	44.50						

Square Ball Set with ProGuard™ finish



Square Ball



SIZE	PCS	PART#	MODEL #	LIST EA
#0 – #3	4	11640	BRX4	\$19.30

Star Sets with ProGuard™ finish

SIZE	PCS	ProHold® Tip			Ballstar™ Tip			Star Tip			Tamper-Resistant Tip		
		PART#	MODEL #	LIST EA	PART#	MODEL #	LIST EA	PART#	MODEL #	LIST EA	PART#	MODEL #	LIST EA
T6 – T25	8							34532	TSX8S	\$34.40	33832	TR-SX8S	\$57.00
T6 – T15	6				13546	STX6	\$38.05						
T9 – T40	8	75534	PHTSX8	\$70.00	13532	STX8	56.46	34534	TSX8	39.99	33834	TR-SX8	73.00

Screwdriver Singles

ProHold® & Balldriver® Tip Singles

Inch Sizes





SIZE	QTY	INCH	MM	ProHold® Tip ProGuard™ finish		Balldriver® Tip ProGuard™ finish		Balldriver® Tip BriteGuard™ finish		Balldriver® Tip GoldGuard™ finish	
				PART#	LIST EA	PART#	LIST EA	PART#	LIST EA	PART#	LIST EA
.050	2	2.4	60	74602	\$2.47	10602	\$2.03	16602	\$2.83	38602	\$2.83
1/16	2	2.5	64	74603	2.62	10603	2.18	16603	3.09	38603	3.09
5/64	2	2.6	67	74604	2.80	10604	2.37	16604	3.50	38604	3.50
3/32	2	2.8	71	74605	2.93	10605	2.49	16605	3.50	38605	3.50
7/64	2	2.9	74	74606	3.02	10606	2.51	16606	3.61	38606	3.61
1/8	2	3.1	80	74607	3.09	10607	2.55	16607	3.61	38607	3.61
9/64	2	3.3	83	74608	3.31	10608	2.78	16608	4.33	38608	4.33
5/32	2	3.6	91	74609	3.50	10609	2.97	16609	4.33	38609	4.33
3/16	2	3.7	94	74610	4.54	10610	3.94	16610	5.67	38610	5.67
7/32	2	4.2	107	74611	4.97	10611	4.22	16611	6.49	38611	6.49
1/4	2	5.0	126	74612	6.05	10612	5.35	16612	6.49	38612	6.49
5/16	2	5.6	142	74613	6.99	10613	6.34	16613	9.89	38613	9.89
3/8	2	6.5	164	74614	8.20	10614	7.62	16614	11.43	38614	11.43
7/16	1	7.6	194			10615	15.83	16615	20.70	38615	20.70
1/2	1	8.6	217			10616	18.57	16616	24.20	38616	24.20

Metric Sizes





SIZE	QTY	INCH	MM	ProHold® Tip ProGuard™ finish		Balldriver® Tip ProGuard™ finish		Balldriver® Tip BriteGuard™ finish		Balldriver® Tip GoldGuard™ finish	
				PART#	LIST EA	PART#	LIST EA	PART#	LIST EA	PART#	LIST EA
1.27	2	2.4	60	74649	\$2.47	10649	\$2.02	16649	\$2.83	38649	\$2.83
1.5	2	3.4	86	74650	2.68	10650	2.25	16650	3.09	38650	3.09
2.0	2	3.5	89	74652	2.93	10652	2.51	16652	3.50	38652	3.50
2.5	2	3.9	99	74654	2.97	10654	2.52	16654	3.50	38654	3.50
3.0	2	3.3	83	74656	3.08	10656	2.56	16656	3.61	38656	3.61
3.5	1	3.5	88			10658	3.48				
4.0	2	3.7	95	74660	3.63	10660	3.09	16660	4.33	38660	4.33
4.5	1	4.3	109			10662	4.25				
5.0	2	4.3	109	74664	4.74	10664	4.07	16664	5.67	38664	5.67
5.5	1	5.0	126			10666	5.92				
6	2	5.4	137	74668	5.38	10668	4.66	16668	6.49	38668	6.49
7	1	5.7	145			10670	7.28				
8	2	6.4	162	74672	7.69	10672	7.09	16672	9.89	38672	9.89
9	1	6.9	175			10674	9.50				
10	2	7.3	184	74676	8.74	10676	8.19	16676	11.43	38676	11.43

Square Ball Screwdrivers

SIZE	QTY	PART#	INCH	MM	LIST EA
#0	2	11600	3.5	90	\$4.17
#1	2	11601	3.8	95	4.78
#2	2	11602	4.0	102	5.14
#3	2	11603	4.0	102	5.71
#4	2	11604	4.5	115	6.34

BallStar™ Tip Singles

SIZE	QTY	INCH	MM	BallStar™ Tip ProGuard™ finish	
				PART#	LIST EA
T6	2	2.6	62	12706	\$6.23
T7	2	2.6	62	12707	6.23
T8	2	2.6	62	12708	6.23
T9	2	2.6	62	12709	6.23
T10	2	2.8	69	12710	6.57
T15	2	2.9	73	12715	6.57
T20	2	3.2	81	12720	6.75
T25	2	3.4	87	12725	6.93
T27	2	3.8	97	12727	7.29
T30	2	4.2	106	12730	7.79
T40	2	4.6	117	12740	8.32
T45	1	5.2	132	12745	9.87
T50	1	6.0	153	12750	11.78
T55	1	6.8	172	12755	14.15

Screwdriver Singles

Balldriver® Tip Singles with ProGuard™ finish

Inch Sizes					Balldriver® Tip Long — 2 per pkg				Balldriver® Tip Extra Long — 1 per pkg				Balldriver® Tip Custom Length — 1 per pkg	
SIZE	PART#	INCH	MM	LIST EA	PART#	INCH	MM	LIST EA	PART#	LIST EA				
.050					3702	11.1	283	\$7.46	193102	\$8.98				
1/16					3703	11.1	283	7.46	193103	8.98				
5/64	10704	4.3	110	\$2.76	3704	11.0	279	7.46	193104	8.98				
3/32	10705	4.8	122	2.84	3705	11.0	279	7.46	193105	8.98				
7/64	10706	5.9	151	3.40	3706	10.6	269	7.35	193106	8.51				
1/8	10707	6.4	164	3.40	3707	10.6	269	7.35	193107	8.56				
9/64	10708	6.9	176	3.68	3708	10.5	267	7.73	193108	9.08				
5/32	10709	7.4	189	4.40	3709	10.5	267	7.93	193109	9.30				
3/16	10710	7.9	202	4.88	3710	10.3	260	8.72	193110	10.25				
7/32	10711	8.4	214	5.46	3711	10.3	260	8.72	193111	10.30				
1/4	10712	8.9	227	6.35	3712	10.3	260	9.35	193112	11.08				
5/16	10713	9.5	241	7.58	3713	10.3	260	10.19	193113	12.03				
3/8	10714	9.9	252	8.98	3714	10.3	260	11.88	193114	13.45				
7/16					3715	10.5	267	12.88	193115	14.76				
1/2					3716	10.5	267	14.39	193116	16.34				

Metric Sizes					Balldriver® Tip Long — 2 per pkg				Balldriver® Tip Extra Long — 1 per pkg				Balldriver® Tip Custom Length — 1 per pkg	
SIZE	PART#	INCH	MM	LIST EA	PART#	INCH	MM	LIST EA	PART#	LIST EA				
1.5					3750	11.0	279	\$7.46	193150	\$8.98				
2.0	10752	4.0	102	\$2.83	3752	11.0	279	7.46	193152	8.98				
2.5	10754	4.8	122	3.03	3754	11.0	279	7.46	193154	8.98				
3	10756	6.2	158	3.58	3756	10.6	270	7.35	193156	8.56				
4	10760	7.0	179	3.86	3760	10.5	267	7.93	193160	9.30				
5	10764	7.8	198	5.28	3764	10.3	260	8.72	193164	10.25				
6	10768	8.6	218	5.65	3768	10.3	260	9.35	193168	11.08				
8	10772	9.3	237	7.83	3772	10.3	260	10.19	193172	12.03				
10	10776	10.2	259	9.64	3776	10.3	260	11.88	193176	13.45				

Star Tip Singles

ProHold® Tip					Tamper-Resistant Tip			Star Tip					
SIZE	QTY	INCH	MM	PART#	LIST EA	PART#	LIST EA	SIZE	QTY	INCH	MM	PART#	LIST EA
T5								T5	2	4.0	102	34505	\$5.00
T6	1	4.3	108			33806	\$6.50	T6	2	4.3	108	34506	3.90
T7	1	4.5	114			33807	6.50	T7	2	4.5	114	34507	3.80
T8	1	4.8	121			33808	6.50	T8	2	4.8	121	34508	3.80
T9	1	4.9	124	75509	\$6.50	33809	6.70	T9	2	4.9	124	34509	4.10
T10	1	5.0	128	75510	6.80	33810	6.70	T10	2	5.0	128	34510	4.30
T15	1	5.1	131	75515	7.00	33815	6.85	T15	2	5.1	131	34515	4.40
T20	1	5.4	138	75520	7.60	33820	8.60	T20	2	5.4	138	34520	4.80
T25	1	5.7	144	75525	8.40	33825	8.65	T25	2	5.7	144	34525	5.30
T27	1	5.8	147	75527	9.70	33827	10.25	T27	2	5.8	147	34527	6.10
T30	1	6.0	153	75530	11.50	33830	12.25	T30	2	6.0	153	34530	7.20
T40	1	6.3	159	75540	12.50	33840	13.25	T40	2	6.3	159	34540	7.85
T45	1	6.5	166	75545	13.00			T45	1	6.5	166	34545	8.20
T50	1	6.8	172	75550	14.50			T50	1	6.8	172	34550	9.10
T55	1	7.0	178	75555	16.20			T55	1	7.0	178	34555	10.15
T60	1	7.3	185	75560	17.90			T60	1	7.3	185	34560	11.20



Fold Up Tools

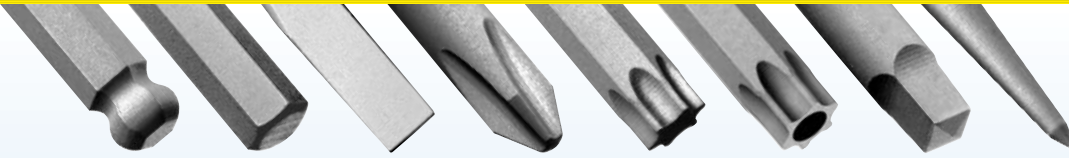

GorillaGrip® Fold Ups



Handle is 40% stronger than steel handles

Comfortable to hold, and does not conduct heat or cold

Protected by 7 US and foreign patents

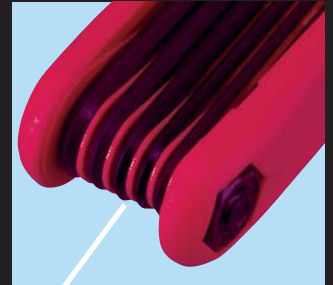

Patented Flutes:
Flutes allow for easy selection of one tool at a time



Quick Blade Selection:
Blades are accessed from both the top and bottom, eliminating the constant 'unstacking' of blades

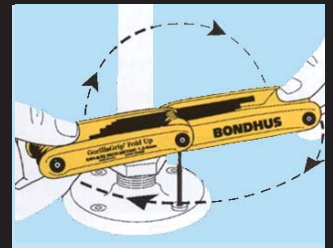

Turn & Flip Feature:
Eliminates constant removal and repositioning in screw head when working against obstructions

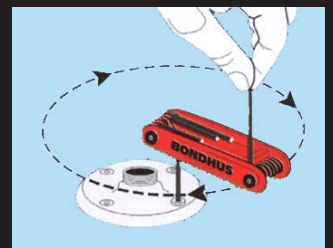

Speed Wrench Feature:
90° stop converts the tool into a non-stop, time saving, speed wrench

Color Coded

- Inch
- Metric
- Inch & Metric
- Star
- Utility

ProTanium High Torque Steel:

- Up to 20% stronger, with more torque and twice the wear resistance of standard grades of steel.

ProGuard Corrosion-resistant finish:

- Environmentally safe, provides better tool grip, resists solvents and is 5 times more corrosion resistant than competitor finishes.

Fold Up Sets

GorillaGrip® Fold Ups

Inch Sizes



Balldriver® Tip

SIZE	PCS	PART#	MODEL#	LIST EA
.050 – 3/16	9			
5/64 – 1/4	9			
3/16 – 3/8	5	12894	BF5	\$13.05



Hex Tip

PART#	MODEL#	LIST EA
12591	HF9S	\$5.15
12589	HF9	6.60
12585	HF5	9.35

Metric Sizes

SIZE	PCS	PART#	MODEL#	LIST EA
1.5 – 6mm	7			
2 – 8mm	7			
3 – 10mm	6			
5 – 10mm	5	12897	BF5M	\$13.05

Inch/Metric Sizes

(5/64 – 5/32) (1.5 – 5mm)	12				12550	HF12	\$9.15
------------------------------	----	--	--	--	-------	------	--------



Metal Fold Ups

Inch Sizes



Hex Tip

SIZE	PCS	PART#	MODEL#	LIST EA
.050 – 3/16	9	14591	MHF9S	\$4.66
5/64 – 1/4	9	14589	MHF9	5.94
3/16 – 3/8	5	14585	MHF5	8.36

Metric Sizes

SIZE	PCS	PART#	MODEL#	LIST EA
1.5 – 6mm	7	14592	MHF7MS	\$4.83
2 – 8mm	7	14587	MHF7M	6.38
3 – 10mm	6	14595	MHF6M	8.90



GorillaGrip® Fold Ups



Star Tip

SIZE	PCS	PART#	MODEL#	LIST EA
T6 – T25	8	12632	TF8S	\$12.85
T7 – T25	7			
T9 – T40	8	12634	TF8	13.10



Tamper-Resistant Tip

PART#	MODEL#	LIST EA
12636	TR-TF7S	\$13.05
12638	TR-TF8	15.40



Metal Fold Ups



Star Tip

SIZE	PCS	PART#	MODEL#	LIST EA
T6 – T25	8	14532	MTF8S	\$11.55
T9 – T40	8	14534	MTF8	11.55



GorillaGrip® Utility Fold Ups

SIZE	PCS	PART#	MODEL #	LIST EA	PART#	MODEL #	LIST EA	PART#	MODEL #	LIST EA	PART#	MODEL #	LIST EA
(#1, #2 Ph) (1/8, 3/16, 1/4 Slotted)	5	12547	FU5	\$6.80									
(#1 Ph) (3/16 Slotted)	5				12540	HFU5	\$6.80						
(4, 5, 6mm Hex) (#1, #2 Ph) (3/16 Slotted)	5							12543	RFU5	\$6.80			
(#1, #2 Square) (#1, #2 Ph) (Awl) (1/8, 3/16 Slotted)	5										12545	AFU5	\$6.80



GorillaGrip® Multipacks

TIP	INCH SIZE	METRIC SIZE	STAR SIZE	PCS	PART#	MODEL #	LIST EA
Hex	5/64 – 1/4	2 – 8mm		16	12522	HF16	\$12.98
Hex & Star	5/64 – 1/4	2 – 8mm	T9 – T40	24	12533	HF24	25.25
Hex & Star		2 – 8mm	T9 – T40	15	12544	HF15	19.05



Ball End Bits and Blades

Ball End Bits & Blades with ProGuard™ finish

Insert Bit Sets

1" / 25mm Balldriver® Insert Bits are designed for power tools having 1/4" retaining ring or magnetic hex adapters. They are ideal when assembly time is critical.



Inch Sizes



Balldriver® Tip



SIZE	PCS	PART#	MODEL#	LIST EA
5/64 – 1/2	12	11036	BIX12	\$27.26

Metric Sizes

SIZE	PCS	PART#	MODEL#	LIST EA
2 – 12mm	9	11099	BIX9M	\$23.98

Power Bit Sets

3" / 76mm Balldriver® Power Bits are designed for power tools with 1/4" ball detent hex adapters. Saves time and increases productivity.



Inch Sizes



Balldriver® Tip



SIZE	PCS	PART#	MODEL#	LIST EA
5/64 – 1/2	12	10836	BHX12	\$32.46

Metric Sizes

SIZE	PCS	PART#	MODEL#	LIST EA
2 – 12mm	9	10899	BHX9M	\$27.90

Balldriver® Insert Bit Singles

Inch Sizes



SIZE	QTY	PART#	INCH	MM	LIST EA
5/64	10	11004	1.0	25	\$1.29
3/32	10	11005	1.0	25	1.29
7/64	10	11006	1.0	25	1.29
1/8	10	11007	1.0	25	1.29
9/64	10	11008	1.0	25	1.29
5/32	10	11009	1.0	25	1.29
3/16	10	11010	1.0	25	1.29
7/32	10	11011	1.0	25	1.29
1/4	10	11012	1.0	25	1.29
5/16	1	11013	1.5	38	4.80
3/8	1	11014	1.5	38	5.00
1/2	1	11016	1.5	38	5.66

Metric Sizes

SIZE	QTY	PART#	INCH	MM	LIST EA
2	10	11052	1.0	25	\$1.29
2.5	10	11054	1.0	25	1.29
3	10	11056	1.0	25	1.29
4	10	11060	1.0	25	1.29
5	10	11064	1.0	25	1.29
6	10	11068	1.0	25	1.29
8	1	11072	1.5	38	4.80
10	1	11076	1.5	38	5.19
12	1	11080	1.5	38	5.57

Balldriver® Power Bit Singles

Inch Sizes



SIZE	QTY	PART#	INCH	MM	LIST EA
5/64	10	10804	3.0	76	\$1.83
3/32	10	10805	3.0	76	1.83
7/64	10	10806	3.0	76	1.83
1/8	10	10807	3.0	76	1.83
9/64	10	10808	3.0	76	1.83
5/32	10	10809	3.0	76	1.83
3/16	10	10810	3.0	76	1.83
7/32	10	10811	3.0	76	1.83
1/4	10	10812	3.0	76	1.83
5/16	1	10813	3.0	76	5.10
3/8	1	10814	3.0	76	5.46
1/2	1	10816	3.0	76	6.43

Metric Sizes

SIZE	QTY	PART#	INCH	MM	LIST EA
2	10	10852	3.0	76	\$1.83
2.5	10	10854	3.0	76	1.83
3	10	10856	3.0	76	1.83
4	10	10860	3.0	76	1.83
5	10	10864	3.0	76	1.83
6	10	10868	3.0	76	1.83
8	1	10872	3.0	76	5.10
10	1	10876	3.0	76	5.57
12	1	10880	3.0	76	6.24

Ball End Blades

Balldriver® Blade Singles with ProGuard™ finish

Ideal for use in socket wrenches, power tools or with a Hextender for added reach.

Quantity 1 per package.



Inch Sizes	Standard Length				Long Length				Extra Long Length				
	SIZE	PART#	INCH	MM	LIST EA	PART#	INCH	MM	LIST EA	PART#	INCH	MM	LIST EA
.050	0102	3.4	86	\$0.87						3602	12.0	305	\$5.92
1/16	0103	3.5	91	0.87						3603	12.0	305	5.92
5/64	0104	3.6	93	0.87	0404	5.3	135	\$1.53		3604	12.0	305	5.92
3/32	0105	3.8	96	0.90	0405	5.8	147	1.53		3605	12.0	305	5.97
7/64	0106	4.3	109	1.03	0406	7.3	186	1.53		3606	12.0	305	6.03
1/8	0107	4.5	115	1.06	0407	7.8	199	1.80		3607	12.0	305	6.08
9/64	0108	4.8	121	1.06	0408	8.4	214	1.80		3608	12.0	305	6.18
5/32	0109	5.1	129	1.11	0409	8.9	227	2.61		3609	12.0	305	6.39
3/16	0110	5.5	139	1.28	0410	9.7	246	2.67		3610	12.0	305	6.70
7/32	0111	5.9	151	1.54	0411	10.2	259	3.12		3611	12.0	305	6.70
1/4	0112	6.7	170	1.77	0412	10.7	272	3.84		3612	12.0	305	6.70
5/16	0113	7.3	186	2.81	0413	11.3	286	5.63		3613	12.0	305	7.62
3/8	0114	8.2	208	3.95	0414	11.7	297	6.27		3614	12.0	305	9.12
7/16	0115	9.1	232	8.17						3615	12.0	305	10.76
1/2	0116	10.1	255	10.46						3616	12.0	305	12.31
9/16	0117	10.9	277	12.79									
5/8	0118	11.8	299	14.29									
3/4	0119	13.5	344	23.65									

Metric Sizes	Standard Length				Long Length				Extra Long Length				
	SIZE	PART#	INCH	MM	LIST EA	PART#	INCH	MM	LIST EA	PART#	INCH	MM	LIST EA
1.5	0150	3.6	91	\$0.87						3650	12.0	305	\$5.92
2.0	0152	3.8	98	0.87	0452	5.0	128	\$1.53		3652	12.0	305	5.92
2.5	0154	4.2	107	0.92	0454	5.8	148	1.53		3654	12.0	305	5.97
3.0	0156	4.6	118	1.04	0456	7.6	193	1.80		3656	12.0	305	6.08
3.5	0158	4.8	123	1.08									
4.0	0160	5.2	133	1.11	0460	8.5	217	2.05		3660	12.0	305	6.39
4.5	0162	5.5	140	1.27									
5.0	0164	5.8	148	1.41	0464	9.6	243	2.76		3664	12.0	305	6.70
5.5	0166	6.1	155	1.64									
6	0168	6.7	170	1.88	0468	10.4	263	3.53		3668	12.0	305	6.70
7	0170	7.3	184	2.54									
8	0172	7.8	199	3.00	0472	11.1	281	4.73		3672	12.0	305	7.62
9	0174	8.4	214	3.60									
10	0176	9.0	229	4.39	0476	11.9	303	7.17		3676	12.0	305	9.22
11	0178	9.6	245	8.09									
12	0180	10.5	267	9.70									
14	0184	12.5	318	12.13									
17	0186	13.6	346	19.24									
19	0188	14.5	368	22.82									

Hextender

Quantity 1 per package.

Inch Sizes

SIZE	INCH	MM	DIA	PART#	LIST EA
.050	.5	13	0.25	22302	\$12.35
1/16	.5	13	0.25	22303	12.35
5/64	.5	13	0.25	22304	12.35
3/32	.5	13	0.25	22305	12.35
7/64	.5	13	0.25	22306	12.35
1/8	.5	13	0.31	22307	12.35
9/64	.5	13	0.31	22308	12.35
5/32	.75	19	0.37	22309	12.35
3/16	.75	19	0.37	22310	12.35
7/32	.75	19	0.50	22311	12.35
1/4	.75	19	0.50	22312	12.35
5/16	1.0	25	0.75	22313	12.35
3/8	1.0	25	0.75	22314	12.35

Metric Sizes

SIZE	INCH	MM	DIA	PART#	LIST EA
1.5	.5	13	0.25	22350	\$12.35
2.0	.5	13	0.25	22352	12.35
2.5	.5	13	0.25	22354	12.35
3	.5	13	0.31	22356	12.35
4	.75	19	0.37	22360	12.35
5	.75	19	0.37	22364	12.35
6	.75	19	0.50	22368	12.35
8	1.0	25	0.75	22372	12.35
10	1.0	25	0.75	22376	12.35



T-Handle Tools

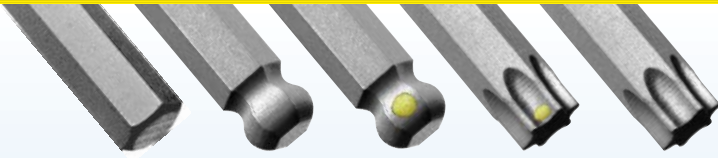

Handle and blade are securely welded and will never loosen or slip.



Color Coded

- Inch
- Metric
- Star

Proanium High Torque Steel:

- Up to 20% stronger, with more torque and twice the wear resistance of standard grades of steel.

ProGuard DST Corrosion-resistant finish:

- Environmentally safe, provides better tool grip, resists solvents and is 5 times more corrosion resistant than competitor finishes.

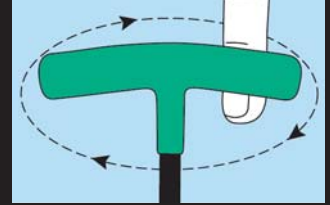

Heavy duty handle generates a flywheel effect for super fast insertion or removal of screws.

Handle is shaped for comfort and control, and is ergonomically superior to older style straight handles.

Available in 6, 9", and graduated blade lengths

Cushioned feel reduces fatigue



Handle sizes are engineered to match blade torque capabilities:

The 5/32, 3/16", 4 and 5mm blades, in ball end sets, have smaller handles to prevent over-torquing.



The 3/32, 7/64, 1/8, 9/64" and 2, 2.5 and 3mm blades are always straight hex tips to prevent breakage. A T-Handle could easily over-torque and break smaller size ball end tips.

T-Handle Sets

Hex, Ball End & Star Sets with ProGuard™ finish



Inch Sizes

				ProHold® Tip			Balldriver® Tip			Hex Tip		
SIZE	PCS	LENGTH	W/STAND	PART#	MODEL#	LIST EA	PART#	MODEL#	LIST EA	PART#	MODEL#	LIST EA
3/32 – 1/4	8	Graduated								13332	HTX80	\$28.10
"	"	8	6 inch							15232	HTX80-6	26.30
"	"	8	9 inch							15332	HTX80-9	38.14
3/32 – 3/8	10	Graduated	✓				*113190	BTX10/S	\$52.70	†13390	HTX10/S	44.80
"	"	10	"				*13138	BTX10	49.45	†13338	HTX10	41.55
"	"	10	6 inch	✓						†15290	HTX10/S-6	42.65
"	"	10	"							15238	HTX10-6	39.50
"	"	10	9 inch	✓						†15390	HTX10/S-9	59.13
"	"	10	"							15338	HTX10-9	55.98
5/32 - 3/8	6	Graduated		75146	PBTX60	\$40.85	13146	BTX60	36.65			

Metric Sizes

				ProHold® Tip			Balldriver® Tip			Hex Tip		
SIZE	PCS	LENGTH	W/STAND	PART#	MODEL#	LIST EA	PART#	MODEL#	LIST EA	PART#	MODEL#	LIST EA
2 – 6mm	6	Graduated								13348	HTX60M	\$26.55
"	"	6	6 inch							15248	HTX60M-6	19.70
"	"	6	9 inch							15348	HTX60M-9	29.96
2 – 10mm	8	Graduated	✓				*113189	BTX80M/S	\$43.80	†13389	HTX80M/S	41.10
"	"	8	"				*13187	BTX80M	40.55	†13387	HTX80M	37.85
"	"	8	6 inch	✓						†15289	HTX80M/S-6	38.15
"	"	8	"							15287	HTX80M-6	35.00
"	"	8	9 inch	✓						†15389	HTX80M/S-9	51.17
"	"	8	"							15387	HTX80M-9	48.02
4 – 10mm	5	Graduated		75148	PBTX50M	\$34.95	13148	BTX50M	31.50			

* The 3/32, 7/64, 1/8, and 9/64 inch blades, and the 2, 2.5 and 3mm blades are straight hex blades to prevent breakage.

† With stand

Star Sets with Stand

				ProHold® Tip		
SIZE	PCS	LENGTH	W/STAND	PART#	MODEL#	LIST EA
T9 – T40	8	Graduated	✓	74034	PHTTHX8	\$68.85

				Star Tip		
SIZE	PCS	LENGTH	W/STAND	PART#	MODEL#	LIST EA
T9 – T40	8	Graduated	✓	33034	TTHX8	\$45.00

Star Singles — Graduated Lengths

		ProHold® Tip		Star Tip			
SIZE	QTY	INCH	MM	PART#	LIST EA	PART#	LIST EA
T9	2	6.1	155	74009	\$6.85	33009	\$4.30
T10	2	6.4	161	74010	7.20	33010	4.50
T15	2	6.6	168	74015	7.65	33015	4.80
T20	2	6.9	174	74020	8.00	33020	5.00
T25	2	7.1	180	74025	8.30	33025	5.20
T27	2	7.4	187	74027	8.80	33027	5.50
T30	2	7.6	193	74030	9.25	33030	5.80
T40	2	7.9	199	74040	10.40	33040	6.50
T45	2	8.1	206	74045	11.60	33045	7.25
T50	2	8.4	213	74050	13.60	33050	8.50
T55	2	8.6	218	74055	15.00	33055	11.00



T-Handle Singles

T-Handle Singles with ProGuard™ finish



Inch Sizes

Inch Sizes		Graduated Length ProHold® Tip				Graduated Length Balldriver® Tip				Graduated Length Hex Tip			
SIZE	QTY	PART#	INCH	MM	LIST EA	PART#	INCH	MM	LIST EA	PART#	INCH	MM	LIST EA
3/32	2					13205*	6.1	154	\$3.37	13305	4.2	105	\$3.37
7/64	2					13206*	6.8	173	3.60	13306	4.4	112	3.60
1/8	2					13207*	7.6	192	3.82	13307	4.6	118	3.72
9/64	2					13208*	8.3	211	4.05	13308	4.9	124	3.82
5/32	2	75109	9.1	231	\$4.95	13109	9.1	231	4.40	13309	5.2	132	3.94
3/16	2	75110	9.8	250	5.29	13110	9.8	250	4.64	13310	5.6	141	4.05
7/32	2	75111	10.3	262	6.25	13111	10.3	262	5.46	13311	6.1	154	4.27
1/4	2	75112	10.8	275	6.39	13112	10.8	275	5.60	13312	6.5	165	4.50
5/16	2	75113	11.4	289	9.27	13113	11.4	289	8.57	13313	7.4	189	7.32
3/8	2	75114	11.8	300	10.12	13114	11.8	300	9.46	13314	8.3	211	8.44

Metric Sizes

SIZE	QTY	PART#	INCH	MM	LIST EA	PART#	INCH	MM	LIST EA	PART#	INCH	MM	LIST EA
2.0	2					13252*	5.9	150	\$3.82	13352	4.0	100	\$3.82
2.5	2					13254*	6.8	172	3.82	13354	4.3	110	3.82
3	2					13256*	7.7	196	4.05	13356	4.7	120	4.05
4	2	75160	8.7	220	\$5.18	13160	8.7	220	4.63	13360	5.3	136	4.39
5	2	75164	9.7	246	6.04	13164	9.7	246	5.33	13364	5.9	150	4.95
6	2	75168	10.5	266	6.57	13168	10.5	266	5.79	13368	6.8	173	5.52
8	2	75172	11.2	285	9.40	13172	11.2	285	8.71	13372	7.9	202	7.77
10	2	75176	12.1	307	10.21	13176	12.1	307	9.54	13376	9.1	232	8.89

* The 3/32, 7/64, 1/8, and 9/64 inch blades, and the 2, 2.5 and 3mm blades are straight hex blades to prevent breakage.

Inch Sizes

Inch Sizes		6" – Hex Tip				9" – Hex Tip			
SIZE	QTY	PART#	INCH	MM	LIST EA	PART#	INCH	MM	LIST EA
3/32	2	15205	6.0	152	\$2.60	15305	9.0	229	\$3.94
7/64	2	15206	6.0	152	2.65	15306	9.0	229	4.19
1/8	2	15207	6.0	152	2.95	15307	9.0	229	4.45
9/64	2	15208	6.0	152	3.15	15308	9.0	229	4.57
5/32	2	15209	6.0	152	3.30	15309	9.0	229	4.72
3/16	2	15210	6.0	152	3.65	15310	9.0	229	4.81
7/32	2	15211	6.0	152	3.75	15311	9.0	229	5.67
1/4	2	15212	6.0	152	4.25	15312	9.0	229	5.81
5/16	2	15213	6.0	152	6.90	15313	9.0	229	8.48
3/8	2	15214	6.0	152	7.70	15314	9.0	229	9.36

Metric Sizes

SIZE	QTY	PART#	INCH	MM	LIST EA	PART#	INCH	MM	LIST EA
2.0	2	15252	6.0	152	\$2.65	15352	9.0	229	\$4.45
2.5	2	15254	6.0	152	2.65	15354	9.0	229	4.45
3	2	15256	6.0	152	2.90	15356	9.0	229	4.72
4	2	15260	6.0	152	3.30	15360	9.0	229	4.81
5	2	15264	6.0	152	3.60	15364	9.0	229	5.52
6	2	15268	6.0	152	4.60	15368	9.0	229	6.01
8	2	15272	6.0	152	7.25	15372	9.0	229	8.62
10	2	15276	6.0	152	8.05	15376	9.0	229	9.44





PT#	PG#	LIST EA	PT#	PG#	LIST EA	PT#	PG#	LIST EA	PT#	PG#	LIST EA	PT#	PG#	LIST EA	PT#	PG#	LIST EA
12902	26	\$0.63	13354	44	\$3.82	13949	26	\$0.14	15364	44	\$5.52	15866	27	\$0.66	16200	29	\$0.52
12903	26	0.63	13356	44	4.05	13950	26	0.16	15368	44	6.01	15868	27	0.66	16201	29	0.52
12904	26	0.65	13360	44	4.39	13952	26	0.16	15372	44	8.62	15870	27	1.03	16202	29	0.36
12905	26	0.70	13364	44	4.95	13954	26	0.23	15376	44	9.44	15872	27	1.03	16203	29	0.36
12906	26	0.80	13368	44	5.52	13956	26	0.23	15387	43	48.02	15874	27	1.72	16204	29	0.41
12907	26	0.83	13372	44	7.77	13958	26	0.28	15389	43	51.17	15876	27	1.72	16205	29	0.41
12908	26	0.83	13376	44	8.89	13960	26	0.28	15390	43	59.13	15878	27	4.36	16206	29	0.43
12909	26	0.87	13387	43	37.85	13962	26	0.43	15702	26	0.92	15880	27	4.36	16207	29	0.43
12910	26	0.99	13389	43	41.10	13964	26	0.43	15703	26	0.92	15884	27	5.97	16208	29	0.46
12911	26	1.32	13390	43	44.80	13966	26	0.70	15704	26	0.92	15886	27	6.49	16209	29	0.46
12912	26	1.55	13532	15, 21, 35	56.46	13968	26	0.70	15705	26	0.96	15888	27	11.02	16210	29	0.57
12913	26	2.42	13546	15, 21, 35	38.05	13970	26	1.24	15706	26	1.09	15900	26	0.55	16211	29	0.88
12914	26	3.54	13800	27	0.19	13972	26	1.24	15707	26	1.13	15901	26	0.55	16212	29	0.88
12915	26	7.49	13801	27	0.19	13974	26	1.95	15708	26	1.13	15902	26	0.31	16213	29	1.39
12916	26	9.58	13802	27	0.11	13976	26	1.95	15709	26	1.17	15903	26	0.34	16214	29	2.32
12917	26	11.97	13803	27	0.11	13978	26	4.35	15710	26	1.36	15904	26	0.34	16215	29	4.74
12918	26	13.38	13804	27	0.13	13980	26	4.35	15711	26	1.64	15905	26	0.34	16216	29	4.74
12919	26	22.38	13805	27	0.13	13984	26	5.90	15712	26	1.89	15906	26	0.41	16217	29	5.97
12949	26	0.63	13806	27	0.14	13986	26	8.44	15713	26	3.00	15907	26	0.43	16218	29	7.73
12950	26	0.63	13807	27	0.14	13988	26	11.85	15714	26	4.19	15908	26	0.43	16219	29	11.95
12952	26	0.65	13808	27	0.16	14126	20	24.60	15715	26	8.67	15909	26	0.49	16236	25	7.20
12954	26	0.70	13809	27	0.16	14128	20	24.80	15716	26	11.10	15910	26	0.55	16237	25	9.55
12956	26	0.83	13810	27	0.23	14130	20	36.85	15717	26	13.57	15911	26	0.79	16238	25	5.90
12958	26	0.87	13811	27	0.33	14132	20	40.35	15718	26	15.17	15912	26	1.05	16246	25	4.95
12960	26	0.87	13812	27	0.41	14138	20	40.60	15719	26	25.09	15913	26	1.62	16247	29	0.52
12962	26	1.09	13813	27	0.67	14187	20	19.30	15749	26	0.92	15914	26	2.34	16248	29	0.52
12964	26	1.09	13814	27	1.02	14189	20	21.60	15750	26	0.92	15915	26	4.93	16249	29	0.36
12966	26	1.37	13815	27	2.38	14532	39	11.55	15752	26	0.92	15916	26	5.57	16250	29	0.36
12968	26	1.66	13816	27	2.80	14534	39	11.55	15754	26	0.98	15917	26	7.28	16252	29	0.39
12970	26	2.28	13817	27	3.94	14585	39	8.36	15756	26	1.11	15918	26	11.45	16254	29	0.39
12972	26	2.60	13818	27	5.18	14587	39	6.38	15758	26	1.15	15919	26	16.66	16256	29	0.43
12974	26	3.19	13819	27	8.34	14589	39	5.94	15760	26	1.17	15947	26	0.55	16258	29	0.46
12976	26	3.96	13847	27	0.19	14591	39	4.66	15762	26	1.35	15948	26	0.55	16260	29	0.46
12978	26	7.40	13848	27	0.19	14592	39	4.83	15764	26	1.49	15949	26	0.31	16262	29	0.57
12980	26	8.88	13849	27	0.11	14595	39	8.90	15766	26	1.74	15950	26	0.34	16264	29	0.57
12984	26	11.36	13850	27	0.11	15205	44	2.60	15768	26	1.99	15952	26	0.34	16266	29	0.88
12986	26	18.00	13852	27	0.13	15206	44	2.65	15770	26	2.70	15954	26	0.41	16268	29	0.88
12988	26	21.59	13854	27	0.14	15207	44	2.95	15772	26	3.19	15956	26	0.41	16270	29	1.39
13109	44	4.40	13856	27	0.14	15208	44	3.15	15774	26	3.83	15958	26	0.49	16272	29	1.39
13110	44	4.64	13858	27	0.16	15209	44	3.30	15776	26	4.66	15960	26	0.49	16274	29	2.32
13111	44	5.46	13860	27	0.16	15210	44	3.65	15778	26	8.58	15962	26	0.74	16276	29	2.32
13112	44	5.60	13862	27	0.28	15211	44	3.75	15780	26	10.30	15964	26	0.74	16278	29	4.74
13113	44	8.57	13864	27	0.28	15212	44	4.25	15784	26	12.88	15966	26	1.05	16280	29	4.74
13114	44	9.46	13866	27	0.41	15213	44	6.90	15786	26	20.41	15968	26	1.05	16284	29	6.18
13138	21	49.45	13868	27	0.41	15214	44	7.70	15788	26	24.21	15970	26	1.72	16286	29	7.21
13146	21	36.65	13870	27	0.70	15232	43	26.30	15800	27	0.37	15972	26	1.72	16288	29	11.95
13148	21	31.50	13872	27	0.70	15238	43	39.50	15801	27	0.37	15974	26	2.70	16292	25	6.05
13160	44	4.63	13874	27	1.24	15248	43	19.70	15802	27	0.27	15976	26	2.70	16299	25	8.90
13164	44	5.33	13876	27	1.24	15252	44	2.65	15803	27	0.27	15978	26	5.81	16502	23, 27	1.10
13168	44	5.79	13878	27	3.15	15254	44	2.65	15804	27	0.30	15980	26	5.81	16503	23, 27	1.10
13172	44	8.71	13880	27	3.15	15256	44	2.90	15805	27	0.30	15984	26	7.72	16504	23, 27	1.10
13176	44	9.54	13884	27	4.33	15260	44	3.30	15806	27	0.31	15986	26	11.03	16505	23, 27	1.15
13187	21	40.55	13886	27	4.80	15264	44	3.60	15807	27	0.31	15988	26	15.32	16506	23, 27	1.30
13189	21	43.80	13888	27	8.16	15268	44	4.60	15808	27	0.34	16100	28	0.72	16507	23, 27	1.35
13190	21	52.70	13900	26	0.28	15272	44	7.25	15809	27	0.34	16101	28	0.72	16508	23, 27	1.35
13205	44	3.37	13901	26	0.28	15276	44	8.05	15810	27	0.41	16102	28	0.43	16509	23, 27	1.40
13206	44	3.60	13902	26	0.14	15287	43	35.00	15811	27	0.57	16103	28	0.46	16510	23, 27	1.60
13207	44	3.82	13903	26	0.16	15289	43	38.15	15812	27	0.66	16104	28	0.46	16511	23, 27	1.95
13208	44	4.05	13904	26	0.16	15290	43	42.65	15813	27	1.01	16105	28	0.57	16512	23, 27	2.25
13252	44	3.82	13905	26	0.16	15305	44	3.94	15814	27	1.47	16106	28	0.57	16513	23, 27	3.50
13254	44	3.82	13906	26	0.23	15306	44	4.19	15815	27	3.45	16107	28	0.57	16514	23, 27	4.90
13256	44	4.05	13907	26	0.24	15307	44	4.45	15816	27	4.07	16108	28	0.67	16537	19, 23	20.25
13305	44	3.37	13908	26	0.24	15308	44	4.57	15817	27	5.58	16109	28	0.67	16538	19, 23, 25	12.65
13306	44	3.60	13909	26	0.28	15309	44	4.72	15818	27	7.26	16110	28	0.98	16549	23, 27	1.10
13307	44	3.72	13910	26	0.32	15310	44	4.81	15819	27	11.55	16111	28	1.39	16550	23, 27	1.10
13308	44	3.82	13911	26	0.50	15311	44	5.67	15847	27	0.37	16112	28	1.39	16552	23, 27	1.10
13309	44	3.94	13912	26	0.70	15312	44	5.81	15848	27	0.37	16113	28	2.32	16554	23, 27	1.15
13310	44	4.05	13913	26	1.13	15313	44	8.48	15849	27	0.27	16114	28	3.61	16556	23, 27	1.35
13311	44	4.27	13914	26	1.67	15314	44	9.36	15850	27	0.27	16115	28	7.42	16560	23, 27	1.40
13312	44	4.50	13915	26	3.65	15332	43	38.14	15852	27	0.30	16116	28	7.42	16564	23, 27	1.80
13313	44	7.32	13916	26	4.12	15338	43	55.98	15854	27	0.30	16117	28	8.24	16568	23, 27	2.35
13314	44	8.44	13917	26	5.51	15348	43	29.96	15856	27	0.31	16118	28	11.85	16572	23, 27	3.80
13332	44	28.10	13918	26	8.66	15352	44	4.45	15858	27	0.34	16119	28	15.97	16576	23, 27	5.60
13338	43	41.55	13919	26	12.73	15354	44	4.45	15860	27	0.34	16136	25	10.15	16592	19, 23, 25	10.00
13348	43	26.55	13947	26	0.28	15356	44	4.72	15862	27	0						

PT#	PG#	LIST EA	PT#	PG#	LIST EA	PT#	PG#	LIST EA	PT#	PG#	LIST EA	PT#	PG#	LIST EA	PT#	PG#	LIST EA
16603	36	\$3.09	17046	19, 25	\$7.80	22312	41	\$12.35	26552	23, 27	\$0.99	27174	28	\$3.24	28268	30	\$0.74
16604	36	3.50	17049	28	1.08	22313	41	12.35	26554	23, 27	1.04	27176	28	3.24	28270	30	1.18
16605	36	3.50	17050	28	1.08	22314	41	12.35	26556	23, 27	1.22	27178	28	7.26	28272	30	1.18
16606	36	3.61	17052	28	1.08	22350	41	12.35	26560	23, 27	1.26	27180	28	7.26	28274	30	2.06
16607	36	3.61	17054	28	1.13	22352	41	12.35	26564	23, 27	1.62	27902	31	0.86	28276	30	2.06
16608	36	4.33	17056	28	1.29	22354	41	12.35	26568	23, 27	2.12	27903	31	0.86	28278	30	4.43
16609	36	4.33	17058	28	1.39	22356	41	12.35	26572	23, 27	3.42	27904	31	0.86	28280	30	4.43
16610	36	5.67	17060	28	1.39	22360	41	12.35	26576	23, 27	5.04	27905	31	1.00	29147	30	0.41
16611	36	6.49	17062	28	1.60	22364	41	12.35	26702	23, 29	1.26	27906	31	1.10	29148	30	0.41
16612	36	6.49	17064	28	1.75	22368	41	12.35	26703	23, 29	1.26	27907	31	1.21	29149	30	0.28
16613	36	9.89	17066	28	2.06	22372	41	12.35	26704	23, 29	1.26	27908	31	1.21	29150	30	0.31
16614	36	11.43	17068	28	2.32	22376	41	12.35	26705	23, 29	1.30	27909	31	1.26	29152	30	0.31
16615	36	20.70	17070	28	3.14	26100	28	0.41	26706	23, 29	1.48	27910	31	1.42	29154	30	0.40
16616	36	24.20	17072	28	3.76	26101	28	0.41	26707	23, 29	1.53	27911	31	1.84	29156	30	0.40
16632	35	26.80	17074	28	4.48	26102	28	0.28	26708	23, 29	1.53	27912	31	2.15	29158	30	0.46
16637	35	64.85	17076	28	5.46	26103	28	0.31	26709	23, 29	1.58	27913	31	3.41	29160	30	0.46
16649	36	2.83	17078	28	9.06	26104	28	0.31	26710	23, 29	1.81	27914	31	4.78	29162	30	0.72
16650	36	3.09	17080	28	9.06	26105	28	0.40	26711	23, 29	2.18	28049	31	0.86	29164	30	0.72
16652	36	3.50	17084	28	12.88	26106	28	0.40	26712	23, 29	2.55	28050	31	0.86	29166	30	1.18
16654	36	3.50	17086	28	19.57	26107	28	0.40	26713	23, 29	3.94	28052	31	0.86	29168	30	1.18
16656	36	3.61	17088	28	24.72	26108	28	0.46	26714	23, 29	5.56	28054	31	1.00	29170	30	2.06
16660	36	4.33	17092	19, 25	10.45	26109	28	0.46	26749	23, 29	1.26	28056	31	1.10	29172	30	2.06
16664	36	5.67	17095	19, 25	28.70	26110	28	0.72	26750	23, 29	1.26	28058	31	1.26	29174	30	3.24
16668	36	6.49	17099	19, 25	17.10	26111	28	1.18	26752	23, 29	1.26	28060	31	1.26	29176	30	3.24
16672	36	9.89	17146	25	6.15	26112	28	1.18	26754	23, 29	1.30	28062	31	1.42	29178	30	7.26
16676	36	11.43	17147	28	0.72	26113	28	2.06	26756	23, 29	1.48	28064	31	1.58	29180	30	7.26
16686	35	24.75	17148	28	0.72	26114	28	3.24	26760	23, 29	1.58	28066	31	2.00	31705	17, 33	2.50
16699	35	53.55	17149	28	0.43	26200	29	0.31	26764	23, 29	2.00	28068	31	2.21	31706	17, 33	2.50
16702	23, 29	1.39	17150	28	0.46	26201	29	0.31	26768	23, 29	2.65	28070	31	3.05	31707	17, 33	2.25
16703	23, 29	1.39	17152	28	0.46	26202	29	0.21	26772	23, 29	4.32	28072	31	3.62	31708	17, 33	2.25
16704	23, 29	1.39	17154	28	0.57	26203	29	0.21	26776	23, 29	6.26	28074	31	4.46	31709	17, 33	2.25
16705	23, 29	1.44	17156	28	0.57	26204	29	0.24	26902	28	0.84	28076	31	5.46	31710	17, 33	1.25
16706	23, 29	1.65	17158	28	0.67	26205	29	0.24	26903	28	0.84	28078	31	9.03	31715	17, 33	1.30
16707	23, 29	1.70	17160	28	0.67	26206	29	0.29	26904	28	0.84	28080	31	9.03	31720	17, 33	1.40
16708	23, 29	1.70	17162	28	0.98	26207	29	0.29	26905	28	0.98	28100	30	0.41	31725	17, 33	1.45
16709	23, 29	1.75	17164	28	0.98	26208	29	0.31	26906	28	1.08	28101	30	0.41	31727	17, 33	1.50
16710	23, 29	2.01	17166	28	1.39	26209	29	0.31	26907	28	1.18	28102	30	0.28	31730	17, 33	1.60
16711	23, 29	2.42	17168	28	1.39	26210	29	0.46	26908	28	1.18	28103	30	0.31	31732	15, 33	14.20
16712	23, 29	2.83	17170	28	2.32	26211	29	0.74	26909	28	1.24	28104	30	0.31	31734	15, 33	12.30
16713	23, 29	4.38	17172	28	2.32	26212	29	0.74	26910	28	1.39	28105	30	0.40	31740	17, 33	1.80
16714	23, 29	6.18	17174	28	3.61	26213	29	1.18	26911	28	1.80	28106	30	0.40	31745	17, 33	2.20
16737	19, 23, 25	26.80	17176	28	3.61	26214	29	2.06	26912	28	2.11	28107	30	0.40	31750	17, 33	2.50
16738	19, 23, 25	16.75	17178	28	7.42	26247	29	0.31	26913	28	3.35	28108	30	0.46	31755	17, 33	4.25
16749	23, 29	1.39	17180	28	7.42	26248	29	0.31	26914	28	4.69	28109	30	0.46	31760	17, 33	6.00
16750	23, 29	1.39	17184	28	8.24	26249	29	0.21	27049	28	0.84	28110	30	0.72	31806	17, 33	2.90
16752	23, 29	1.39	17186	28	11.33	26250	29	0.21	27050	28	0.84	28111	30	1.18	31807	17, 33	2.60
16754	23, 29	1.44	17188	28	14.94	26252	29	0.24	27052	28	0.84	28112	30	1.18	31808	17, 33	2.60
16756	23, 29	1.65	17192	25	7.95	26254	29	0.24	27054	28	0.98	28113	30	2.06	31809	17, 33	2.60
16760	23, 29	1.75	17195	25	22.60	26256	29	0.29	27056	28	1.08	28114	30	3.24	31810	17, 33	1.45
16764	23, 29	2.21	17199	25	12.65	26258	29	0.31	27058	28	1.24	28200	30	0.31	31815	17, 33	1.50
16768	23, 29	2.94	17934	31	3.25	26260	29	0.31	27060	28	1.24	28201	30	0.31	31820	17, 33	1.55
16772	23, 29	4.79	17935	31	3.25	26262	29	0.46	27062	28	1.39	28202	30	0.21	31825	17, 33	1.65
16776	23, 29	6.95	17936	31	3.25	26264	29	0.46	27064	28	1.55	28203	30	0.21	31827	17, 33	1.70
16792	19, 23, 25	13.30	18032	31	0.90	26266	29	0.74	27066	28	1.96	28204	30	0.24	31830	17, 33	1.90
16799	19, 23, 25	21.75	18036	31	1.10	26268	29	0.74	27068	28	2.16	28205	30	0.24	31832	15, 33	16.35
16902	28	1.08	18037	31	1.35	26270	29	1.18	27070	28	2.99	28206	30	0.29	31834	15, 33	14.10
16903	28	1.08	18038	31	1.10	26272	29	1.18	27072	28	3.55	28207	30	0.29	31840	17, 33	2.05
16904	28	1.08	18045	31	0.90	26274	29	2.06	27074	28	4.38	28208	30	0.31	31845	17, 33	2.80
16905	28	1.13	18046	31	0.90	26276	29	2.06	27076	28	5.36	28209	30	0.31	31850	17, 33	3.50
16906	28	1.29	18099	31	1.10	26278	29	4.43	27078	28	8.86	28210	30	0.46	31855	17, 33	5.25
16907	28	1.34	20196	20	24.84	26280	29	4.43	27080	28	8.86	28211	30	0.74	31860	17, 33	6.90
16908	28	1.34	20199	20	28.20	26502	23, 27	0.99	27147	28	0.41	28212	30	0.74	32406	17, 33	4.35
16909	28	1.39	20499	13, 20	43.42	26503	23, 27	0.99	27148	28	0.41	28213	30	1.18	32407	17, 33	4.00
16910	28	1.60	20599	20	34.65	26504	23, 27	0.99	27149	28	0.28	28214	30	2.06	32408	17, 33	4.00
16911	28	1.91	20899	20	36.00	26505	23, 27	1.04	27150	28	0.31	28247	30	0.31	32409	17, 33	4.00
16912	28	2.21	22199	20	17.50	26506	23, 27	1.17	27152	28	0.31	28248	30	0.31	32410	17, 33	2.20
16913	28	3.50	22302	41	12.35	26507	23, 27	1.22	27154	28	0.40	28249	30	0.21	32415	17, 33	2.30
16914	28	4.94	22303	41	12.35	26508	23, 27	1.22	27156	28	0.40	28250	30	0.21	32420	17, 33	2.40
16915	28	9.06	22304	41	12.35	26509	23, 27	1.26	27158	28	0.46	28252	30	0.24	32425	17, 33	2.50
16916	28	11.33	22305	41	12.35	26510	23, 27	1.44	27160	28	0.46	28254	30	0.24	32427	17, 33	2.60
16917	28	14.42	22306	41	12.35	26511	23, 27	1.76	27162	28	0.72	28256	30	0.29	32430	17, 33	2.85
16918	28	16.48	22307	41	12.35	26512	23, 27	2.03	27164	28	0.72	28258	30	0.31	32432	15, 33	25.00
16919	28	24.72	22308	41	12.35	26513											

PT#	PG#	LIST EA	PT#	PG#	LIST EA	PT#	PG#	LIST EA	PT#	PG#	LIST EA	PT#	PG#	LIST EA	PT#	PG#	LIST EA
32707	33	\$2.00	34408	16	\$3.00	38076	31	\$5.46	38286	30	\$7.21	72825	33	\$2.25	75560	17, 37	\$17.90
32708	33	2.00	34409	16	3.00	38078	31	9.06	38288	30	11.95	72827	33	2.30	75702	26	1.38
32709	33	2.00	34410	16	3.00	38080	31	9.06	38292	25	6.05	72830	33	2.55	75703	26	1.38
32710	33	1.15	34415	16	3.00	38084	31	12.88	38299	25	8.90	72840	33	2.80	75704	26	1.38
32715	33	1.15	34420	16	3.00	38086	31	19.57	38602	36	2.83	72845	33	3.80	75705	26	1.44
32720	33	1.25	34445	16	24.00	38088	31	24.72	38603	36	3.09	72850	33	4.75	75706	26	1.63
32725	33	1.30	34505	17, 37	5.00	38092	19, 25	10.45	38604	36	3.50	72855	33	7.10	75707	26	1.70
32727	33	1.35	34506	17, 37	3.90	38095	19, 25	28.70	38605	36	3.50	72860	33	9.30	75708	26	1.70
32730	33	1.45	34507	17, 37	3.80	38099	19, 25	17.10	38606	36	3.61	74009	16	6.85	75709	26	1.76
32740	33	1.60	34508	17, 37	3.80	38100	30	0.72	38607	36	3.61	74010	16	7.20	75710	26	2.05
32745	33	2.00	34509	17, 37	4.10	38101	30	0.72	38608	36	4.33	74015	16	7.65	75711	26	2.46
32750	33	2.25	34510	17, 37	4.30	38102	30	0.43	38609	36	4.33	74020	16	8.00	75712	26	2.69
32755	33	3.85	34515	17, 37	4.40	38103	30	0.46	38610	36	5.67	74025	16	8.30	75713	26	3.73
32760	33	5.40	34520	17, 37	4.80	38104	30	0.46	38611	36	6.49	74027	16	8.80	75714	26	4.85
32806	33	2.60	34525	17, 37	5.30	38105	30	0.57	38612	36	6.49	74030	16	9.25	75749	26	1.38
32807	33	2.35	34527	17, 37	6.10	38106	30	0.57	38613	36	9.89	74034	13, 15	68.85	75750	26	1.38
32808	33	2.35	34530	17, 37	7.20	38107	30	0.57	38614	36	11.43	74040	16	10.40	75752	26	1.38
32809	33	2.35	34532	15, 35	34.40	38108	30	0.67	38615	36	20.70	74045	16	11.60	75754	26	1.47
32810	33	1.10	34534	15, 35	39.99	38109	30	0.67	38616	36	24.20	74050	16	13.60	75756	26	1.66
32815	33	1.20	34540	17, 37	7.85	38110	30	0.98	38632	35	26.80	74055	16	15.00	75760	26	1.76
32820	33	1.30	34545	17, 37	8.20	38111	30	1.39	38637	35	64.85	74602	36	2.47	75764	26	2.24
32825	33	1.50	34550	17, 37	9.10	38112	30	1.39	38649	36	2.83	74603	36	2.62	75768	26	2.79
32827	33	1.50	34555	17, 37	10.15	38113	30	2.32	38650	36	3.09	74604	36	2.80	75772	26	3.91
32830	33	1.70	34560	17, 37	11.20	38114	30	3.61	38652	36	3.50	74605	36	2.93	75776	26	5.29
32840	33	1.85	34706	16	3.15	38115	30	7.42	38654	36	3.50	74606	36	3.02	75902	26	1.13
32845	33	2.35	34707	16	3.15	38116	30	7.42	38656	36	3.61	74607	36	3.09	75903	26	1.13
32850	33	2.85	34708	16	3.15	38117	30	8.24	38660	36	4.33	74608	36	3.31	75904	26	1.16
32855	33	4.60	34709	16	3.15	38118	30	11.85	38664	36	5.67	74609	36	3.50	75905	26	1.22
32860	33	6.10	34710	16	3.15	38119	30	15.97	38668	36	6.49	74610	36	4.54	75906	26	1.40
33009	16	4.30	34715	16	3.15	38136	25	10.15	38672	36	9.89	74611	36	4.97	75907	26	1.45
33010	16	4.50	34720	16	3.15	38137	25	13.40	38676	36	11.43	74612	36	6.05	75908	26	1.45
33015	16	4.80	34745	16	25.05	38138	25	7.15	38686	35	24.75	74613	36	6.99	75909	26	1.50
33020	16	5.00	35006	16	3.20	38200	30	0.52	38699	35	53.55	74614	36	8.20	75910	26	1.73
33025	16	5.20	35007	16	3.20	38201	30	0.52	39146	25	6.15	74632	13, 35	24.40	75911	26	2.20
33027	16	5.50	35008	16	3.20	38202	30	0.36	39147	30	0.72	74637	13, 35	57.05	75912	26	2.42
33030	16	5.80	35009	16	3.60	38203	30	0.36	39148	30	0.72	74649	36	2.47	75913	26	3.26
33034	15	45.00	35010	16	3.60	38204	30	0.41	39149	30	0.43	74650	36	2.68	75914	26	4.34
33040	16	6.50	35015	16	3.80	38205	30	0.41	39150	30	0.46	74652	36	2.93	75949	26	1.13
33045	16	7.25	35020	16	4.20	38206	30	0.43	39152	30	0.46	74654	36	2.97	75950	26	1.13
33050	16	8.50	35045	16	27.80	38207	30	0.43	39154	30	0.57	74656	36	3.08	75952	26	1.16
33055	16	11.00	37902	31	1.08	38208	30	0.46	39156	30	0.57	74660	36	3.63	75954	26	1.25
33406	33	3.90	37903	31	1.08	38209	30	0.46	39158	30	0.67	74664	36	4.74	75956	26	1.43
33407	33	3.60	37904	31	1.08	38210	30	0.57	39160	30	0.67	74668	36	5.38	75960	26	1.50
33408	33	3.60	37905	31	1.13	38211	30	0.88	39162	30	0.98	74672	36	7.69	75964	26	1.90
33409	33	3.60	37906	31	1.29	38212	30	0.88	39164	30	0.98	74676	36	8.74	75968	26	2.52
33410	33	1.90	37907	31	1.34	38213	30	1.39	39166	30	1.39	74686	13, 35	20.75	75972	26	3.43
33415	33	1.95	37908	31	1.34	38214	30	2.32	39168	30	1.39	74699	13, 35	45.20	75976	26	4.75
33420	33	2.05	37909	31	1.39	38215	30	4.74	39170	30	2.32	74937	13, 19, 25	25.50	193102	37	8.98
33425	33	2.15	37910	31	1.60	38216	30	4.74	39172	30	2.32	74938	13, 19, 25	15.90	193103	37	8.98
33427	33	2.35	37911	31	1.91	38217	30	5.97	39174	30	3.61	74992	13, 19, 25	12.62	193104	37	8.98
33430	33	2.40	37912	31	2.21	38218	30	7.73	39176	30	3.61	74999	13, 19, 25	20.70	193105	37	8.98
33440	33	2.50	37913	31	3.50	38219	30	11.95	39178	30	7.42	75109	44	4.95	193106	37	8.51
33806	17, 37	6.50	37914	31	4.94	38236	25	7.20	39180	30	7.42	75110	44	5.29	193107	37	8.56
33807	17, 37	6.50	37915	31	9.06	38237	25	9.55	39184	30	8.24	75111	44	6.25	193108	37	9.08
33808	17, 37	6.50	37916	31	11.33	38238	25	5.90	39186	30	11.33	75112	44	6.39	193109	37	9.30
33809	17, 37	6.70	37917	31	14.42	38246	25	4.95	39188	30	14.94	75113	44	9.27	193110	37	10.25
33810	17, 37	6.70	37918	31	16.48	38247	30	0.52	39192	25	7.95	75114	44	10.12	193111	37	10.30
33815	17, 37	6.85	37919	31	24.72	38248	30	0.52	39195	25	22.60	75146	13, 43	40.85	193112	37	11.08
33820	17, 37	8.60	37936	19, 25	16.45	38249	30	0.36	39199	25	12.65	75148	13, 43	34.95	193113	37	12.03
33825	17, 37	8.65	37937	19, 25	21.05	38250	30	0.36	71809	17, 33	3.90	75160	44	5.18	193114	37	13.45
33827	17, 37	10.25	37938	19, 25	13.15	38252	30	0.39	71810	17, 33	2.20	75164	44	6.04	193115	37	14.76
33830	17, 37	12.25	38046	19, 25	7.80	38254	30	0.39	71815	17, 33	2.25	75168	44	6.57	193116	37	16.34
33832	15, 35	57.00	38049	31	1.08	38256	30	0.43	71820	17, 33	2.35	75172	44	9.40	193150	37	8.98
33834	15, 35	73.00	38050	31	1.08	38258	30	0.46	71825	17, 33	2.50	75176	44	10.21	193152	37	8.98
33840	17, 37	13.25	38052	31	1.08	38260	30	0.46	71827	17, 33	2.55	75509	17, 37	6.50	193154	37	8.98
33906	16	3.35	38054	31	1.13	38262	30	0.57	71830	17, 33	2.85	75510	17, 37	6.80	193156	37	8.56
33907	16	3.35	38056	31	1.29	38264	30	0.57	71834	13, 15, 33	21.25	75515	17, 37	7.00	193160	37	9.30
33908	16	3.35	38058	31	1.39	38266	30	0.88	71840	17, 33	3.10	75520	17, 37	7.60	193164	37	10.25
33909	16	3.75	38060	31	1.39	38268	30	0.88	71845	17, 33	4.20	75525	17, 37	8.40	193168	37	11.08
33910	16	3.75	38062	31	1.60	38270	30	1.39	71850	17, 33	5.25	75527	17, 37	9.70	193172	37	12.03
33915	16	3.95	38064	31	1.75	38272	30	1.39	71855	17, 33	7.90	75530	17, 37	11.50	193176	37	13.45
33920	16	4.35	38066	31	2.06	38274	30	2.32	71860	17, 33	10.35	75534	13, 15, 35	70.00			
33945	16	28.85	38068	31	2.32	38276	30	2.32	72809	33	3.50	75540	17, 37	12.50			
34405	16	3.00	38070	31	3.14	38278											



Torque & Interchangeability

Hex Size Inch	Torque Capacity**				Screw Interchangeability				
	Bondhus Straight Hex		Bondhus Balldriver® Tip						
	in-lb	Nm	in-lb	Nm					
.050	7.9	0.892	3	0.339	0	1, 2	1, 2	3, 4	—
1/16	15.9	1.796	7	0.0791	1	3, 4	3, 4	5, 6	—
5/64	34	3.842	13	1.469	2, 3	5, 6	5, 6	8	—
3/32	51	5.763	24	2.712	4, 5	8	8	10	—
7/64	84	9.492	39	4.407	6	10	—	—	—
1/8	129	14.57	57	6.441	—	—	10	1/4	1/4
9/64	185	20.90	86	9.718	8	1/4	—	—	—
5/32	265	29.94	127	14.35	10	5/16	1/4	5/16	5/16
3/16	431	48.7	189	21.35	1/4	3/8	5/16	3/8	3/8
7/32	673	76.04	318	35.93	—	7/16	3/8	7/16	—
1/4	950	107.3	482	54.44	5/16	1/2	—	1/2	1/2
5/16	2022	228.4	888	100.3	3/8	5/8	1/2	5/8	5/8
3/8	3005	339.5	14.88	168.1	7/16, 1/2	—	5/8	3/4	3/4
7/16	4047	457.3	1661	187.7	9/16	3/4	—	—	—
1/2	6033	681.7	2451	277.0	5/8	—	—	7/8	1
9/16	8605	972.2	3459	390.8	—	—	—	1, 1-1/8	—
5/8	11819	1335.4	4711	532.3	3/4	—	—	1-1/4, 1-3/8	1-1/4
3/4	20424	2307.6	8052	909.8	7/8, 1	—	—	1-1/2	—
Hex Size Metric	in-lb	Nm	in-lb	Nm					
1.27	7.9	.892	3	3.39	1.4	—	—	2.5	—
1.5	13.1	1.480	5	.565	1.6, 2	—	—	3	—
2	33	3.729	13	1.469	2.5	3	3	4	—
2.5	63	7.119	33	3.729	13	1.469	2.5	5	—
3	106	11.97	52	5.876	4	5	5	6	5
3.5	143	16.13	70	7.910	—	—	—	—	—
4	264	29.83	131	14.8	5	6	6	8	6
4.5	305	34.50	147	16.6	—	—	—	—	—
5	483	54.57	247	27.91	6	8	8	10	8
5.5	559	63.24	270	30.5	—	—	—	—	—
6	855	96.61	396	44.74	8	10	10	12	10
7	1090.8	123.2	549	62.1	—	—	—	—	—
8	1861	210.2	989	111.7	10	12	12	14, 16	12
9	2326	262.8	1132	128.0	—	—	—	—	—
10	3563	402.6	1591	179.7	12	14, 16	14, 16	18, 20	16
12	5103	576.6	2022	228.5	14	18, 20	18, 20	22, 24	20
14	8081	913.0	3215	363.5	16, 18	22, 24	22, 24	—	—
17	14507	1639.1	5694	643.3	20, 22	—	—	—	—
19	20285	2291.9	8052	909.8	24, 27	—	—	—	—
Star Size	Bondhus Straight Star								
	in-lb	Nm	in-lb	Nm					
T5	3.8	0.4	—	—	—	—	—	3	—
T6	6.6	0.7	4	0.45	—	2	—	4	—
T7	12	1.4	9	1.0	—	3	2	5, 6	—
T8	20	2.3	16	1.8	—	4	3	8	—
T9	25	2.8	19	2.1	—	5	4	—	—
T10	33	307	25	2.8	4, 5	6	5	10, 12	—
T15	57	6.4	41	4.6	6	8	6	—	—
T20	93	10.5	61	6.9	—	10	8	1/4	—
T25	140	15.8	85	9.6	8	12	10	—	—
T27	199	22.5	96	10.8	10, 12	1/4	12	5/16	—
T30	276	31.2	110	12.4	1/4	—	1/4	3/8	—
T40	480	54.2	363	41.0	—	5/16, 3/8	—	7/16	—
T45	763	86.2	409	46.2	5/16	—	3/8	1/2	—
T50	1171	132.3	440	49.7	3/8	7/16	7/16	—	—
T55	1931	218.2	799	90.3	7/16, 1/2	1/2	1/2	—	—

**Minimum torque capacities Bondhus tools generate without breakage.
Other manufacturer's tools may break with considerably less torque.



Discover the Bondhus Difference

#1 In Customer Service!

Here's why:

- No Minimum Orders
- No Stocking Requirements
- No Drop Ship Fees
- 97% Same-Day Order Fulfillment
- No Hassle Returns
- Lifetime Warranty
- Highly-Trained, Experienced In-House Customer Service Department
- End User Education
- Full Range of Hex & Star Products
- Free Sales Aides & Merchandisers
- Custom Manufacturing
- New Expanded Sales Hours:
7 am to 6 pm central time

Special Manufactured Products

As one of the few tool companies in the world that will do custom manufacturing, we can help you create the exact tool to fit your application or requirements.

- Call us at 800-328-8310 with your requirements. Our Customer Service Department will speak with you about:
Quantity
Tool type, length and diameter
Construction material and coating

With 35 years of experience, they can offer suggestions on the best tool configuration for your application.

- Our engineering department will quickly process your request and offer a quotation*. Upon your approval, CAD drawings will be created. A simple signoff is all that is required.
- Production will begin. Within approximately 8 weeks from final approval, your Special Manufactured Product will be shipped.

* F.O.B. Monticello, MN. Quotes are valid for 6 months. Minimum order is \$750 per line item



1-800-328-8310

1400 E. Broadway
P.O. Box 660
Monticello, MN 55362
U.S.A.

Phone 763-295-2162
Fax: 763-295-4440
E-mail: cservice@bondhus.com
Website: www.bondhus.com

©Bondhus Corporation 2006

Distributed by: