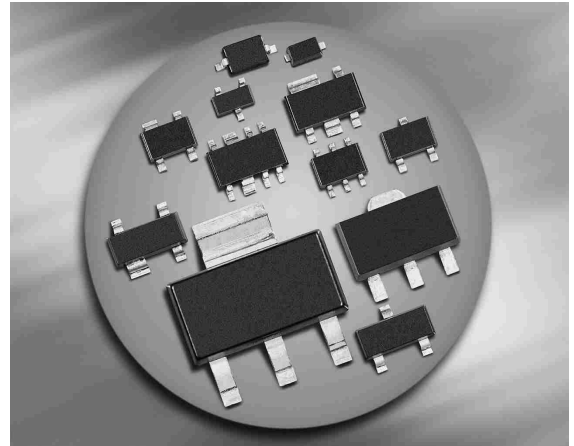
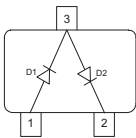
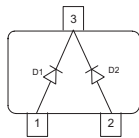
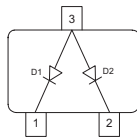
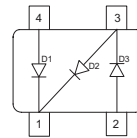

Silicon PIN Diode

- RF switch, RF attenuator for frequencies above 10 MHz
- Low distortion faktor
- Long-term stability of electrical characteristics

BAR14-1

BAR15-1

BAR16-1

BAR61

Type	Package	Configuration	L_s (nH)	Marking
BAR14-1	SOT23	series	1.8	L7s
BAR15-1	SOT23	common cathode	1.8	L8s
BAR16-1	SOT23	common anode	1.8	L9s
BAR61	SOT143	PI element	2	61s

Maximum Ratings at $T_A = 25^\circ\text{C}$, unless otherwise specified

Parameter	Symbol	Value	Unit
Diode reverse voltage	V_R	100	V
Forward current	I_F	140	mA
Total power dissipation $T_S \leq 65^\circ\text{C}$	P_{tot}	250	mW
Junction temperature	T_j	150	°C
Operating temperature range	T_{op}	-55 ... 125	
Storage temperature	T_{stg}	-55 ... 150	

Thermal Resistance

Parameter	Symbol	Value	Unit
Junction - soldering point ¹⁾	R_{thJS}	≤ 340	K/W

¹⁾For calculation of R_{thJA} please refer to Application Note Thermal Resistance

Electrical Characteristics at $T_A = 25^\circ\text{C}$, unless otherwise specified

Parameter	Symbol	Values			Unit
		min.	typ.	max.	
DC Characteristics					
Reverse current $V_R = 50\text{ V}$ $V_R = 100\text{ V}$	I_R	- -	- -	100 1000	nA
Forward voltage $I_F = 100\text{ mA}$	V_F	-	1.05	1.25	V
AC Characteristics					
Diode capacitance $V_R = 0\text{ V}, f = 100\text{ MHz}$ $V_R = 50\text{ V}, f = 1\text{ MHz}$	C_T	- -	0.2 0.25	- 0.5	pF
Zero bias conductance $V_R = 0\text{ V}, f = 100\text{ MHz}$	g_P	-	50	-	μS
Forward resistance $I_F = 0.01\text{ mA}, f = 100\text{ MHz}$ $I_F = 0.1\text{ mA}, f = 100\text{ MHz}$ $I_F = 1\text{ mA}, f = 100\text{ MHz}$ $I_F = 10\text{ mA}, f = 100\text{ MHz}$	r_f	- - - -	2800 380 45 7	- - - -	Ω
Charge carrier life time $I_F = 10\text{ mA}, I_R = 6\text{ mA}$, measured at $I_R = 3\text{ mA}$, $R_L = 100\ \Omega$	τ_{rr}	700	1000	-	ns
I-region width	W_I	-	146	-	μm

Diode capacitance $C_T = f(V_R)$

$f =$ Parameter

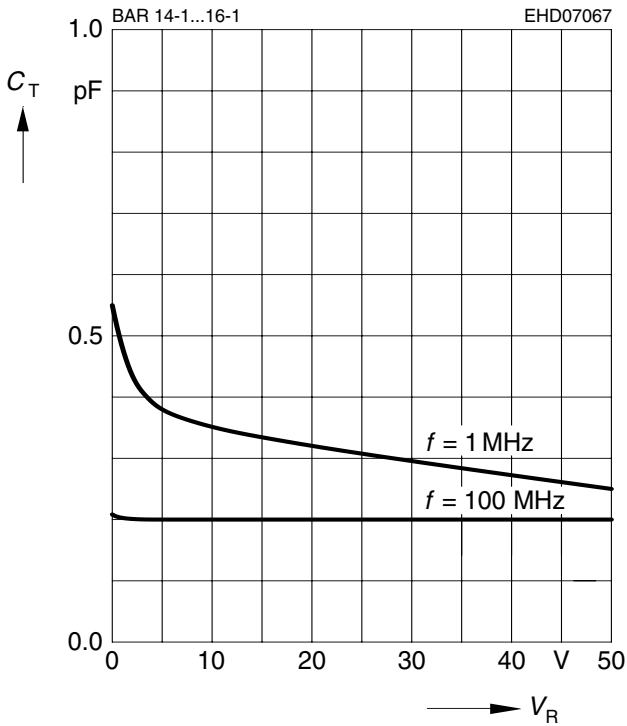

Forward resistance $r_f = f(I_F)$

$f = 100 \text{ MHz}$

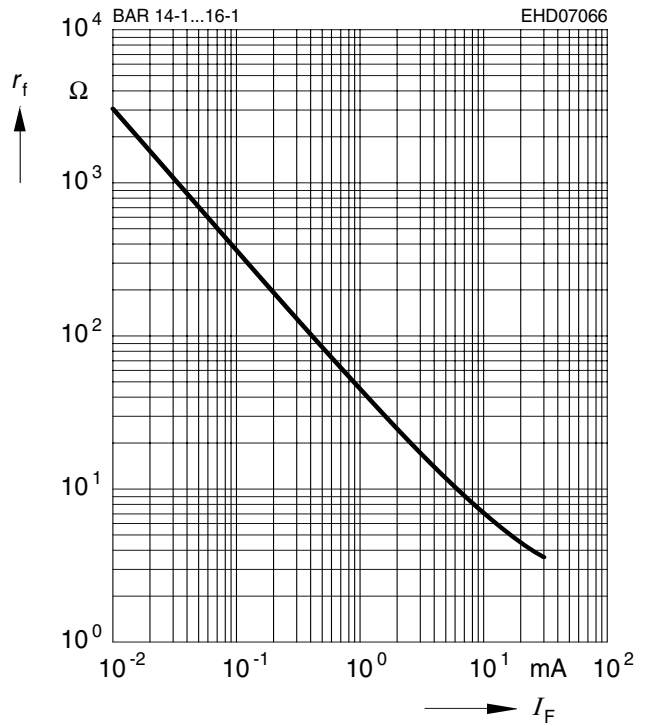

Forward current $I_F = f(V_F)$

$T_A = 25^\circ \text{C}$

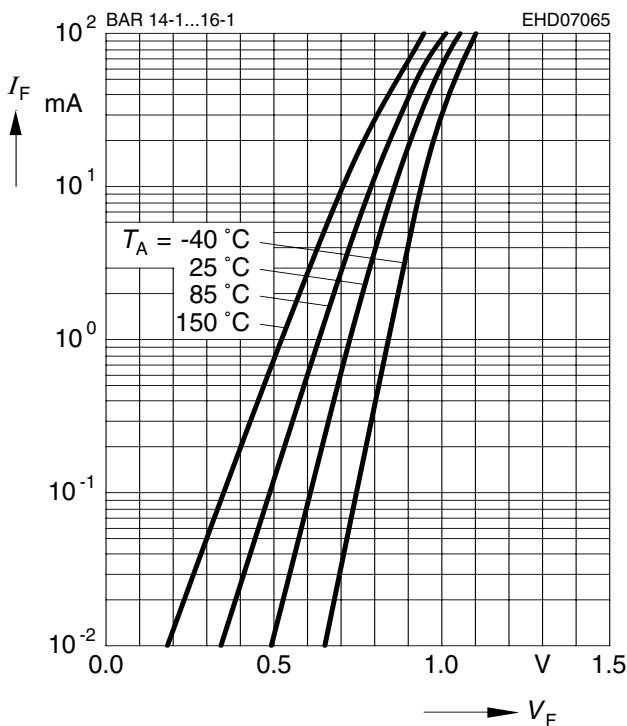

Forward current $I_F = f(T_S)$

BAR14-1, BAR15-1, BAR16-1

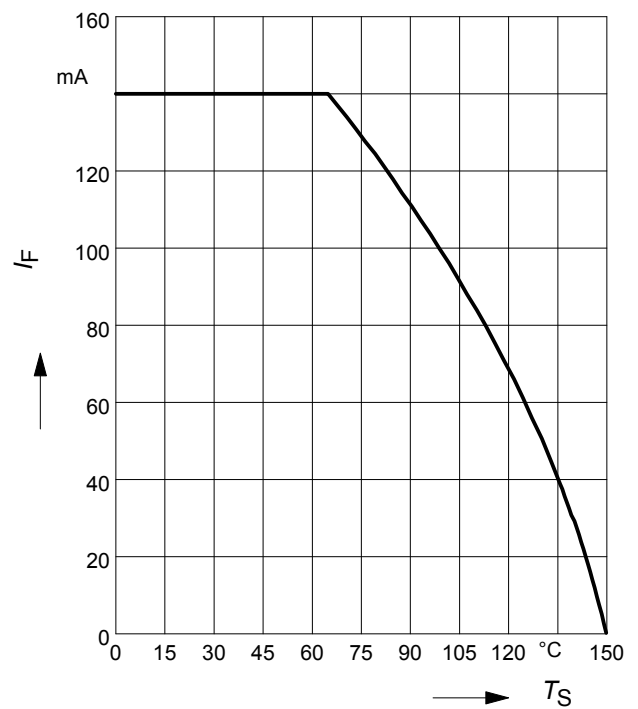

Application circuit for attenuation networks with diode BAR61

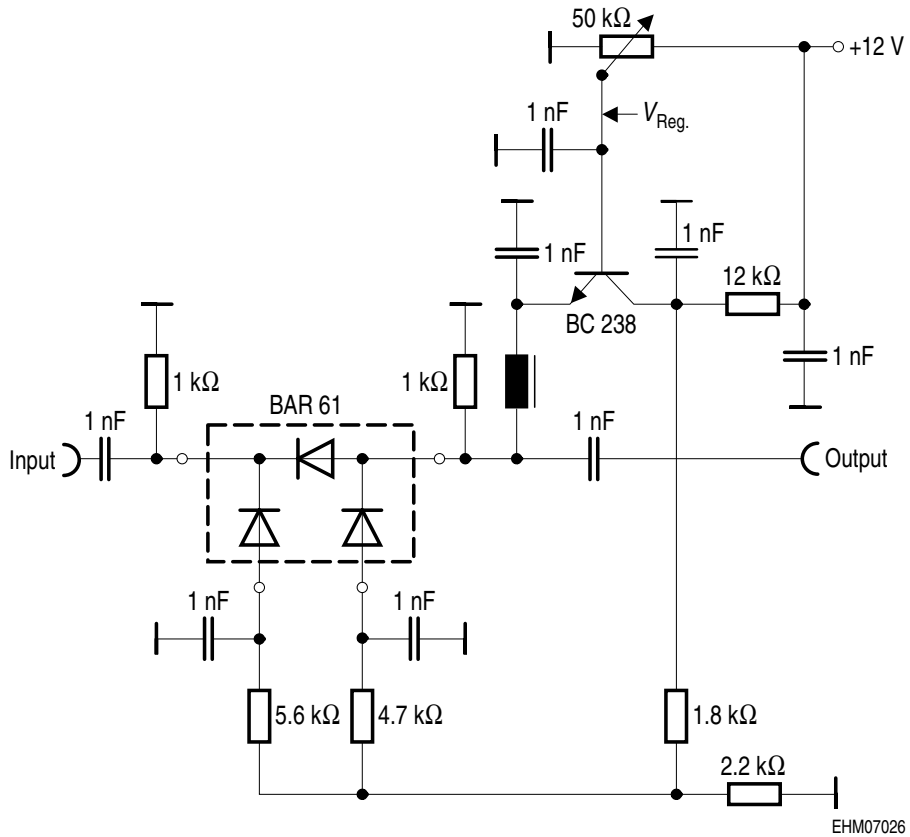

This datasheet has been download from:

www.datasheetcatalog.com

Datasheets for electronics components.