

ASMT-MxB1

1W Diffused Power LED Light Source



Data Sheet



Lead (Pb) Free
RoHS 6 fully
compliant



Description

1W Diffused Power LED Light Source is a high performance energy efficient device which can handle high thermal and high driving current. The exposed pad design has excellent heat transfer from the package to the motherboard.

The Cool White Power LED is available in various color temperature ranging from 4000K to 10000K and Warm White Power LED ranging from 2600K to 4000K. The product has high Color Rendering Index (CRI) which provides excellent color perception and visual clarity.

The low profile package design is suitable for a wide variety of applications especially where height is a constraint.

The package is compatible with reflow soldering. This will give more freedom and flexibility to the light source designer.

Applications

- Portable (flash light, bicycle head light)
- Reading light
- Architectural lighting
- Garden lighting
- Decorative lighting

Features

- Available in Cool White and Warm White color
- Energy efficient
- Exposed pad for excellent heat transfer
- This part is optically matched with Avago's collimating lenses, i.e. ASMT-M0xx. It should be used together with these lenses for improved color uniformity.
- Suitable for reflow soldering process
- High current operation
- Long operation life
- Wide viewing angle
- Silicone encapsulation
- ESD of 16kV
- MSL 2A

Specifications

- InGaN Technology
- 3.6V, 350 mA (typical)
- 110 viewing angle

Package Dimensions

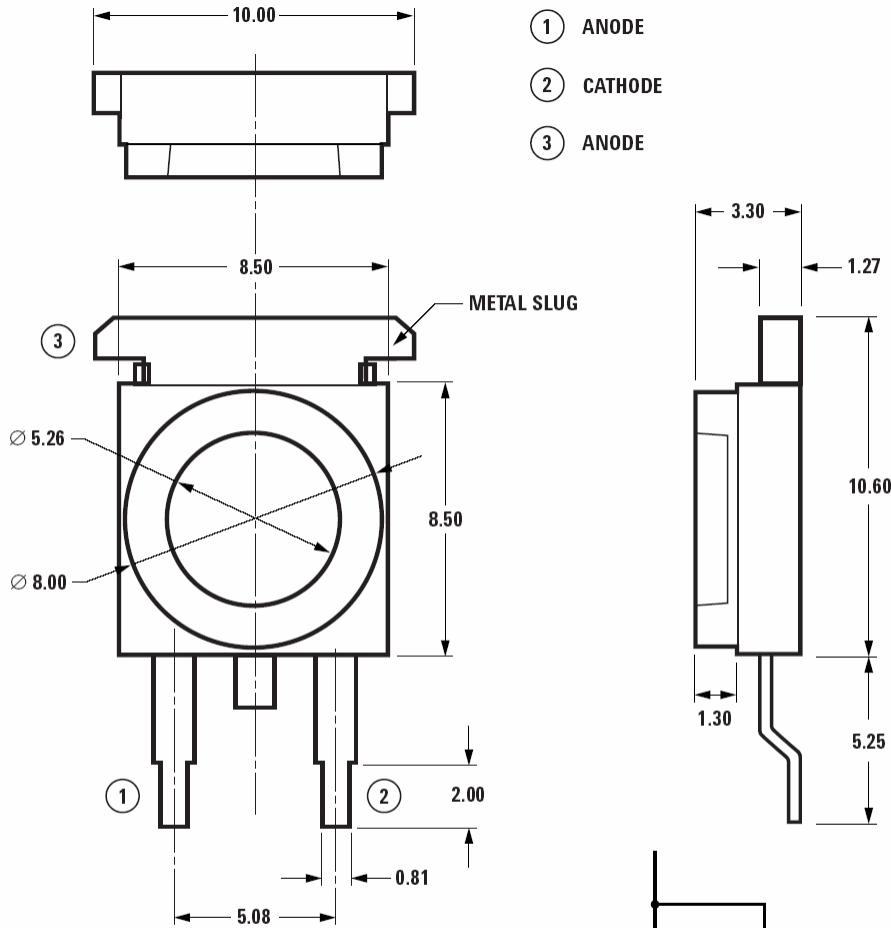

- NOTES:
1. ALL DIMENSIONS IN MILLIMETERS.
2. TOLERANCE IS ± 0.1 mm UNLESS OTHERWISE SPECIFIED.

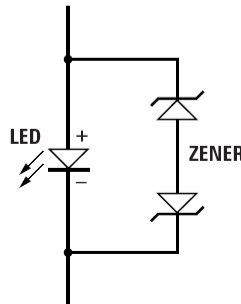

Device Selection Guide at Junction Temperature $T_j = 25^\circ\text{C}$

Color	Part Number	Luminous Flux, $\Phi_v^{[1,2]}$ (lm)			Test Current (mA)	Dice Technology
		Min	Typ	Max		
Cool White Diffused	ASMT-MWB1	43.0	55.0	73.0	350	InGaN
Warm White Diffused	ASMT-MYB1	43.0	46.0	73.0	350	InGaN

Notes:

- Φ_v is the total luminous flux output as measured with an integrating sphere at 25ms mono pulse condition.
- Flux tolerance is $\pm 10\%$

Part Numbering System

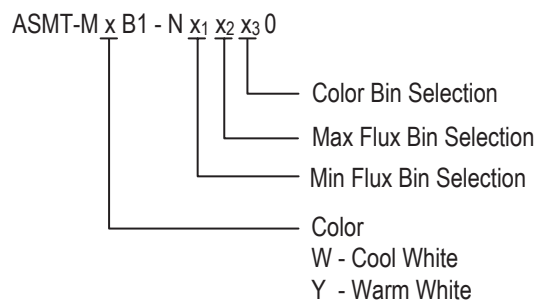

Absolute Maximum Ratings at $T_A = 25^\circ\text{C}$

Parameter	ASMT-MxB1	Units
DC Forward Current ^[1]	350	mA
Peak Pulsing Current ^[2]	500	mA
Power Dissipation	1400	mW
LED Junction Temperature	110	$^\circ\text{C}$
Operating Ambient Temperature Range	-40 to +85	$^\circ\text{C}$
Storage Temperature Range	-40 to +100	$^\circ\text{C}$
Soldering Temperature	Refer to figure 6	

Note:

- DC forward current – derate linearly based on Figure 5.
- Pulse condition duty factor = 10%, Frequency = 1kHz.

Optical Characteristics ($T_A = 25^\circ\text{C}$)

Part Number	Color	Correlated Color Temperature, CCT (Kelvin)		Viewing Angle $2\theta_{1/2}$ ^[1] (Degrees)	Luminous Efficiency (lm/W)
		Min.	Max.	Typ.	Typ.
ASMT-MWB1	Cool White Diffused	4000	10000	110	44
ASMT-MYB1	Warm White Diffused	2600	4000	110	37

Notes:

- $\theta_{1/2}$ is the off-axis angle where the luminous intensity is $1/2$ the peak intensity.

Electrical Characteristic ($T_A = 25^\circ\text{C}$)

Dice Type	Forward Voltage V_F (Volts) @ $I_F = 350\text{mA}$		Reverse Voltage V_R (Volts)	Thermal Resistance $R_{\theta_{j-ms}}$ ($^\circ\text{C/W}$) ^[1]
	Typ	Max.	Max.	Typ.
InGaN	3.6	4.0	5.0	10

Note:

- $R_{\theta_{j-ms}}$ is Thermal Resistance from LED junction to metal slug.

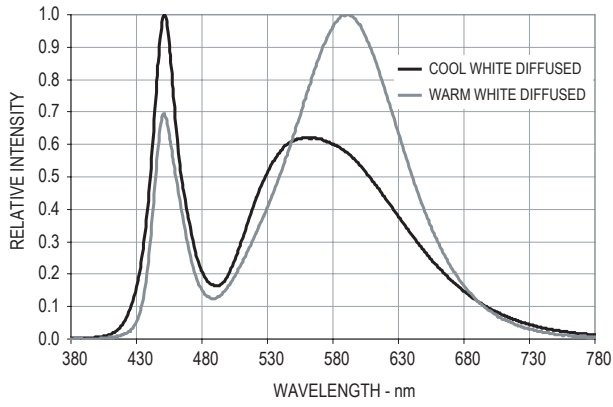

Figure 1. Relative intensity vs. wavelength

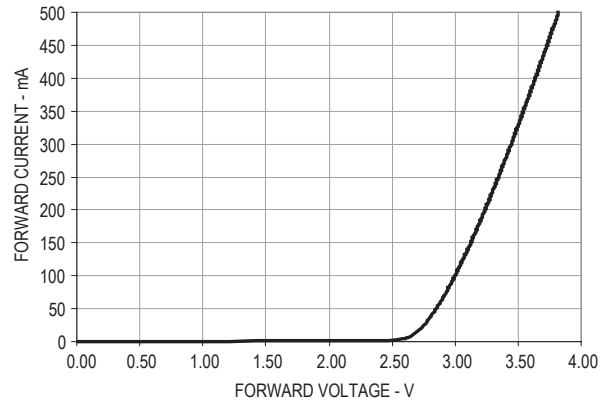

Figure 2. Forward Current vs Forward Voltage

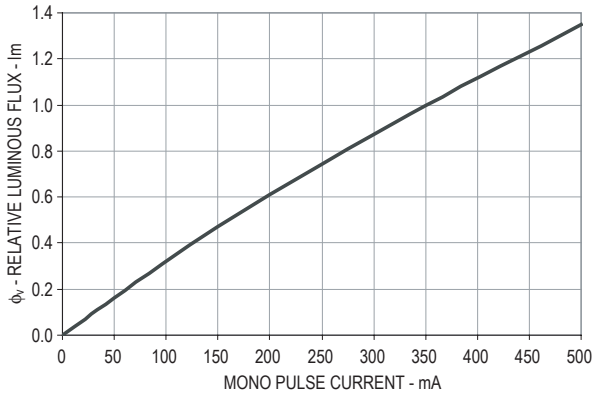

Figure 3. Relative Luminous Flux vs. Mono Pulse Current

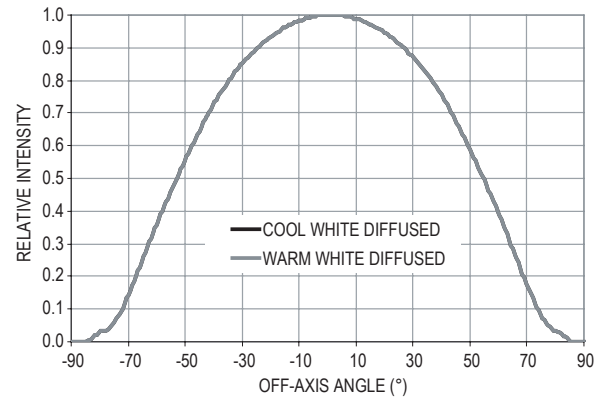

Figure 4. Radiation Pattern

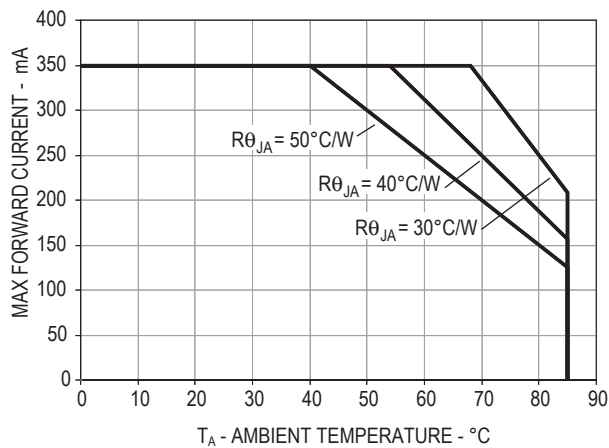

Figure 5. Maximum forward current vs. ambient temperature
Derated based on $T_{JMAX} = 110^{\circ}C$, $R_{\theta JA} = 30^{\circ}C/W / 40^{\circ}C/W$ and $50^{\circ}C/W$

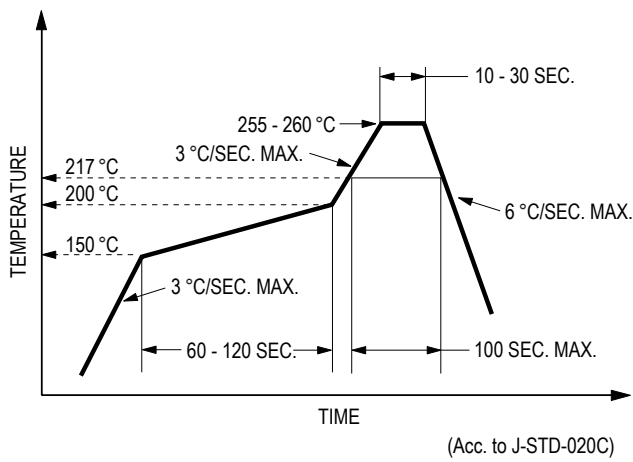

Figure 6. Recommended Reflow Soldering

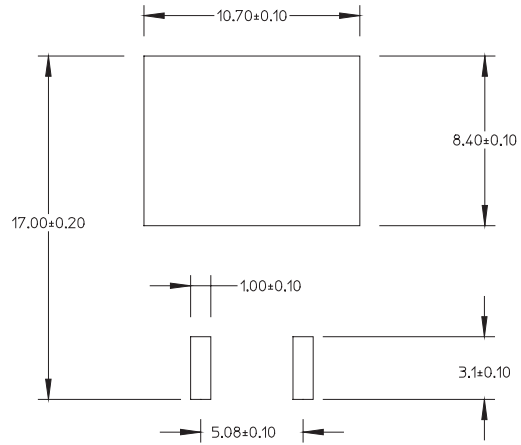

Figure 7. Recommended soldering land pattern

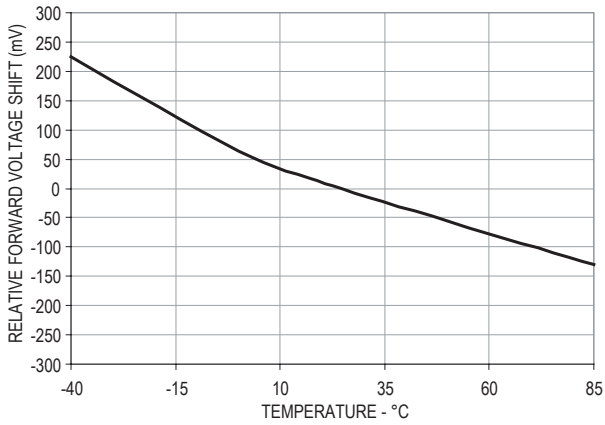

Figure 8. Temperature vs. relative forward voltage shift

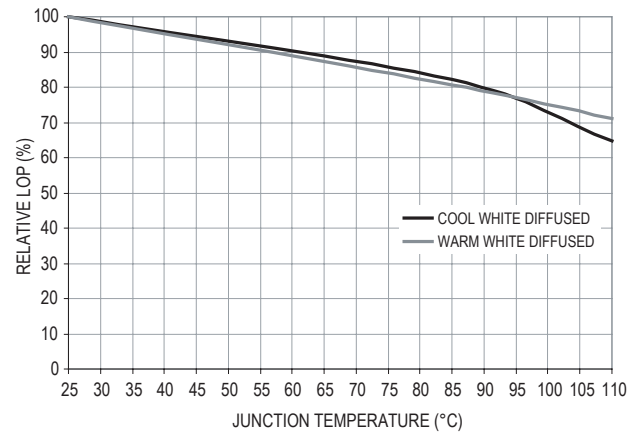

Figure 9. Relative LOP vs. junction temperature

Flux Bin Limit (For reference only) [X₁ X₂]

Bin	Flux (lm) at 350mA	
	Min	Max
J	43.0	56.0
K	56.0	73.0

Tolerance for each bin limits is $\pm 10\%$

Color Bin Selections [X₃]

Individual reel will contain parts from one full bin only.

Cool White

O	Full Distribution
A	A only
B	B only
C	C only
D	D only
E	E only
F	F only
G	G only
H	H only
Z	A and B only
Y	B and C only
W	C and D only
V	D and E only
U	E and F only
T	F and G only
S	G and H only
Q	A, B and C only
P	B, C and D only
N	C, D and E only
M	D, E and F only
L	E, F and G only
K	F, G and H only
J	Special Color Bin
1	A, B, C and D only
2	E, F, G and H only
3	B, C, D and E only
4	C, D, E and F only
5	A, B, C, D and E only
6	B, C, D, E, and F only

Warm White

O	Full Distribution
A	A only
B	B only
C	C only
D	D only
E	E only
F	F only
Z	A and B only
Y	B and C only
W	C and D only
V	D and E only
U	E and F only
Q	A, B and C only
P	B, C and D only
N	C, D and E only
M	D, E and F only
J	Special Color Bin
1	A, B, C and D only
2	E, F, G and H only
3	B, C, D and E only
4	C, D, E and F only
5	A, B, C, D and E only
6	B, C, D, E, and F only

Color Limits

Cool White	Color Limits (Chromaticity Coordinates)				
Bin A	X	0.367	0.362	0.329	0.329
	Y	0.400	0.372	0.345	0.369
Bin B	X	0.362	0.356	0.329	0.329
	Y	0.372	0.330	0.302	0.345
Bin C	X	0.329	0.329	0.305	0.301
	Y	0.369	0.345	0.322	0.342
Bin D	X	0.329	0.329	0.311	0.305
	Y	0.345	0.302	0.285	0.322
Bin E	X	0.303	0.307	0.283	0.274
	Y	0.333	0.311	0.284	0.301
Bin F	X	0.307	0.311	0.290	0.283
	Y	0.311	0.285	0.265	0.284
Bin G	X	0.388	0.379	0.362	0.367
	Y	0.417	0.383	0.372	0.400
Bin H	X	0.379	0.369	0.356	0.362
	Y	0.383	0.343	0.330	0.372

Tolerances ± 0.01

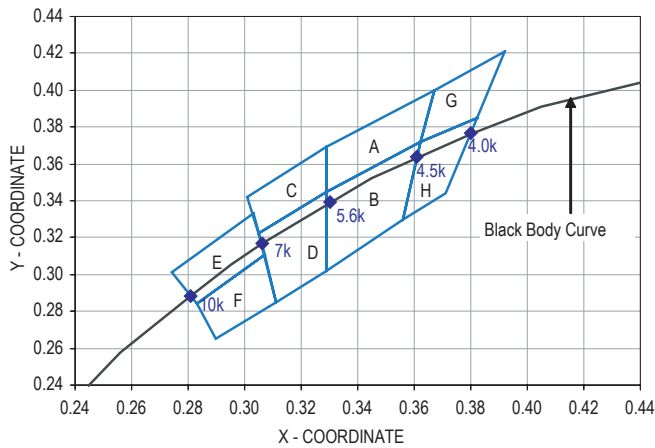

Warm White	Color Limits (Chromaticity Coordinates)				
Bin A	X	0.452	0.488	0.470	0.438
	Y	0.434	0.447	0.414	0.403
Bin B	X	0.438	0.470	0.452	0.424
	Y	0.403	0.414	0.384	0.376
Bin C	X	0.407	0.418	0.452	0.438
	Y	0.393	0.422	0.434	0.403
Bin D	X	0.395	0.407	0.438	0.424
	Y	0.362	0.393	0.403	0.376
Bin E	X	0.381	0.387	0.418	0.407
	Y	0.377	0.404	0.422	0.393
Bin F	X	0.373	0.381	0.407	0.395
	Y	0.349	0.377	0.393	0.362

Tolerances ± 0.01

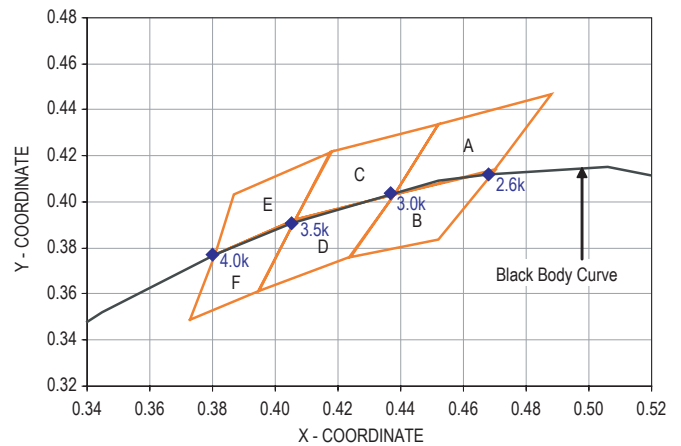

Sub-Color Binning

(Only Applicable for Color Bin A to Bin D and Bin G to Bin H)

Cool White	Color Limits (Chromaticity Coordinates)				
Bin A1	X	0.364	0.367	0.348	0.347
	Y	0.383	0.400	0.385	0.372
Bin A2	X	0.364	0.362	0.346	0.347
	Y	0.383	0.372	0.359	0.372
Bin A3	X	0.329	0.329	0.348	0.347
	Y	0.357	0.369	0.385	0.372
Bin A4	X	0.329	0.329	0.347	0.346
	Y	0.345	0.357	0.372	0.359
Bin B1	X	0.362	0.360	0.344	0.346
	Y	0.372	0.357	0.344	0.359
Bin B2	X	0.360	0.358	0.343	0.344
	Y	0.357	0.343	0.331	0.344
Bin B3	X	0.358	0.356	0.341	0.343
	Y	0.343	0.330	0.314	0.331
Bin B4	X	0.329	0.329	0.346	0.344
	Y	0.331	0.345	0.359	0.344
Bin B5	X	0.329	0.344	0.343	0.329
	Y	0.331	0.344	0.331	0.320
Bin B6	X	0.343	0.341	0.329	0.329
	Y	0.331	0.314	0.302	0.320
Bin C1	X	0.329	0.329	0.315	0.314
	Y	0.369	0.357	0.344	0.355
Bin C2	X	0.329	0.329	0.316	0.315
	Y	0.357	0.345	0.333	0.344
Bin C3	X	0.314	0.315	0.303	0.301
	Y	0.355	0.344	0.333	0.342
Bin C4	X	0.315	0.316	0.305	0.303
	Y	0.344	0.333	0.322	0.333

Cool White	Color Limits (Chromaticity Coordinates)				
Bin D1	X	0.329	0.329	0.317	0.316
	Y	0.345	0.331	0.320	0.333
Bin D2	X	0.329	0.329	0.318	0.317
	Y	0.331	0.320	0.310	0.320
Bin D3	X	0.329	0.329	0.320	0.318
	Y	0.320	0.302	0.293	0.310
Bin D4	X	0.316	0.317	0.307	0.305
	Y	0.333	0.320	0.311	0.322
Bin D5	X	0.317	0.318	0.309	0.307
	Y	0.320	0.310	0.300	0.311
Bin D6	X	0.318	0.320	0.311	0.309
	Y	0.310	0.293	0.285	0.300
Bin G1	X	0.392	0.386	0.364	0.367
	Y	0.421	0.400	0.383	0.400
Bin G2	X	0.386	0.382	0.362	0.364
	Y	0.400	0.385	0.372	0.383
Bin H1	X	0.382	0.378	0.360	0.362
	Y	0.385	0.370	0.357	0.372
Bin H2	X	0.378	0.375	0.358	0.360
	Y	0.370	0.358	0.343	0.357
Bin H3	X	0.375	0.371	0.356	0.358
	Y	0.358	0.344	0.330	0.343

Tolerances ± 0.01

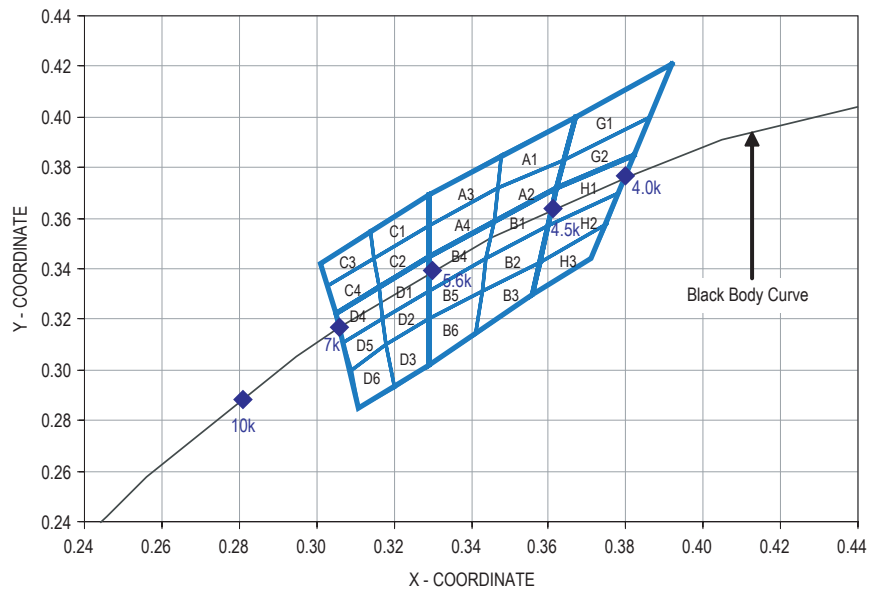

Package Tube Dimensions

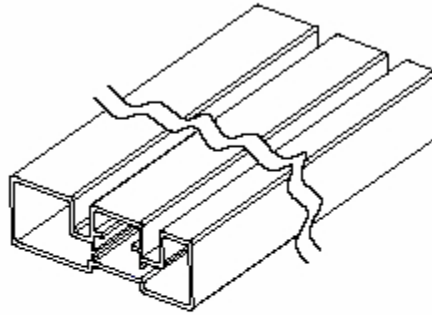
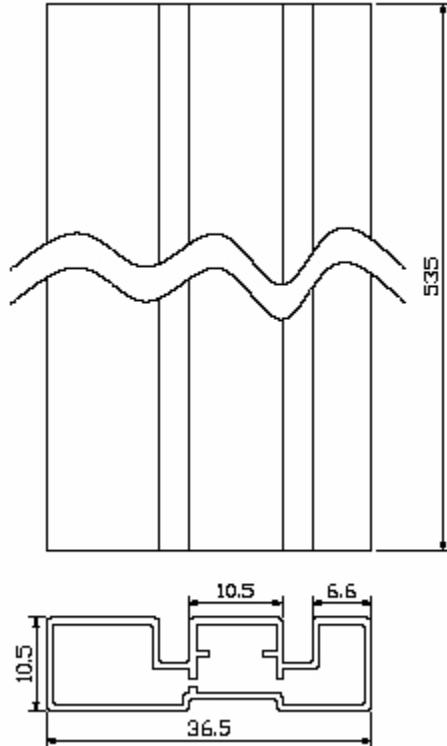

Handling Precaution

The encapsulation material of the product is made of silicone for better reliability of the product. As silicone is a soft material, please do not press on the silicone or poke a sharp object onto the silicone. These might damage the product and cause premature failure. During assembly or handling, the unit should be held on the body (white epoxy).

Moisture Sensitivity

This product is classified as moisture sensitive level 2A

When the bag is opened, parts required to mount within 672 hours of factory conditions $\leq 30^{\circ}\text{C}/60\%$, and stored at $<10\%$ RH.

Devices required bake, before mounting if:

- The humidity indicator card is $>10\%$ when read at $23\pm 5^{\circ}\text{C}$
- The pack has been opened for more than 672 hours.
Baking recommended condition: $60\pm 5^{\circ}\text{C}$ for 20 hours.

DISCLAIMER: AVAGO'S PRODUCTS AND SOFTWARE ARE NOT SPECIFICALLY DESIGNED, MANUFACTURED OR AUTHORIZED FOR SALE AS PARTS, COMPONENTS OR ASSEMBLIES FOR THE PLANNING, CONSTRUCTION, MAINTENANCE OR DIRECT OPERATION OF A NUCLEAR FACILITY OR FOR USE IN MEDICAL DEVICES OR APPLICATIONS. CUSTOMER IS SOLELY RESPONSIBLE, AND WAIVES ALL RIGHTS TO MAKE CLAIMS AGAINST AVAGO OR ITS SUPPLIERS, FOR ALL LOSS, DAMAGE, EXPENSE OR LIABILITY IN CONNECTION WITH SUCH USE.

For product information and a complete list of distributors, please go to our web site: www.avagotech.com

Avago, Avago Technologies, and the A logo are trademarks of Avago Technologies, Limited in the United States and other countries. Data subject to change. Copyright © 2007 Avago Technologies Limited. All rights reserved.
AV02-0508EN - September 21, 2007