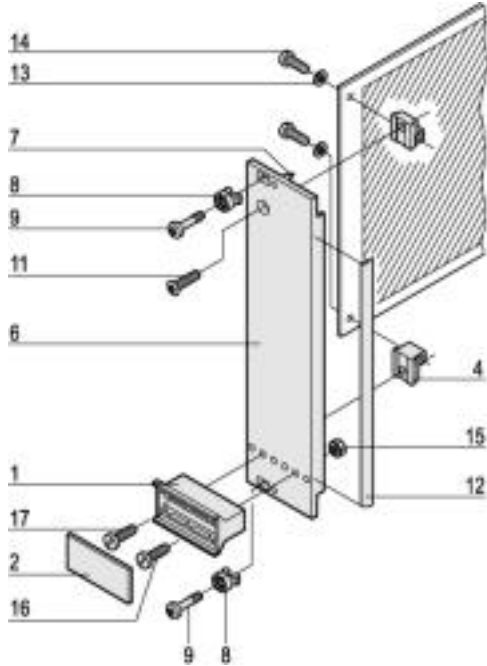

Plug-in unit with handle, shielded
[Print page](#)

3 U

Article number: 20848-669

- Handle without extraction function
- Front panel shielded

Delivery comprises: kit

Item	Qty	Description
1	1	Plastic handle, trapezium shape, PPE, grey
2	1	Identification plate, Al, 1.5 mm, anodised, cut edges plain
4	2	Printed board bracket, Zn, die-cast
6	1	U front panel for trapeziform handle, Front anodised, rear iridescent green chromated
7	2	Alignment pin, pressed-in, stainless steel
8	2	Sleeve, PA, grey, up to 7 HP front panel width
8	4	Sleeve, PA, grey, from 8 HP front panel width
9	2	Pozidrive/slotted collar screw, St, nickel-plated, M2.5 x 11 and 12.3, up to 7 HP front panel width
9	4	Pozidrive/slotted collar screw, St, nickel-plated, M2.5 x 11 and 12.3, from 8 HP front panel width
11	1	Raised countersunk screw, St, nickel-plated, M2.5 x 8
12	1	EMC textile seal
13	2	Washer, A2.7, DIN 125
14	2	Flathead screw, St, nickel-plated, M2.5 x 10
15	1	Hexagon nut, St, nickel-plated, M2.5
16	1	Flathead screw, St, nickel-plated, M2.5 x 12
17	1	Flathead screw, St, nickel-plated, M2.5 x 16

Technical data:

Height	Width
3 U	10 HP

Further Information:

	User Manual User Manual User Manual
---	---