

208-693 to 209-065

Series 636 IDC System

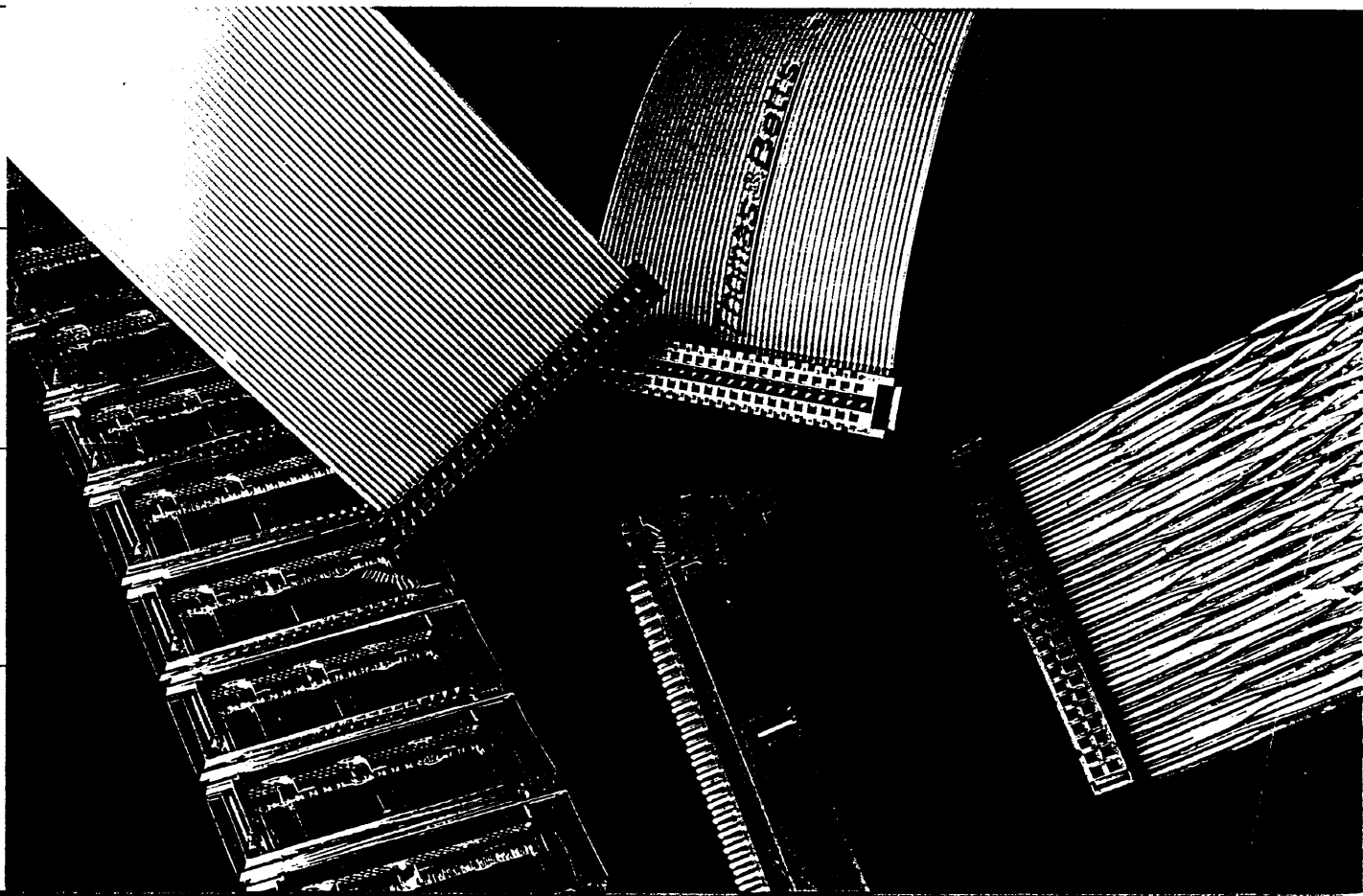

INTRODUCTION

The 636 series IDC Connector programme from Thomas & Betts has been introduced to meet the needs of specific users in the Telecom, Computer, Office Equipment and Commercial Electronics Markets. This latest system includes a broad range of female sockets, PCB lock and eject headers, card edge and solder transition connector types.

All 636 series cable mounted connectors are fully compatible with existing Thomas & Betts hand, bench, semi-automated and fully automated tooling, ensuring the lowest applied cost.

This new connector system is manufactured from the highest quality materials and offers UL/CSA approvals and certifications. Mating compatibility to industry Standards such as MIL-C-83503, DIN 41651, BS9525 and UTE C93-428 are fully supported by the 636 Series Connector System.

The 636 connector series is manufactured using state of the art production techniques and incorporates the latest procedures of statistical process control. The highest levels of quality are maintained for all applications of the System.

As with all Thomas & Betts components, proper material selection combined with computer aided design, provide the user with a high performance connector system which if installed today, will continue to provide reliable service for years to come.

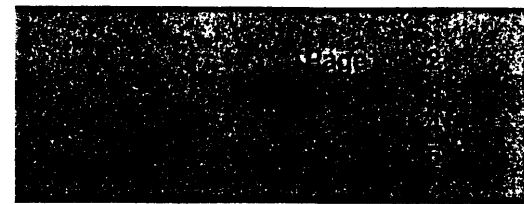
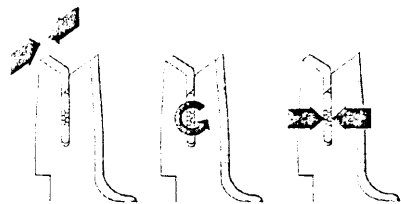
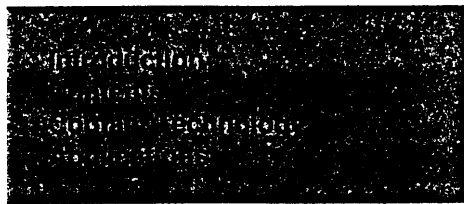

**Semi-Automated Modular
Assembly Systems
Fully Automatic Harness
Machines**

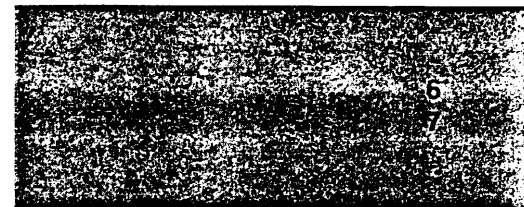
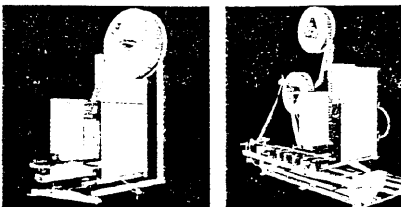

**Female Socket
Connector
6 - 64 Position**

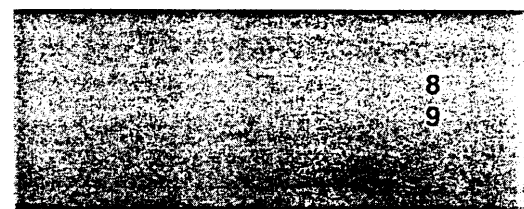
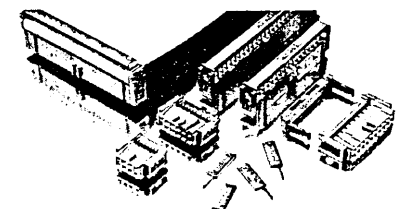

**PCB Header
MIL-C-83503
DIN 41651
BS9525F0023
HE 10**

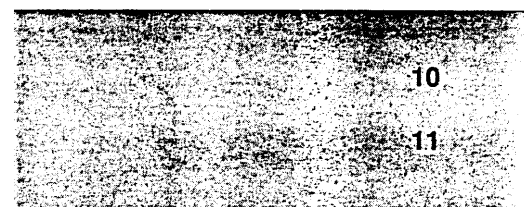
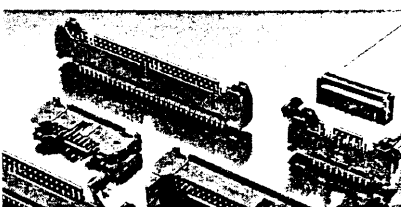

Card Edge Connector

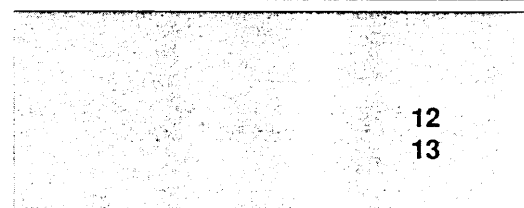
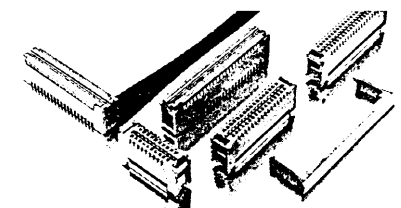

**PC Board Mounted
Solder Transition Connector**

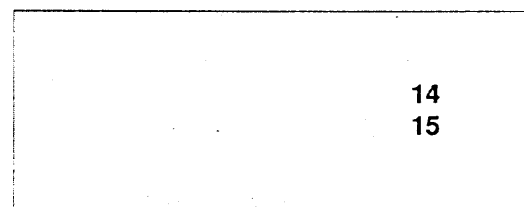

**Cable
171-XX
179-XX
178-XX**

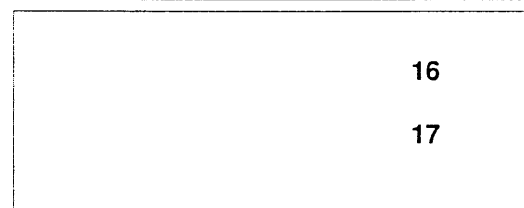

**Connector Packaging
for Auto Assembly
Systems**

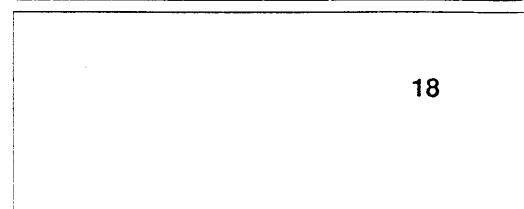
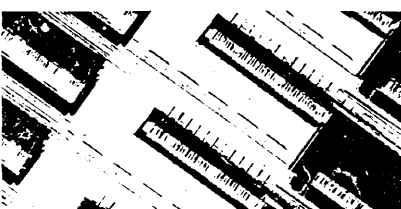

Index

Cat. No.	Page	Cat. No.
171-XX	16	636-XX01
173-XX	16	636-XX04E/ES
178-XX	16	636-XX05
178-XX	16	636-XX14E/ES
179-XX	16	636-XX15
622-XX33	14	636-2015G3P02
636-0000	8-9	636-3415G3P02

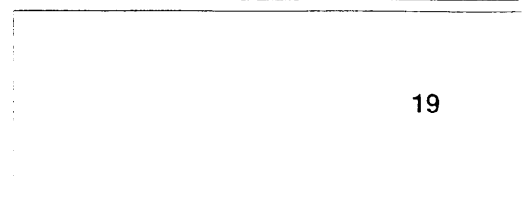

IDC Systems for today's high volume commercial applications needn't sacrifice performance or quality for cost efficiency.

In the new 636 IDC System, materials and plating surfaces are matched to the applications, without effect to component reliability, a level you've come to expect of Thomas & Betts.

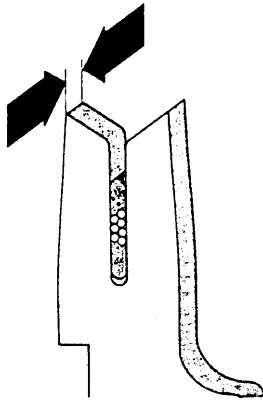
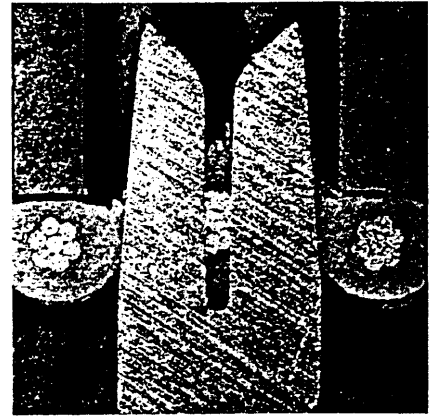

**Contact Material Thickness:
0,3 mm**

contact thickness has been selected. The resulting contact is at least twice the cross-sectional area of a terminated solid wire.

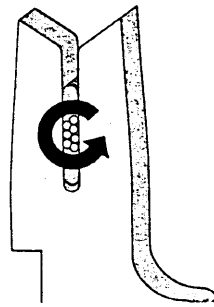

**Contact-to-Conductor
Relationship**

T&B mass-termination connectors are designed to position the terminated conductors within a specified region. We refer to this special termination region as the 'Critical Zone'.

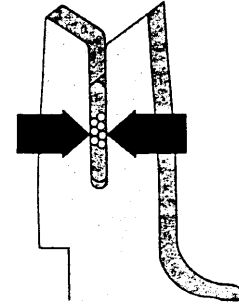

Conductor Location

Positioning the conductors within the 'Critical Zone', assures the optimum conductor deformation, maintaining proper contact pressure and preventing the potential for contact set or over-stress.

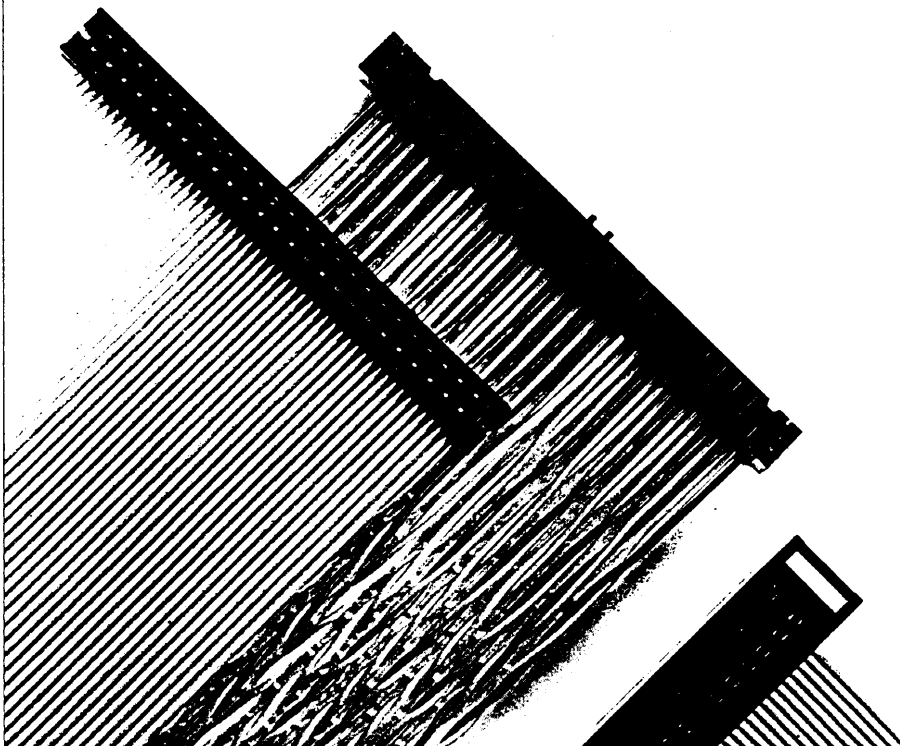

Thomas & Betts insulation displacement connectors and flat cables are designed as a system able to be matched to specific interconnection needs. A variety of cable structures from standard PVC cables to high performance types can be selected.

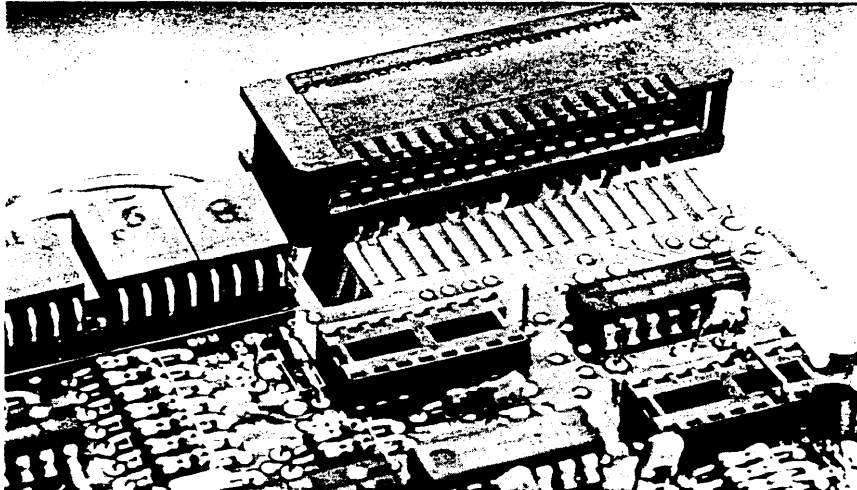
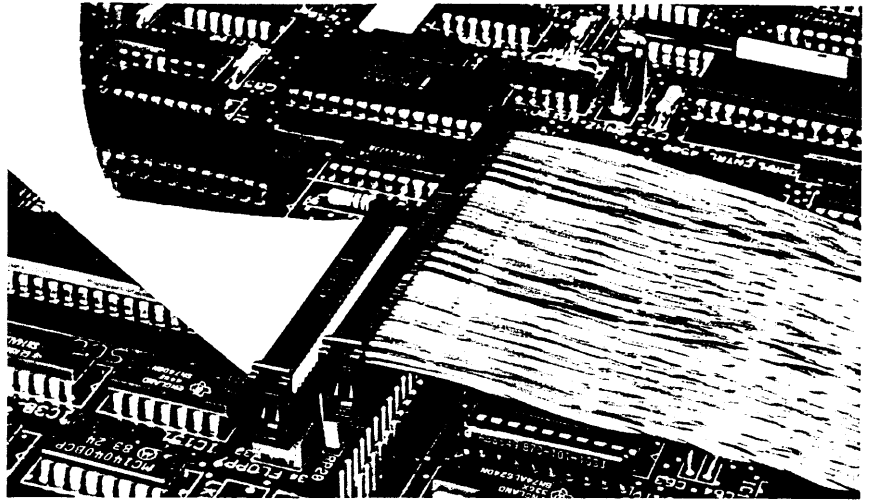

Wire-to-board interconnections can be achieved with either header and socket connector pairs or with direct edge connections as shown.

Multiple-connector flat cable harness assemblies can provide a cost and space efficient means of interconnecting a multi-board system.

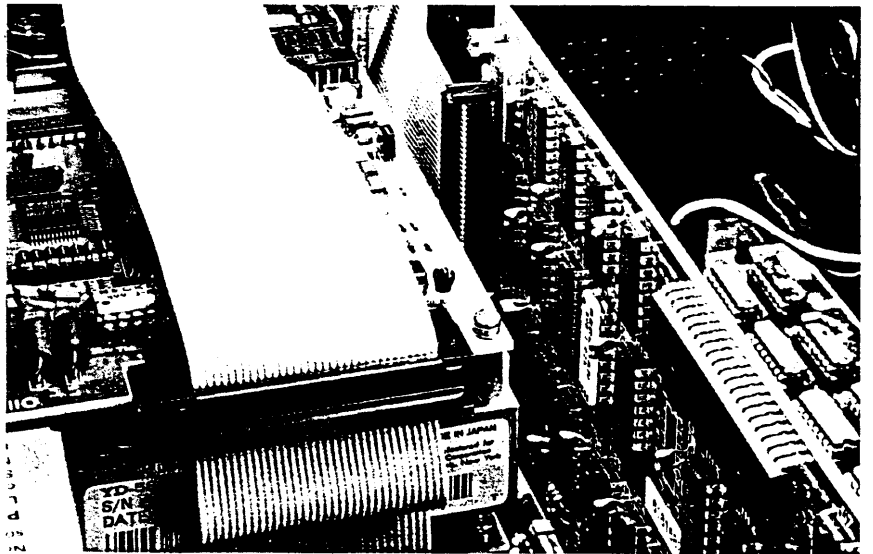

**T&B MODULAR
ASSEMBLY SYSTEMS**

The endless varieties of flat cable harness configurations demand a high degree of assembly versatility to make maximum use of the connector system.

Thomas & Betts has developed a new range of flat cable harness assembly systems, designed to provide virtually unlimited harness style flexibility. These developments answer growing needs to improve volume capability, while replacing operator variables with repeatable accuracy.

Assembly systems are available in single or multiple feed semi-automatic configurations or as fully automated systems for automatic test and termination capability.

Thomas & Betts assembly systems feed bandolier packaged connectors, eliminating manual connector handling and orientation, while controlling alignment, measurement and termination operations during each cycle.

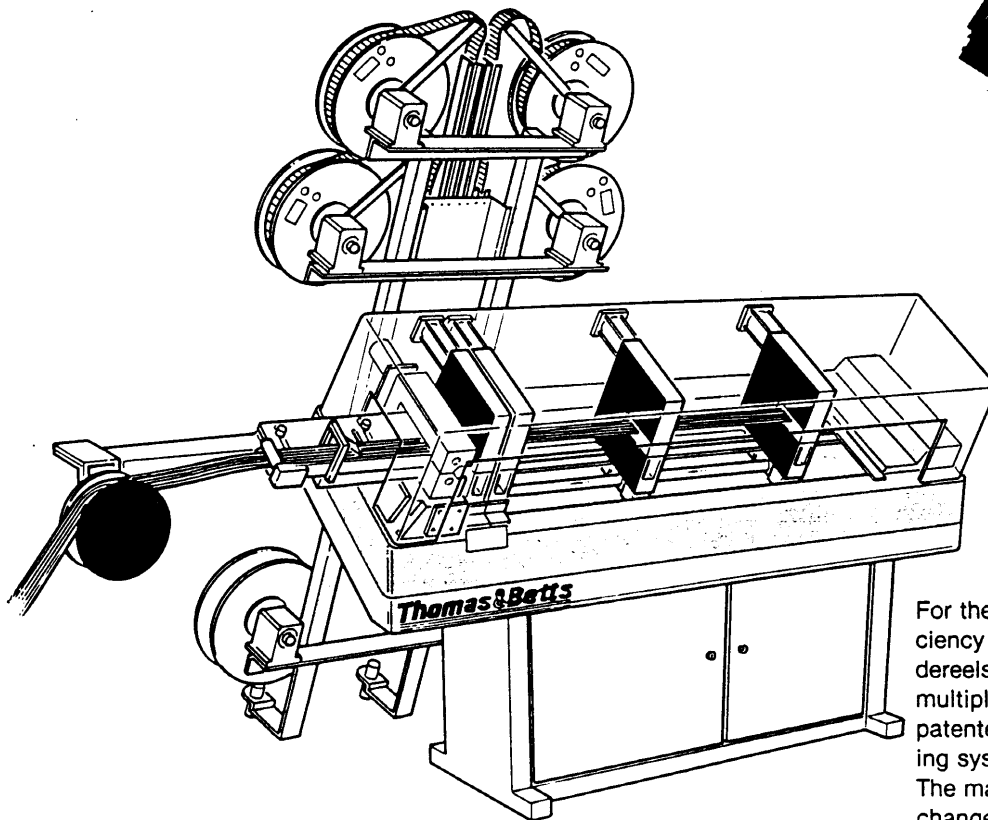
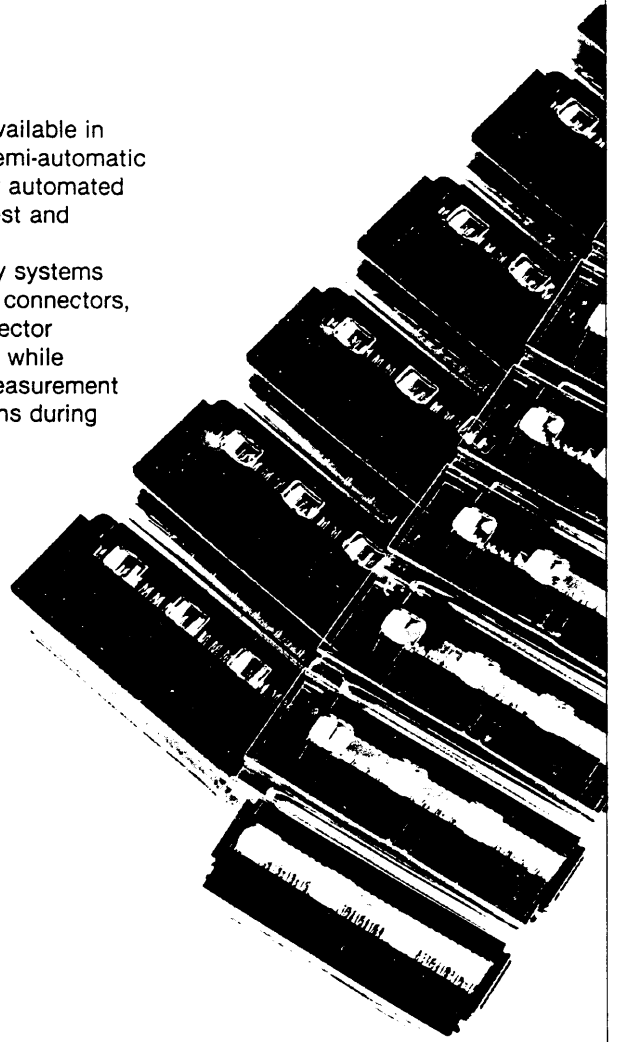

For the highest level of assembly efficiency the 779-9500 harness machine dereels and measures cable, applies multiple connectors and features the patented bandolier connector packaging system from Thomas & Betts. The machine incorporates quick change-over tooling and in-line testing for open or short circuits. Programmable operation will allow up to 700 completed assemblies to be produced per hour in various configurations.

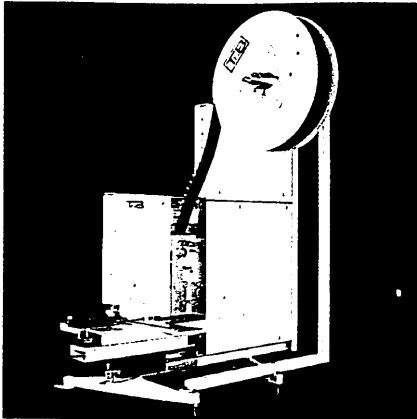

SINGLE FEED ASSEMBLY SYSTEM

779-7100 allows automatic connector indexing and termination for pre-cut cable lengths. One tooling set accommodates all products within a series, and can easily be changed-over for other product types.

- Sliding shuttle provides positive cable-to-connector location.
- Connector termination is automatically controlled by cable shuttle.
- 500 connector bandolier reel enables 1 hour (approx.) production before changeover.

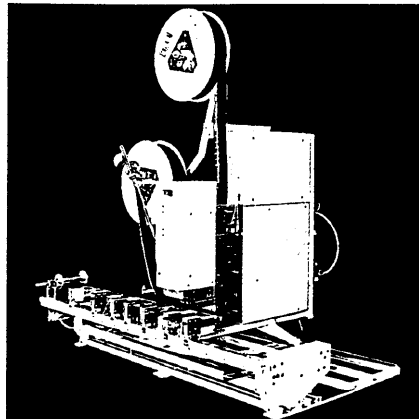

DUAL FEED ASSEMBLY SYSTEM

779-7200 is ideally suited for larger volume production requirements; specifically for double end harness assemblies. Two connector terminations are made simultaneously, achieving lower assembly costs.

- Cable dereeling/measurement shuttle ensures accurate cable alignment, connector assembly and handling.
- Machine is easily activated by fingertip-touch controls.
- Average production speed: 500 double ended harnesses per hour.

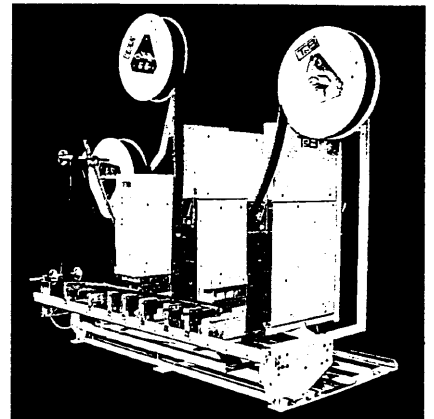

TRIPLE FEED ASSEMBLY SYSTEM

For a high-level of assembly versatility, the 779-7300 terminates up to three connectors in one cycle. The operator can select simple or complex daisychain assemblies of similar or mixed connector styles.

- Cable dereeling/measurement shuttle speeds assembly handling and assures positive alignment.
- Fingertip actuation is user-friendly.
- Average 500 triple connector harness assemblies per hour.

HARNESS ASSEMBLY OPTIONS

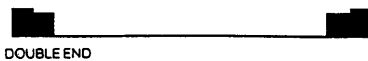
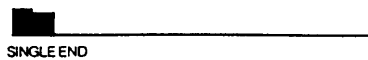

HARNESS ASSEMBLY OPTIONS

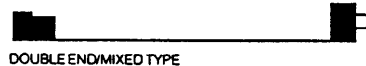
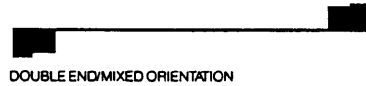
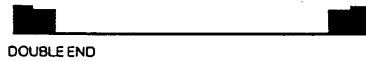
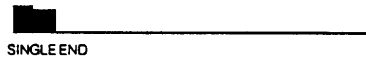

HARNESS ASSEMBLY OPTIONS

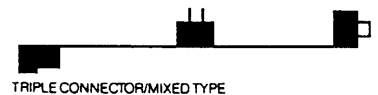
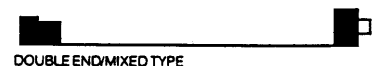
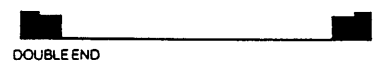
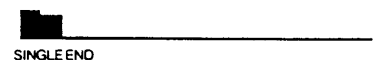



PRODUCT DESCRIPTION

The 636 Series Female Socket Connector is designed to mate with Ansley® PCB male headers. 636 Series Female Sockets can be terminated to all types of Ansley® flat cable by using hand, bench or semi-automated application tooling. This connector series meets the polarising specifications of MIL-C-83503, DIN 41651, BS 9525 F0023 and HE10.

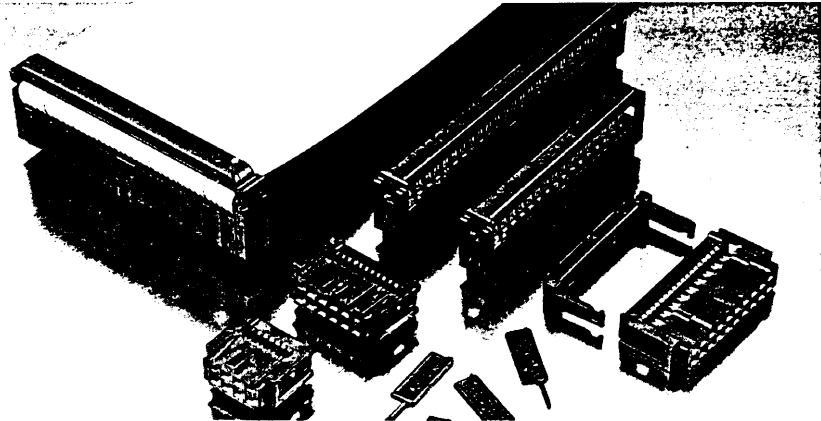

PRODUCT ADVANTAGES

- Broad range of connector sizes available - 6 through 64 contacts.
- Industry standard polarisation option to meet wide variety of specifications.
- Pre-latched top cover with built-in cable registration allows all Ansley® cables to be positively located before, during the after the crimping operation.
- Strain relief option protects cable-connector termination area and maintains integrity of mass termination over repeated operations.
- Closed entry connector design eliminates mismatching when connected to unshrouded male post headers.
- 0,3 mm material thickness provides maximum surface area of terminal-to-conductor for optimum electrical and long term performance.

TECHNICAL DATA

Insulation material	Glass reinforced thermoplastic
	Rated UL 94V-0
Colour	Black
Contact material	Copper Alloy 654
Contact Plating - Mating Zone	0,38 µM gold selective plating over 1.3 µM nickel
Contact Plating - Termination Zone	Tin/Lead over nickel
Current rating	1 Amp
Insulation resistance	> 1 x 10 Ohms
Dielectric strength	> 500 DC
Temperature rating	- 55°C to + 105°C

INSTALLATION TOOLS

Hand Tool	779-2100
with Die	779-2151
Bench Press or	779-3200
Bench Press (Pneumatic)	779-3500 XT
with Standard Platen	779-3134
and Base Plate	779-3151
Semi-Auto Single Feed	779-7100
Twin Feed	779-7200
Triple Feed	779-7300
Fully Automatic	779-9500

636 - 34 30 TH

Connector Series

No. of positions

- 00 - Dual slot polarisation
- 01 - Dual slot polarisation with strain relief
- 30 - Dual slot/central polarisation
- 41 - Dual slot/central polarisation w. strain relief
- 31 - Strain relief only

Optional plating
TH-Tin/Lead over Nickel

636 - 0000 - Coding Key (Qty. 5/Strip)

UL E60980

SP LR49314

For test report request publication
No. ETR005

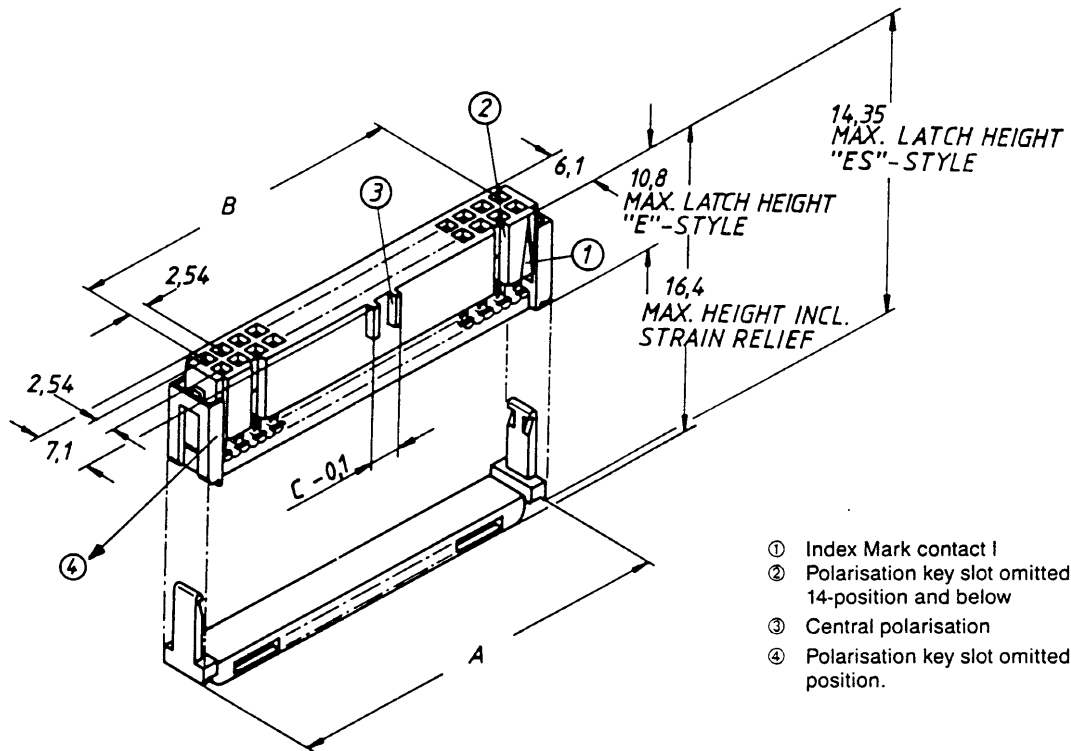

- ① Index Mark contact I
- ② Polarisation key slot omitted on 14-position and below
- ③ Central polarisation
- ④ Polarisation key slot omitted on 6 + 8 position.

For tin-lead plating option, add TH to end of Cat. No. (eg. 636-3430 TH)

Pull tab option for use with strain relief order cat. no. 622-1PT, (10 – 20), 622-1,5PT (24 – 34) or 622-2PT (36 – 64)

No. of Pos.	CATALOGUE NUMBERS				DIMENSIONS		
	Dual Slot Pol.	Dual Slot Pol. with strain relief	Dual Slot and central Pol.	Dual Slot and central Pol. with strain	A	B	C
6	636-0600	636-0601	636-0630	636-0641	12,12	5,08	1,9
8	636-0800	636-0801	636-0830	636-0841	14,66	7,62	1,9
10	636-1000	636-1001	636-1030	636-1041	17,20	10,16	3,2
12	636-1200	636-1201	636-1230	636-1241	19,74	12,70	3,8
14	636-1400	636-1401	636-1430	636-1441	22,28	15,24	3,8
16	636-1600	636-1601	636-1630	636-1641	24,82	17,78	3,8
20	636-2000	636-2001	636-2030	636-2041	29,90	22,86	3,8
24	636-2400	636-2401	636-2430	636-2441	34,98	27,94	3,8
26	636-2600	636-2601	636-2630	636-2641	37,52	30,48	3,8
30	636-3000	636-3001	636-3030	636-3041	42,60	35,56	3,8
34	636-3400	636-3401	636-3430	636-3441	47,68	40,64	3,8
36	636-3600	636-3601	636-3630	636-3641	50,22	43,18	3,8
40	636-4000	636-4001	636-4030	636-4041	55,30	48,26	3,8
44	636-4400	636-4401	636-4430	636-4441	60,38	53,34	3,8
50	636-5000	636-5001	636-5030	636-5041	68,00	60,96	3,8
52	636-5200	636-5201	636-5230	636-5241	70,54	63,50	3,8
56	636-5600	636-5601	636-5630	636-5641	75,62	68,58	3,8
60	636-6000	636-6001	636-6030	636-6041	80,70	73,66	3,8
64	636-6400	636-6401	636-6430	636-6441	85,78	78,74	3,8

PRODUCT DESCRIPTION

The 636 Series PCB mounted headers are designed to be mated with Ansley® female sockets. This range of headers meets industry standard polarisation specifications of MIL-C-83503, DIN 41651 and BS9525 F0023, HE10 and can be optioned with lock and ejector facility. PC board mounting of the header can be specified either in vertical or horizontal styles accommodating board thickness of between 1,6 to 3,2 mm.

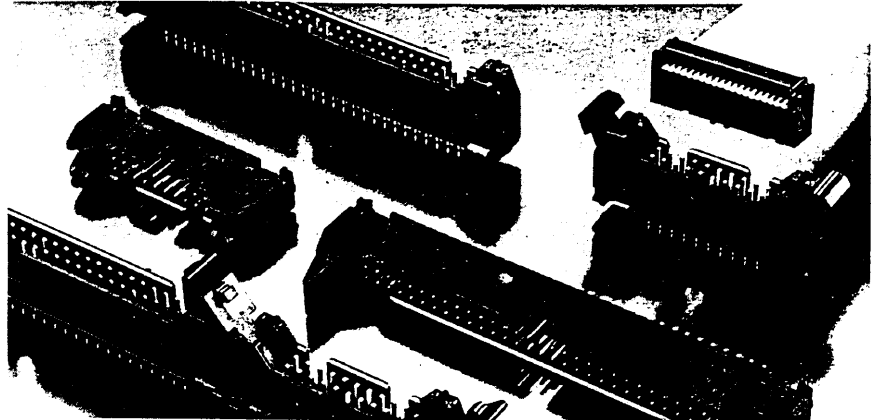

PRODUCT ADVANTAGES

- Broad range of connector sizes available – 6 through 64 contacts.
- Four wall design protects the male post contacts in the unmated position and alleviates pin damage during mating and unmating cycles.
- Short or long solder tail termination in vertical or horizontal mounting styles.
- Headers maintain continuous end stackability when specified with or without ejector/retainer option.
- Dual polarisation meets industry standards while maintaining full compatibility with Ansley® IDC female sockets.
- Integral moulded stand-offs for enhanced PCB solder and cleaning operations.

TECHNICAL DATA

<p>Insulation material</p> <p>Colour</p> <p>Contact material</p> <p>Contact plating</p> <p>Current rating</p> <p>Insulation resistance</p> <p>Dielectric strength</p> <p>Temperature rating</p>	<p>Glass reinforced thermoplastic rated UL 94V-0</p> <p>Black</p> <p>Copper Alloy</p> <p>0,38 µM gold selctive plating over 1.3 µM nickel</p> <p>1 Amp</p> <p>> 1 x 10⁹ Ohms</p> <p>> 500 V DC</p> <p>-55°C to + 105°C</p>
---	---

636 - 34 24 ES TH

Connector Series

No. of positions

- 04 - Right Angle 1,6 Thk PCB
- 14 - Right Angle 3,2 Thk PCB
- 24 - Straight 1,6 Thk PCB
- 34 - Straight 3,2 Thk PCB

ES - for female socket connectors with strain relief

E - for female socket connectors without strain relief

Optional plating

TH-Tin-Lead over Nickel

E60980

LR49314

For test report request publication No. ETR005

- ① Index mark contact 1
- ② Polarisation key slot omitted on 14 position and below
- ③ Centre key pol. dimension 2 for 6 + 8 position
- ④ Polarisation key slot omitted on 6 + 8 position
- ⑤ Recommended fixing screws 4 - 24 x 8 mm or 4 - 48 x 8 mm thread cutting screws
- ⑥ For polarising key order catalogue number 636-0056P (Qty. 10/Strip)

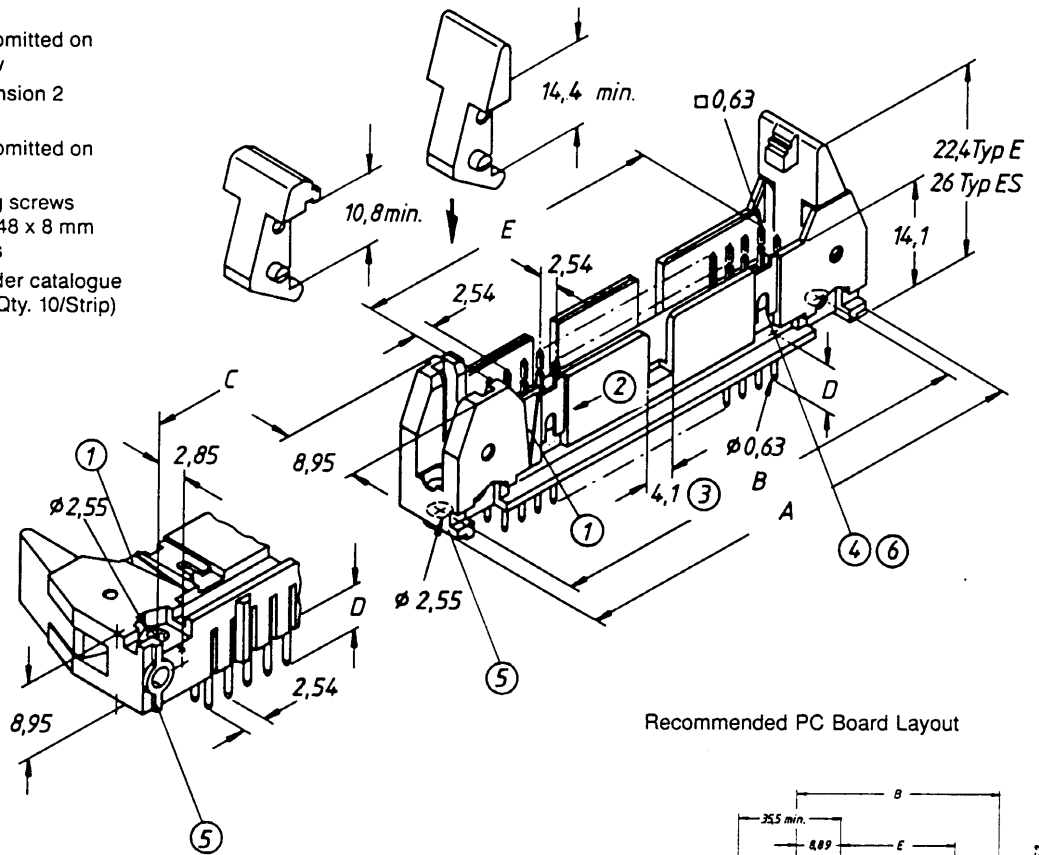

Recommended PC Board Layout

NOTE: Part numbers shown indicate headers without retainer/ejector latches.
 Add suffix "E" for latches to accommodate female socket connectors WITHOUT strain relief.
 Add suffix "ES" for latches to accommodate female connectors WITH strain relief.
 For tin-lead plating option, add TH to end of Cat.No. (EG 636-3424TH/636-3424ESTH)

No. of Pos.	CATALOGUE NUMBERS				DIMENSIONS			
	Straight Solder Tails for PCB Thickness		Right Angle Solder Tails for PCB Thickness		A	B	C	E
	1,6 mm Tail Length D = 2,9	3,2 mm Tail Length D = 4,5	1,6 mm Tail Length D = 2,9	3,2 mm Tail Length D = 4,5				
6	636-0624	636-0634	636-0604	636-0614	27,02	22,86	16,76	5,08
8	636-0824	636-0834	636-0804	636-0814	29,56	25,40	19,50	7,62
10	636-1024	636-1034	636-1004	636-1014	32,10	27,94	21,84	10,16
12	636-1224	636-1234	636-1204	636-1214	34,64	30,48	24,38	12,70
14	636-1424	636-1434	* 636-1404	636-1414	37,18	33,02	26,92	15,24
16	636-1624	636-1634	636-1604	636-1614	39,72	35,56	29,46	17,78
20	636-2024	636-2034	636-2004	636-2014	44,80	40,04	34,54	22,86
24	636-2424	636-2434	636-2404	636-2414	49,88	45,72	39,62	27,94
26	636-2624	636-2634	636-2604	636-2614	52,42	48,26	42,16	30,48
30	636-3024	636-3034	636-3004	636-3014	57,50	53,34	47,24	35,56
34	636-3424	636-3434	636-3404	636-3414	62,58	58,42	52,32	40,64
36	636-3624	636-3634	636-3604	636-3614	65,12	60,96	54,86	43,18
40	636-4024	636-4034	636-4004	636-4014	70,20	66,04	59,94	48,26
44	636-4424	636-4434	636-4404	636-4414	75,28	71,12	65,02	53,34
50	636-5024	636-5034	636-5004	636-5014	82,90	78,74	72,64	60,96
52	636-5224	636-5234	636-5204	636-5214	85,44	81,28	75,18	63,50
56	636-5624	636-5634	636-5604	636-5614	90,52	86,36	80,26	68,58
60	636-6024	636-6034	* 636-6004	636-6014	95,60	91,44	85,34	73,66
64	636-6424	636-6434	636-6404	636-6414	100,68	96,52	90,42	78,74

PRODUCT DESCRIPTION

ANSLEY® Card Edge Connectors are designed to provide a high performance flat-cable interface to double-sided printed circuit boards.

A variety of mounting options and strain relief provide application versatility.

In addition to snap in polarising keys, 20- and 34-position connectors with moulded-in polarisation for standard interfaces are available.

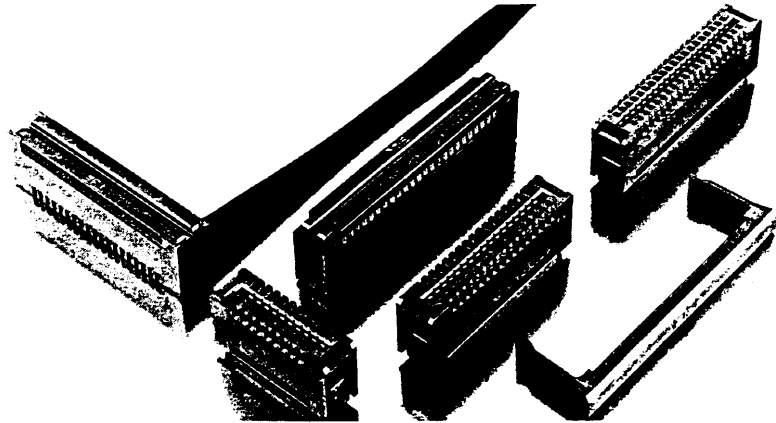

PRODUCT ADVANTAGES

- Pre-loaded contact reduces insertion forces and provides a controlled mating/unmating condition.
- Closed entry lead-in prevents connector damage during mating operation.
- Broad range of connector sizes available, to through 60 contacts.
- Prelatched top cover with built in cable registration allows Ansley® flat cables to be positively located before, during and after crimping operation.
- Snap in polarising keys lock securely into the connector body.
- Chamfered, connector lead-in design enhances alignment and reduces insertion force when plugging to PCB.

TECHNICAL DATA

Insulation material	Glass reinforced thermoplastic rated UL 94V-0
Colour	Black
Contact material	Copper Alloy 654
Contact surface	0,38 µM gold selective plating over 1.3µM nickel
Current rating	1 Amp
Insulation resistance	> 1 x 10 ⁹ Ohms
Dielectric strength	> 500 V DC
Temperature rating	-55°C to + 105°C

INSTALLATION TOOLS

Hand Tool with Die	779-2100
Bench Press or Bench Press (pneumatic) with Standard Platen and Base Plate	779-2164
Semi-Auto Single Head or Twin Head	779-3200
or Triple Head	779-3500 XT
Fully Automatic	779-3130
	779-3164
	779-7100
	779-7200
	779-7300
	779-9500

636 - 10 05

Connector Series

No. of positions

- 05 - with full mounting ears
- 15 - without mounting ears
- 25 - with half mounting ears
- 35 - optional strain relief

636-0005 - optional polarisation key

E60980

LR49571

For test report request publication No. TR 007

636-7X15GP20TB 20- or 34-position Card Edge Connector with moulded-in polarisation between contacts 3 and 5

Card Edge Connectors
10 – 60 Position,
20 and 34 Position with moulded-in
polarisation and accessories

Card Edge Connectors with
moulded-in polarisation
between contacts 3 and 5
636-2015G3P02 and
636-3415G3P02
(disk drive applications)

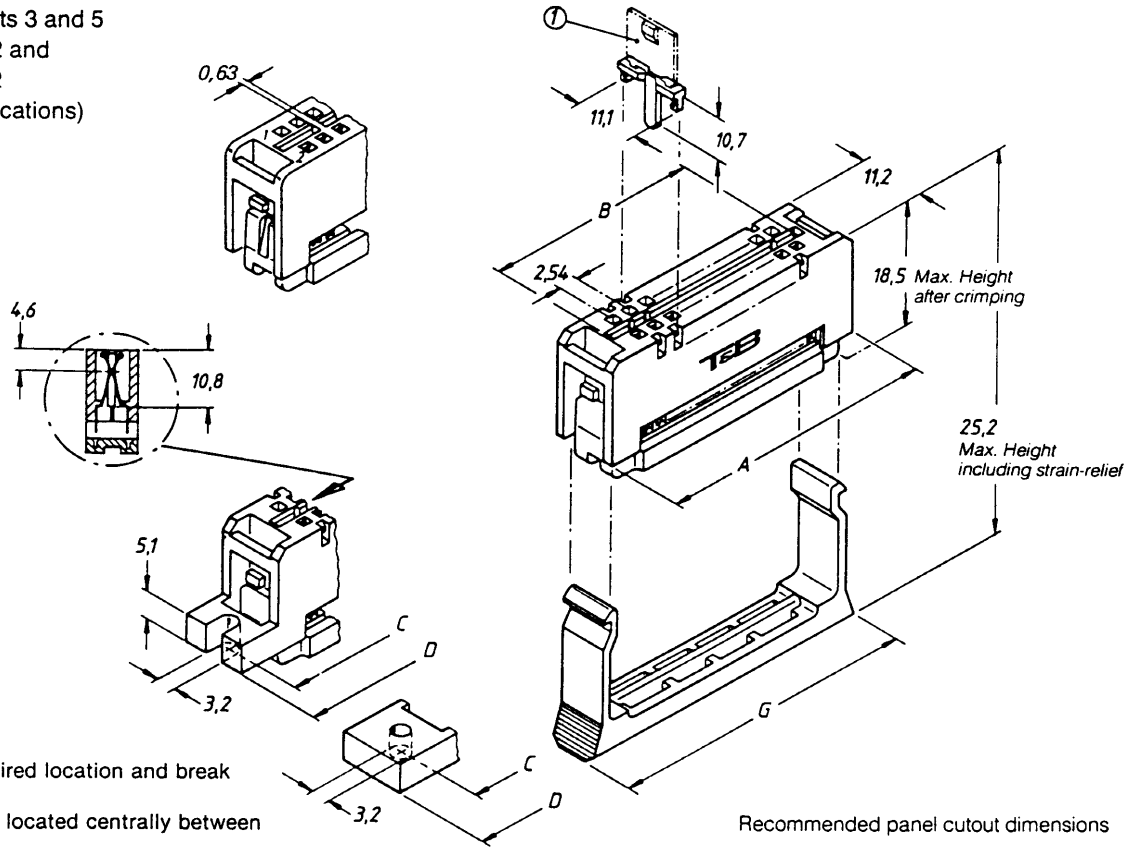

- ① Insert into desired location and break off tab
- ② Polarising slot located centrally between contact pads

Recommended panel cutout dimensions

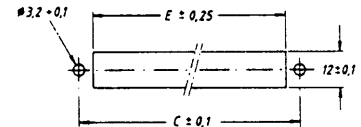

Recommended PC. Board dimensions

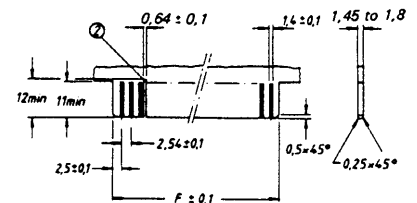

Strain relief

for No. of Pos.	Cat. No.	Dimensions in mm G
10	636-1035	28,19
16	636-1635	35,81
20	636-2035	40,89
26	636-2635	48,51
30	636-3035	53,59
34	636-3435	58,67
40	636-4035	66,29
50	636-5035	78,99
60	636-6035	91,69

No. of Pos.	Cat. No.	Type of Body	Dimensions in mm					
			A	B	C	D	E	F
10	636-1015		24,4	15,4			25,1	15,1
16	636-1615		32,0	23,0			32,7	22,7
20	636-2015		37,1	28,1			37,8	27,8
26	636-2615	without mounting ears	44,7	35,7			45,4	35,4
30	636-3015		49,8	40,8			50,5	40,5
34	636-3415		54,8	45,9			55,6	45,6
40	636-4015		62,5	53,5			63,2	53,2
50	636-5015		75,2	66,2			75,9	65,9
60	636-6015		87,9	78,9			88,6	78,6
10	636-1025		24,4	15,4	33,0	38,1	25,1	15,1
16	636-1625		32,0	23,0	40,6	45,7	32,7	22,7
20	636-2025		37,1	28,1	45,7	50,8	37,8	27,8
26	636-2625	with half mounting ears	44,7	35,7	53,3	58,4	45,4	35,4
30	636-3025		49,8	40,8	58,4	63,5	50,5	40,5
34	636-3425		54,8	45,9	63,5	68,6	55,6	45,6
40	636-4025		62,5	53,5	71,1	76,2	63,2	53,2
50	636-5025		75,2	66,2	83,8	88,9	75,9	65,9
60	636-6025		87,9	78,9	96,5	101,6	88,6	78,6
10	636-1005		24,4	15,4	35,6	47,3	25,1	15,1
16	636-1605		32,0	23,0	43,2	54,9	32,7	22,7
20	636-2005		37,1	28,1	48,3	60,0	37,8	27,8
26	636-2605	with full mounting ears	44,7	35,7	55,9	67,6	45,4	35,4
30	636-3005		49,8	40,8	61,0	72,6	50,5	40,5
34	636-3405		54,8	45,9	66,0	77,7	55,6	45,6
40	636-4005		62,5	53,5	73,7	85,4	63,2	53,2
50	636-5005		75,2	66,2	86,4	98,1	75,9	65,9
60	636-6005		87,9	78,9	99,1	110,8	88,6	78,6



PRODUCT DESCRIPTION

ANSLEY® 2-Row PCB Solder Transition Connectors allow fast and reliable solder termination of flat cable to printed circuit boards. They are ideal when no disconnect facility is required or when the possibility of substitution for 2.54 mm x 2.54 mm headers shall be preserved.

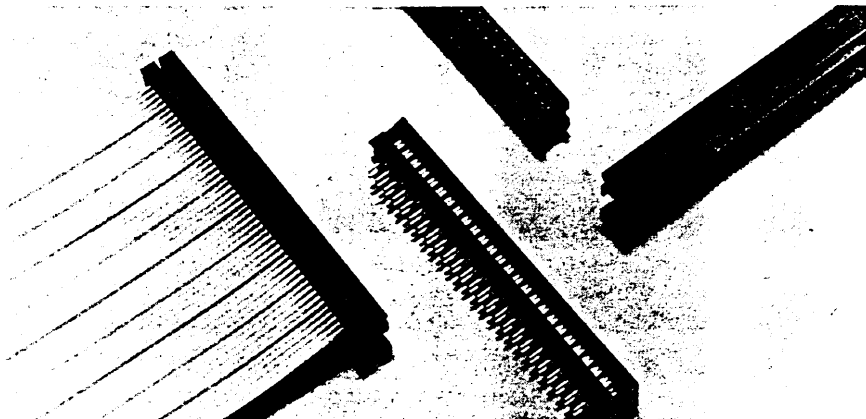

PRODUCT ADVANTAGES

- Broad range of 16 different positions provides for application versatility.
- Compact size allows maximum packaging density.
- 2.54 mm x 2.54 mm standard grid allows use of either PCB solder transition or male header connector.
- Flat cable can be crimped before or after the connector has been soldered to the board to suit the manufacturing process.
- 2 solder tail lengths for 1,6 mm through 3,2 mm board thickness.
- Optional stainless steel strain relief, provides mechanical stress protection in a low profile package.

TECHNICAL DATA

Insulation material	Glass reinforced thermoplastic rated UL 94V-0
Colour	Black
Contact material	Copper Alloy 654
Contact surface	Tin over nickel
Current rating	1 Amp
Insulation resistance	> 1 x 10 ⁹ Ohms
Dielectric strength	> 500 V DC
Temperature rating	-55°C to + 105°C

INSTALLATION TOOLS

Cable installation before soldering

Hand Tool	779-2100
with Die	779-2175
Bench Press or	779-3200
Bench Press (pneumatic)	779-3500 XT
with Standard Platen and Base Plate	779-3130
	779-3153
Semi-Auto Single Head or Twin Head	779-7100
	779-7200
or Triple Head	779-7300
Fully Automatic	779-9500

Cable installation after soldering

Bench press (see above)	
with modified Platen	779-3133
and Base Plate	779-3154

636 - 06 53

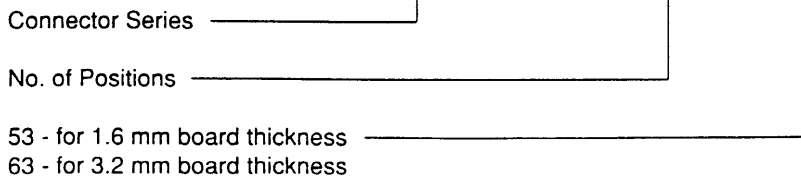

UL E60980

SP LR49571

622-XX33 optional strain relief

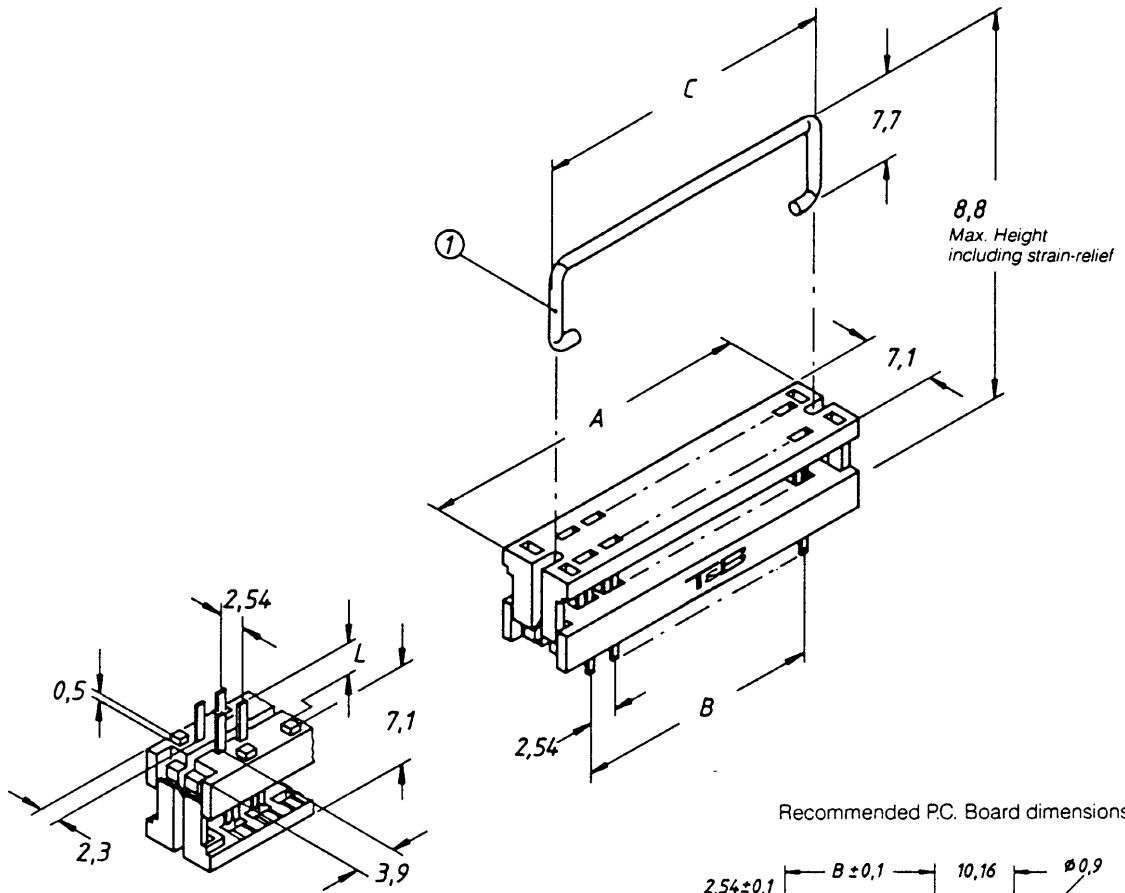

① Material: Stainless steel, Type 302 \varnothing 0.8 mm

Recommended PC. Board dimensions

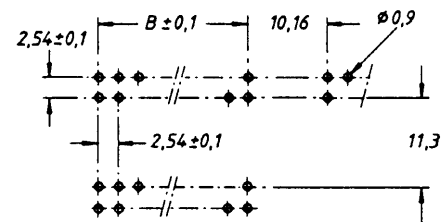

Optional Strain Relief

No. of Pos.	Cat. No. for PCB thickness		Dimensions in mm	
	1.6 mm Tail length L = 2.5	3.2mm Tail length L = 4.0	A	B
6	636-0653	636-0663	13.0	5.08
8	636-0853	636-0863	15.6	7.62
10	636-1053	636-1063	18.1	10.16
14	636-1453	636-1463	23.2	15.24
16	636-1653	636-1663	25.7	17.78
20	636-2053	636-2063	30.8	22.86
24	636-2453	636-2463	35.9	27.94
26	636-2653	636-2663	38.4	30.48
30	636-3053	636-3063	43.5	35.56
34	636-3453	636-3463	48.6	40.64
36	636-3653	636-3663	51.1	43.18
40	636-4053	636-4063	56.2	48.26
44	636-4453	636-4463	61.3	53.34
50	636-5053	636-5063	68.9	60.96
60	636-6053	636-6063	81.6	73.66
64	636-6453	636-6463	86.7	78.74

For No. of Pos.	Cat. No.	Dimensions in mm C
6	622-0633	11.5
8	622-0833	14.1
10	622-1033	16.6
14	622-1433	21.7
16	622-1633	24.2
20	622-2033	29.3
24	622-2433	34.4
26	622-2633	36.9
30	622-3033	42.0
34	622-3433	47.1
36	622-3633	49.6
40	622-4033	54.7
44	622-4433	59.8
50	622-5033	67.4
60	622-6033	80.1
64	622-6433	85.2

PRODUCT DESCRIPTION

ANSLEY® flat cable is designed and manufactured by Thomas & Betts to be mass terminated to all ANSLEY® IDC connector families. Primarily designed as a signal level transmission cable, this highly flexible symmetrical cable is extruded so that a precise 1.27 pitch can be maintained from conductor to conductor. Standard P.V.C. flat cable is available in stranded or solid conductor styles in either 26 or 28 AWG, ranging from 4 to 64 conductor widths.

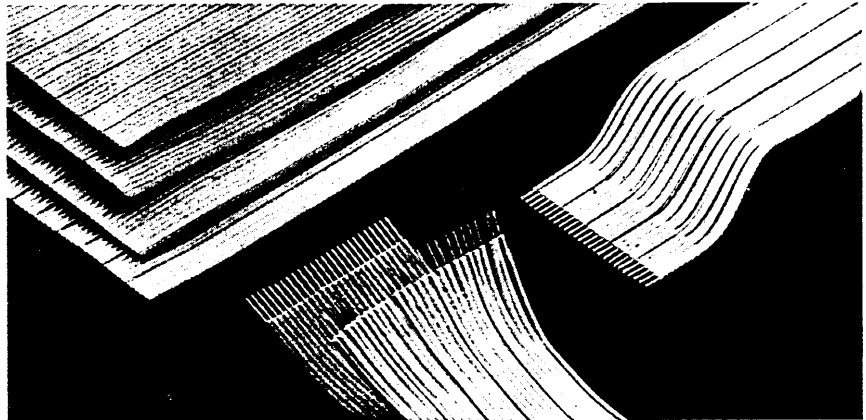

PRODUCT ADVANTAGES

- Extruded cable ensures narrow pitch tolerances.
- Profiles on both sides ensure positive alignment of the cable in the connector; connectors can be terminated to flat cable in up or down configurations.
- Extruded insulation allows separation of individual conductors without damage to insulation.
- Blue stripe on no. 1 conductor assures positive polarisation. Alternating red and blue stripes on every 5th conductor make identification of individual conductors easy.
- Highly flexible cable can be easily folded or bent.
- All standard cable types UL-listed.

TECHNICAL DATA

Cat. No.	171	173	178	179
Conductor: E-Cu tin-plated	AWG 28/7	AWG 28	AWG 26	AWG 26/7
Cross-section	Stranded	Solid	Solid	Stranded
Insulation	PVC	PVC	PVC	PVC
Temperature Rating (+ °C)	105	105	105	105
Voltage Rating (Vrms)	300	300	300	300
Max. Continuous Current (A)	1	1	3	3
Characteristic Impedance (ohms)	100	105	103	93
Capacitance (pF/m)	46	44.3	44.3	49.5
Inductance (µH/m)	0.46	0.49	0.46	0.43
Velocity of Propagation (ns/m)	4.53	4.53	4.53	4.43
Insulation Resistance (ohms)	10 ¹⁰	10 ¹⁰	10 ¹⁰	10 ¹⁰
Typical Crosstalk Characteristics	Rise time (ns)			
with	Near end %			
Cable length 10 ft. (3.048m)	Far end %			
UL Style No.				

INSTALLATION TOOLS

Cutting

- Hand Cable Cutter 779-5030
- Die for all ANSLEY Bench Press Cable Cutters 779-3181
- with Platen 779-3132

Separating

- Bench Cable Separator 779-5010G
- Hand Tool Cable Separator 779-5020G

Stripping

- Hand Stripping Tool 779-5040

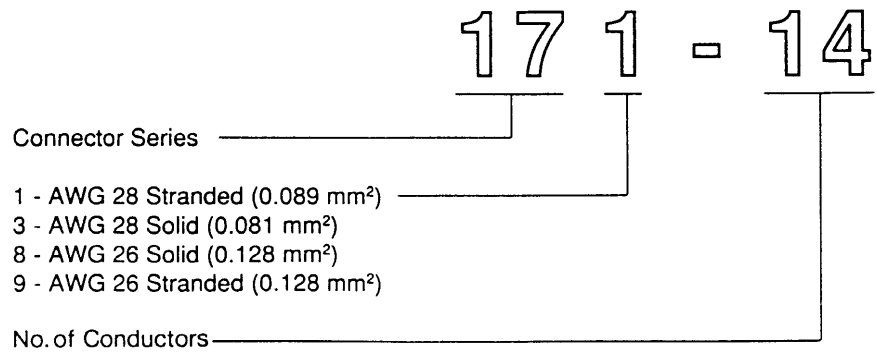

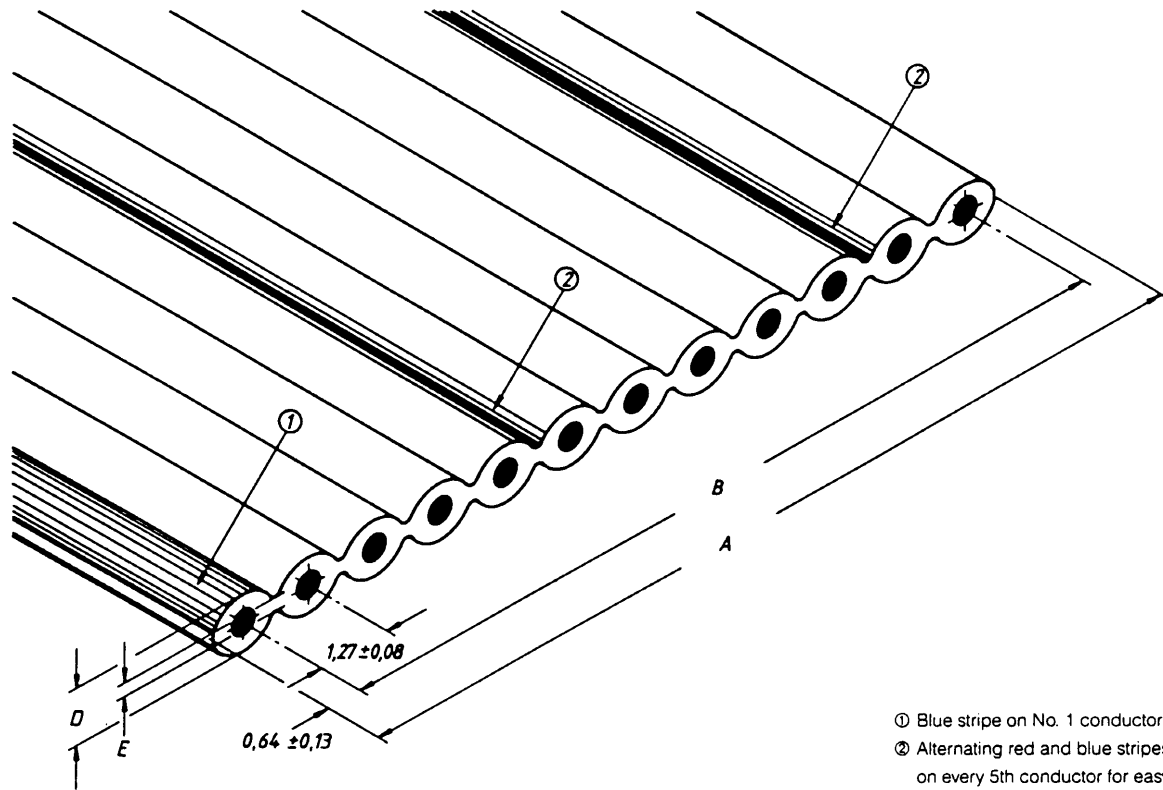

- ① Blue stripe on No. 1 conductor
- ② Alternating red and blue stripes on every 5th conductor for easy identification

Standard cable length per reel is 100 ft (30.48 m).
 Cable length 300 ft (91.44 m) can be ordered by adding -300 to catalog number (e. g. 171-4-399)
 Cable 171 is available in sections of 100 m; it can be ordered by adding G 100 to the catalog number (e. g. 171-4 G 100)

No. of Pos.	Cat. No.				Dimensions in mm			
	AWG 28 Stranded	AWG 28 Solid	AWG 26 Solid	AWG 26 Stranded	A	B	Tolerance ±	E ± 0.06
4	171-4				5.8	3.81	0.18	0.24
6	171-6				7.6	6.35	0.18	0.24
8	171-8				10.2	8.89	0.18	0.24
9	171-9	173-9			11.4	10.16	0.18	0.24
10	171-10	173-10	178-10	179-10	12.7	11.43	0.18	0.24
14	171-14	173-14	178-14	179-14	17.8	16.51	0.18	0.24
15	171-15	173-15			19.1	17.78	0.25	0.24
16	171-16	173-16	178-16	179-16	20.3	19.05	0.25	0.24
18	171-18				22.9	21.59	0.25	0.24
20	171-20	173-20	178-20	179-20	25.4	24.13	0.25	0.24
22	171-22				28.0	26.67	0.25	0.24
24	171-24	173-24	178-24	179-24	30.5	29.21	0.25	0.24
25	171-25	173-25			31.8	30.48	0.25	0.24
26	171-26	173-26	178-26	179-26	33.0	31.75	0.25	0.24
30	171-30				38.1	36.83	0.25	0.24
34	171-34	173-34	178-34	179-34	43.2	41.91	0.25	0.24
36	171-36		178-36	179-36	45.7	44.45	0.25	0.24
37	171-37	173-37			47.0	45.72	0.25	0.24
40	171-40	173-40	178-40	179-40	50.8	49.53	0.38	0.24
44	171-44	173-44	178-44	179-44	55.9	54.61	0.38	0.24
50	171-50	173-50	178-50	179-50	63.5	62.23	0.38	0.24
56	171-56	173-56			71.1	69.85	0.38	0.24
60	171-60	173-60	178-60	179-60	76.2	74.93	0.38	0.24
64	171-64	173-64	178-64	179-64	81.3	80.01	0.38	0.24

0.86/0.97 0.86/0.97 0.96/1.04 0.96/1.04 D min./max. Dimensions in mm

636 Bandoliered Connectors may be specified with four different orientation options. These reel winding options, enable connector-up, connector-down, key-in or key-out assemblies to be produced, depending on desired harness style, and pin number 1 location.

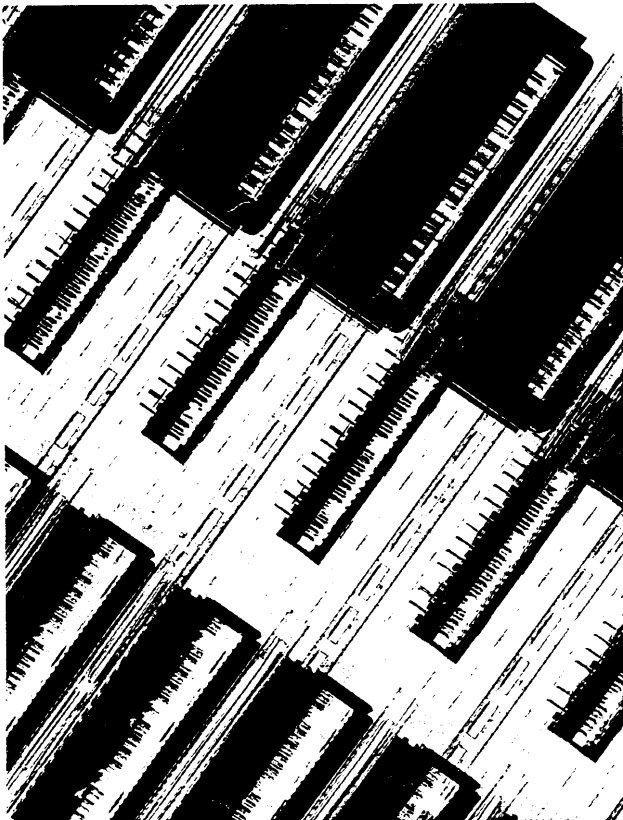

Female Socket, Card Edge and PCB Solder Transition Connectors may be bandolier packaged for Assembly System utilisation.

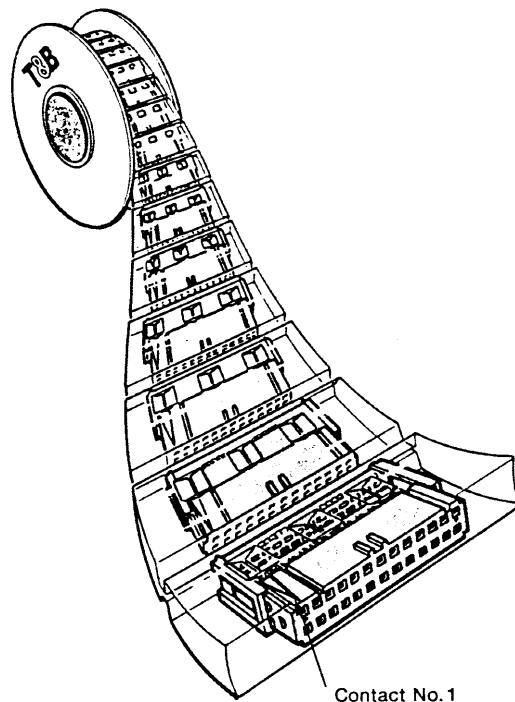

Typical product shown assembled in bandolier cover up/pin 1 front orientation

636 - 5030 B 1 - 5

Product Family Code

Standard Product Code
(Excluding Strain Relief Option)

Bandolier Packaged

1. Cover up pin 1 front
2. Cover down pin 1 front
3. Cover up pin 1 rear
4. Cover down pin 1 rear

Number of connectors per reel
5 - 500 sockets
3 - 300 card edge
5 - 500 solder transition

For alternative plating options in bandolier packaging, consult Thomas & Betts for ordering code.

Cat. No.	Page	Cat. No.	Page	Cat. No.	Page	Cat. No.	Page
171-XX	16	636-XX01	8-9	636-XX31	8-9	779-3134	8
173-XX	16	636-XX04E/ES	10	636-XX43E/ES	10	779-3151	8
178-XX	16	636-XX05	12	636-XX35	12	779-3164	12
178-XX	16	636-XX14E/ES	10	636-XX41	8-9	779-3200	8
179-XX	16	636-XX15	12	636-XX53	14	779-3500XT	8, 12
622-XX33	14	636-2015G3P02	12	636-XX63	14	779-7100	8, 12
636-0000	8-9	636-3415G3P02	12	779-2100	8, 12	779-7200	8, 12
636-0005	12	636-XX24E/ES	10	779-2151	8	779-7300	8, 12, 14
636-XX30BX-5	18	636-XX25	12	779-2164	12	779-9500	8, 12, 14
636-XX00	8-9	636-XX30	8-9	779-3130	12		

IMPORTANT: Thomas & Betts shall have no liability for any loss, costs or damages incurred by the user in the event of misuse of this product or failure to follow all instructions. This exclusion of liability is in addition to all other limitations and exclusions of liability contained in Thomas & Betts Standard Warranty statement.

STANDARD WARRANTY: Thomas & Betts manufactures its goods and tools in a manner to be free of defects. Should any defect occur and be promptly notified within 90 days (in the case of other goods) from the date of delivery by Thomas & Betts, it will, at its option, either exchange or repair the tools or other goods or refund the purchase price.

LIMITATIONS AND EXCLUSIONS: This warranty is in lieu of all other representations and expressed and implied warranties and conditions statutory or otherwise (including the implied warranties of merchantability and fitness for purpose) and under no circumstances shall Thomas & Betts be liable for any incidental or consequential damages or loss. This shall not, however, apply to death or personal injury resulting from the negligence of Thomas & Betts.

Copyright © 1990 Thomas & Betts Design Team
 All rights reserved.
 Data and Specifications subject to change without notice.