

Si-PIN-Fotodiode mit Tageslichtsperrfilter; in SMT und als Reverse Gullwing Silicon PIN Photodiode with Daylight Filter; in SMT and as Reverse Gullwing

BPW 34 FA, BPW 34 FAS, BPW 34 FAS (E9087)

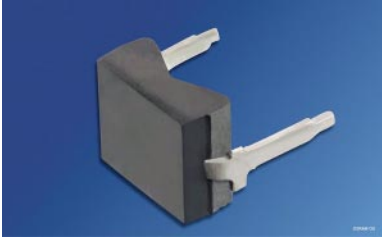

BPW 34 FA

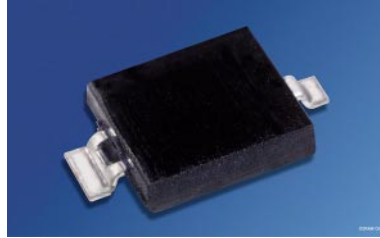

BPW 34 FAS

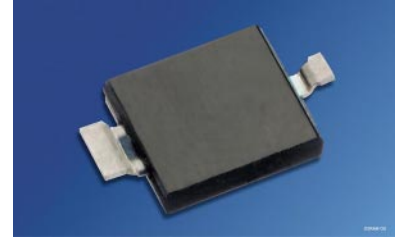

BPW 34 FAS (E9087)

Wesentliche Merkmale

- Speziell geeignet für den Wellenlängenbereich von 830 nm bis 880 nm
- Kurze Schaltzeit (typ. 20 ns)
- DIL-Plastikbauform mit hoher Packungsdichte
- BPW 34 FAS/(E9087): geeignet für Vapor-Phase Lötten und IR-Reflow Lötten

Anwendungen

- IR-Fernsteuerung von Fernseh- und Rundfunkgeräten, Videorecordern, Gerätefernsteuerung
- Lichtschranken für Gleich- und Wechsellichtbetrieb

Features

- Especially suitable for the wavelength range of 830 nm to 880 nm
- Short switching time (typ. 20 ns)
- DIL plastic package with high packing density
- BPW 34 FAS/(E9087): Suitable for vapor-phase and IR-reflow soldering

Applications

- IR-remote control of hi-fi and TV sets, video tape recorders, remote controls of various equipment
- Photointerrupters

Typ Type	Bestellnummer Ordering Code
BPW 34 FA	Q62702-P1129
BPW 34 FAS	Q62702-P463
BPW 34 FAS (E9087)	Q62702-P1829

Grenzwerte

Maximum Ratings

Bezeichnung Parameter	Symbol Symbol	Wert Value	Einheit Unit
Betriebs- und Lagertemperatur Operating and storage temperature range	$T_{op}; T_{stg}$	- 40 ... + 100	°C
Sperrspannung Reverse voltage	V_R	32	V
Verlustleistung, $T_A = 25\text{ °C}$ Total power dissipation	P_{tot}	150	mW

Kennwerte ($T_A = 25\text{ °C}$, $\lambda = 870\text{ nm}$)

Characteristics

Bezeichnung Parameter	Symbol Symbol	Wert Value	Einheit Unit
Fotostrom Photocurrent $V_R = 5\text{ V}$, $E_e = 1\text{ mW/cm}^2$	I_p	50 (≥ 40)	μA
Wellenlänge der max. Fotoempfindlichkeit Wavelength of max. sensitivity	$\lambda_{S_{max}}$	880	nm
Spektraler Bereich der Fotoempfindlichkeit $S = 10\%$ von S_{max} Spectral range of sensitivity $S = 10\%$ of S_{max}	λ	730 ... 1100	nm
Bestrahlungsempfindliche Fläche Radiant sensitive area	A	7.00	mm^2
Abmessung der bestrahlungsempfindlichen Fläche Dimensions of radiant sensitive area	$L \times B$ $L \times W$	2.65×2.65	$\text{mm} \times \text{mm}$
Halbwinkel Half angle	φ	± 60	Grad deg.
Dunkelstrom, $V_R = 10\text{ V}$ Dark current	I_R	2 (≤ 30)	nA
Spektrale Fotoempfindlichkeit Spectral sensitivity	S_λ	0.65	A/W
Quantenausbeute Quantum yield	η	0.93	<u>Electrons</u> Photon
Leerlaufspannung, $E_e = 0.5\text{ mW/cm}^2$ Open-circuit voltage	V_O	320 (≥ 250)	mV

BPW 34 FA, BPW 34 FAS, BPW 34 FAS (E9087)

Kennwerte ($T_A = 25\text{ °C}$, $\lambda = 870\text{ nm}$)

Characteristics (cont'd)

Bezeichnung Parameter	Symbol Symbol	Wert Value	Einheit Unit
Kurzschlußstrom, $E_e = 0.5\text{ mW/cm}^2$ Short-circuit current	I_{SC}	23	μA
Anstiegs- und Abfallzeit des Fotostromes Rise and fall time of the photocurrent $R_L = 50\ \Omega$; $V_R = 5\text{ V}$; $\lambda = 850\text{ nm}$; $I_p = 800\ \mu\text{A}$	t_r, t_f	20	ns
Durchlaßspannung, $I_F = 100\text{ mA}$, $E = 0$ Forward voltage	V_F	1.3	V
Kapazität, $V_R = 0\text{ V}$, $f = 1\text{ MHz}$, $E = 0$ Capacitance	C_0	72	pF
Temperaturkoeffizient von V_O Temperature coefficient of V_O	TC_V	- 2.6	mV/K
Temperaturkoeffizient von I_{SC} Temperature coefficient of I_{SC}	TC_I	0.03	%/K
Rauschäquivalente Strahlungsleistung Noise equivalent power $V_R = 10\text{ V}$	NEP	3.9×10^{-14}	$\frac{\text{W}}{\sqrt{\text{Hz}}}$
Nachweisgrenze, $V_R = 10\text{ V}$, Detection limit	D^*	6.8×10^{12}	$\frac{\text{cm} \times \sqrt{\text{Hz}}}{\text{W}}$

Relative Spectral Sensitivity

$S_{rel} = f(\lambda)$

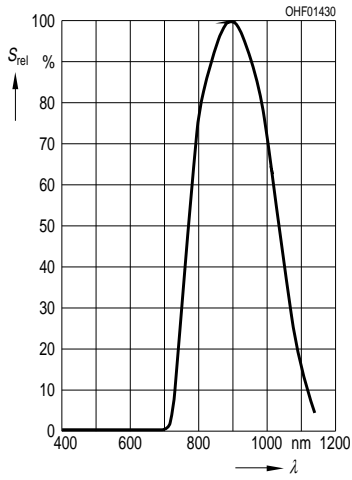

**Photocurrent $I_P = f(E_e)$, $V_R = 5 V$
Open-Circuit Voltage $V_O = f(E_e)$**

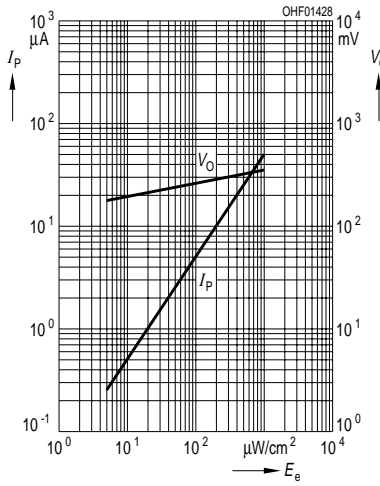

Total Power Dissipation

$P_{tot} = f(T_A)$

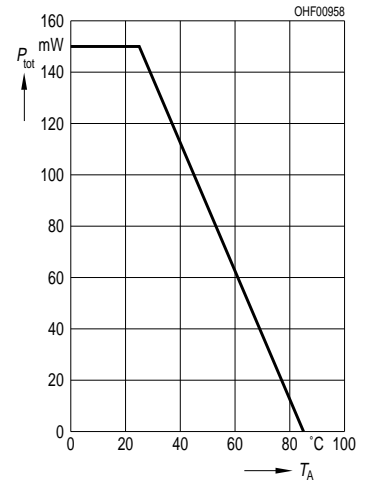

Dark Current

$I_R = f(V_R), E = 0$

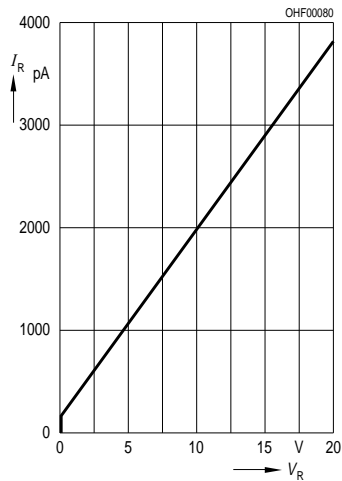

Capacitance

$C = f(V_R), f = 1 MHz, E = 0$

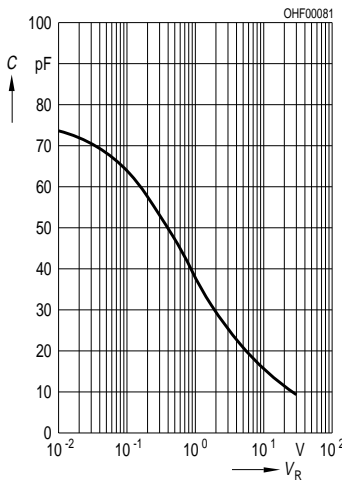

Dark Current

$I_R = f(T_A), V_R = 10 V, E = 0$

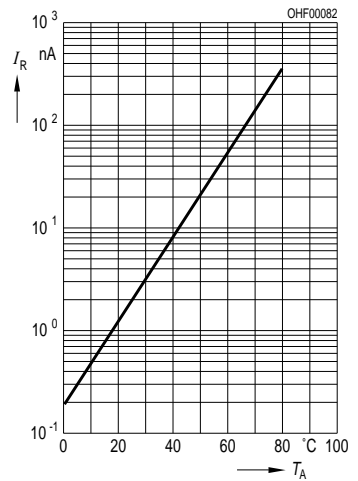

Directional Characteristics

$S_{rel} = f(\phi)$

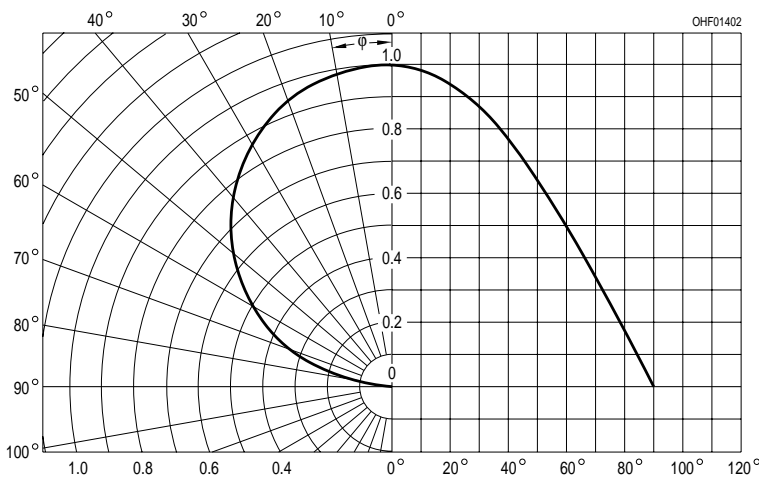

Maßzeichnung
Package Outlines

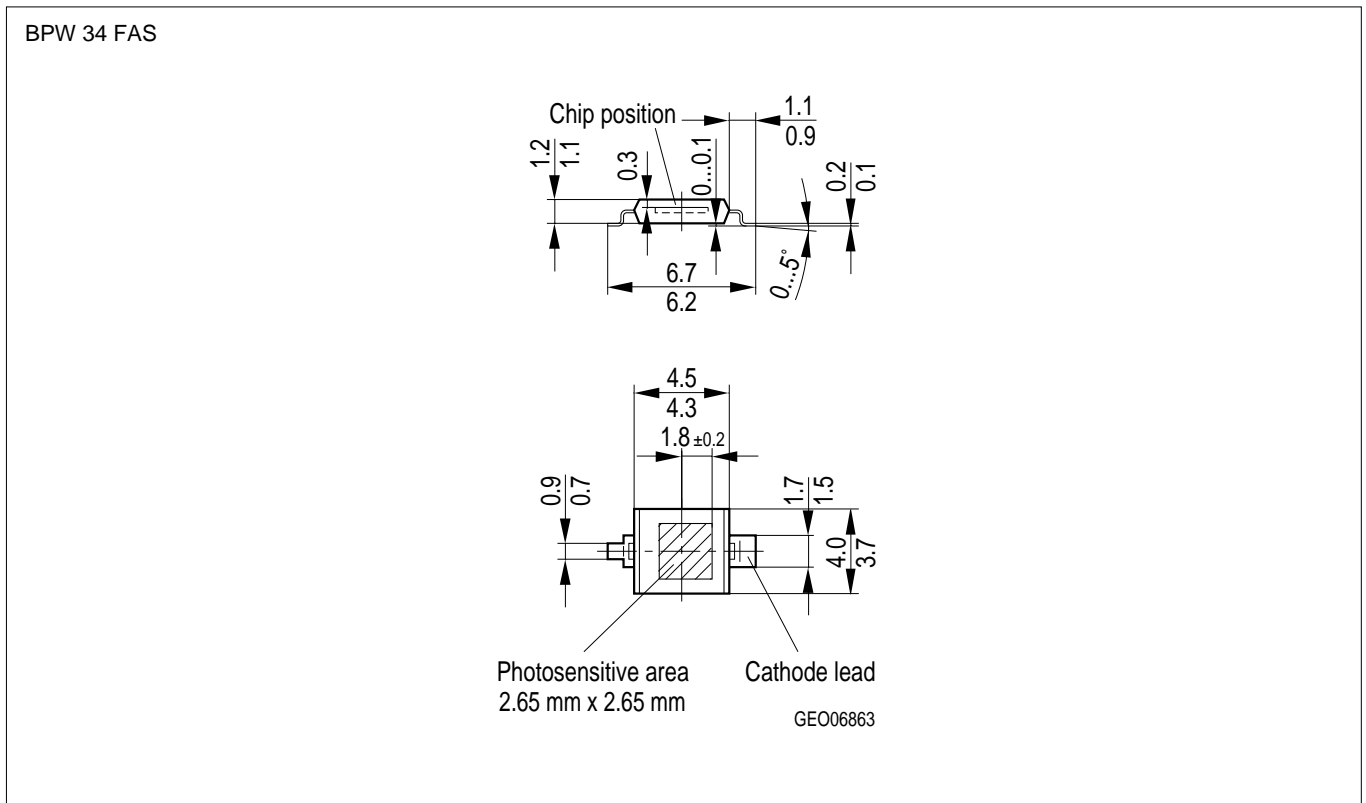
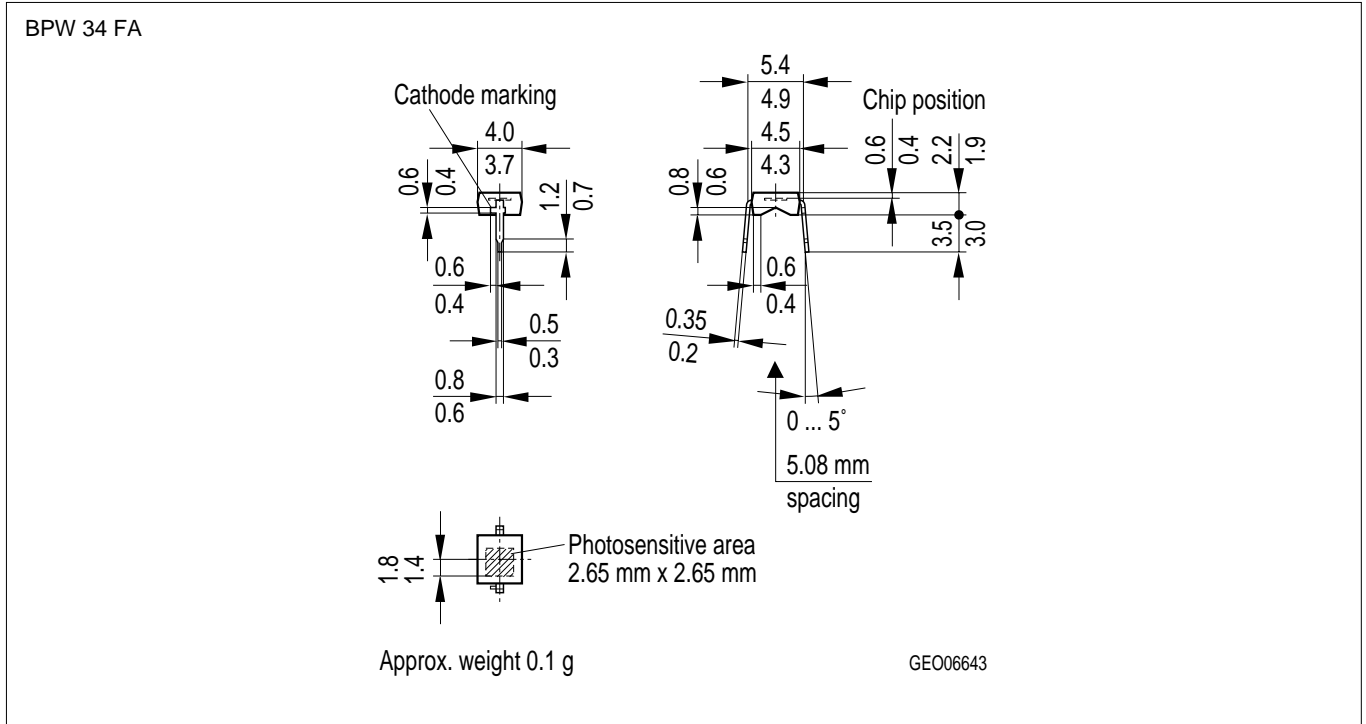

Maße in mm, wenn nicht anders angegeben / Dimensions in mm, unless otherwise specified.

BPW 34 FA, BPW 34 FAS, BPW 34 FAS (E9087)

BPW 34 FAS (E9087)

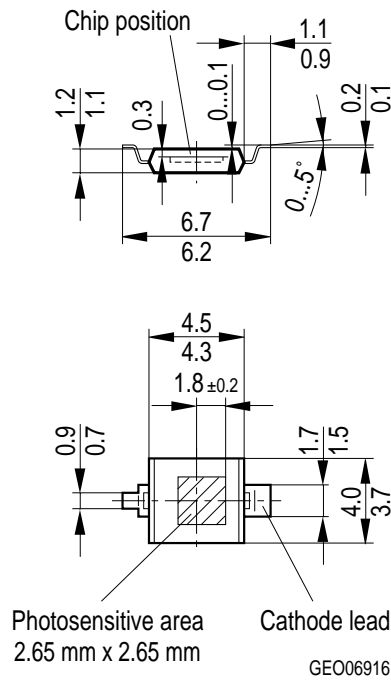

Maße in mm, wenn nicht anders angegeben / Dimensions in mm, unless otherwise specified.