

## 2 Form A Solid State Relay

### Features

- Current Limit Protection
- Isolation Test Voltage 5300 V<sub>RMS</sub>
- Typical R<sub>ON</sub> 10 Ω
- Load Voltage 200 V
- Load Current 140 mA
- High Surge Capability
- Clean Bounce Free Switching
- Low Power Consumption
- High Reliability Monolithic output die
- SMD Lead Available on Tape and Reel
- Lead-free component
- Component in accordance to RoHS 2002/95/EC and WEEE 2002/96/EC

### Agency Approvals

- UL1577, File No. E52744 System Code H or J, Double Protection
- CSA - Certification 093751
- DIN EN 60747-5-2 (VDE0884)  
DIN EN 60747-5-5 pending

### Applications

General Telecom Switching

- On/off Hook Control
- Ring Delay
- Dial Pulse
- Ground Start
- Ground Fault Protection

Instrumentation

Industrial Controls

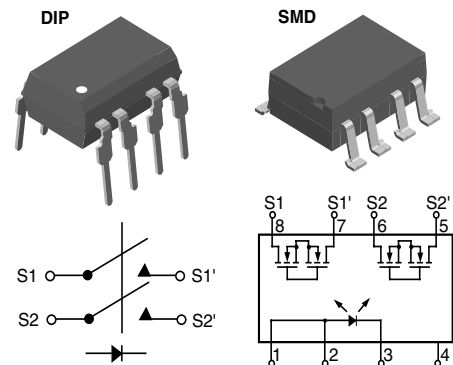

1179033



### Description

The LH1513 relays are DPST normally open switches (2 Form A) that can replace electromechanical relays in many applications. The relays are constructed using a GaAlAs LED for actuation control and an integrated monolithic die for the switch output. The die, fabricated in a high-voltage dielectrically isolated technology, is comprised of a photodiode array, switch control circuitry, and DMOS switches. In addition, these relays employ current-limiting circuitry, enabling them to pass FCC 68.302 and other regulatory voltage surge requirements when overvoltage protection is provided.

### Order Information

Part	Remarks
LH1513AAC	Tubes, SMD-8
LH1513AACTR	Tape and Reel, SMD-8
LH1513AB	Tubes, DIP-8

### Absolute Maximum Ratings, $T_{amb} = 25\text{ }^{\circ}\text{C}$

Stresses in excess of the absolute Maximum Ratings can cause permanent damage to the device. Functional operation of the device is not implied at these or any other conditions in excess of those given in the operational sections of this document. Exposure to absolute Maximum Ratings for extended periods of time can adversely affect reliability.

### SSR

Parameter	Test condition	Symbol	Value	Unit
LED continuous forward current		$I_F$	50	mA
LED reverse voltage	$I_R \leq 10\text{ }\mu\text{A}$	$V_R$	8.0	V
DC or peak AC load voltage	$I_L \leq 50\text{ }\mu\text{A}$	$V_L$	200	V
Continuous DC load current, one pole operating		$I_L$	200	mA
Continuous DC load current, two poles operating		$I_L$	140	mA
Peak load current (single shot)	$t = 100\text{ ms}$	$I_P$	1)	
Ambient temperature range		$T_{amb}$	- 40 to + 85	$^{\circ}\text{C}$
Storage temperature range		$T_{stg}$	- 40 to + 150	$^{\circ}\text{C}$
Pin soldering temperature	$t = 10\text{ s max}$	$T_{sld}$	260	$^{\circ}\text{C}$
Input/output isolation voltage		$V_{ISO}$	5300	$V_{RMS}$
Pole-to-pole isolation voltage (S1 to S2)			500	V
Output power dissipation (continuous)		$P_{diss}$	600	mW

1) Refer to Current Limit Performance Application Note for a discussion on relay operation during transient currents.

### Electrical Characteristics, $T_{amb} = 25\text{ }^{\circ}\text{C}$

Minimum and maximum values are testing requirements. Typical values are characteristics of the device and are the result of engineering evaluations. Typical values are for information only and are not part of the testing requirements.

### Input

Parameter	Test condition	Symbol	Min	Typ.	Max	Unit
LED forward current, switch turn-on	$I_L = 100\text{ mA}$ , $t = 10\text{ ms}$	$I_{Fon}$		2.0	3.0	mA
LED forward current, switch turn-off	$V_L = \pm 150\text{ V}$	$I_{Foff}$	0.2	0.8		mA
LED forward voltage	$I_F = 10\text{ mA}$	$V_F$	1.15	1.26	1.45	V

### Output

Parameter	Test condition	Symbol	Min	Typ.	Max	Unit
ON-resistance	$I_F = 5.0\text{ mA}$ , $I_L = 50\text{ mA}$	$R_{ON}$	6.0	10	15	$\Omega$
Pole-to-pole ON-resistance matching (S1 to S2)	$I_F = 5.0\text{ mA}$ , $I_L = 50\text{ mA}$			0.1	1.0	$\Delta\Omega$
Off-resistance	$I_F = 0\text{ mA}$ , $V_L = \pm 100\text{ V}$	$R_{OFF}$	0.5	5000		$G\Omega$
Current limit	$I_F = 5.0\text{ mA}$ , $t = 5.0\text{ ms}$ , $V_L = \pm 5.0\text{ V}$	$I_{LMT}$	300	360	460	mA
Off-state leakage current	$I_F = 0\text{ mA}$ , $V_L = \pm 100\text{ V}$	$I_O$		0.02	200	nA
	$I_F = 0\text{ mA}$ , $V_L = \pm 200\text{ V}$	$I_O$			1.0	$\mu\text{A}$
Output capacitance	$I_F = 0\text{ mA}$ , $V_L = 1.0\text{ V}$	$C_O$		60		pF
	$I_F = 0\text{ mA}$ , $V_L = 50\text{ V}$	$C_O$		15		pF

Parameter	Test condition	Symbol	Min	Typ.	Max	Unit
Pole-to-pole capacitance (S1 to S2)	$I_F = 0 \text{ mA}$			3.0		pF
	$I_F = 5.0 \text{ mA}$			4.0		pF
Switch offset	$I_F = 5.0 \text{ mA}$	$V_{OS}$		0.15		V

## Transfer

Parameter	Test condition	Symbol	Min	Typ.	Max	Unit
Capacitance (input-output)	$V_{ISO} = 1.0 \text{ V}$	$C_{IO}$		1.1		pF
Turn-on time	$I_F = 10.0 \text{ mA}, I_L = 50 \text{ mA}$	$t_{on}$		1.6	2.5	ms
Turn-off time	$I_F = 10.0 \text{ mA}, I_L = 50 \text{ mA}$	$t_{off}$		0.65	2.5	ms

## Typical Characteristics ( $T_{amb} = 25^\circ\text{C}$ unless otherwise specified)

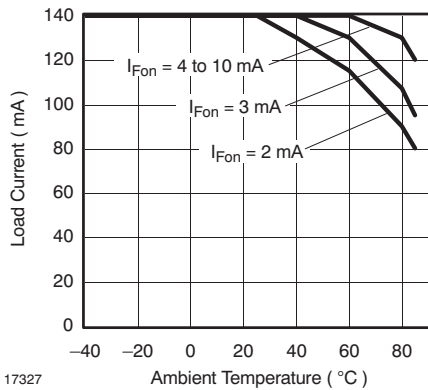

Figure 1. Recommended Operating Conditions

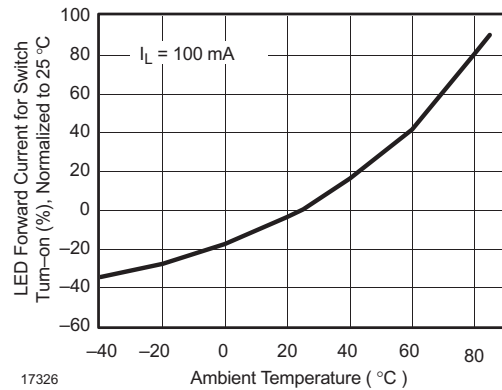

Figure 3. LED Current for Switch Turn-on vs. Temperature

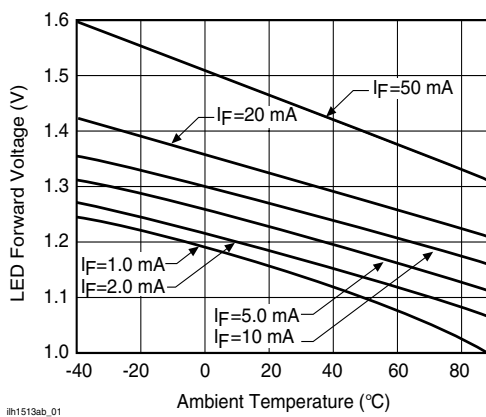

Figure 2. LED Voltage vs. Temperature

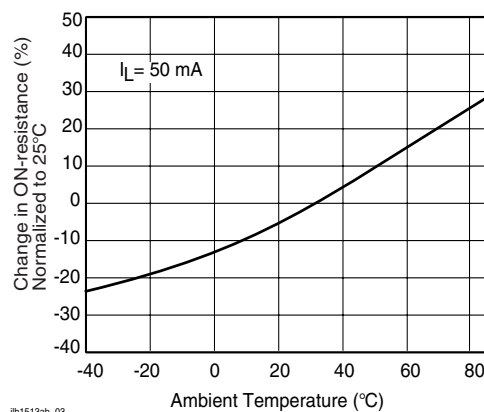

Figure 4. ON-Resistance vs. Temperature

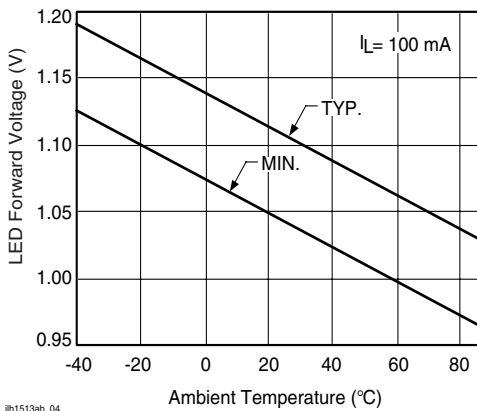

Figure 5. LED Dropout Voltage vs. Temperature

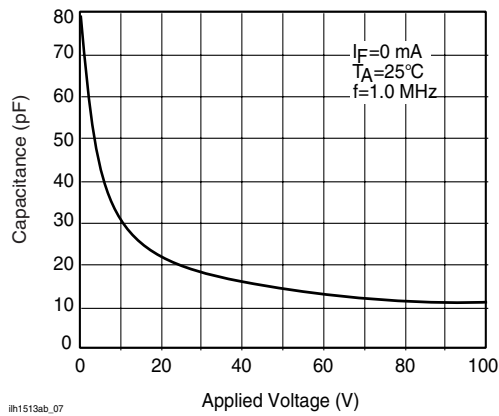

Figure 8. Switch Capacitance vs. Applied Voltage

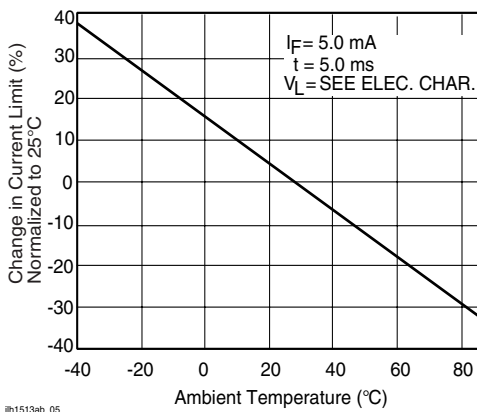

Figure 6. Current Limit vs. Temperature

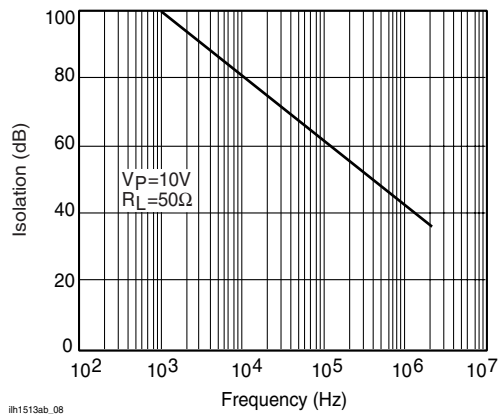

Figure 9. Output Isolation

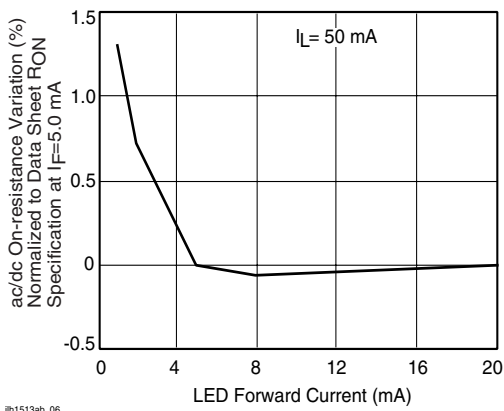

Figure 7. Variation in ON-Resistance vs. LED Current

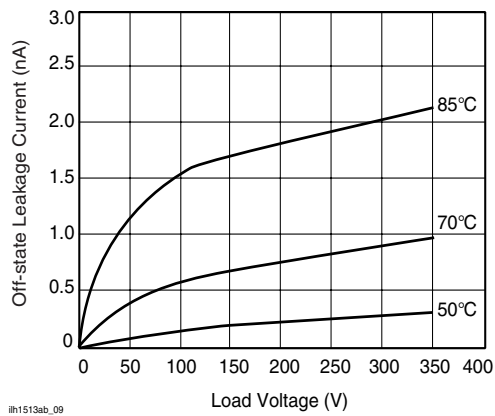
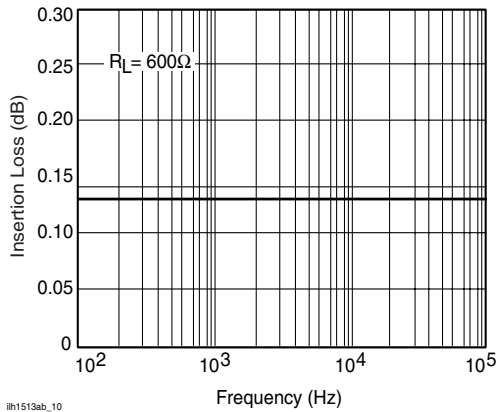
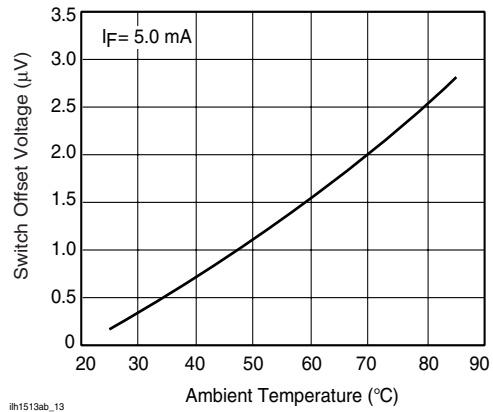

Figure 10. Leakage Current vs. Applied Voltage at Elevated Temperatures



ih1513ab\_10

Figure 11. Insertion Loss vs. Frequency



ih1513ab\_13

Figure 14. Switch Offset Voltage vs. Temperature

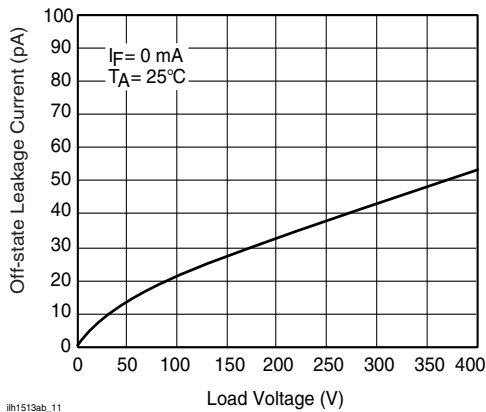

ih1513ab\_11

Figure 12. Leakage Current vs. Applied Voltage

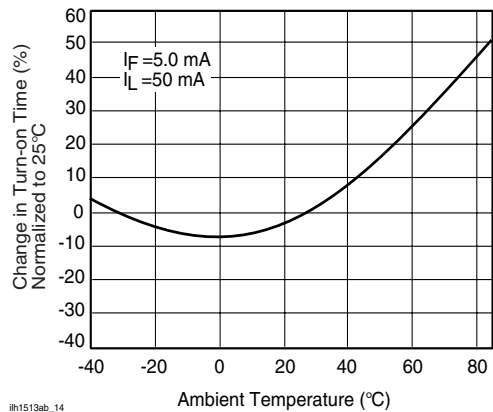

ih1513ab\_14

Figure 15. Turn-on Time vs. Temperature

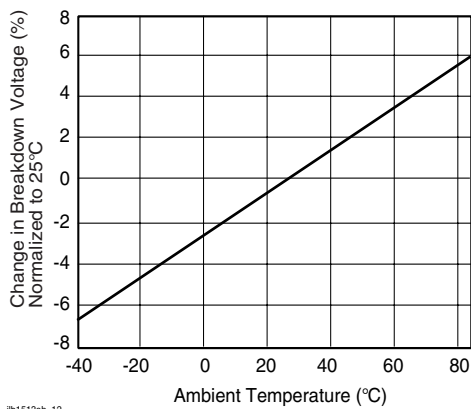

ih1513ab\_12

Figure 13. Switch Breakdown Voltage vs. Temperature

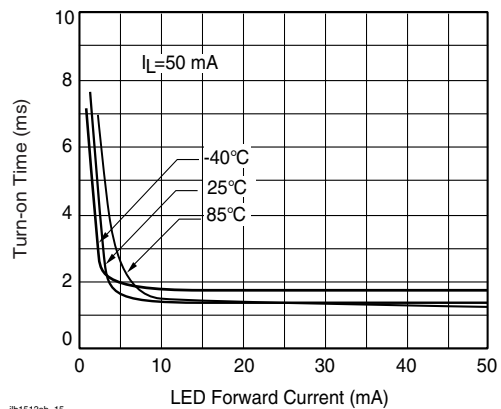

ih1513ab\_15

Figure 16. Turn-on Time vs. LED Current

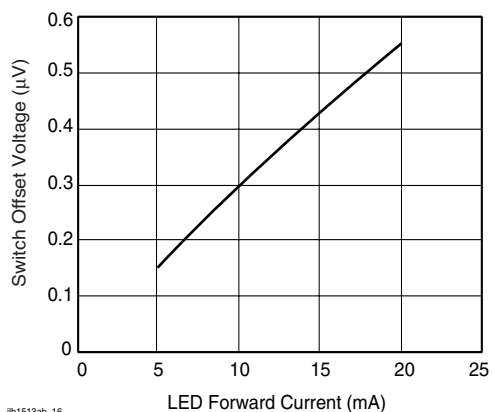

ih1513ab\_16

Figure 17. Switch Offset Voltage vs. LED Current

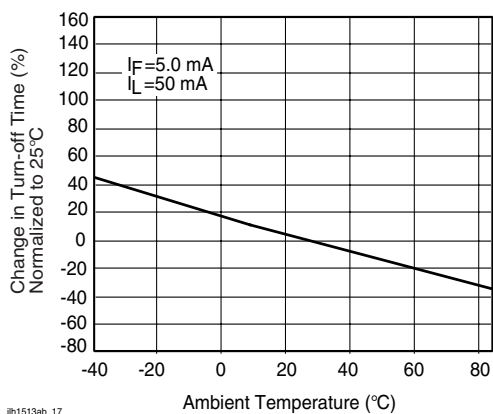

ih1513ab\_17

Figure 18. Turn-off Time vs. Temperature

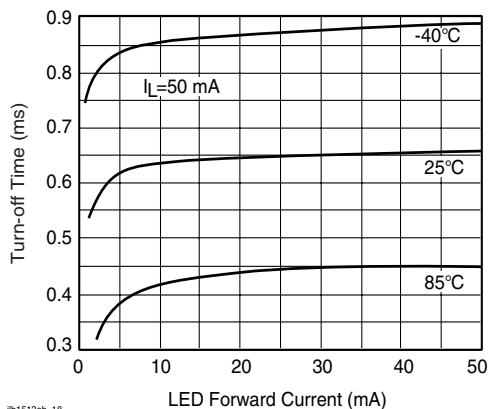

ih1513ab\_18

Figure 19. Turn-off Time vs. LED Current

## Package Dimensions in Inches (mm)

### DIP

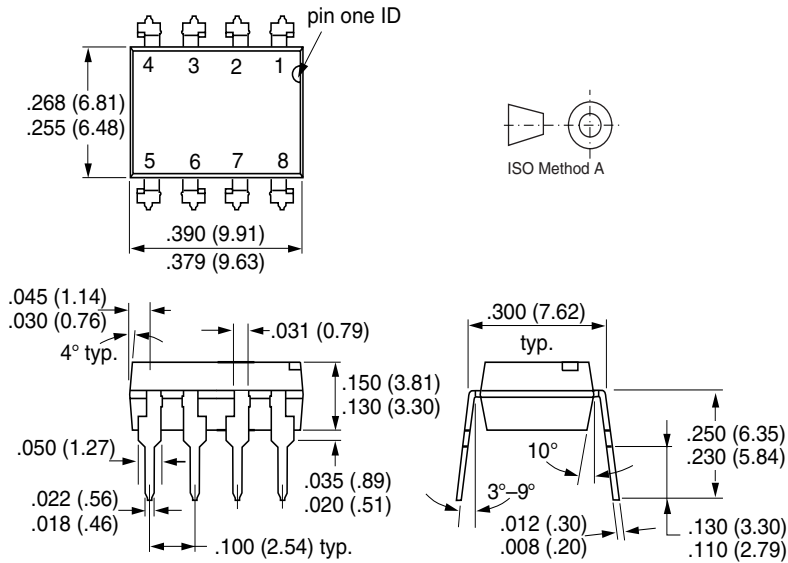

i178008

## Package Dimensions in Inches (mm)

### SMD

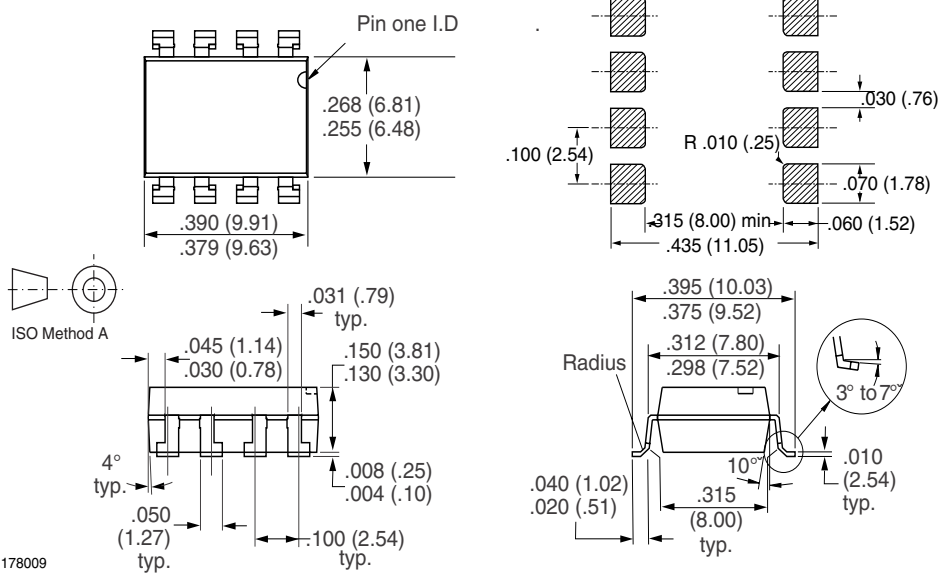

i178009

### Ozone Depleting Substances Policy Statement

It is the policy of Vishay Semiconductor GmbH to

1. Meet all present and future national and international statutory requirements.
2. Regularly and continuously improve the performance of our products, processes, distribution and operating systems with respect to their impact on the health and safety of our employees and the public, as well as their impact on the environment.

It is particular concern to control or eliminate releases of those substances into the atmosphere which are known as ozone depleting substances (ODSs).

The Montreal Protocol (1987) and its London Amendments (1990) intend to severely restrict the use of ODSs and forbid their use within the next ten years. Various national and international initiatives are pressing for an earlier ban on these substances.

Vishay Semiconductor GmbH has been able to use its policy of continuous improvements to eliminate the use of ODSs listed in the following documents.

1. Annex A, B and list of transitional substances of the Montreal Protocol and the London Amendments respectively
2. Class I and II ozone depleting substances in the Clean Air Act Amendments of 1990 by the Environmental Protection Agency (EPA) in the USA
3. Council Decision 88/540/EEC and 91/690/EEC Annex A, B and C (transitional substances) respectively.

Vishay Semiconductor GmbH can certify that our semiconductors are not manufactured with ozone depleting substances and do not contain such substances.

We reserve the right to make changes to improve technical design  
and may do so without further notice.

Parameters can vary in different applications. All operating parameters must be validated for each customer application by the customer. Should the buyer use Vishay Semiconductors products for any unintended or unauthorized application, the buyer shall indemnify Vishay Semiconductors against all claims, costs, damages, and expenses, arising out of, directly or indirectly, any claim of personal damage, injury or death associated with such unintended or unauthorized use.

Vishay Semiconductor GmbH, P.O.B. 3535, D-74025 Heilbronn, Germany  
Telephone: 49 (0)7131 67 2831, Fax number: 49 (0)7131 67 2423





---

**Notice**

Specifications of the products displayed herein are subject to change without notice. Vishay Intertechnology, Inc., or anyone on its behalf, assumes no responsibility or liability for any errors or inaccuracies.

Information contained herein is intended to provide a product description only. No license, express or implied, by estoppel or otherwise, to any intellectual property rights is granted by this document. Except as provided in Vishay's terms and conditions of sale for such products, Vishay assumes no liability whatsoever, and disclaims any express or implied warranty, relating to sale and/or use of Vishay products including liability or warranties relating to fitness for a particular purpose, merchantability, or infringement of any patent, copyright, or other intellectual property right.

The products shown herein are not designed for use in medical, life-saving, or life-sustaining applications. Customers using or selling these products for use in such applications do so at their own risk and agree to fully indemnify Vishay for any damages resulting from such improper use or sale.