

1SS-Series Ordering Scheme



1 SERIES
1SS Sealed Sub-Miniature Rocker Switch

2 POLES
WMSP single pole - uses terminals 1, 2 & 3.
WMDP double pole uses terminals 1, 2, 3, 4, 5 & 6.

3 CIRCUIT
 () - momentary

Switching Position:			
	2-3, 5-6	OPEN	2-1, 5-4
1	ON	NONE	ON
2	ON	NONE	(ON)
3	ON	OFF	ON
4	(ON)	OFF	(ON)
5	ON	OFF	(ON)

4 ACTUATOR STYLE
R1 Small rocker **R2** Narrow rocker

5 ACTUATOR COLOR¹

1 white	4 orange	7 blue
2 black	5 yellow	8 brown
3 red	6 green	9 gray

1 White, black & red are standard. Other colors available for quantities of 5K or more.

6 TERMINATION
M1 Solder Lug
M2 PCB
M6 PC Mount, 90° horizontal
M7 PC Mount, 90° vertical
VS2 PC Mount, U bracket, .620 mounting x .460 high
M61 Snap-In, U bracket, 90° horizontal
M71 Snap-In, U bracket, 90° vertical
VS21 Snap-In, U bracket, .620 mounting x .460 high

7 CONTACT

	Material	Terminal Plating	Rating	IP67
G	silver ¹	gold over silver ³	3A@125VAC or 28VDC, 1.5A @ 250VAC	IP67
K	gold ²	tin-lead ⁴	0.4VA max. @20V max (AC/DC)	IP67
P	silver ¹	tin-lead ⁴	3A@125VAC or 28VDC, 1.5A @ 250VAC	IP67
R	gold ²	gold ²	0.4VA max. @20V max (AC/DC)	IP67

NOTE:
 Standard G plating for sealed product.
 Tin-lead option available with PC type terminations only.
 1 Moveable contact & terminals: copper alloy, silver plate
 2 Moveable contact & terminals: copper alloy with gold plated over nickel plate
 3 Terminals: silver plated with outer layer in gold plating
 4 Outer terminals: copper alloy with tin-lead over nickel plate

8 EPOXY SEAL
E epoxy seal

1SM-Series Ordering Scheme



1 SERIES
1SM Sealed Surface Mount Sub-Miniature Rocker Switch

2 POLES
WMSP single pole - uses terminals 1, 2 & 3.

3 CIRCUIT
 () - momentary

Switching Position:			
	2-3	OPEN	2-1
1	ON	NONE	ON
2	ON	NONE	(ON)
3	ON	OFF	ON
4	(ON)	OFF	(ON)
5	ON	OFF	(ON)

4 ACTUATOR STYLE
R2 Narrow black rocker

5 TERMINATION
M6 Surface Mount, 90° flat - horizontal/side terms
S6 Surface Mount, 90° horizontal/back terms
S7 Surface Mount, 90° vertical

6 CONTACT

	Material	Terminal Plating	Rating	IP67
G	silver ¹	gold over silver ³	3A@125VAC or 28VDC, 1.5A @ 250VAC	IP67
K	gold ²	tin-lead ⁴	0.4VA max. @20V max (AC/DC)	IP67
P	silver ¹	tin-lead ⁴	3A@125VAC or 28VDC, 1.5A @ 250VAC	IP67
Q	silver ¹	silver ¹	3A@125VAC or 28VDC, 1.5A @ 250VAC	IP67
R	gold ²	gold ²	0.4VA max. @20V max (AC/DC)	IP67

NOTE:
 Standard G plating for sealed product. P&K for PC mount only.
 Tin-lead option available with PC type terminations only.
 1 Moveable contact & terminals: copper alloy, silver plate
 2 Moveable contact & terminals: copper alloy with gold plate over nickel plate
 3 Terminals: silver plated with outer layer in gold plating
 4 Outer terminals: copper alloy with tin-lead over nickel plate

7 EPOXY SEAL
E epoxy seal

8 PACKAGING
 Switches are bulk packed, unless **T/R** is specified at the end of the part number.

T/R tape reel - 500 pieces per reel

1S-Series Dimensional Specifications: in. [mm]

ACTUATOR

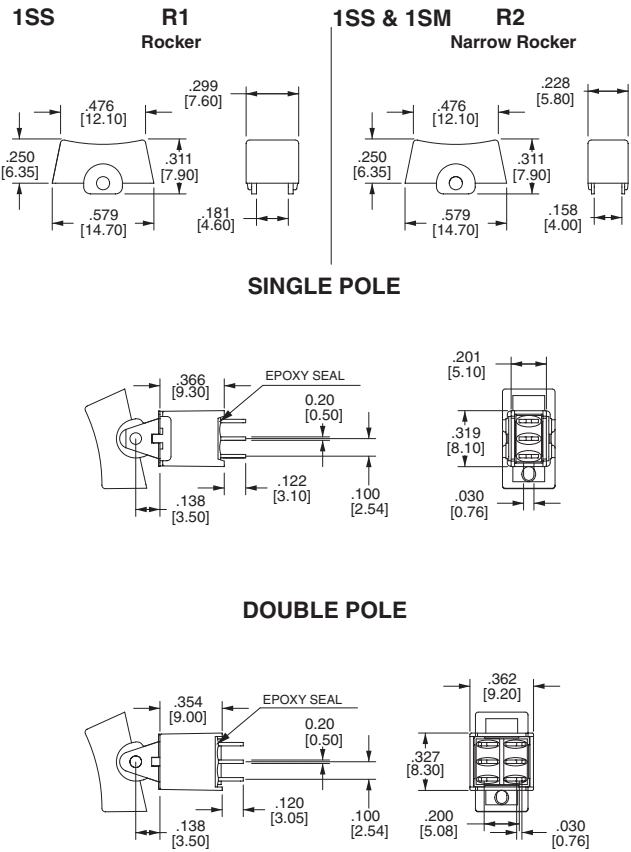
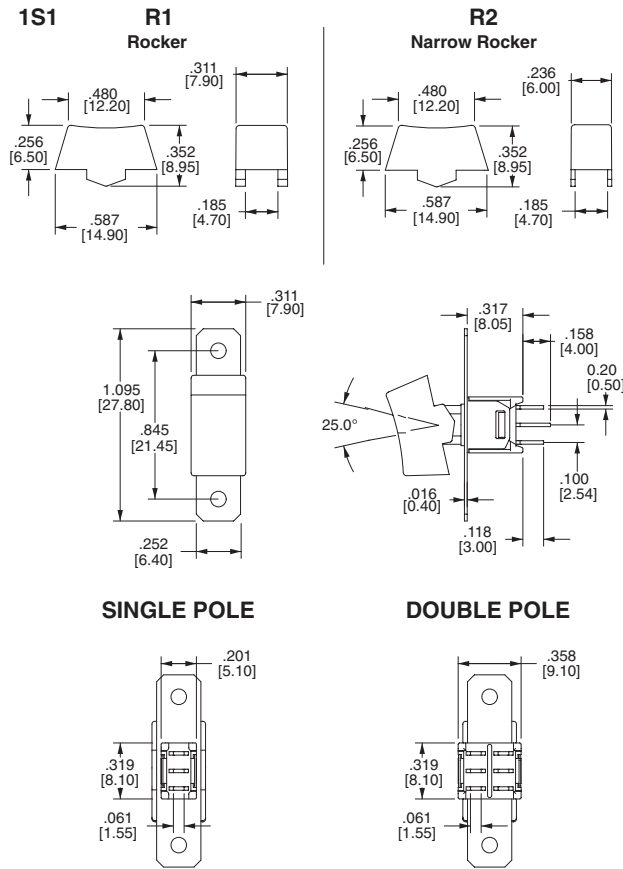

TERMINATION

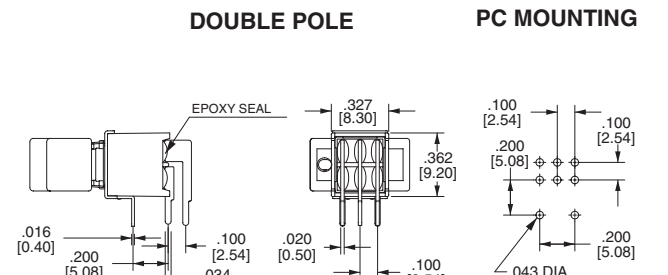
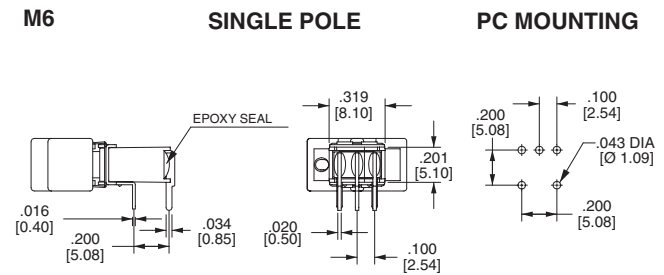
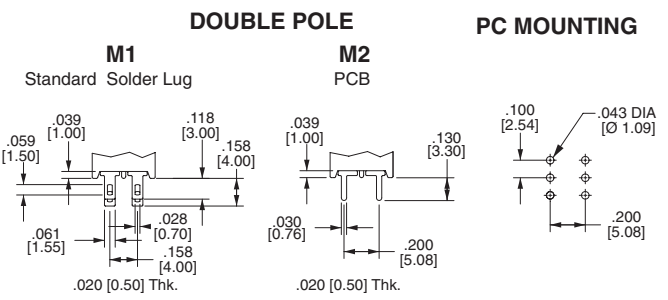
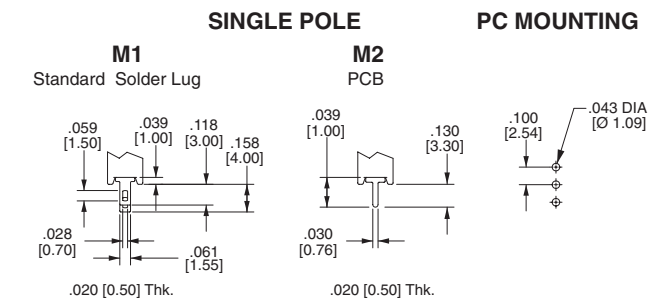

1S-Series Dimensional Specifications: in. [mm]

TERMINATION

M7 SINGLE POLE

PC MOUNTING

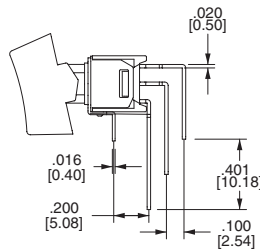
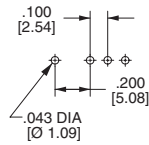
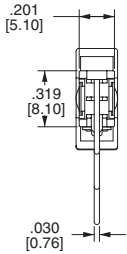

DOUBLE POLE

PC MOUNTING

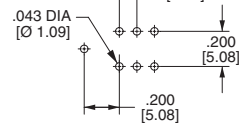
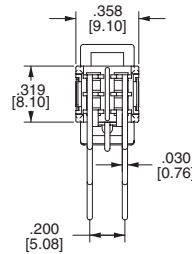

VS2

PC MOUNTING

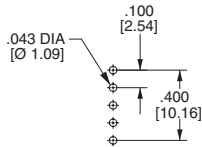
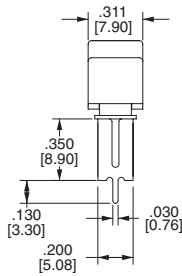

SINGLE POLE

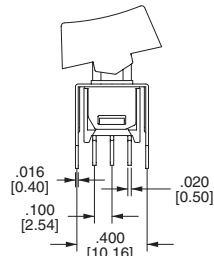

VS3

PC MOUNTING

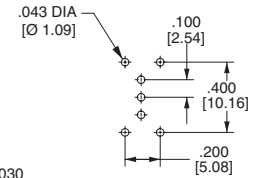
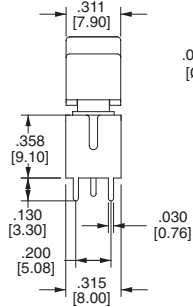

VS2

PC MOUNTING

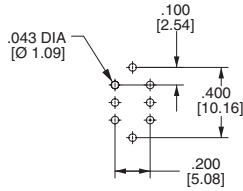
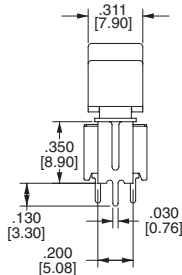

DOUBLE POLE

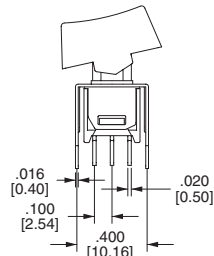

VS3

PC MOUNTING

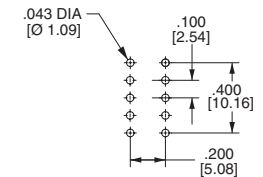
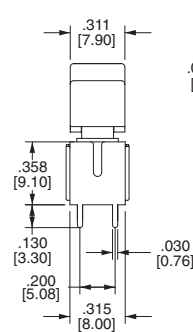

SNAP-IN TERMINATION

M61

M71

VS21

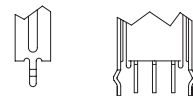
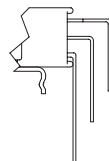
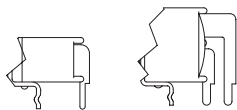

1SM-Series Dimensional Specifications: in. [mm]

TERMINATION

M6

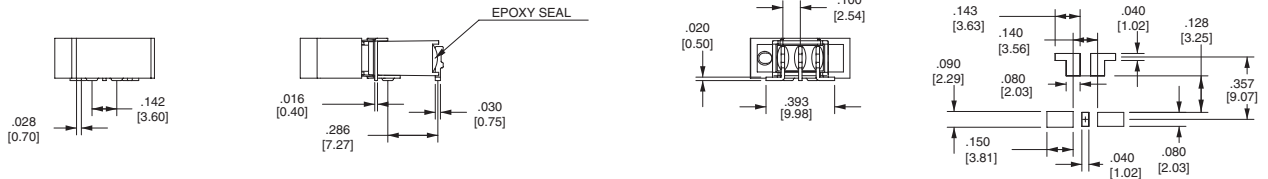

S6

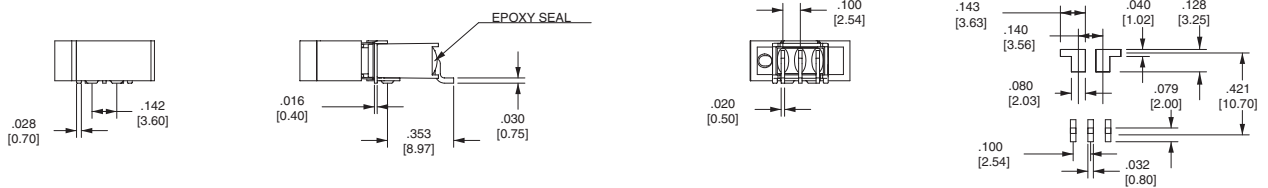

S7

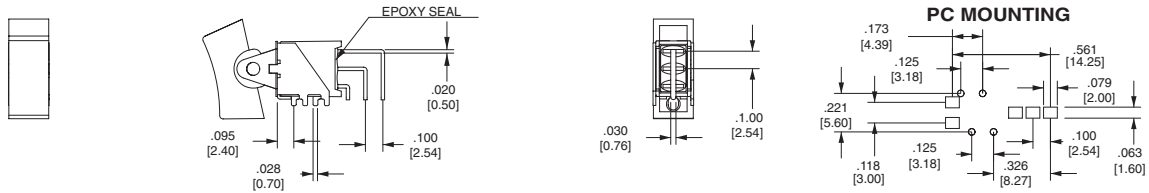

REEL TAPING

