

PART NO. ENG. NO.

02-06-2131	1854-(901)	
02-06-2132	1854-(901)L	
02-06-2134	1854-(901)1	OBSOLETE
02-06-6137	1854-(591)	
02-06-6136	1854-(591)L	
02-06-6138	1854-(561)	
02-06-6139	1854-(561)L	
02-06-6130	1854-(550)	
02-06-6135	1854-(550)L	
02-06-6143	1854-(228)	
02-06-6144	1854-(228)L	
02-06-6145	1854-(603)1	OBSOLETE

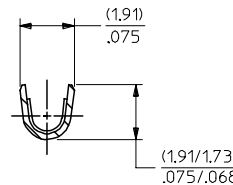

SECT. "B-B"
SCALE:10X

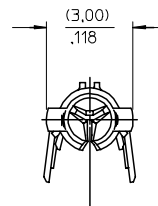
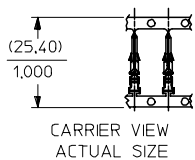
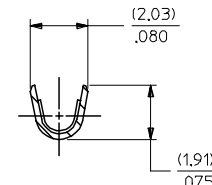

SECT. "C-C"
SCALE:10X

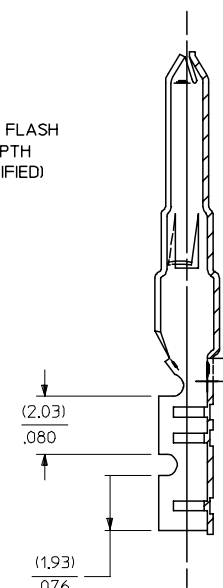
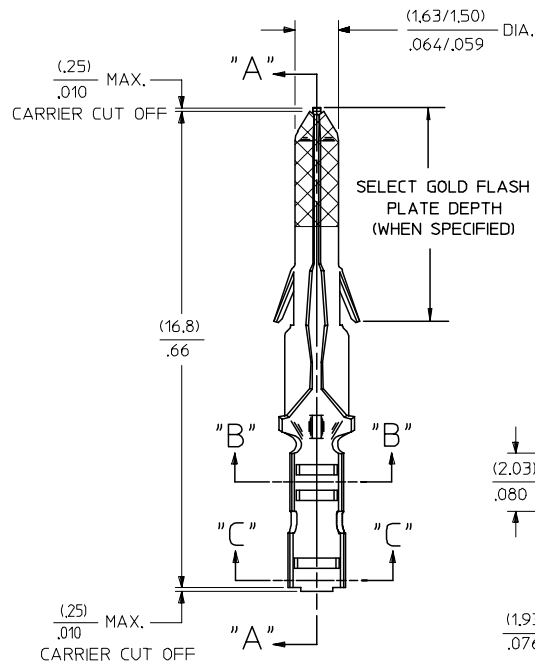

SECT. "A-A"

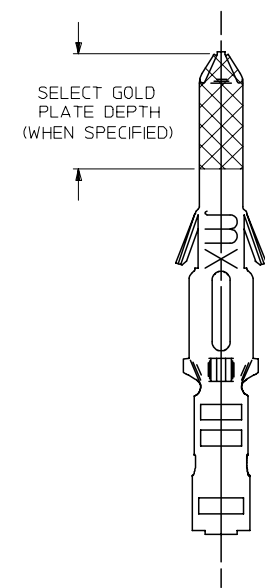

LEGEND

1854-(****)*

- P=PREPLATE
- BLANK=POSTPLATE
- FINISH CODE
- FORM BLANK=CHAIN
- 1=CHAIN WITH INTERLEAF PAPER ON REEL.
- L=LOOSE

NOTES:

1. MATERIAL: BRASS
2. FINISHES:
 - 901 HOT TIN DIP (.00051)/.000020 MIN.
 - * 228 SELECT GOLD PLATE (.00075)/.000030 MIN. IN CONTACT AREA, SELECT TIN (.00250)/.000100 MIN. IN CRIMP AREA OVER (.00125)/.000050 MIN. NICKEL OVERALL, WITH (.000010)/.000025 MAX. SELECT GOLD FLASH AS INDICATED.
 - 561 SELECT GOLD PLATE (.00076)/.000030 MIN. IN CONTACT AREA, (.00127)/.000050 MIN. NICKEL OVERALL.
 - 591 SELECT GOLD PLATE (.00127)/.000050 MIN. IN CONTACT AREA, OVER (.00127)/.000050 MIN. NICKEL OVERALL WITH (.00025)/.000010 MAX. GOLD FLASH OVERALL.
 - 550 SELECT GOLD PLATE (.00038)/.000015 MIN. IN CONTACT AREA, OVER (.00076)/.000030 MIN. NICKEL OVERALL WITH (.00025)/.000010 MAX. GOLD FLASH OVERALL.
 - * THE PRIMARY SHIPPING CARTON WILL BE LABELED, "COMPLIANT TO RoHS DIRECTIVE 2002/95/EC AND ELV ANNEX II OF DIRECTIVE 2000/53/EC", CARTONS WITHOUT THIS LABEL MAY CONTAIN PRODUCT WITH TIN-LEAD.
3. PRODUCT SPECIFICATIONS: PS-02-06
4. PACKAGING INFORMATION: NOT AVAILABLE
5. TERMINAL FOR USE WITH (1.57)/0.062 DIA. SERIES HOUSINGS AND WILL ACCEPT 24 THRU 30 AWG. WIRE WITH (1.02/2.29)/0.040/0.090 INSULATION DIA.

WORK AREA PLOT

EC NO:	AP	DESCRIPTION
REV		

THIRD ANGLE PROJECTION

AP	REMV Sn/Pb PLATING REDRAWN TO ME10 UCP2004-2097 RHOLTS 5/07/04
AN	OBSOLETE P/N UCR2002-0270 COMERC 01/9/27
AM2	OBSOLETE -675 & -675L ECR U6 0358 9/15/95 RW
AM1	ADD -(603)1 PER ERO #30605 11-5-90 RW
AM	REV. & REDRAWN PER ECR 10372 GEP 9-21-87 RW