

**TLRH1106(T11), TLRMH1106(T11), TLSH1106(T11),  
TLOH1106(T11), TLYH1106(T11) , TLGH1106(T11)**

Panel Circuit Indicator

- Surface-mount devices
- 3.2 (L) × 2.8 (W) × 1.9 (H) mm
- Flat-top type
- InGaAlP LEDs
- High luminous intensity
- Low drive current, high-intensity light emission
- Colors: red, orange, yellow, green
- Pb-free reflow soldering is possible
- Applications: automotive use,  
message signboards, backlighting etc.
- Standard embossed tape packing: T11 (2000/reel)  
8-mm tape reel

Unit: mm

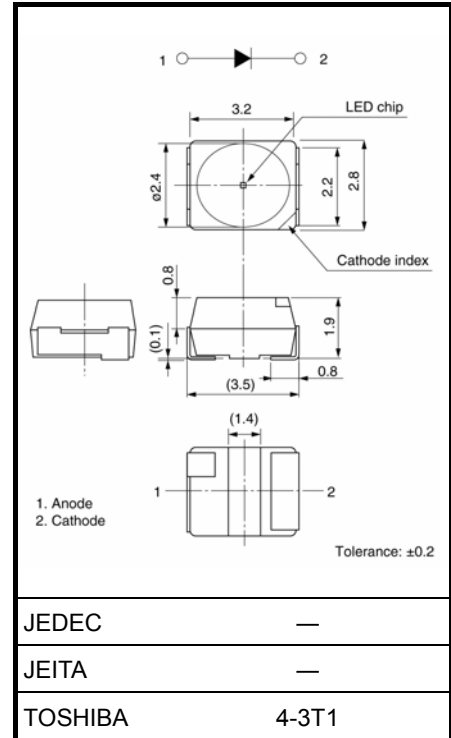

Weight: 0.035 g (typ.)

**Color and Material**

Product Name	Color	Material
TLRH1106	Red	InGaAlP
TLRMH1106	Red	
TLSH1106	Red	
TLOH1106	Orange	
TLYH1106	Yellow	
TLGH1106	Green	

## Maximum Ratings (Ta = 25°C)

Product Name	Forward Current I <sub>F</sub> (mA) Please see Note 1	Reverse Voltage V <sub>R</sub> (V)	Power Dissipation P <sub>D</sub> (mW)	Operation Temperature T <sub>opr</sub> (°C)	Storage Temperature T <sub>stg</sub> (°C)
TLRH1106	70	4	175	-40~100	-40~100
TLRMH1106					
TLSH1106					
TLOH1106					
TLYH1106					
TLGH1106					

Note 1: Forward current derating

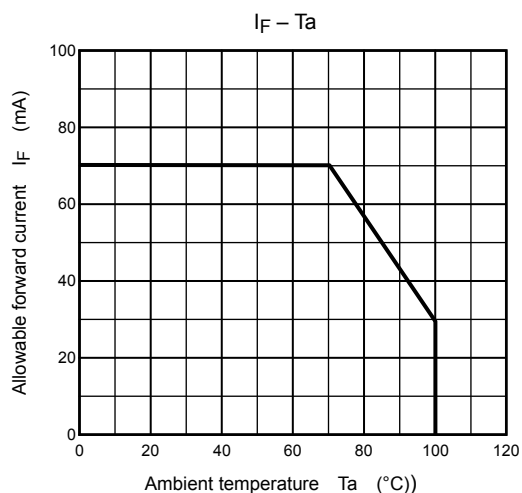

## Electrical Characteristics (Ta = 25°C)

Product Name	Forward Voltage V <sub>F</sub>			Reverse Current I <sub>R</sub>		
	Min	Typ.	Max	I <sub>F</sub>	V <sub>R</sub>	
TLRH1106	1.8	2.1	2.5	50	10	4
TLRMH1106	1.8	2.1	2.5			
TLSH1106	1.8	2.2	2.5			
TLOH1106	1.8	2.2	2.5			
TLYH1106	1.8	2.2	2.5			
TLGH1106	1.8	2.2	2.5			
Unit	V			mA	μA	V

## Optical Characteristics-1 (Ta = 25°C)

Product Name	Luminous Intensity I <sub>v</sub>				Available I <sub>v</sub> rank Please see Note 2
	Min	Typ.	Max	I <sub>F</sub>	
TLRH1106	160	380	800	50	SA / TA / UA
TLRMH1106	160	380	800	50	SA / TA / UA
TLSH1106	250	500	1250	50	TA / UA / VA
TLOH1106	250	600	1250	50	TA / UA / VA
TLYH1106	250	450	1250	50	TA / UA / VA
TLGH1106	100	200	500	50	RA / SA / TA
Unit	mcd	mcd	mcd	mA	

Note 2: The specification on the above table is used for I<sub>v</sub> classification of LEDs in Toshiba facility.  
Each reel includes the same rank LEDs. Let the delivery ratio of each rank be unquestioned.

Rank	Luminous Intensity I <sub>v</sub>	
	Min	Max
RA	100	200
SA	160	320
TA	250	500
UA	400	800
VA	630	1250
Unit	mcd	mcd

## Optical Characteristics-2 (Ta = 25°C)

Product Name	Emission Spectrum							
	Peak Emission Wavelength λ <sub>p</sub>			Δλ Typ.	Dominant Wavelength λ <sub>d</sub>			I <sub>F</sub>
	Min	Typ.	Max		Min	Typ.	Max	
TLRH1106	—	644	—	18	624	630	638	50
TLRMH1106	—	636	—	17	620	626	634	
TLSH1106	—	623	—	17	607	613	621	
TLOH1106	—	612	—	15	599	605	613	
TLYH1106	—	590	—	15	581	587	595	
TLGH1106	—	574	—	11	565	571	576	
Unit	nm			nm	nm			mA

## The cautions

- This visible LED lamp also emits some IR light  
If a photodetector is located near the LED lamp, please ensure that it will not be affected by the IR light.
- This product is designed as a general display light source usage, and it has applied the measurement standard that matched with the sensitivity of human's eyes. Therefore, it is not intended for usage of functional application (ex. Light source for sensor, optical communication and etc) except general display light source.

**TLRH1106**

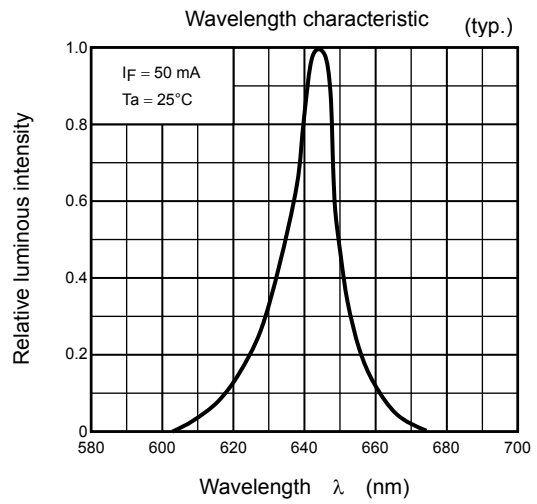
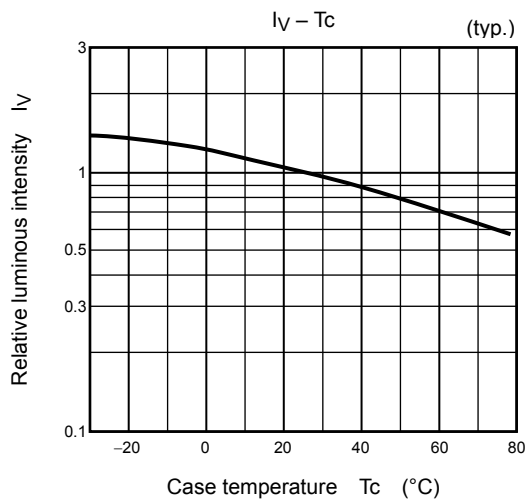
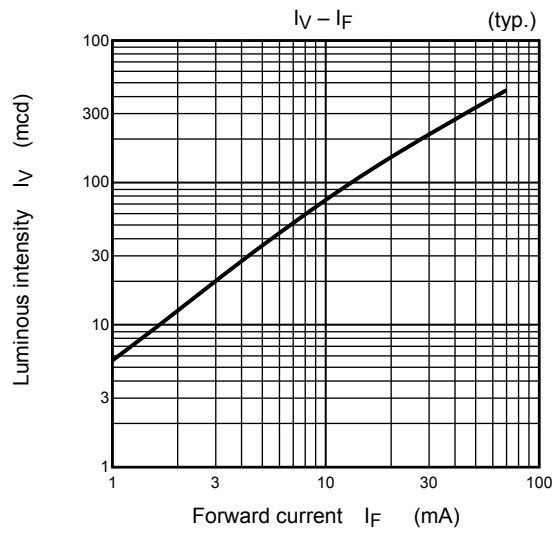
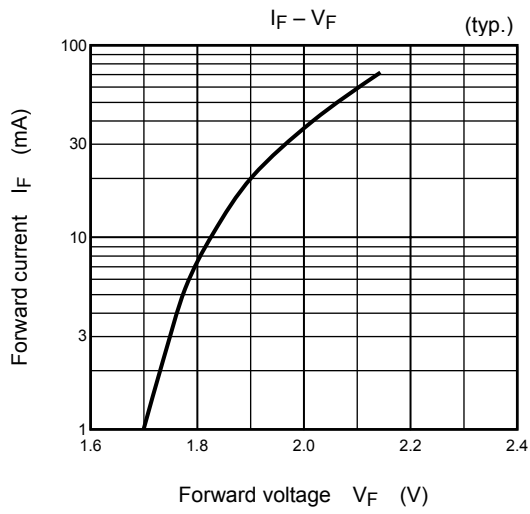

Radiation pattern

$T_a = 25^\circ\text{C}$   
(typ.)

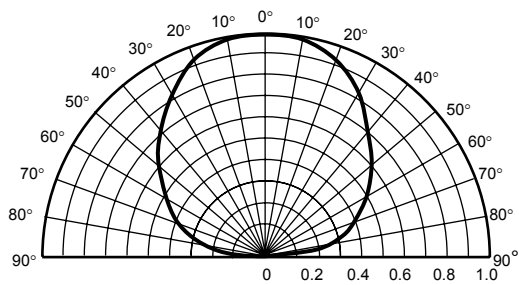

**TLRMH1106**

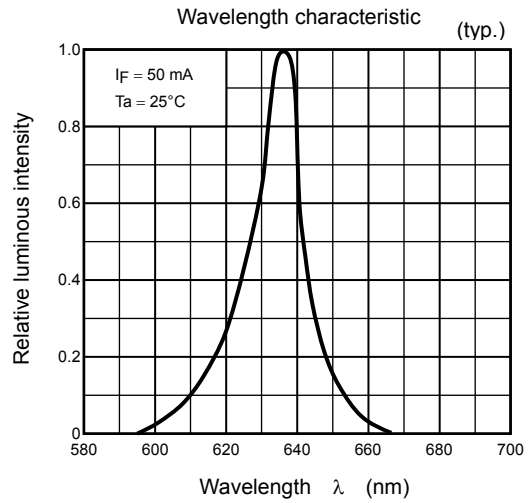
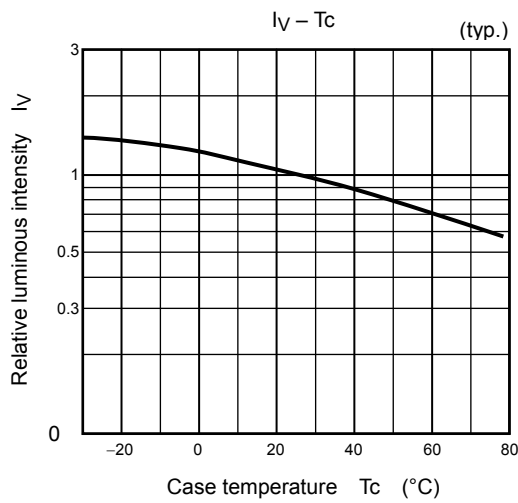
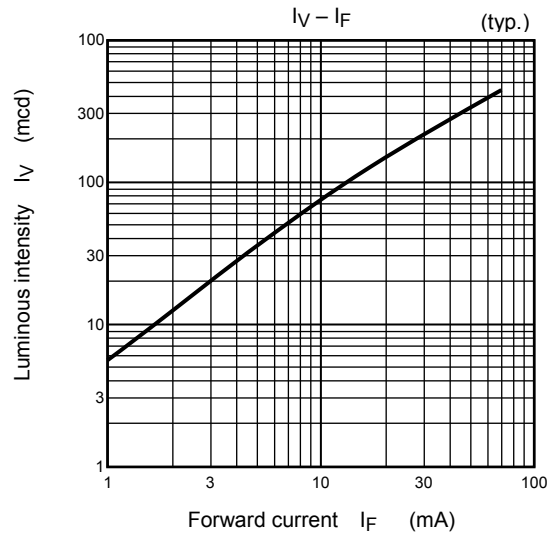
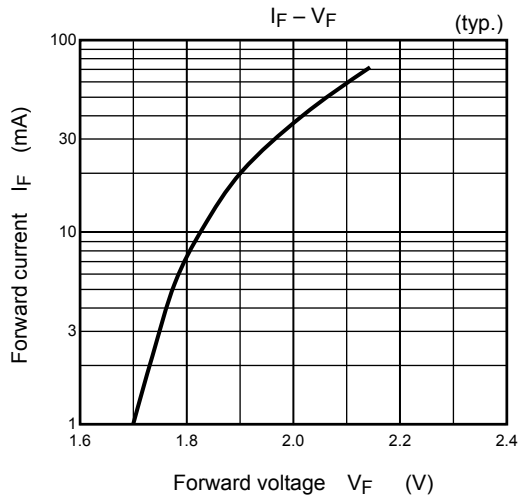

Radiation pattern

$T_a = 25^\circ \text{C}$   
(typ.)

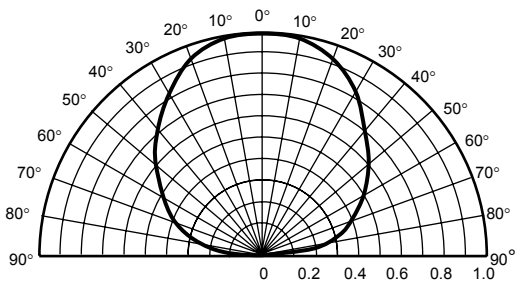

**TLSH1106**

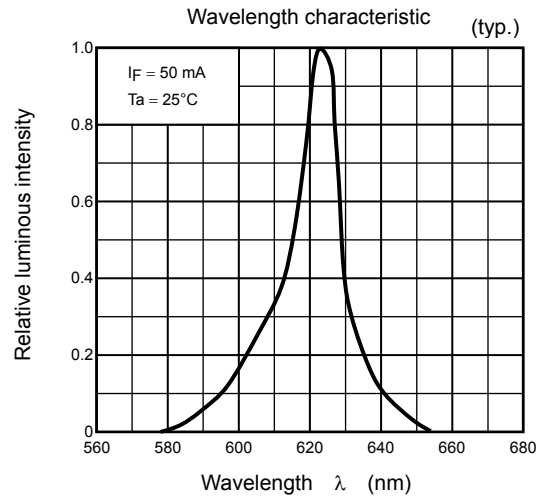
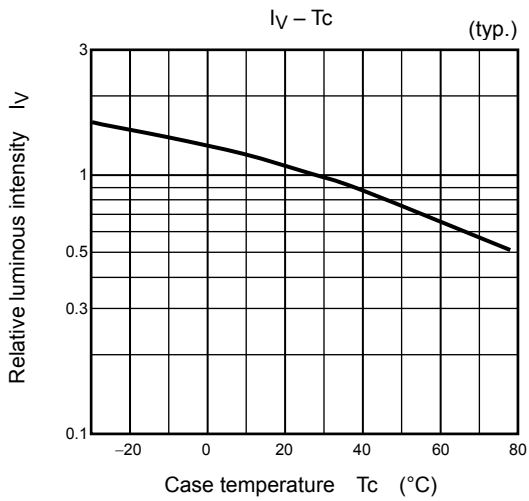
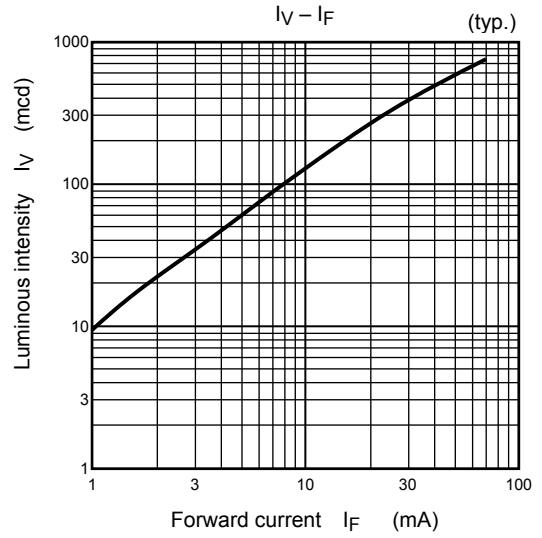
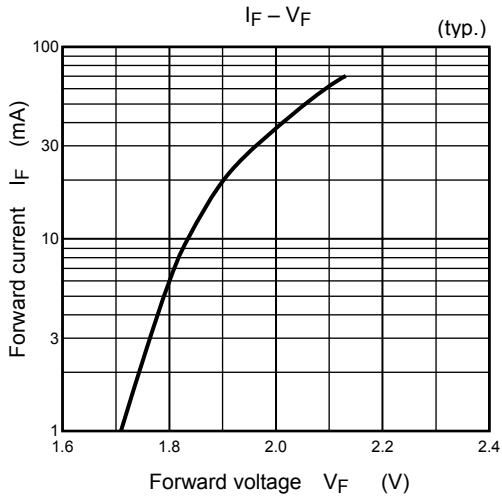

Radiation pattern

$T_a = 25^\circ\text{C}$   
(typ.)

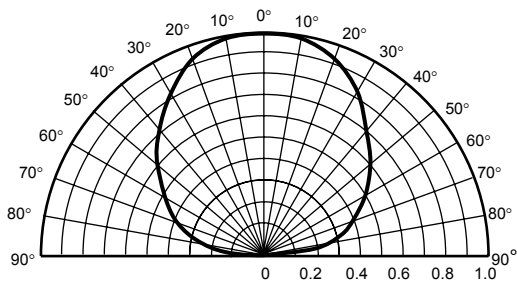

## TLOH1106

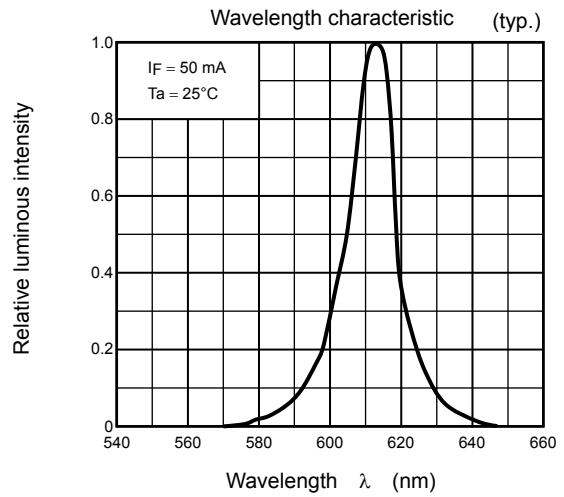
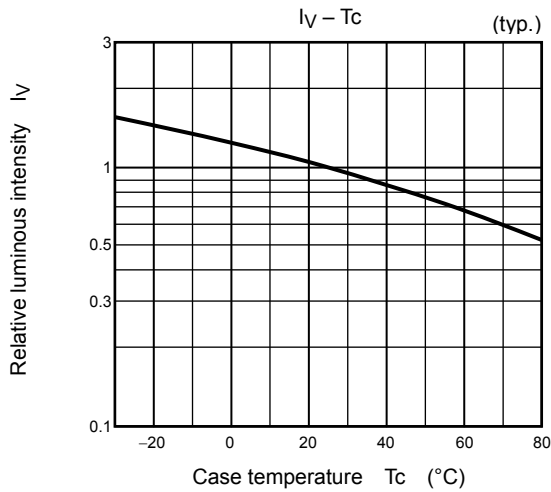
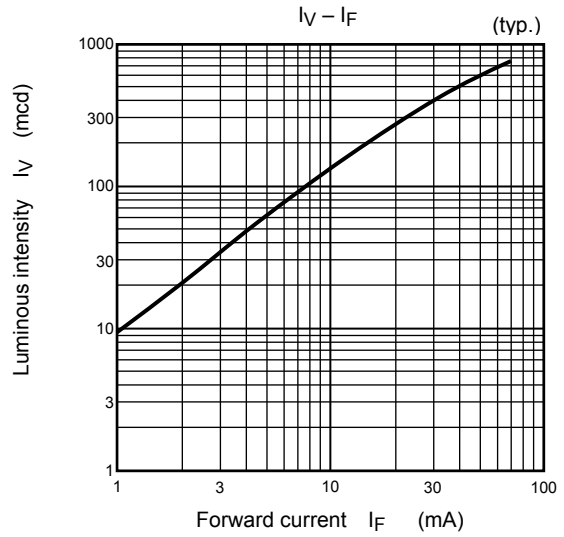
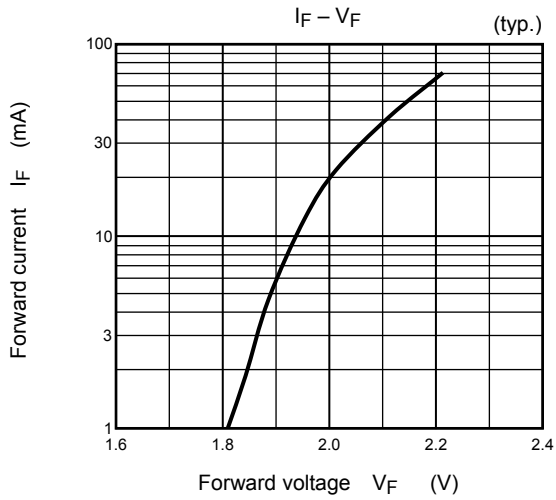

### Radiation pattern

$T_a = 25^\circ \text{C}$   
(typ.)

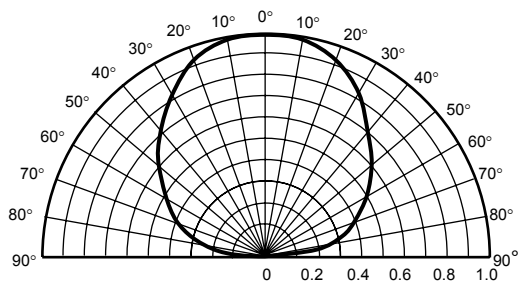

**TLYH1106**

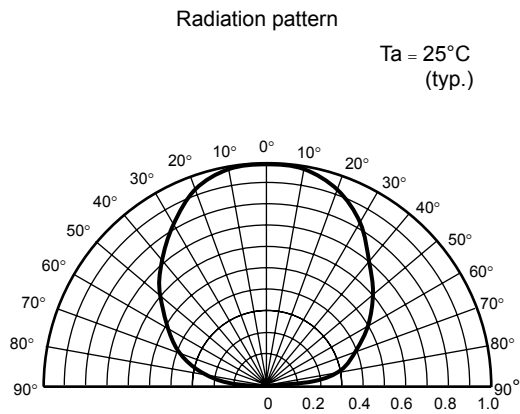
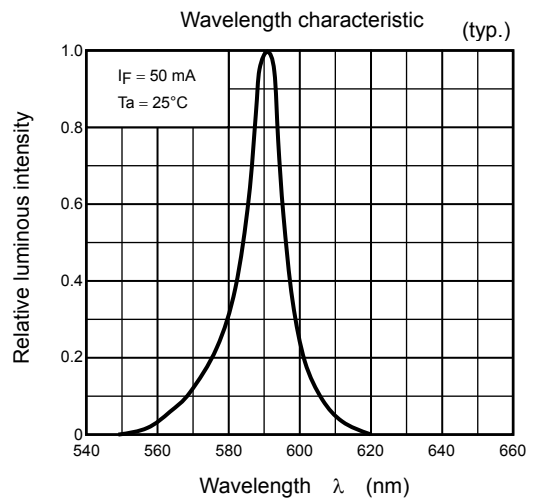
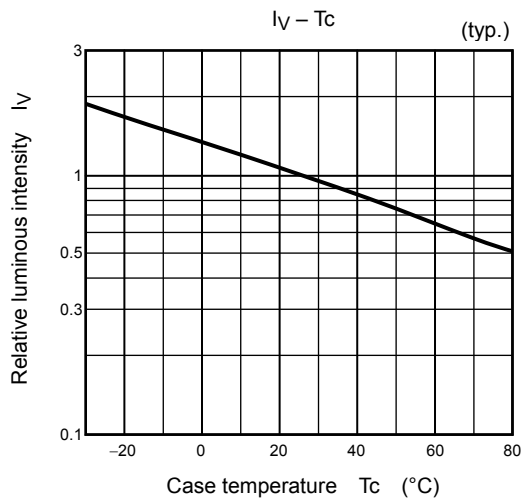
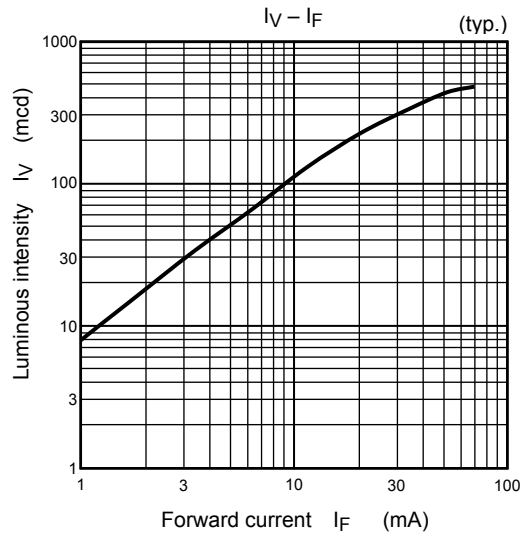
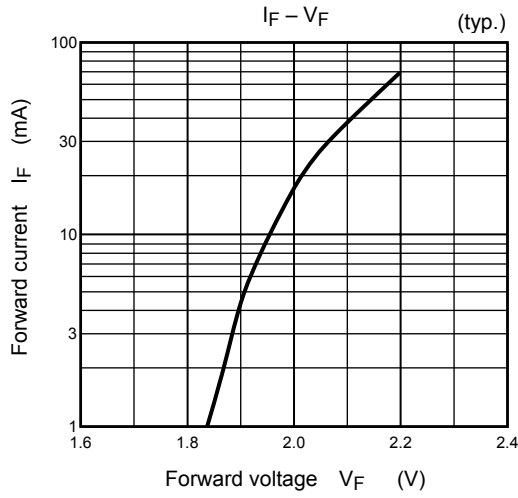



**TLGH1106**

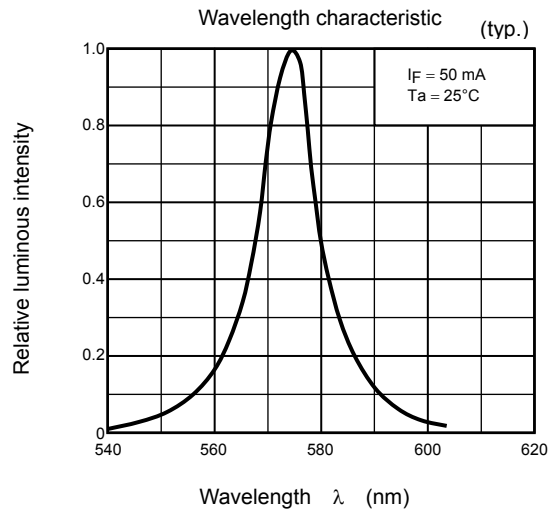
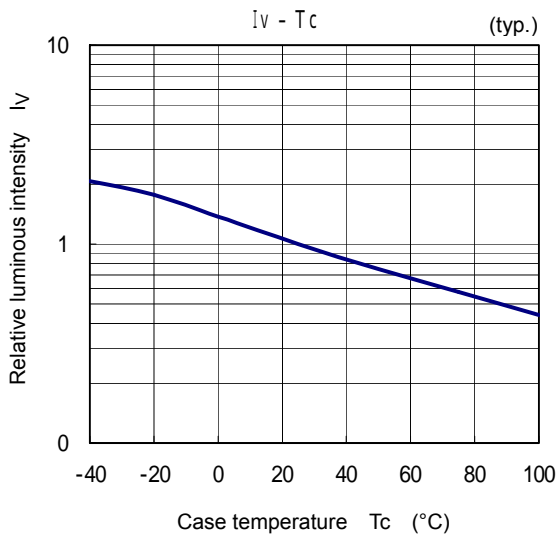
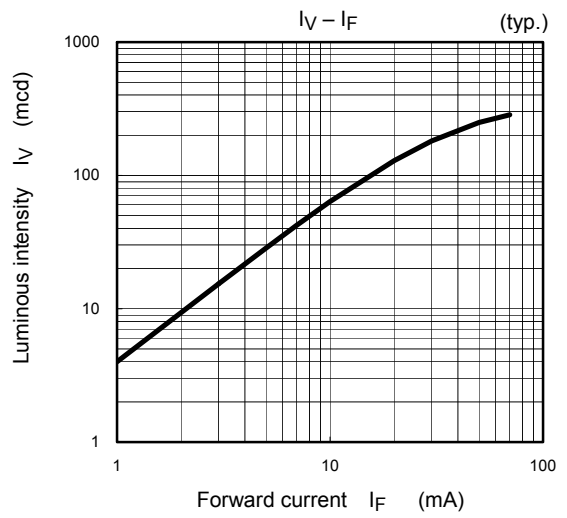
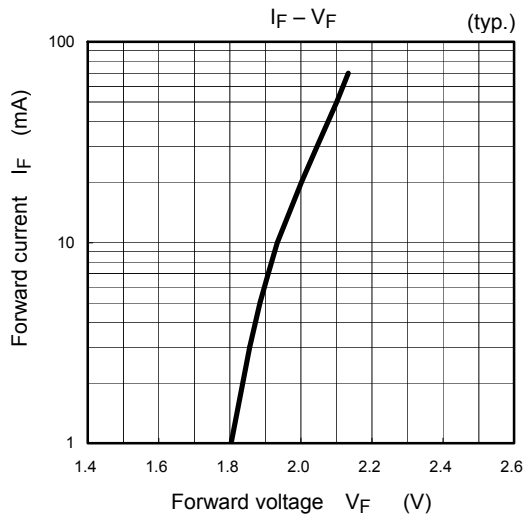

Radiation pattern

$T_a = 25^\circ\text{C}$   
(typ.)

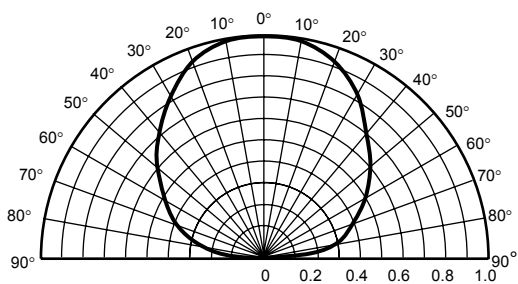

## Packaging

These LED devices are packed in an aluminum envelope with a silica gel and a moisture indicator to avoid moisture absorption. The optical characteristics of the devices may be affected by exposure to moisture in the air before soldering and they should therefore be stored under the following conditions:

1. This moisture proof bag may be stored unopened within 12 months at the following conditions.  
 Temperature: 5°C~30°C  
 Humidity: 90% (max)
2. After opening the moisture proof bag, the devices should be assembled within 168 hours in an environment of 5°C to 30°C/60% RH or below.
3. If upon opening, the moisture indicator card shows humidity 30% or above (Color of indication changes to pink) or the expiration date has passed, the devices should be baked in taping with reel.  
 After baking, use the baked devices within 72 hours, but perform baking only once.  
 Baking conditions: 60±5°C, for 12 to 24 hours.  
 Expiration date: 12 months from sealing date, which is imprinted on the same side as this label affixed.
4. Repeated baking can cause the peeling strength of the taping to change, then leads to trouble in mounting. Furthermore, prevent the devices from being destructed against static electricity for baking of it.
5. If the packing material of laminate would be broken, the hermeticity would deteriorate. Therefore, do not throw or drop the packed devices.

## Mounting Method

### Soldering

- Reflow soldering (example)

Temperature profile for Pb soldering (example)

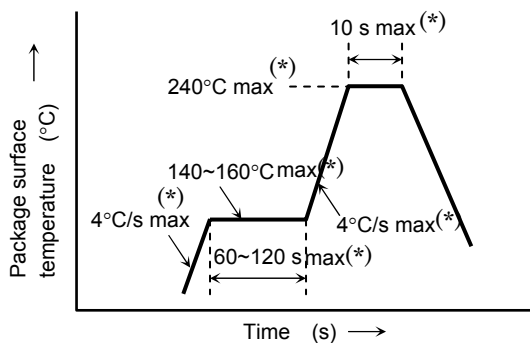

Temperature profile for Pb-free soldering (example)

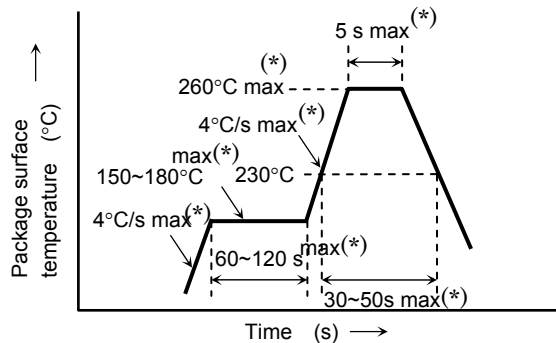

- The products are evaluated using above reflow soldering conditions. No additional test is performed exceed the condition (i.e. the condition more than (\*)MAX values) as a evaluation. Please perform reflow soldering under the above conditions.
- Please perform the first reflow soldering with reference to the above temperature profile and within 168 h of opening the package.
- Second reflow soldering  
 In case of second reflow soldering should be performed within 168 h of the first reflow under the above conditions.  
 Storage conditions before the second reflow soldering: 30°C, 60% RH (max)
- Make any necessary soldering corrections manually.  
 (only once at each soldering point)  
 Soldering iron: 25 W  
 Temperature : 300°C or less  
 Time : within 3 s
- If the products need to be performed by other soldering method (ex. wave soldering), please contact Toshiba sales representative.

### Recommended soldering pattern

Unit: mm

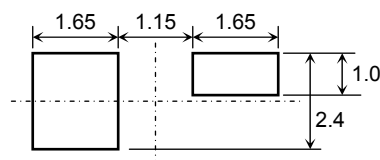

Recommended Cu area: Anode terminal	24mm <sup>2</sup> min
Cathode terminal	24mm <sup>2</sup> min

**Cleaning**

When cleaning is required after soldering, Toshiba recommends the following cleaning solvents. It is confirmed that these solvents have no effect on semiconductor devices in our dipping test (under the recommended conditions). In selecting the one for your actual usage, please perform sufficient review on washing condition, using condition and etc.

- ASAHI CLEAN AK-225AES : (made by ASAHI GLASS)
- KAO CLEAN TROUGH 750H : (made by KAO)
- PINE ALPHA ST-100S : (made by ARAKAWA CHEMICAL)
- TOSHIBA TECHNOCARE : (made by GE TOSHIBA SILICONES)
- (FRW-17, FRW-1, FRV-100)

**Precautions when Mounting**

Do not apply force to the plastic part of the LED under high-temperature conditions. To avoid damaging the LED plastic, do not apply friction using a hard material. When installing the PCB in a product, ensure that the device does not come into contact with other components.

**Tape Specifications**

**1. Product number format**

The type of package used for shipment is denoted by a symbol suffix after the product number. The method of classification is as below. (this method, however does not apply to products whose electrical characteristics differ from standard Toshiba specifications)

- (1) Tape Type: T14 (4-mm pitch)
- (2) Example

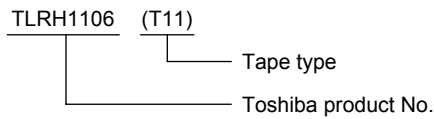

**2. Tape dimensions**

Unit: mm

Symbol	Dimension	Tolerance
D	1.5	+0.1/-0
E	1.75	±0.1
P <sub>0</sub>	4.0	±0.1
t	0.3	±0.05
F	3.5	±0.05
D <sub>1</sub>	1.5	±0.1

Symbol	Dimension	Tolerance
P <sub>2</sub>	2.0	±0.05
W	8.0	±0.3
P	4.0	±0.1
A <sub>0</sub>	2.9	±0.1
B <sub>0</sub>	3.7	±0.1
K <sub>0</sub>	2.3	±0.1

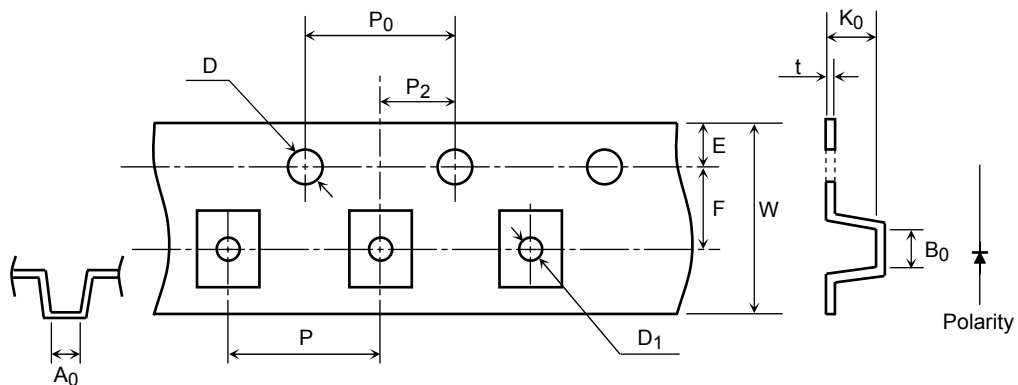

**3. Reel dimensions**

Unit: mm

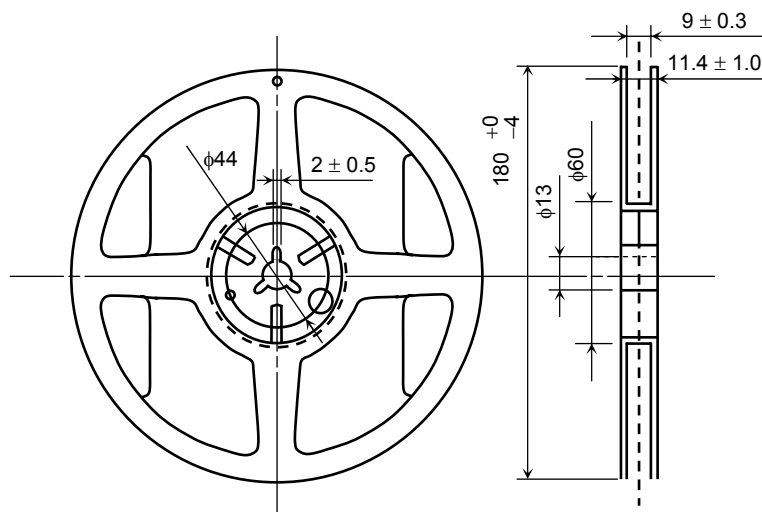

**4. Leader and trailer sections of tape**

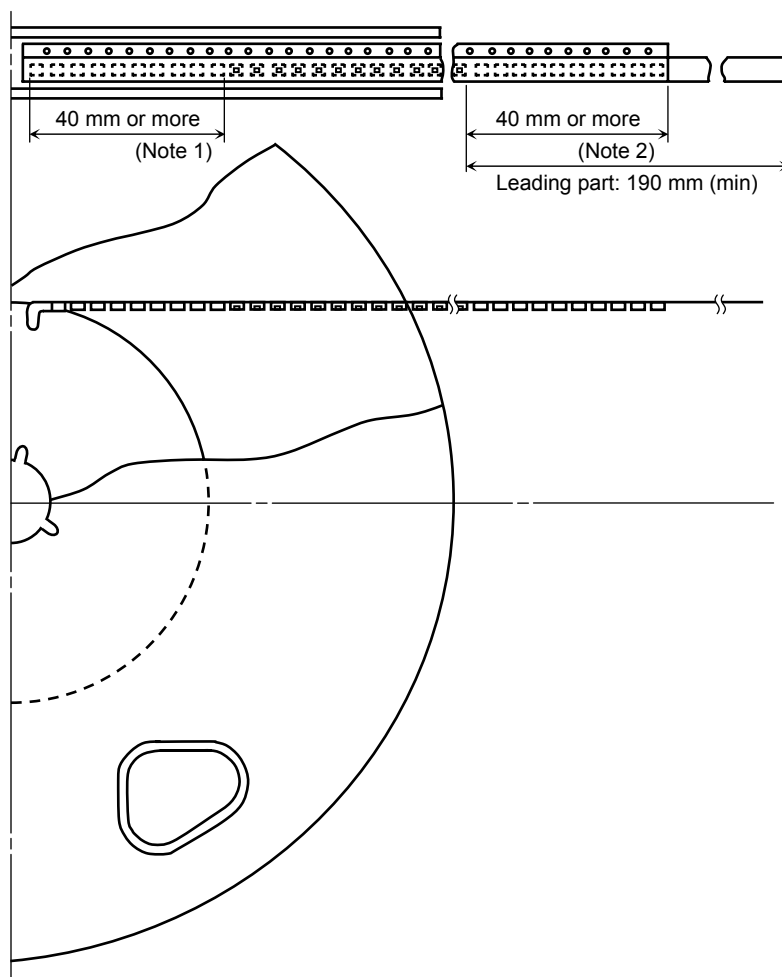

Note1: Empty trailer section

Note2: Empty leader section



**RESTRICTIONS ON PRODUCT USE**

- The information contained herein is subject to change without notice.
- TOSHIBA is continually working to improve the quality and reliability of its products. Nevertheless, semiconductor devices in general can malfunction or fail due to their inherent electrical sensitivity and vulnerability to physical stress. It is the responsibility of the buyer, when utilizing TOSHIBA products, to comply with the standards of safety in making a safe design for the entire system, and to avoid situations in which a malfunction or failure of such TOSHIBA products could cause loss of human life, bodily injury or damage to property.  
In developing your designs, please ensure that TOSHIBA products are used within specified operating ranges as set forth in the most recent TOSHIBA products specifications. Also, please keep in mind the precautions and conditions set forth in the "Handling Guide for Semiconductor Devices," or "TOSHIBA Semiconductor Reliability Handbook" etc.
- The TOSHIBA products listed in this document are intended for usage in general electronics applications (computer, personal equipment, office equipment, measuring equipment, industrial robotics, domestic appliances, etc.). These TOSHIBA products are neither intended nor warranted for usage in equipment that requires extraordinarily high quality and/or reliability or a malfunction or failure of which may cause loss of human life or bodily injury ("Unintended Usage"). Unintended Usage include atomic energy control instruments, airplane or spaceship instruments, transportation instruments, traffic signal instruments, combustion control instruments, medical instruments, all types of safety devices, etc. Unintended Usage of TOSHIBA products listed in this document shall be made at the customer's own risk.
- The products described in this document shall not be used or embedded to any downstream products of which manufacture, use and/or sale are prohibited under any applicable laws and regulations.
- GaAs(Gallium Arsenide) is used in this product. The dust or vapor is harmful to the human body. Do not break, cut, crush or dissolve chemically.
- The information contained herein is presented only as a guide for the applications of our products. No responsibility is assumed by TOSHIBA for any infringements of patents or other rights of the third parties which may result from its use. No license is granted by implication or otherwise under any patent or patent rights of TOSHIBA or others.