

FCI CONFIDENTIAL



This document is the property of and embodies CONFIDENTIAL and PROPRIETARY information of FCI. No part of the information shown on this document may be used in any way or disclosed to others without the written consent of FCI. Copyright FCI.

PRODUCT NO.	POSITION	REMARK	DIM "C"	DIM "D"
10053363-100LF	2X32	WITH KEY	54.61	54.46
10053363-200LF	2X32	WITHOUT KEY	N/A	N/A

NOTES:

- MATERIALS:  
HOUSING: HIGH TEMPERATURE THERMOPLASTIC, UL 94V-0 RATED, BLACK.  
TERMINAL: HIGH CONDUCTIVITY COPPER ALLOY.  
CONTACT AREA: 30u" GOLD OVER 50u" NICKEL UNDERPLATED.  
SOLDER TAIL: 100u" TIN OVER 50u" NICKEL UNDERPLATED.
- PRODUCT PERFORMANCE SPEC. PER GS-12-259.
- PACKAGE SPECIFICATION PER GS-14-937.
- PART NUMBER 10053363-X00LF MEETS EUROPEAN UNION DIRECTIVE AND OTHER COUNTRY REGULATIONS AS DESCRIBED IN GS-22-008. THE HOUSING WILL WITHSTAND EXPOSURE TO 260°C±5°C PEAK TEMPERATURE FOR 5 SECONDS IN A REFLOW SOLDER APPLICATION WITH A CIRCUIT BOARD.
- MANUFACTURER'S NAME, P/N AND DATE CODE TO APPEAR ON THIS SURFACE AS PER GS-24-007.

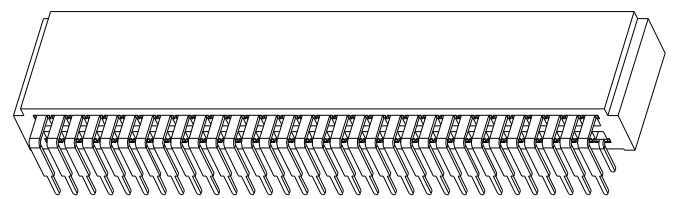
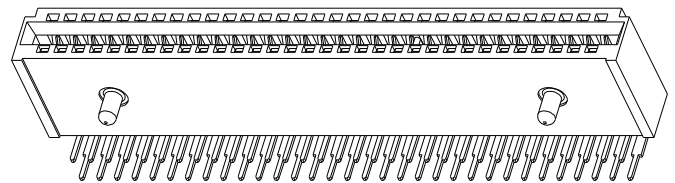

tolerance unless otherwise specified	
linear	.X ± .30 .XX ± .15 .XXX ± .08
angles	X° ± 2°

Mark with REV. in area indicated by X.....	Material		Spec ref		
	Mat code	Heatreat	✓	tolerance	projection
Plating/Finish		Dr		size	MM
rev	ecn no	dr	date	Eng	Product family
A	T05-0117	D T	05/31/05	DAVID TENG	05/26/05
B	T05-0130	D T	06/16/05	PAUL WANG	05/26/05
C	T05-0162	D T	08/10/05	JOSEPH HSIA	05/26/05
D	DG05-0287	SW	08/18/05	Model Name	
E	DG05-0521	SW	12/02/05	Model Revision	
F	DG06-0321	RYAN	08/07/06	REL Level	
G	DG06-0524	JULIA	12/26/06	REL Level	
FCI		title		POWER EDGE CARD CONNECTOR ASSY WITH STAND-OFF	
Pro/E file		catalog		dwg no	10053363
PDM: Rev:G		STATUS: Released		CUSTOMER	Rev. G
REV F: 2006-04-17		sheet 1 of 3		Printed: Mar 14, 2007	

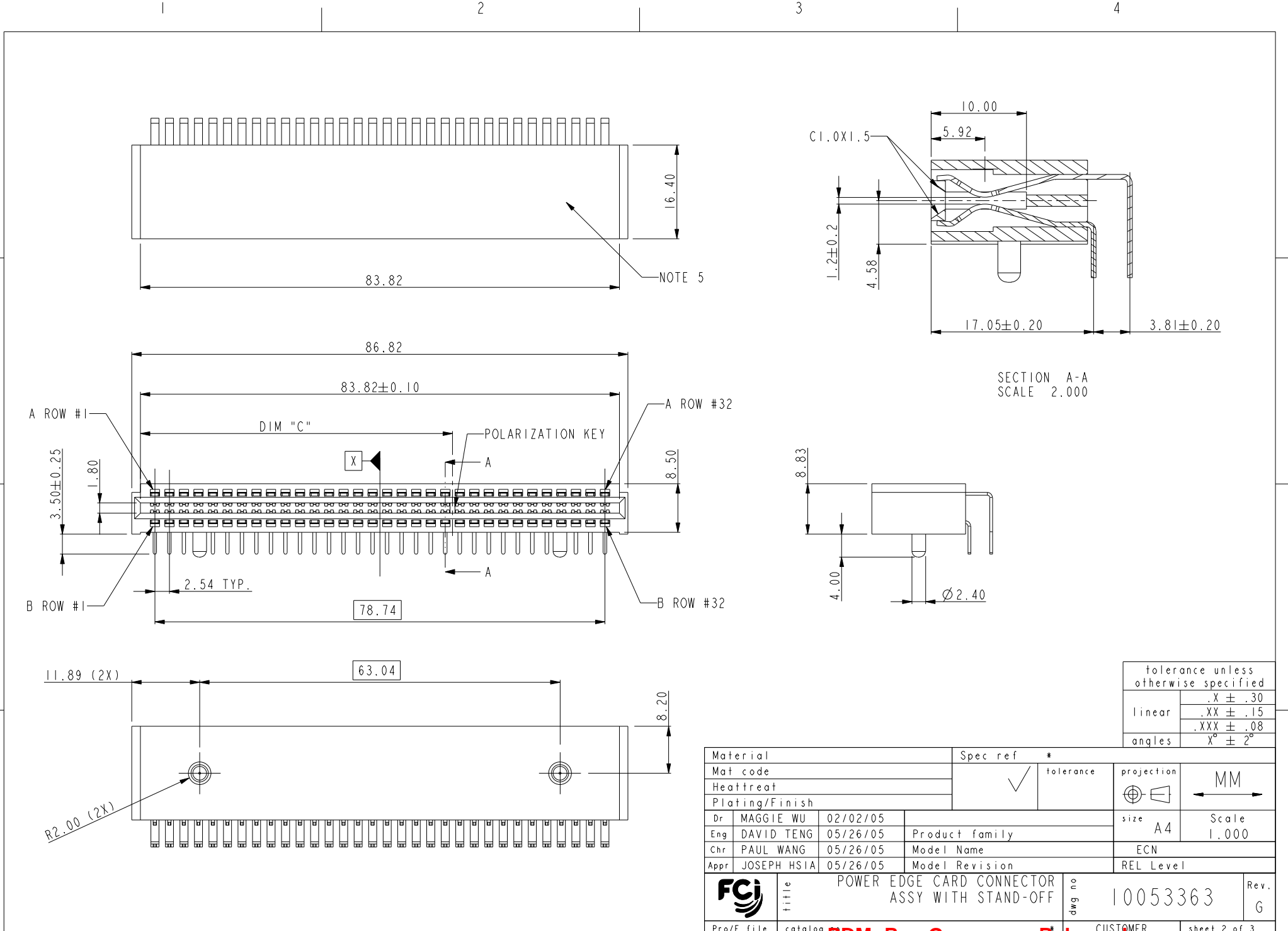

Material	Spec ref *			projection	MM
Mat code	✓	tolerance	projection	MM	
Heatreat				size	Scale
Plating/Finish				A4	1.000
Dr	MAGGIE WU	02/02/05		ECN	
Eng	DAVID TENG	05/26/05	Product family	REL Level	
Chr	PAUL WANG	05/26/05	Model Name		
Appr	JOSEPH HSIA	05/26/05	Model Revision		
FCI	title			dwg no	Rev.
Pro/E file	catalog	POWER EDGE CARD CONNECTOR ASSY WITH STAND-OFF		10053363	G

FCI CONFIDENTIAL



this document is the property of and embodies CONFIDENTIAL and PROPRIETARY information of FCI. No part of the information shown on this document may be used in any way or disclosed to others without the written consent of FCI. Copyright FCI.

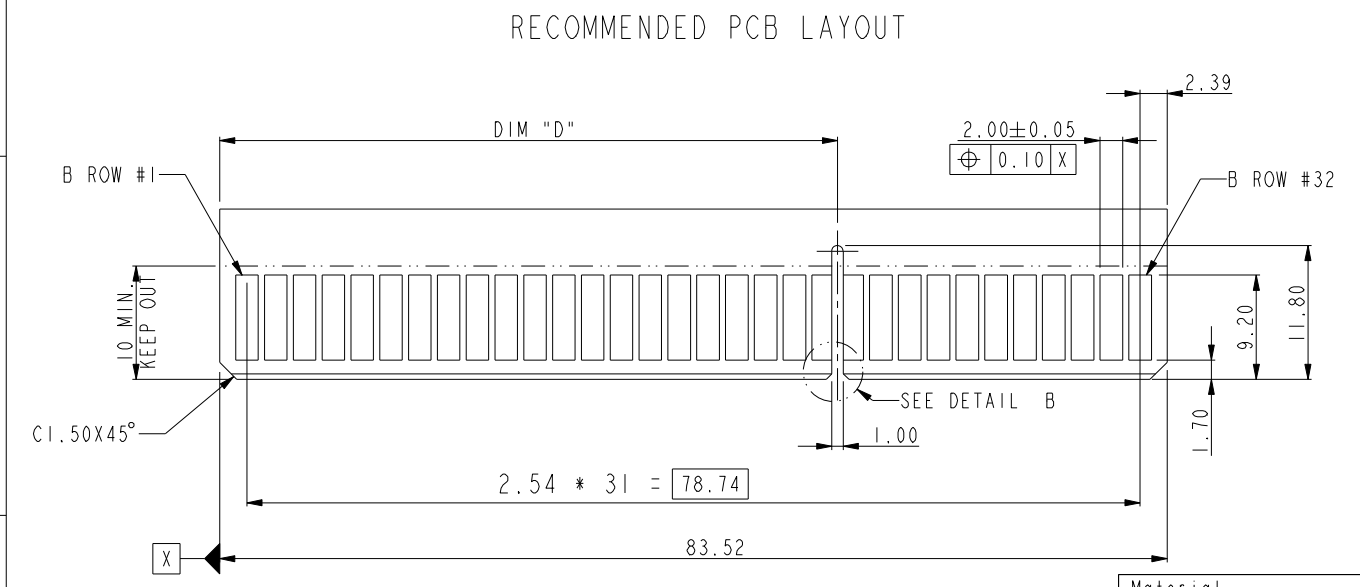
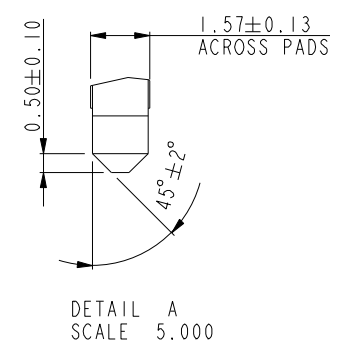
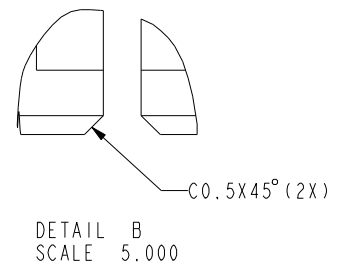
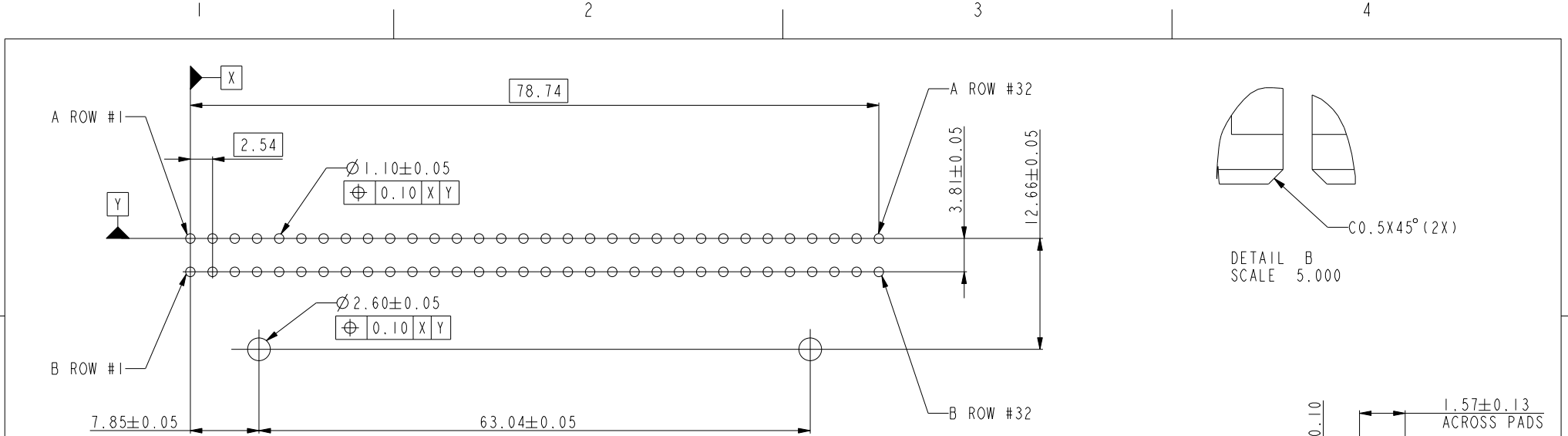

tolerance unless otherwise specified	
linear	.X ± .30
	.XX ± .15
	.XXX ± .08
angles	X° ± 2°

Material			Spec ref *	
Mat code			✓	tolerance
Heatreat			⊕	projection
Plating/Finish			←	MM
Dr	MAGGIE WU	02/02/05	size	A4
Eng	DAVID TENG	05/26/05	Product family	Scale 1.000
Chr	PAUL WANG	05/26/05	Model Name	ECN
Appr	JOSEPH HSIA	05/26/05	Model Revision	REL Level
FCI	title POWER EDGE CARD CONNECTOR ASSY WITH STAND-OFF		dwg no	10053363
Pro/E file	catalog	PDM- Rev:G	CUSTOMER	sheet 3 of 3