

Heatsink

Clip-on TO220 heatsink with cooling fins which form spring clamps that applies a constant pressure over entire contact surface of the TO220 case. Vertical mounting by solderable tags.

Product Features:

- Compact size
- Simple clip-on assembly
- Black anodize finish

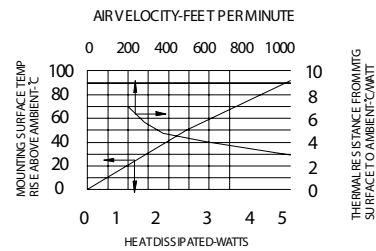
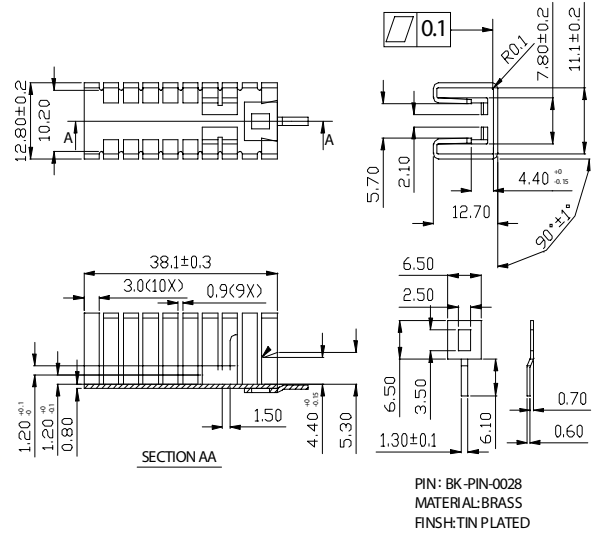

Ant Group No:	Thermal Resistance:	Height (mm):	Device Mtg:
HHS-1340	16.0°C/W	40	Clip-on