

Amphenol® 67 and 165 Series Miniaturized Standard Connectors

12-023-6



Amphenol

Table of Contents	Page No.
Amphenol® 67 Series “Minni E”	
General Information, Design Characteristics, Customer Options	1
Connector Applications, Mounting Dimensions	2, 3
Insert Arrangements	4
How to Order	5
Amphenol® 165 Series - Miniaturized MIL-C-5015	
General Information, Design Characteristics, Customer Options	6
Connector Applications	7
Insert Arrangements, Ordering Information	8
Sales Office Listing	

Amphenol® 67 Series “Minni E” environmental resistant cylindrical connectors

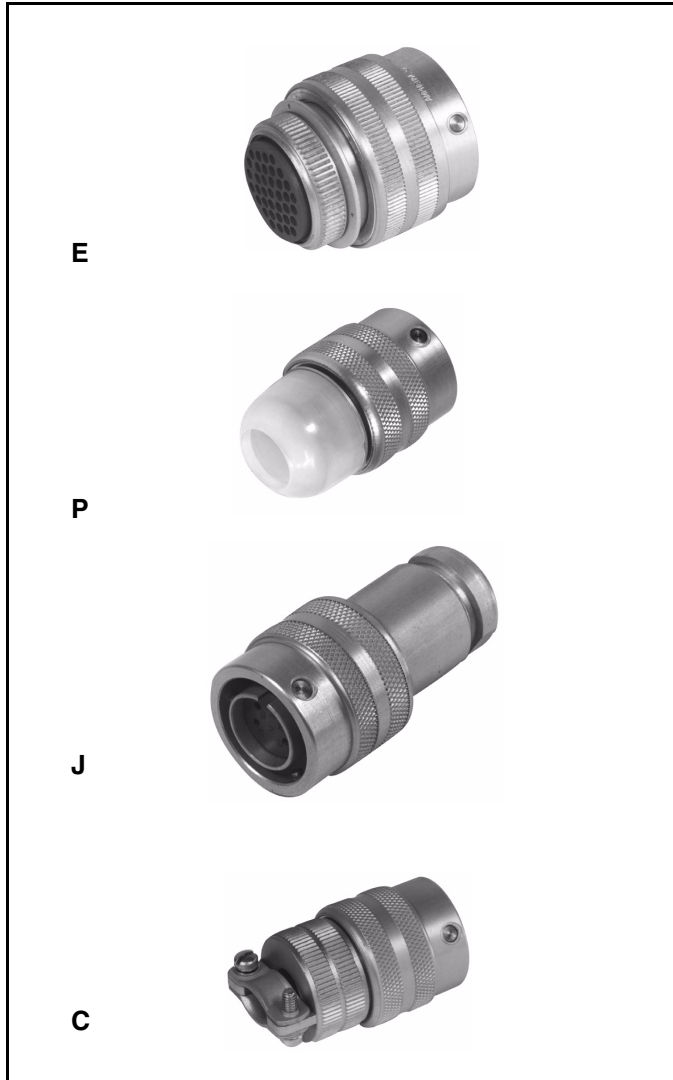

DESIGN CHARACTERISTICS

- Approximately half the weight of standard cylindricals
- Quick, positive, stainless steel bayonet coupling
- Operating temperatures from -67°F to +257°F per MIL-C-5015
- Sealed connectors capable of 1500 VRMS at 70,000 ft. altitude
- Vibration resistance of 10 to 2,000 cps at 20Gs
- Interfacial seal of neoprene rubber with individual contact barriers
- Moisture resistance exceeds MIL-C-5015 requirements with potting
- UL approved recognition file E115497

CUSTOMER OPTIONS

- Five shell styles
- Choice of unitized back end grommet or provision for potting
- Seventeen insert configurations
- Four construction classes available:
 - E - with unitized grommet for individual wire seal
 - P - includes potting mold
 - J - sealing clamp for jacketed cable
 - C - vise action with two-screw strain relief

Shell components are fabricated from high grade aluminum with gray anodize finish and stainless steel bayonet pins and slots. Contacts are copper alloy gold over nickel plate. Inserts are diallyl phthalate, providing high arc and insulation resistance under both humidity and thermal stress conditions. Positive locking action is provided by the spring-loaded coupling ring.

Amphenol® 67 Series connectors are ideal for applications that require a light to medium weight, durable, environmentally sealed connector.

For additional information on Amphenol® 67 Series connectors, or for special application requirements, contact your local sales office, authorized distributor, or

Amphenol Corporation
Amphenol Aerospace
40-60 Delaware Avenue
Sidney, New York 13838-1395
Phone: 607-563-5011
Fax: 607-563-5157
www.amphenol-aerospace.com

Voltage Rating

	Rating**	Mechanical Spacing (Nominal)	Flashover V-RMS*	Test V-RMS*	Recommended Working Voltage	
					DC	AC
Sea Level (unsealed)	A	.034	2,000	1,500	700	500
	B	.046	2,300	1,800	840	600
Sea Level (sealed)	A	.034	2,500	2,000	700	500
	B	.046	3,000	2,500	840	600
70,000 ft. (unsealed)	A	.034	500	375	175	125
	B	.046	600	450	210	150
70,000 ft. (sealed)	A	.034	2,500	1,500	700	500
	B	.046	3,000	1,800	840	600

* RATING - "B" rating is for insert 14-5 which takes a higher voltage; "A" rating is for other inserts.

** TYPICAL FLASHOVER VOLTAGES AT STANDARD CONDITIONS
(unsealed) Refers to connectors with no provisions for sealing front or rear areas.
(sealed) Refers to connectors that are potted or pressurized in mounting, with front and rear areas sealed.

Amphenol Aerospace is a certified ISO 9001 manufacturer.

67 Series

connector applications

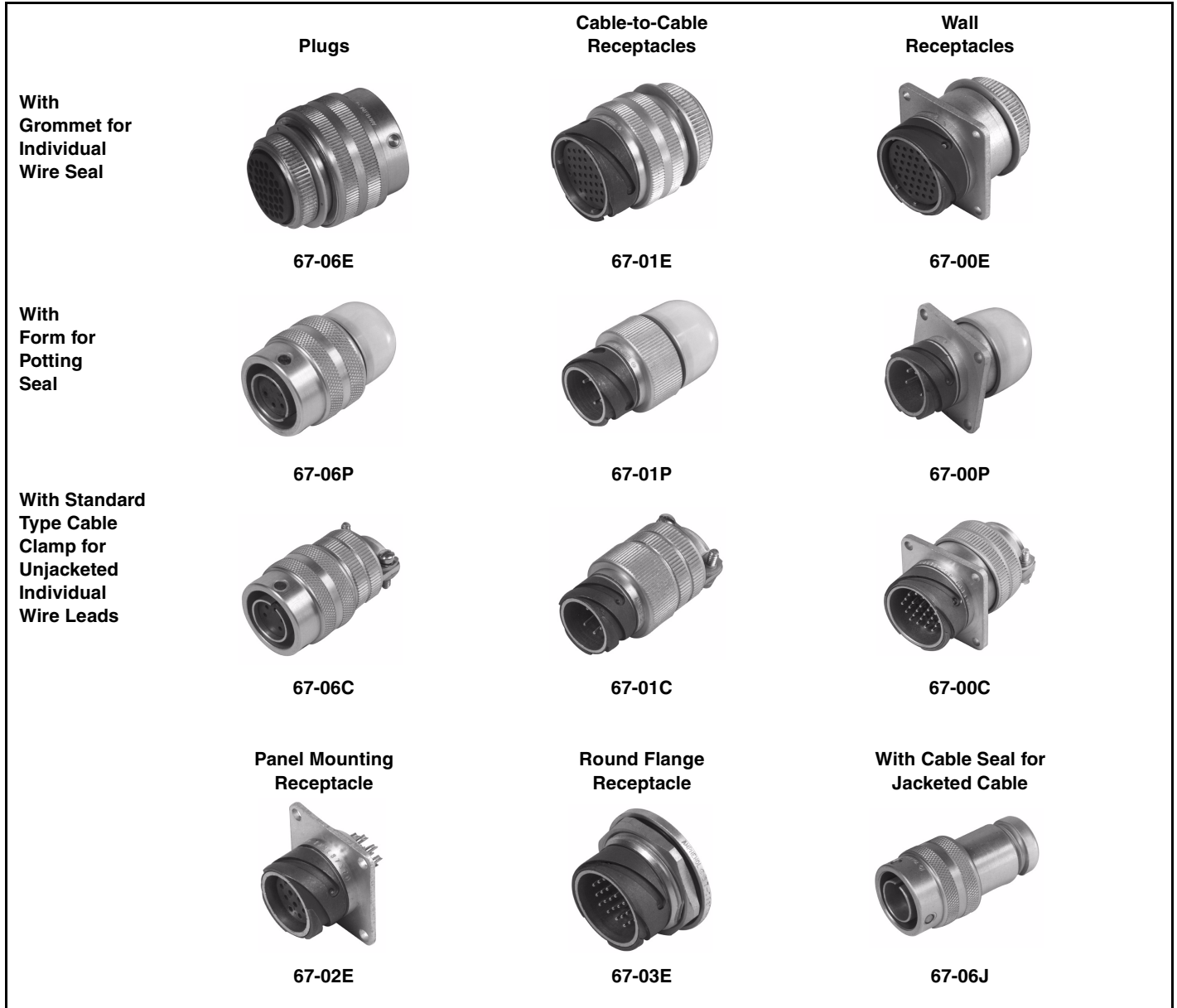

Mounting Dimensions

(For all 67 Series square flange connectors)

Connector Size	A	B	Suggested Mounting Hole
12	.812	1.031	.700
14	.906	1.125	.822
18	1.062	1.312	1.072
20	1.156	1.437	1.197
22	1.250	1.562	1.291

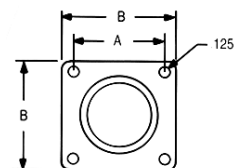

NOTE: All dimensions for reference only.

67 Series connector applications

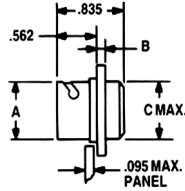

67-02E

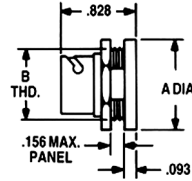

67-03E

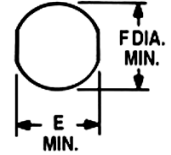

Suggested
Mounting Hole

Connector Size	A	B	C
12	.662	.062	.690
14	.781	.062	.812
18	1.032	.093	1.062
20	1.156	.093	1.187
22	1.281	.093	1.281

Connector Size	A	B	E	F
12	1.031	.750	.695	.755
14	1.156	.875	.820	.880
18	1.406	1.125	1.079	1.130
20	1.531	1.250	1.195	1.255
22	1.656	1.375	1.320	1.380

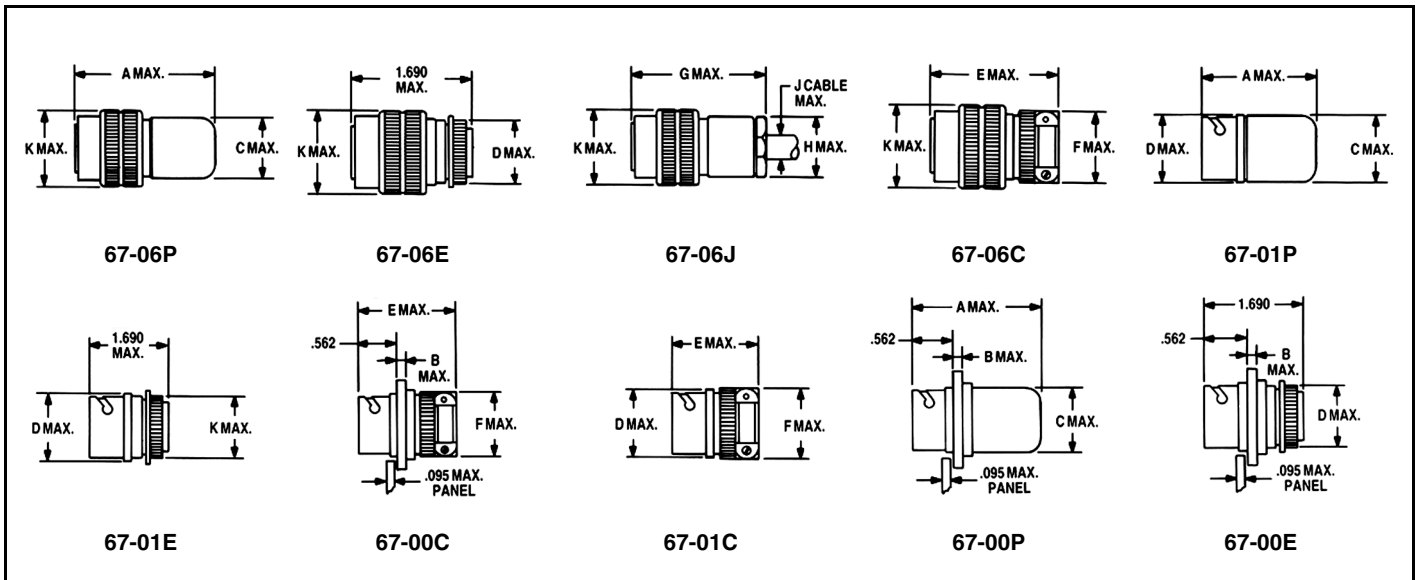

Connector Size	A	B	C	D	E	F	G	H	J	K
12	1.687	.093	.795	.895	1.870	.817	1.937	.706	.250	.957
14	1.687	.093	.920	1.000	1.870	.967	1.937	.812	.375	1.082
18	1.687	.093	1.170	1.250	1.870	1.185	1.937	1.062	.656	1.375
20	1.734	.093	1.223	1.375	1.970	1.312	2.312	1.187	.750	1.500
22	1.734	.093	1.352	1.468	1.970	1.440	2.312	1.317	.875	1.625

NOTE: All dimensions for reference only.

67 Series

insert arrangements

front face of insert illustrated

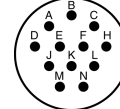
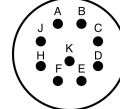
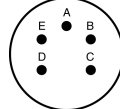
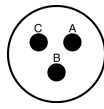
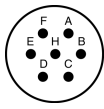

Insert Arrangement
Number of Contacts
Contact Size

12-7
7
20

12-60
3
16

14-5
5
20

14-9
9
20

14-12
12
20

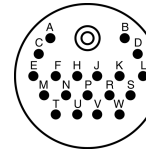
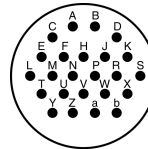
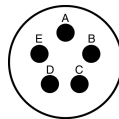
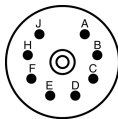

Insert Arrangement
Number of Contacts
Contact Size

14-61
8
20

14-63
5
16

18-24
24
20

18-62
19
20

plus 1 shielded contact

plus 1 shielded contact

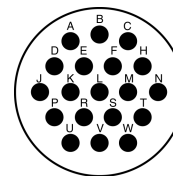
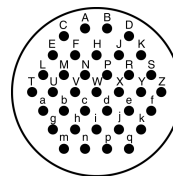
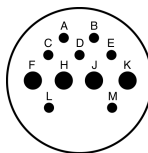
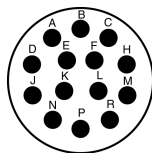

Insert Arrangement
Number of Contacts
Contact Size

18-64
14
16

18-65
7 4
20 16

20-37
37
20

20-66
19
16

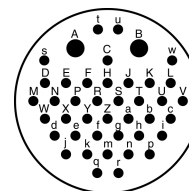
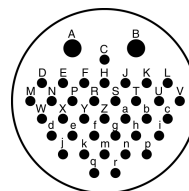
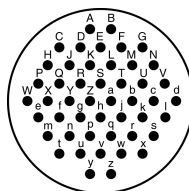
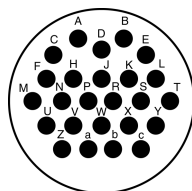

Insert Arrangement
Number of Contacts
Contact Size

22-67
25
16

22-48
48
20

22-68
36 2
20 16

22-69
40 2
20 16

Current rating - #20 contact: 7.5 amps, #16 contact: 12 amps
Shielded contact: 7.5 amps

Contact Legend

16 ●

20 ●

shielded ☉

67 Series

how to order

Amphenol® 67 Series “Minni E” Connectors can be ordered by coded part number. Ordering procedure is illustrated by part number 67-06E12-7PW-100 as shown below:

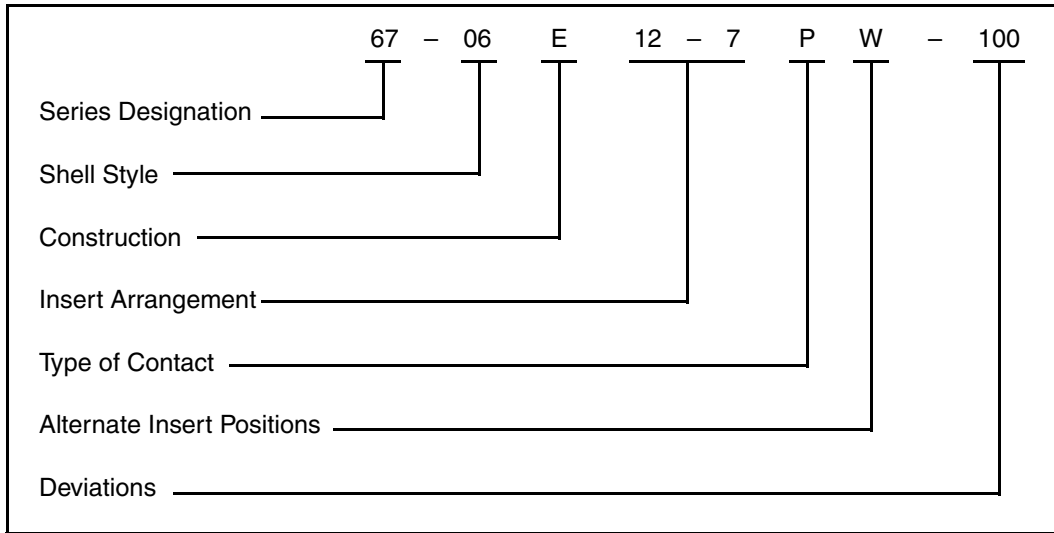

Series Designation

67 -

Shell Style

- 00 - Wall mounting receptacle
- 01 - Cable mounting receptacle
- 02 - Panel mount receptacle
- 03 - Rear panel mount, round flange receptacle
- 06 - Cable plug - straight

Construction

- E Environmentally sealed (Unitized grommet)
- P Environmentally sealed (Disposable polyethylene potting form furnished)
- J Sealing clamp for jacketed cable (Waterproof)
- C Mechanical Clamp (Sealed only when potted)

Insert Arrangement

See available insert arrangements, page 4

Type of Contact

- P - Pin
- S - Socket

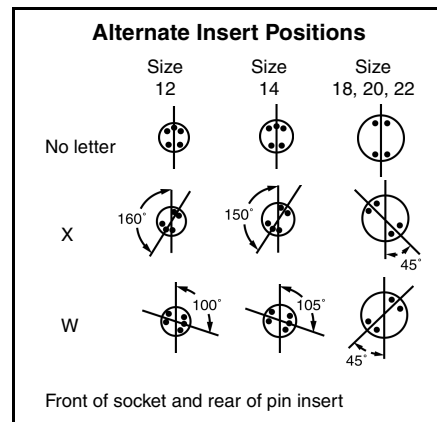

Deviations

- 100 - 100 μin. gold over silver contacts
- 106 - Pretinned solder wells
- 113 - Aluminum parts iridite finish

Amphenol® 165 Series miniaturized standard connectors

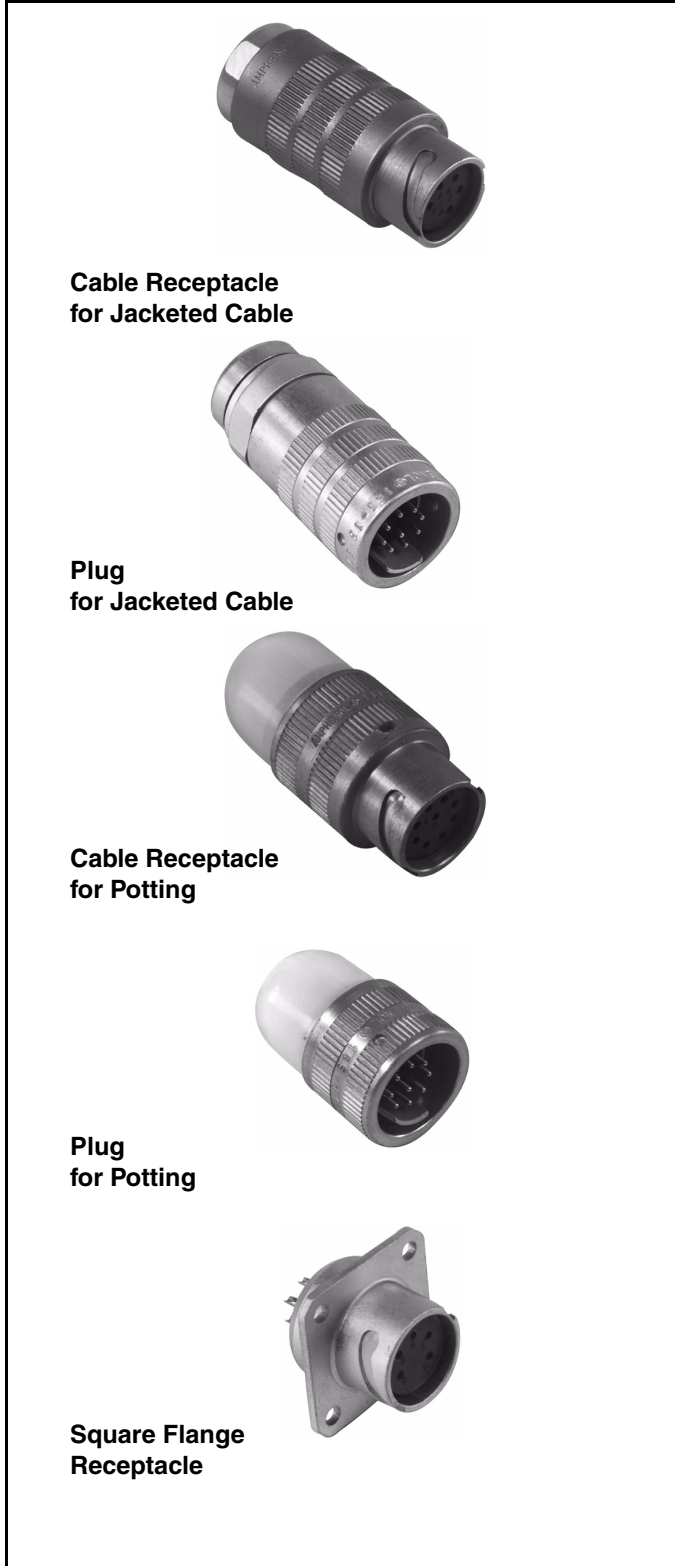

DESIGN CHARACTERISTICS

- Approximately one-third the size and weight of standard MIL-C-5015 connectors
- Quick, positive, bayonet coupling
- O-ring seals in both plugs and receptacles make connectors pressure proof and water protected when mated
- Meets pressure seal requirements of MIL-C-5015, Class C construction
- UL approved recognition file E115497

CUSTOMER OPTIONS

- Five shell styles in two sizes - large and small
- Seven insert configurations

Shell components are fabricated from high grade aluminum with gray anodize finish. Contacts are copper alloy gold over nickel plate. Inserts are diallyl phthalate, providing high arc and insulation resistance under both humidity and thermal stress conditions. Connectors using female inserts feature a sandwich construction with the insert spun into a cartridge. Connectors are factory sealed to prevent leakage.

Amphenol® 165 Series connectors are ideal for applications that demand a lightweight connector that meets MIL-C-5015 requirements.

For additional information on Amphenol® 165 Series connectors, or for special application requirements, contact your local sales office, authorized distributor, or

Amphenol Corporation
Amphenol Aerospace
40-60 Delaware Avenue
Sidney, New York 13838-1395
Phone: 607-563-5011
Fax: 607-563-5157

Connector Weights

Style	Weight (pounds)	
	Small	Large
Cable receptacle for potting	0.0415	0.0599
Cable receptacle	0.0600	0.0945
Panel receptacle	0.0264	0.0439
Plug	0.0659	0.0975
Plug for potting	0.0302	0.0490

Amphenol Aerospace is a certified ISO 9001 manufacturer.

165 Series connector applications

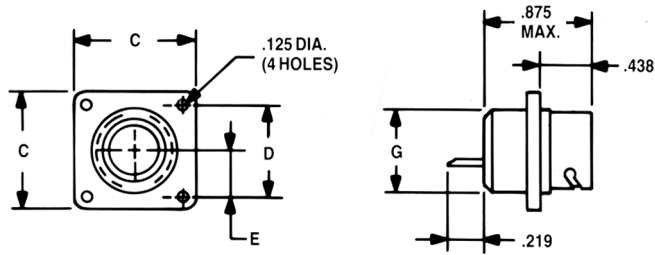

Panel Receptacle

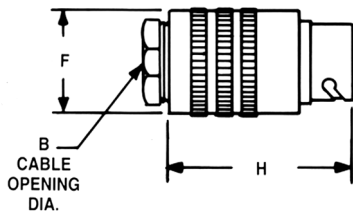

Cable Receptacle

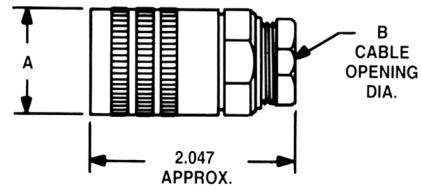

Cable Plug

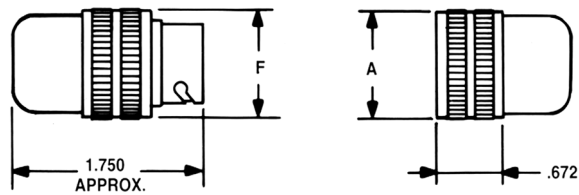

Potting Construction

	A	B	C	D	E	F	G	H
Small	.891	.375*	1.063	.781	.391	.875	.813	1.922
Large	1.141	.656	1.313	.969	.484	1.125	1.063	1.938

* 165-33 and 165-34 have cable opening of .281

NOTE: All dimensions for reference only

165 Series

insert arrangements, order information

front face of insert illustrated

The following chart provides ordering information. For example, to order a 165 Series plug with pin contacts use part number 165-33.

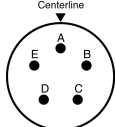
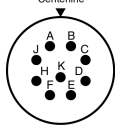
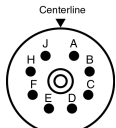
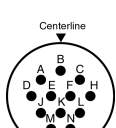
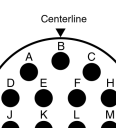
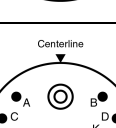
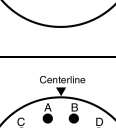
Insert Arrangements	Insert Style	Plug	Receptacle Sq. Flange	Cable Receptacle	Potting Constructions	
					Plug	Receptacle
 <p>5 #20 contacts Current Rating (Amperes) 7.5</p> <p>Voltage rating (Volts RMS at sea level) 600</p>	Pin	165-33	165-35	165-35-1002	165-33-1000	165-35-1000
	Socket	165-34	165-36	165-36-1003	165-34-1000	165-36-1000
 <p>9 #20 contacts Current Rating (Amperes) 7.5</p> <p>Voltage rating (Volts RMS at sea level) 500</p>	Pin	165-13	165-15	165-15-1002	165-13-1000	165-15-1000
	Socket	165-14	165-16	165-16-1003	165-14-1000	165-16-1000
 <p>8 #20 contacts, 1 Shielded contact Current Rating (Amperes) 10.0</p> <p>Voltage rating (Volts RMS at sea level) 500</p>	Pin	165-82	165-73	165-73-1001	165-82-1000	165-73-1000
	Socket	165-61-1008	165-83	165-83-1001	165-61	165-83-1000
 <p>12 #20 contacts Current Rating (Amperes) 7.5</p> <p>Voltage rating (Volts RMS at sea level) 500</p>	Pin	165-9	165-11	165-11-1002	165-9-1000	165-11-1000
	Socket	165-10	165-12	165-12-1002	165-10-1000	165-12-1000
 <p>14 #16 contacts Current Rating (Amperes) 17.0</p> <p>Voltage rating (Volts RMS at sea level) 500</p>	Pin	165-29	165-31	165-31-1003	165-29-1000	165-31-1000
	Socket	165-30	165-32	165-32-1006	165-30-1000	165-32-1000
 <p>19 #20 contacts, 1 Shielded contact Current Rating (Amperes) 10.0</p> <p>Voltage rating (Volts RMS at sea level) 500</p>	Pin	165-86	165-84	165-84-1001	165-86-1000	165-84-1000
	Socket	165-62-1007	165-85	165-85-1001	165-62	165-85-1000
 <p>24 #20 contacts Current Rating (Amperes) 7.5</p> <p>Voltage rating (Volts RMS at sea level) 500</p>	Pin	165-25	165-27	165-27-1005	165-25-1000	165-27-1000
	Socket	165-26	165-28	165-28-1003	165-26-1000	165-28-1000