

GENERAL TECHNICAL DATA

Specifications, Directives and Standards



The Camden products listed in this catalogue are developed and manufactured according to the rules set out in IEC international publications and EN European standard.

Specifications

- International Specifications
The International Electrotechnical Commission, IEC, which is part of the International Standards Organization, ISO, publishes IEC publications which act as a basis for the world market.
- European Specifications
The European Committee for Electrotechnical Standardisation (CENELEC), grouping 18 European countries, publishes EN standards for low voltage industrial apparatus.
These European standards differ very little from IEC international standards and use a similar numbering system. The same is true of national standards. Contradicting national standards are withdrawn.
- Harmonised European Specifications
The European Committees for Standardisation (CEN and CENELEC), grouping 18 European countries, publish EN standards relating to safety of machinery.
- Specifications in Canada and the USA
These are equivalent, but differ markedly from IEC, UTE, VDE and BS specifications.
UL Underwriters Laboratories (USA)
CSA Canadian Standards Association (Canada)

Remark concerning the label issued by the UL (USA). Two levels of acceptance between devices must be distinguished.

“Recognized” Authorised to be included in equipment, if the equipment in question has been entirely mounted and wired by qualified personnel. They are not valid for use as “General purpose products” as their possibilities are limited.

They bear the mark: 

“Listed” Authorised to be included in equipment and for separate sale are “General purpose products” components in the USA.

They bear the mark: 

European Directives

The guarantee of free movement of goods within the European Community assumes elimination of any regulatory differences between the member states. European Directives set up common rules that are included in the legislation of each state while contradictory regulations are cancelled.

There are three main directives:

- Low Voltage Directive 73/23/EEC, amended by Directive 93/68/EEC concerning electrical equipment from 50 to 1000 V a.c. and from 75 to 1500 V d.c.
This specifies that compliance with the requirements that it sets out is acquired once the equipment conforms to the standards harmonised at European level: EN 60947-1 and EN-60947-5-1 for circuit breakers.
- Machines Directives - 89/392/EEC, 91/368/EEC, 93/44/EEC, 93/68/EEC - defining main safety and health requirements concerning design and manufacture of the machines and other equipment including safety components in European Union countries.
- Electromagnetic Compatibility Directive 89/336/EEC, amended by Directive 92/31/EEC and Directive 93/68/EEC concerning all electrical devices likely to create electromagnetic disturbances.

Signification of CE marking:

CE marking must not be confused with a quality label.

CE marking placed on a product is proof of conformity with the European Directives concerning the product.

CE marking is part of an administrative procedure and guarantees free movement of the product within the European Community.

Standards

- International Standards
 - IEC 947-1 Low-voltage switchgear and controlgear - Part 1: General Rules (CEI EN 60947-1).
 - IEC 947-5-1 Low-voltage switchgear and controlgear - Part 5: Control circuit devices and switching elements - Section 1: Electromechanical control circuit devices (CEI EN 60947-5-1) - Chapter 3: Special requirements for control switches with positive opening operation.
 - IEC 204-1 Electrical equipment on industrial machines - Part 1: General requirements (CEI EN 60204-1).
 - IEC 204-2 Electrical equipment on industrial machines - Part 2: Item designation and examples of drawings, diagrams, tables and instructions
 - IEC 529 Degrees of protection provided by enclosure (IP code) (CEI EN 60529).

• European Standards

EN 50005	Low-voltage switchgear and controlgear for industrial use - Terminal marking and distinctive number: General rules (CEI 17-17).
EN 50013	Low-voltage switchgear and controlgear for industrial use - Terminal marking and distinctive number for particular control switches (CEI 17-17).
EN 50041	Low-voltage switchgear and controlgear for industrial use - Control switches - Position switches 42,5 x 80 - Dimensions and characteristics.
EN 50047	Low-voltage switchgear and controlgear for industrial use - Control switches - Position switches 30 x 55 - Dimensions and characteristics.
EN 60947-1	Low-voltage switchgear and controlgear for industrial use - Part 1: General rules (CEI EN 60947-1).
EN 60947-5-1	Low-voltage switchgear and controlgear for industrial use - Part 5: Control circuit devices and switching elements - Section 1: Electromechanical control circuit devices (CEI EN 60947-5-1) - Chapter 3: Special requirements for control switches with positive opening operation.
EN 60529	Degrees of protection provided by enclosures (IP code).
EN 61058-1	Switches for appliances. Part. 1: general requirements.

• Harmonised European Standards

These standards are common to all European Union and EFTA (European Free Trade Association) countries. They were prepared (prEN project) and written (EN final text) by the European standardisation committees CEN or CENELEC. Harmonised European standards were drawn up to allow definition of the rules and technical means to be used to satisfy the main safety requirements on machines and thus guarantee conformity with the Machines Directive. Compliance with a harmonised European standard is presumption of conformity with the relevant Directive. European standards relating to machine safety are divided into groups (A, B and C types).

Type A standards:	basic standards: setting out design principles and the general aspects valid for all machine types.
EN 292-1	Safety of machinery - Basic concepts, general principles for design - Part 1: Basic terminology, methodology.
EN 262-2 and EN 292-2/A1	Safety of machinery - Basic concepts, general principles for design - Part 2: Technical principles and specifications.
EN 1050	Safety of machinery - Principles for risk assessment.

Type B standards: group standards:

B1: dealing with specific safety aspects.

EN 60204-1 Safety of machinery - Electrical equipment of machines - Part 1: General requirements.

EN 954-1 Safety of machinery - Safety-related parts of control systems - Part 1: General principles for design.

B2: dealing with components and devices determining safety.

EN 1088 Safety of machinery - Interlocking devices associated with guards - Principles for design and selection

Type C standards: specific standards or standards per machine family giving detailed safety specifications applicable to a machine or to a group of machines

EN 81-1 Safety rules for the construction and installation of lifts - Part 1: Electric lifts.

• American Standards

UL 508	Standard for safety. Industrial control equipment.
CSA - C22.2 No. 14-95	Industrial control equipment. Industrial products.

LIMIT SWITCHES

Plastic or Metal Casing

Terminology

Double Insulation

Class II materials, according to IEC 536, are designed with double insulation. This measure consists in doubling the functional insulation with an additional layer of insulation so as to eliminate the risk of electric shock and thus not having to protect elsewhere. No conductive part of "double insulated" material should be connected to a protective conductor.

Positive Opening Operation

A control switch, with one or more break-contact elements, has a positive opening operation when the switch actuator ensures full contact opening of the break-contact. For the part of travel that separates the contacts, there must be a positive drive, with no resilient member (e.g. springs), between the moving contacts and the point of the actuator to which the actuating force is applied.

The positive opening operation does not deal with N.O. contacts.

Control switches with positive opening operation may be provided with either snap action or slow action contact elements. To use several contacts on the same control switch with positive opening operation, they must be electrically separated from each other, if not, only one may be used.

Every control switch with positive opening operation must be indelibly marked on the outside with the symbol: .

Snap Action

Snap action contacts are characterised by a release position that is distinct from the operating position (differential travel). Snap breaking of moving contacts is independent of the switch actuator's speed and contributes to regular electric performance even for slow switch actuator speeds

Slow Action

Slow action contacts are characterised by a release position that is the same as the operating position. The switch actuator's speed directly conditions the travel speed of contacts.

Contact shape according to IEC 947-5-1.

Change-over contact elements with 4 terminals must be indelibly marked with the corresponding Za or Zb symbol as in the diagrams below.



Contacts with the same polarity

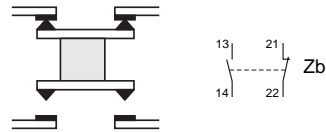

The 2 moving contacts are electrically separated

Utilization Category

AC-15: switching of electromagnetic loads of electromagnets using an alternating current (>72 VA).

DC-13: switching of electromagnets using a direct current.

Terminals

Limit switches with metal casings must have a terminal, for a protective conductor, that is placed inside the casing very close to the cable inlet and must be indelibly marked.

Minimum Actuation Force/Torque

The minimum amount of force/torque that is to be applied to the switch actuator to produce a change in contact position.

Minimum Force/Torque to achieve Positive Opening Operation

The minimum amount of force/torque that is to be applied to the switch actuator to ensure positive opening operation of the N.C. contact.

LIMIT SWITCHES

Plastic or Metal Casing

Travel and Operation Diagrams

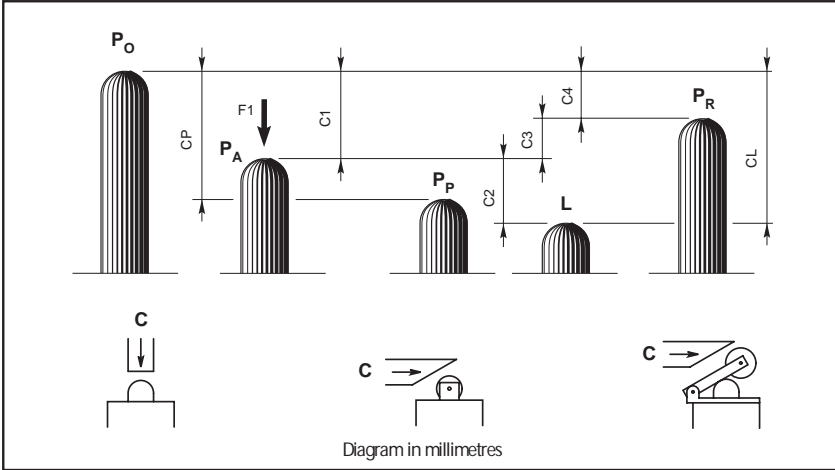

P₀ Free position:

position of the switch actuator when no external force is exerted on it.

P_A Operating position:

position of the switch actuator, under the effect of force F1, when the contacts leave their initial free position.

P_P Positive opening position:

position of the switch actuator from which positive opening is ensured.

L Max. travel position:

maximum acceptable travel position of the switch actuator under the effect of a force F1.

P_R Release position:

position of the switch actuator when the contacts return to their initial free position.

C₁ Pre-travel:

distance between the free position P₀ and the operating position P_A

C_P Positive opening travel:

minimum travel of the switch actuator, from the free position, to ensure positive opening operation of the normally closed contact.

C₂ Over-travel:

distance between the operating position P_A and the max. travel position L.

C_L Max. travel:

distance between the free position P₀ and the max. travel position L.

C₃ Differential travel (C1-C4):

travel difference of the switch actuator between the operating position P_A and the release position P_R.

C₄ Release travel:

distance between the release position P_R and the free position P₀.

Diagram for snap action contacts:

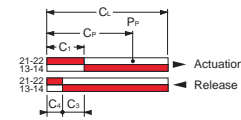
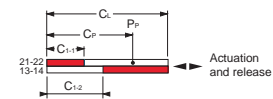

Diagram for non-overlapping slow action contacts:



Note: for slow action contacts, C₃ = 0, C₁₋₁ = pre-travel of contact 21-22, C₁₋₂ = pre-travel of contact 13-14

LIMIT SWITCHES

Plastic or Metal Casing

Travel and Operation Diagrams

SUMMARY LIMIT SWITCHES

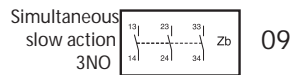
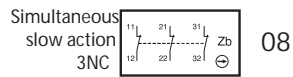
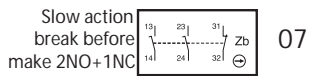
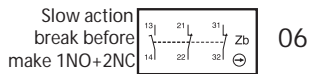
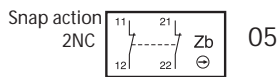
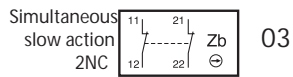
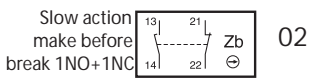
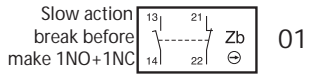
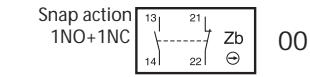

CE10...P



CE10...M



CE20...P



CE21...M



CE41...P



CE41...M



CE31...M



CE10 SERIES LIMIT SWITCHES

Metal Casing IP66 - 30 mm. width

Description



General Technical Data

Standards		Metal Casing
Certifications - Approvals		Devices conform with international IEC 947-5-1 and European EN 60 947-5-1 standards
Air temperature near the device – during operation	°C	UL - CSA - IMO - 25 ... + 70
Climatic withstand		According to IEC 68-2-3 and salty mist according to IEC 68-2-11
Mounting positions		All positions
Shock withstand (according to IEC 68-2-27 and EN 60 068-2-27)		50g* (1/2 sinusoidal shock for 11 ms) no change in contact position
Resistance to vibrations (acc. to IEC 68-2-6 and EN 60 068-2-6)		25g (10 ... 500 Hz) no change in position of contacts greater than 100 µs
Protection against electrical shocks (acc to EIC 536)		Class I
Degree of protection (according to IEC 529 and EN 60 529)		IP 66
Consistency (measured over 1 million operations)		0.1 mm (upon closing point)
Minimum actuation speed	m/s	Slow action contacts 0.060 / Snap action contacts 0.001

Electrical Data

Rated insulation voltage Ui			500 V (degree of pollution 3)
- according to IEC 947-1 and EN 60-947-1			A600, Q600 (A300, Q300 for CE10_M & CE21_M Series)
- according to UL 508 and CSA C22-2 n° 14			
Rated impulse withstand voltage U _{imp} (according to IEC 947-1 and EN 60 947-1)	kV		6
Conventional free air thermal current I _{th} (according to IEC 947-5-1) θ < 40 °C	A		10
Short-circuit protection U _e < 500 V a.c. - gG (gl) type fuses	A		10
Rated operational current I _e / AC-15 (according to IEC 947-5-1)			
	24 V - 50/60 Hz	A	10
	120 V - 50/60 Hz	A	6
	230 V - 50/60 Hz	A	3.1
	240 V - 50/60 Hz	A	3
	400 V - 50/60 Hz	A	1.8
I _e / DC-13 (according to IEC 947-5-1)			
	24 V - d.c.	A	2.8
	125 V - d.c.	A	0.55
	250 V - d.c.	A	0.27
Switching frequency	Cycles/h		3600
Load factor			0.5
Resistance between contacts	mΩ		25

* 25g for EP/50, FP/50, FP/50/T, FRP/50 & FRP50/T

IMQ listed values

CE10 SERIES LIMIT SWITCHES

Metal Casing IP66 - 30 mm. width



EM_ Nylon Roller Lever

(For Metal Rollerr add/T43 to end of part number)

Operating Head

Conformity / (N.C. contact with positive opening operation): EN 50047

Max actuation speed [m/s]: 1.5

Min. force [N] or torque [Nm]: actuation / positive opening operation: 0.10/0.30

Weight (kg): 0.235

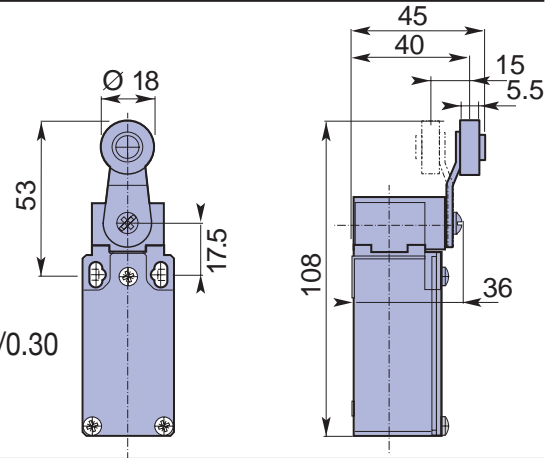

Part Number	Contact Block	Type	Travel Diagram
CE10.00.EM	Snap Action Contacts (1NO + 1NC)	00	
CE10.01.EM	Non overlapping Slow Action Contacts (1NO + 1NC)	01	
CE10.02.EM	Overlapping Slow Action Contacts (1NO + 1NC)	02	
CE10.03.EM	Slow Action Contacts (2NC)	03	
CE10.04.EM	Slow Action Contacts (2NO)	04	
CE10.05.EM	Snap Action Contacts (2NC)	05	