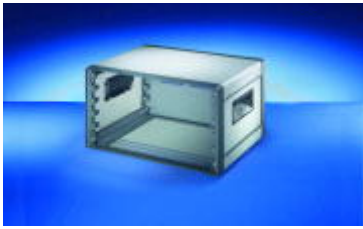
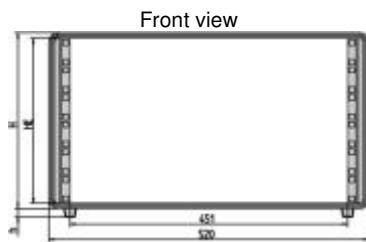

comptec 6-9 U

[Print page](#)**Article number: 10225-604**

- With handle shell
- Cover, base and rear panel made out of steel

Delivery quantity: kit

h = case foot height, HE = U, internal usable height

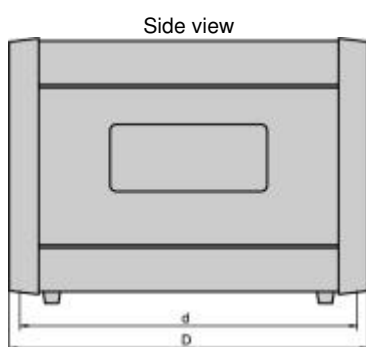
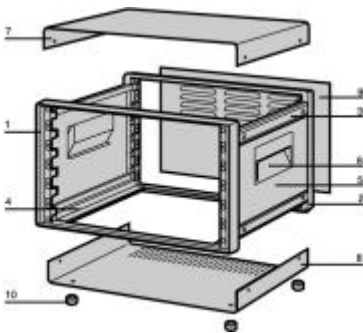

Usable depth $d = D - 24$ mm

Item	Qty	Description
1	1	Front frame, Al die-cast , RAL 7016, with 19" mounting
2	1	Rear frame, Al die-cast, RAL 7016, with 19" mounting
3	2	Side profile at top, Al extrusion, RAL 7016
4	2	Side profile at bottom, Al extrusion, RAL 7016
5	2	Side panel, St, 1.5 mm, RAL 9006, with GND/earthing tag
6	2	Handle shell, PC, RAL 7016, UL 94 V-0
7	1	Cover, St, 1 mm, RAL 9006, with GND/earthing tag
8	1	base, St, 1 mm, RAL 9006, with GND/earthing tag
9	1	Rear panel, St, 1 mm, RAL 9006, with GND/earthing tag
10	4	Case foot with anti-slip protection, PC, black, UL 94 V-0
11	1	Assembly kit

Technical data:

Height	Height H	h	Depth D	Usable depth d
6 U	286 mm	13 mm	300 mm	276 mm

Further Information:

User Manual