

Features

- (For $V^+=5V$ and $V^-=0V$ typical unless otherwise noted)
- Guaranteed 2.7V and 5V performance
 - Crossover distortion eliminated
 - Operating temperature range (-40°C to +85°C)
 - Gain-bandwidth product 1 MHz
 - Low supply current
 - LMV321 110 μA Typ
 - LMV358 190 μA Typ
 - LMV324 340 μA Typ
 - Rail-to-rail output swing @ 10 k Ω
 - V^+ -10 mV
 - V^- +10 mV
 - Input Common Mode Voltage Range (-0.2 to $V^+-0.8V$)
 - Manufactured in standard CMOS process
 - SOT353, SOT25, MSOP-8L, SOP-8L and TSSOP-14L:
Available in "Green" Molding Compound (No Br, Sb)
 - Lead-free Finish/ RoHS Compliant (Note 4)

General Description

The LMV321/LMV358/LMV324 are low voltage (2.7V to 5.5V) single, dual and quad operational amplifiers. The LMV321/LMV358/LMV324 are designed to effectively reduce cost and space at low voltage levels. These devices have the capability of rail-to-rail output swing and input common-mode voltage range includes ground. They can also achieve an efficient speed-to-power ratio, utilizing 1 MHz bandwidth and 1 V/ μs slew rate at a low supply current. Reducing noise pickup and increasing signal integrity can be achieved by placing the device close to the signal source. The LMV321 is available in 5-Pin SOT353/SOT25 packages that reduce space on pc boards and portable electronic devices. The LMV324 is available in the TSSOP-14L package. The LMV358 is available in the MSOP-8L and SOP-8L packages.

Applications

- Active filters
- General purpose low voltage applications
- General purpose portable devices

Ordering Information

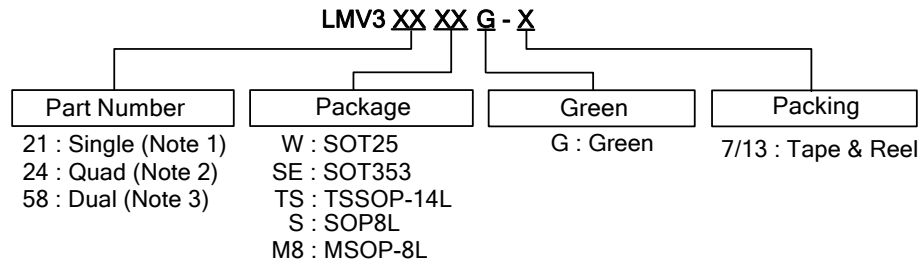

Device	Package Code	Packaging (Note 5)	7"/13" Tape and Reel	
			Quantity	Part Number Suffix
LMV321WG-7	W	SOT25	3000/Tape & Reel	-7
LMV321SEG-7	SE	SOT353	3000/Tape & Reel	-7
LMV324TSG-13	TS	TSSOP-14L	2500/Tape & Reel	-13
LMV358SG-13	S	SOP-8L	2500/Tape & Reel	-13
LMV358M8G-13	M8	MSOP-8L	2500/Tape & Reel	-13

- Notes:
1. LMV321 is only available for SOT25 and SOT353.
 2. LMV324 is only available for TSSOP-14L.
 3. LMV358 is only available for SOP-8L and MSOP-8L.
 4. EU Directive 2002/95/EC (RoHS). All applicable RoHS exemptions applied. Please visit our website at http://www.diodes.com/products/lead_free.html
 5. Pad layout as shown on Diodes Inc. suggested pad layout document AP02001, which can be found on our website at <http://www.diodes.com/datasheets/ap02001.pdf>.

Pin Assignments

(1) SOT25 / SOT353

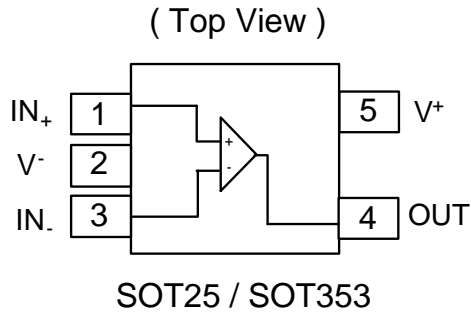

(2) SOP-8L / MSOP-8L

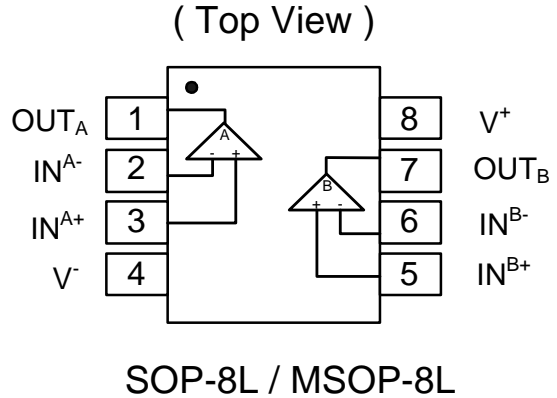

(3) TSSOP-14L

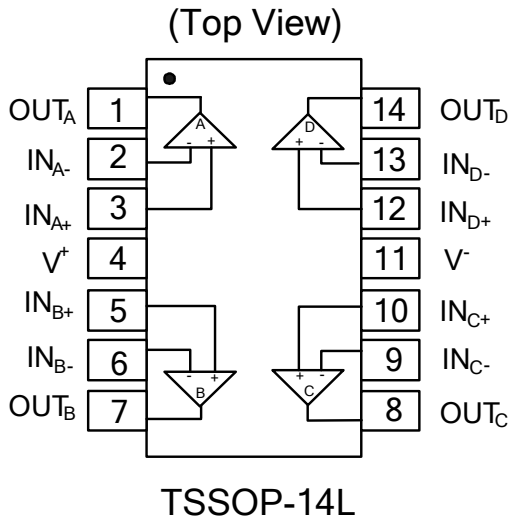

Absolute Maximum Ratings (Note 6)

Symbol	Description	Rating	Unit	
ESD HBM	Human Body Model ESD Protection	LMV321	4.0	KV
		LMV358	4.0	
		LMV324	4.5	
ESD MM	Machine Model ESD Protection	LMV321	350	V
		LMV358	350	
		LMV324	250	
	Differential Input Voltage	\pm Supply Voltage	V	
$V^+ - V^-$	Supply Voltage	5.5	V	
	Output Short Circuit to V^+	(Note 7)		
	Output Short Circuit to V^-	(Note 8)		
T_{ST}	Storage Temperature	-65 to 150	$^{\circ}$ C	
T_J	Maximum Junction Temperature	150	$^{\circ}$ C	

Operating Ratings (Note 6)

Symbol	Description	Rating	Unit
$V^+ - V^-$	Supply Voltage	2.7 to 5.5	V
T_A	Operating Ambient Temperature Range	-40 to +85	$^{\circ}$ C

Notes: 6. Absolute Maximum Ratings indicate limits beyond which damage to the device may occur. Operating Ratings indicate conditions for which the device is intended to be functional, but specific performance is not guaranteed. For guaranteed specifications and the test conditions, see the Electrical Characteristics.

Electrical Characteristics

2.7V DC Electrical Characteristics

Unless otherwise specified, all limits guaranteed for $T_A = 25^\circ\text{C}$, $V^+ = 2.7\text{V}$, $V^- = 0\text{V}$, $V_{CM} = 1.0\text{V}$, $V_O = V^+/2$ and $R_L > 1\text{M}\Omega$.

Symbol	Parameter	Test Conditions	Min (Note 10)	Typ. (Note 9)	Max (Note 10)	Unit
V_{OS}	Input Offset Voltage			1.7	7	mV
TCV_{OS}	Input Offset Voltage Average Drift			5		$\mu\text{V}/^\circ\text{C}$
I_B	Input Bias Current			10		nA
I_{OS}	Input Offset Current			5	50	nA
CMRR	Common Mode Rejection Ratio	$0\text{V} \leq V_{CM} \leq 1.7\text{V}$	50	63		dB
PSRR	Power Supply Rejection Ratio	$2.7\text{V} \leq V^+ \leq 5\text{V}$ $V_O = 1\text{V}$	50	60		dB
V_{CMR}	Input Common-Mode Voltage Range	For CMRR $\geq 50\text{dB}$	0	-0.2 1.9	1.7	V
V_O	Output Swing	$R_L = 10\text{ k}\Omega$ to 1.35V	$V^+ - 100$	$V^+ - 20$ 20	100	mV
I_S	Supply Current	LMV321 Single amplifier		110	140	μA
		LMV358 Both amplifiers		190	340	μA
		LMV324 All four amplifiers		340	680	μA

2.7V AC Electrical Characteristics

Unless otherwise specified, all limits guaranteed for $T_A = 25^\circ\text{C}$, $V^+ = 2.7\text{V}$, $V^- = 0\text{V}$, $V_{CM} = 1.0\text{V}$, $V_O = V^+/2$ and $R_L > 1\text{M}\Omega$.

Symbol	Parameter	Test Conditions	Min (Note 10)	Typ. (Note 9)	Max (Note 10)	Unit
GBWP	Gain-Bandwidth Product	$C_L = 200\text{ pF}$		1		MHz
ϕ_m	Phase Margin			60		Deg
Gm	Gain Margin			10		dB
e_n	Input-Referred Voltage Noise	$f > 50\text{ kHz}$		23		$\frac{\text{nV}}{\sqrt{\text{Hz}}}$

Electrical Characteristics (Continued)

5V DC Electrical Characteristics

Unless otherwise specified, all limits guaranteed for $T_A = 25^\circ\text{C}$, $V^+ = 5\text{V}$, $V^- = 0\text{V}$, $V_{\text{CM}} = 2.0\text{V}$, $V_O = V^+/2$ and $R_L > 1\text{M}\Omega$. **Boldface** limits apply at the temperature extremes.

Symbol	Parameter	Test Conditions	Min (Note 10)	Typ. (Note 9)	Max (Note 10)	Unit
V_{OS}	Input Offset Voltage			1.7	7 9	mV
TCV_{OS}	Input Offset Voltage Average Drift			5		$\mu\text{V}/^\circ\text{C}$
I_B	Input Bias Current			15	250 500	nA
I_{OS}	Input Offset Current			5	50 150	nA
CMRR	Common Mode Rejection Ratio	$0\text{V} \leq V_{\text{CM}} \leq 4.0\text{V}$	50	65		dB
PSRR	Power Supply Rejection Ratio	$2.7\text{V} \leq V^+ \leq 5\text{V}$ $V_O = 1\text{V}$, $V_{\text{CM}} = 1\text{V}$	50	60		dB
V_{CMR}	Input Common-Mode Voltage Range	For CMRR $\geq 50\text{dB}$	0	-0.2 4.2	4.0	V
A_V	Large Signal Voltage Gain	$R_L = 2\text{ k}\Omega$ (Note 11)	15 10	100		V/mV
V_O	Output Swing	$R_L = 2\text{ k}\Omega$ to 2.5V	$V^+ - 300$ $V^+ - 400$	$V^+ - 50$		mV
				50	300 400	mV
		$R_L = 10\text{ k}\Omega$ to 2.5V	$V^+ - 100$ $V^+ - 200$	$V^+ - 10$		mV
				10	180 280	mV
I_O	Output Short Circuit Current	Sourcing, $V_O = 0\text{V}$	5	60		mA
		Sinking, $V_O = 5\text{V}$	10	90		mA
I_S	Supply Current	LMV321 Single amplifier		110	140	μA
		LMV358 Both amplifiers		190	340 600	μA
		LMV324 All four amplifiers		340	680 1100	μA
θ_{JA}	Thermal Resistance Junction-to-Ambient	SOT353 (Note 12)		330		$^\circ\text{C}/\text{W}$
		SOT25 (Note 12)		250		$^\circ\text{C}/\text{W}$
		TSSOP-14L (Note 12)		100		$^\circ\text{C}/\text{W}$
		MSOP-8L (Note 12)		203		$^\circ\text{C}/\text{W}$
		SOP-8L (Note 12)		150		$^\circ\text{C}/\text{W}$

Electrical Characteristics (Continued)

5V AC Electrical Characteristics

Unless otherwise specified, all limits guaranteed for $T_A = 25^\circ\text{C}$, $V^+ = 5\text{V}$, $V^- = 0\text{V}$, $V_{\text{CM}} = 2.0\text{V}$, $V_O = V^+/2$ and $R_L > 1\text{ M}\Omega$. **Boldface** limits apply at the temperature extremes.

Symbol	Parameter	Test Conditions	Min (Note 10)	Typ. (Note 9)	Max (Note 10)	Unit
SR	Slew Rate	(Note 13)		1		V/ μs
GBWP	Gain-Bandwidth Product	$C_L = 200\text{ pF}$		1		MHz
Φ_m	Phase Margin			60		Deg
G_m	Gain Margin			10		dB
e_n	Input-Referred Voltage Noise	$f > 50\text{ kHz}$		23		$\frac{\text{nV}}{\sqrt{\text{Hz}}}$

- Notes:
7. Shorting output to V^+ will adversely affect reliability.
 8. Shorting output to V^- will adversely affect reliability.
 9. Typical values represent the most likely parametric norm as determined at the time of characterization. Actual typical values may vary over time and will also depend on the application and configuration. The typical values are not tested and are not guaranteed on shipped production material.
 10. All limits are guaranteed by testing or statistical analysis.
 11. R_L is connected to V^- . The output voltage is $0.5\text{V} \leq V_O \leq 4.5\text{V}$.
 12. All numbers are typical, and apply for packages soldered directly onto a PC board in still air.
 13. Connected as voltage follower with 3V step input. Number specified is the slower of the positive and negative slew rates.

Typical Performance Characteristics

Unless otherwise specified, $V_s = +5V$, single supply, $T_A = 25^\circ C$

Supply Current vs. Supply Voltage

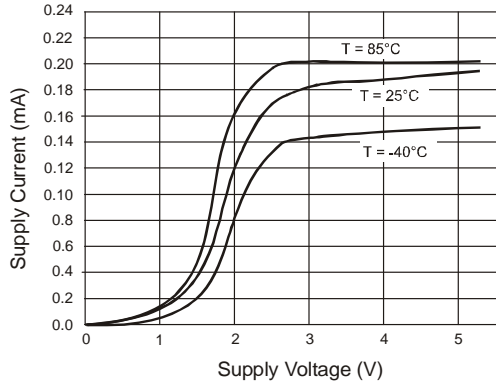

Output Voltage Swing vs. Supply Voltage

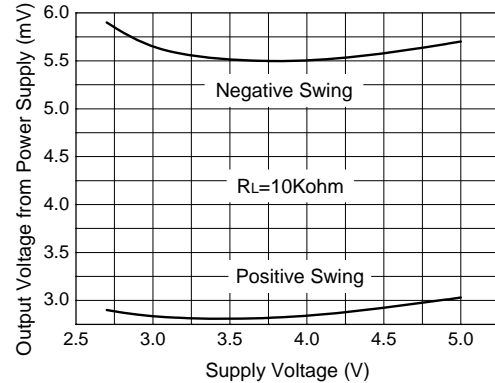

PSRR vs. Frequency

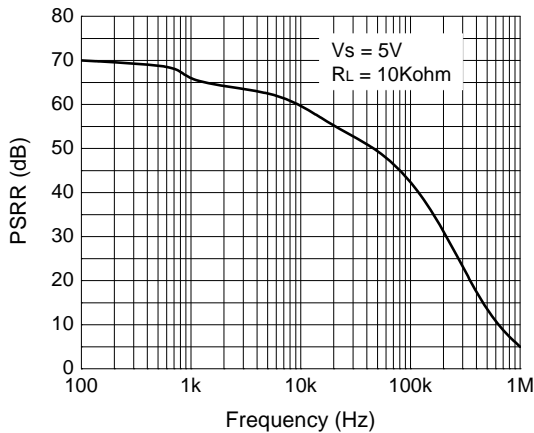

CMRR vs. Frequency

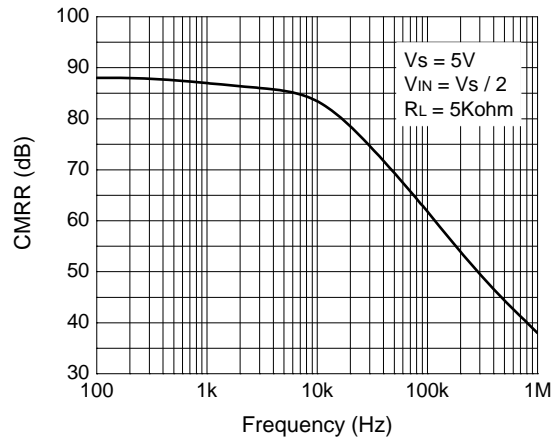

CMRR vs. Input Common Mode Voltage

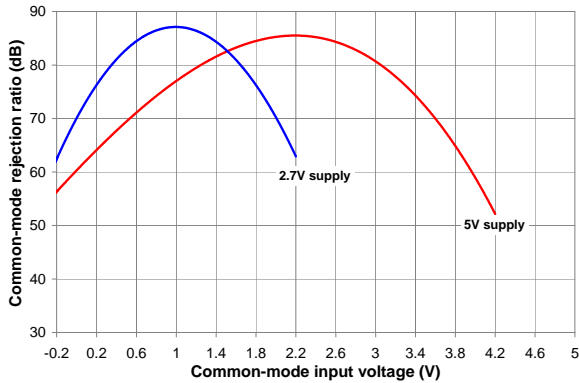

ΔV_{os} vs. CMR

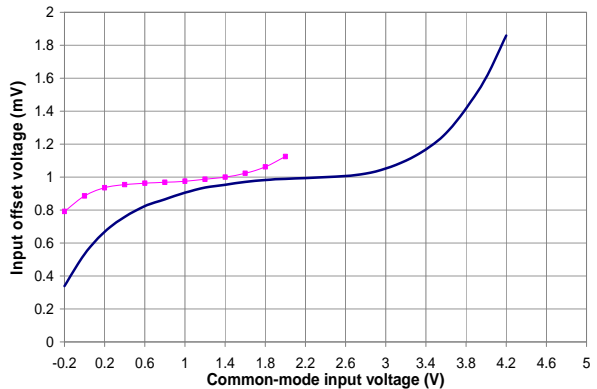

Typical Performance Characteristics (Continued)

Sourcing Current vs. Output Voltage (2.7V)

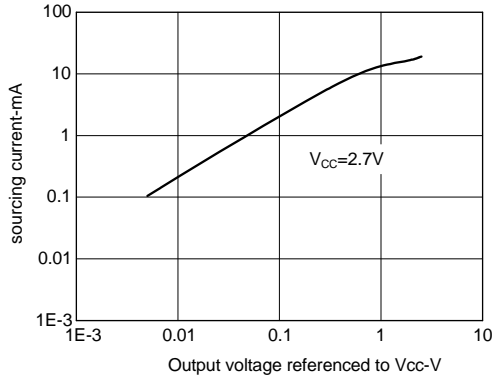

Sourcing Current vs. Output Voltage (5V)

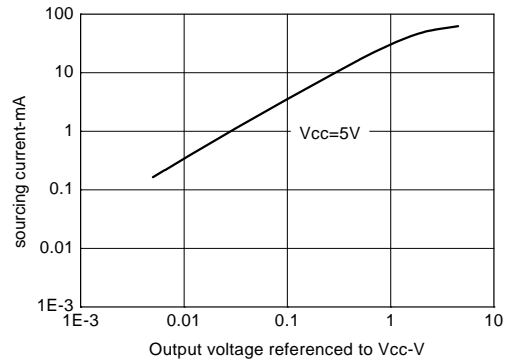

Sinking Current vs. Output Voltage (2.7V)

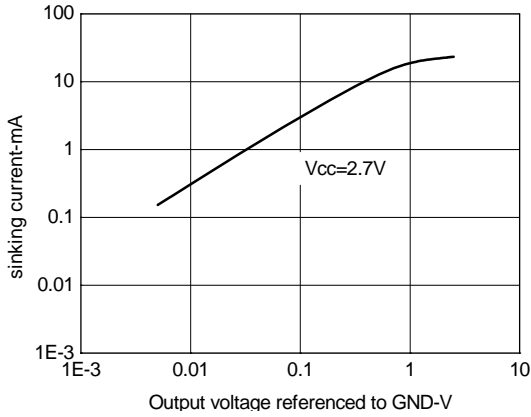

Sinking Current vs. Output Voltage (5V)

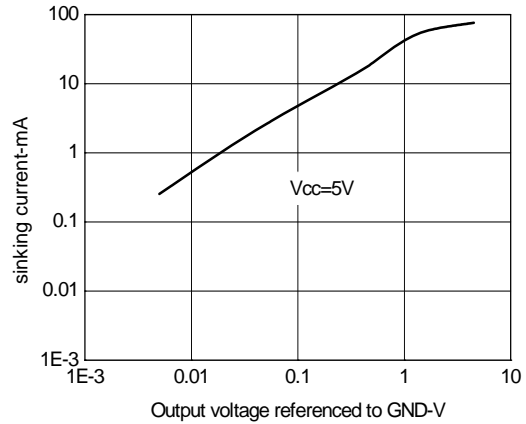

Input Voltage vs. Output Voltage

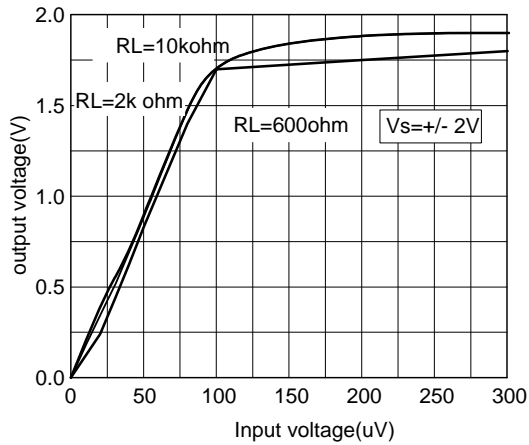

Output voltage vs. input voltage

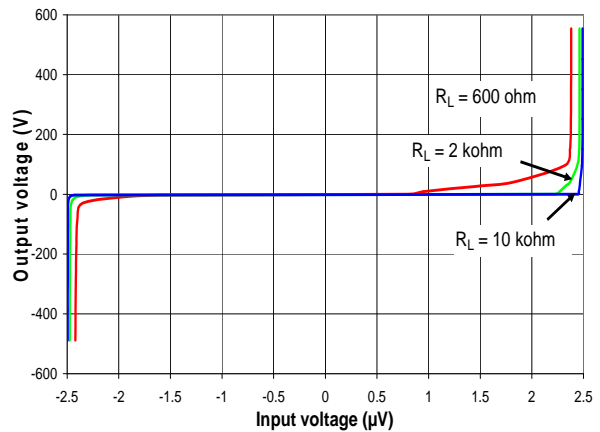

Typical Performance Characteristics (Continued)

Frequency Response vs. Resistive Load (2.7V)

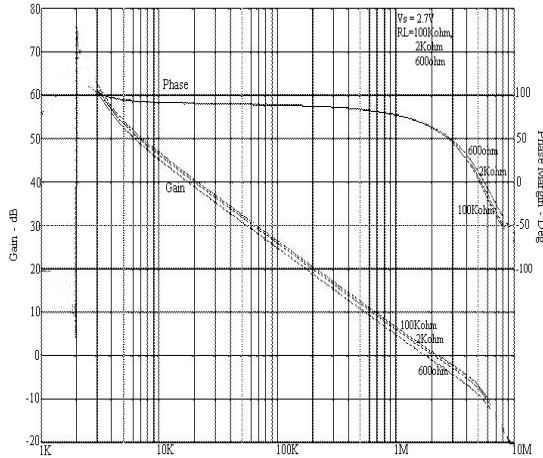

Frequency Response vs. Resistive Load (5V)

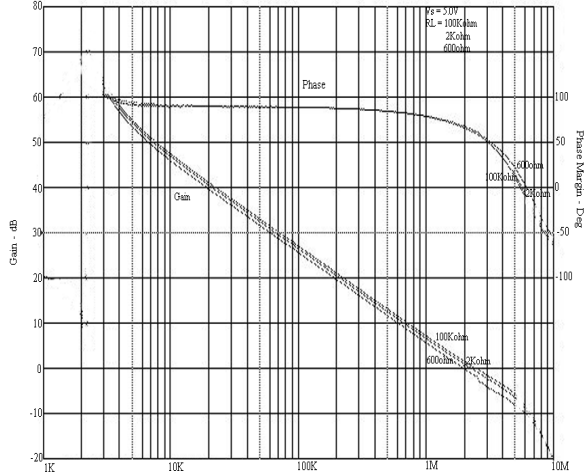

Frequency Response vs. Capacitive Load (2.7V)

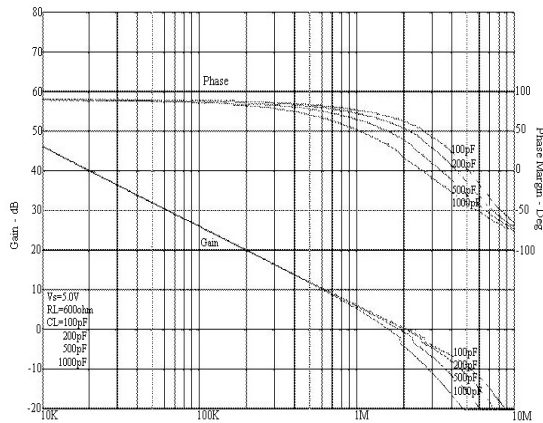

Frequency Response vs. Capacitive Load (5V)

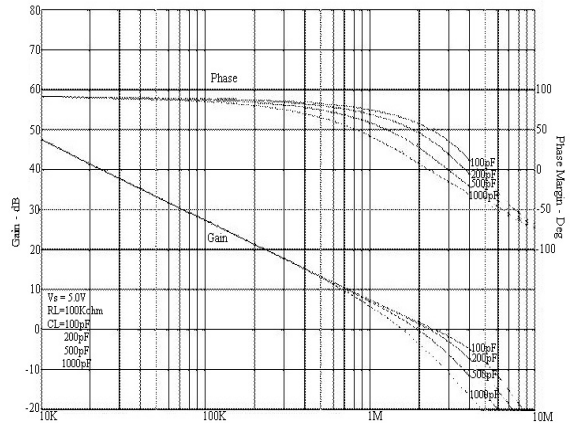

Crosstalk vs. Frequency

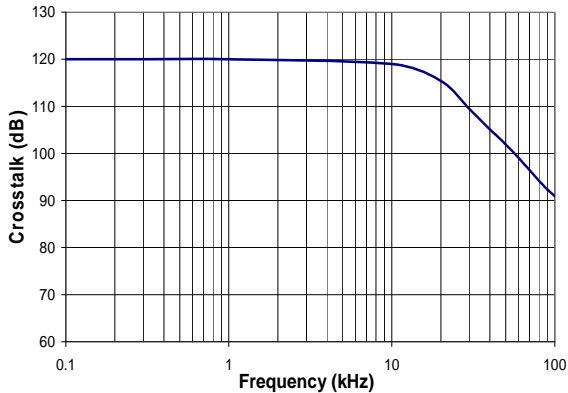

Typical Performance Characteristics (Continued)

Inverting Large Signal Pulse Response

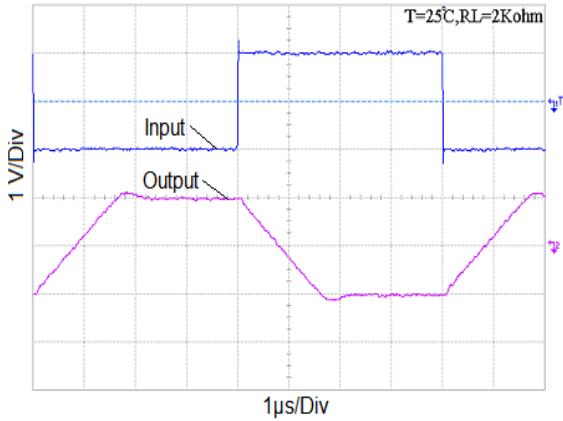

Inverting Large Signal Pulse Response

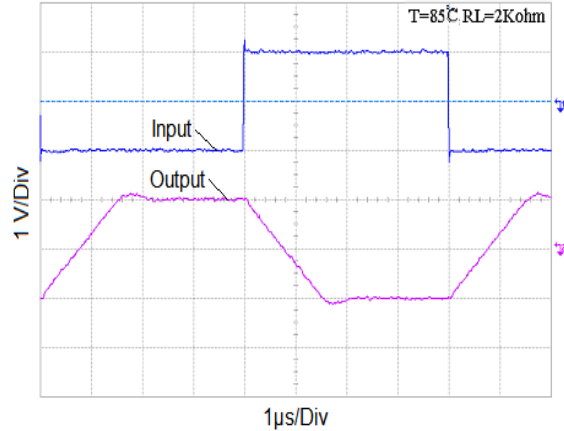

Inverting Large Signal Pulse Response

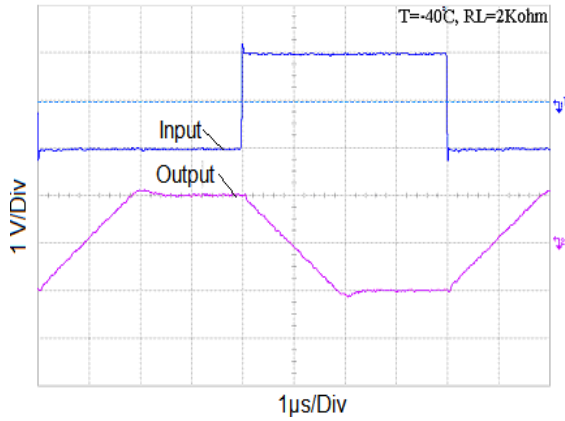

Inverting Small Signal Pulse Response

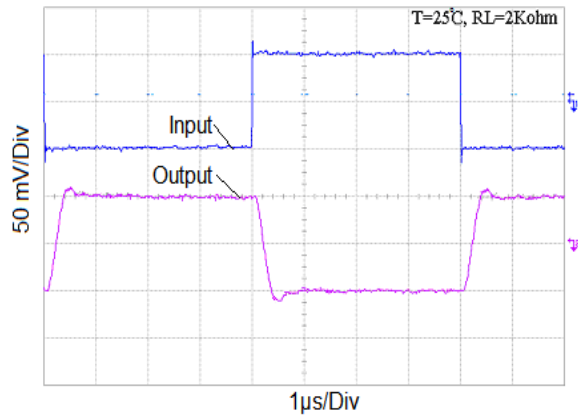

Inverting Small Signal Pulse Response

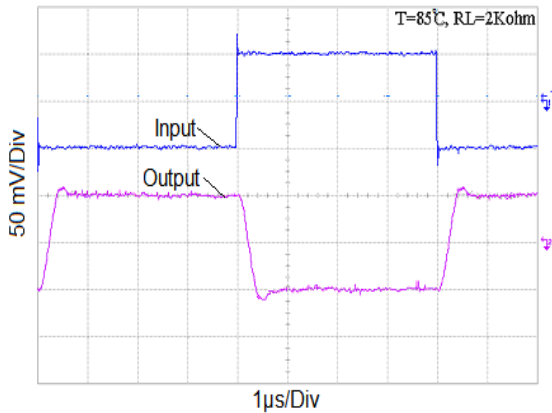

Inverting Small Signal Pulse Response

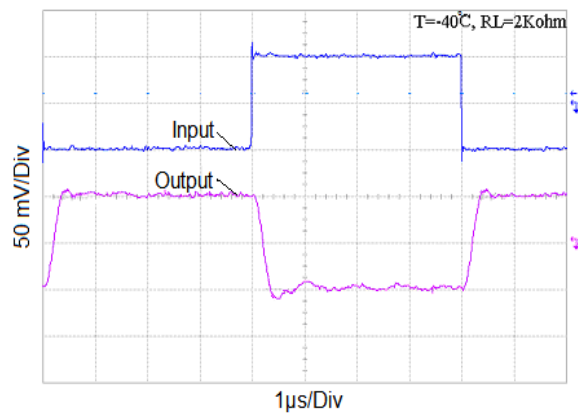

Typical Performance Characteristics (Continued)

Stability vs. Capacitive Load

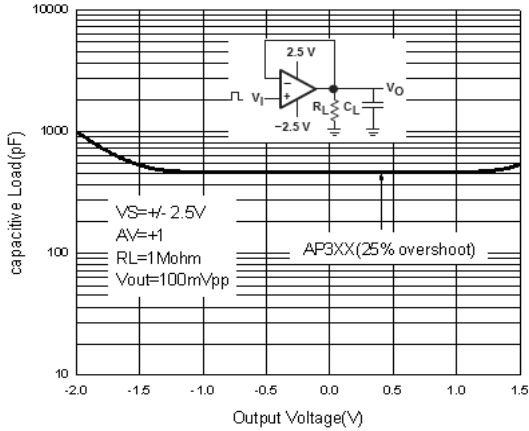

Stability vs. Capacitive Load

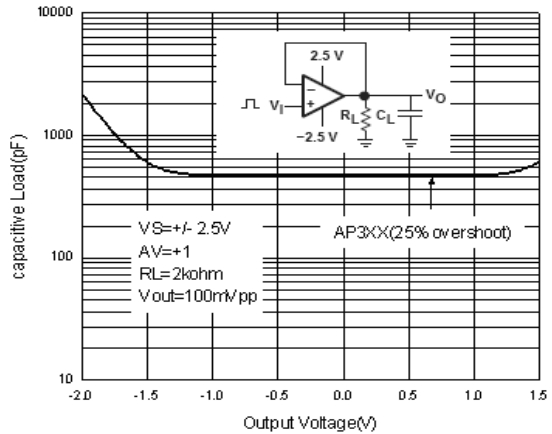

Stability vs. Capacitive Load

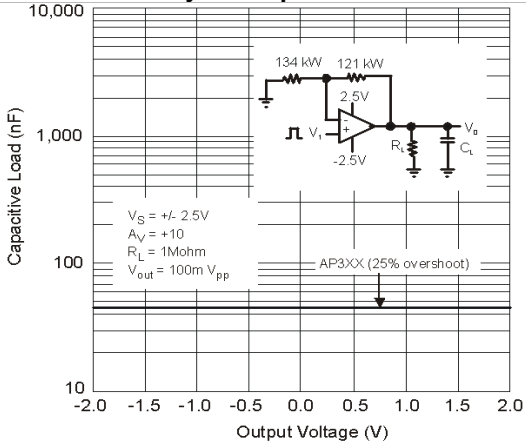

Stability vs. Capacitive Load

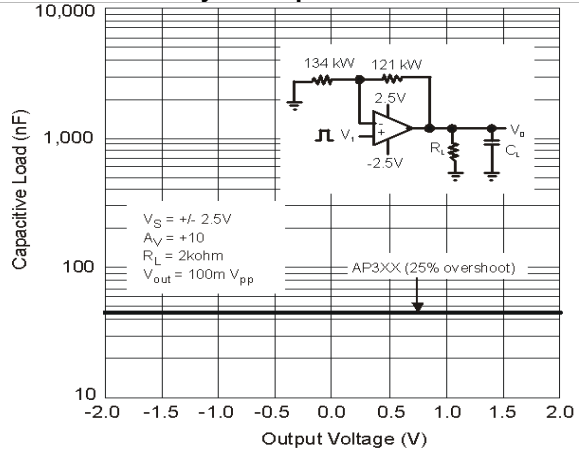

Slew Rate vs. Supply Voltage

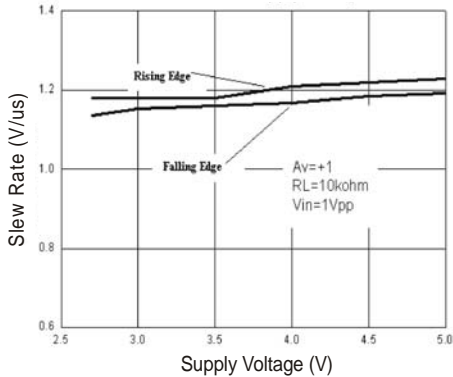

Input Voltage Noise

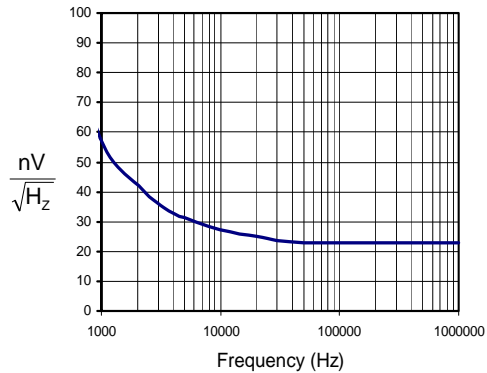

Marking Information

(1) SOT25 / SOT353

(Top View)

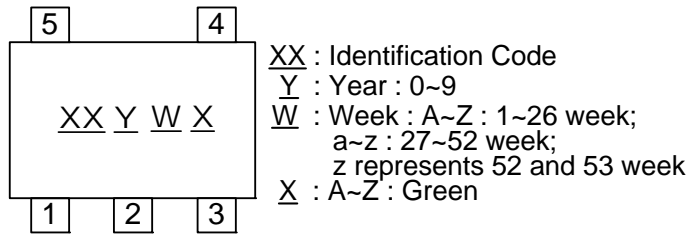

Device	Package type	Identification Code
LMV321W	SOT25	BX
LMV321SE	SOT353	BY

(2) TSSOP-14L

(Top View)

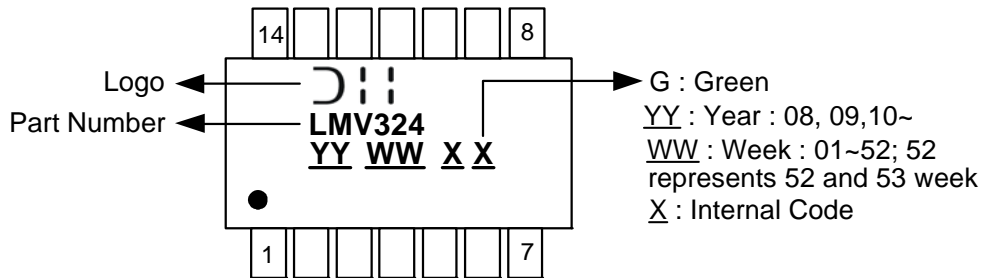

(3) SOP-8L

(Top view)

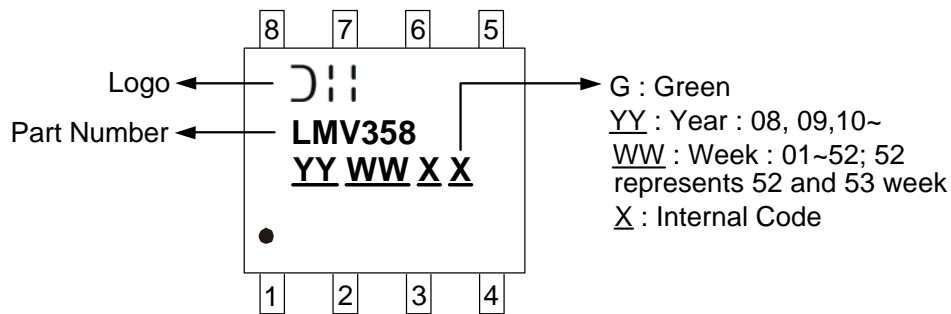

Marking Information (Continued)

(4) MSOP-8L

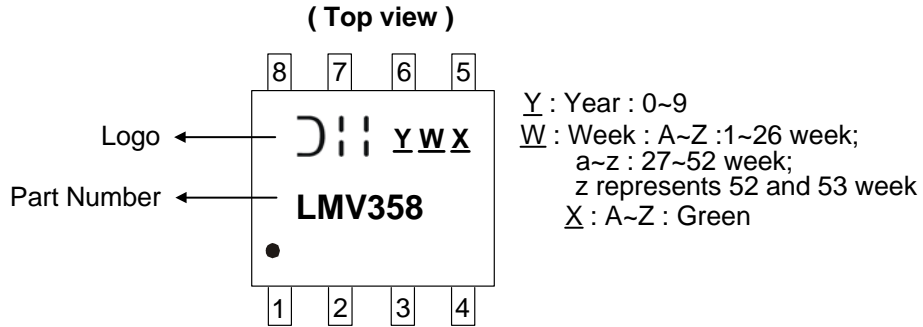

Package Information (All Dimensions in mm)

(1) Package Type: SOT25

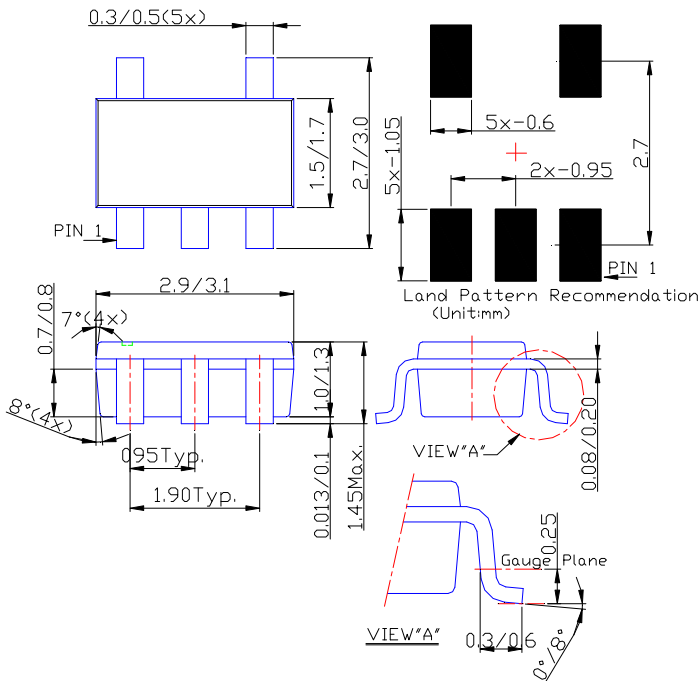

Package Information (Continued)

(2) Package Type: SOT353

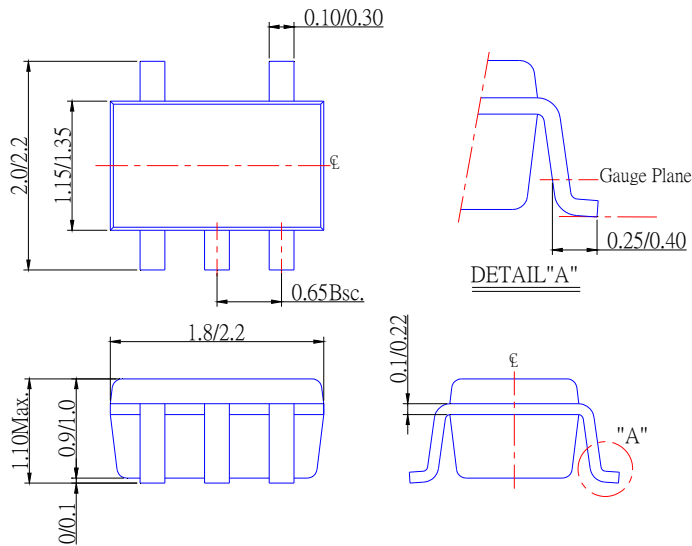

(3) Package Type: TSSOP-14L

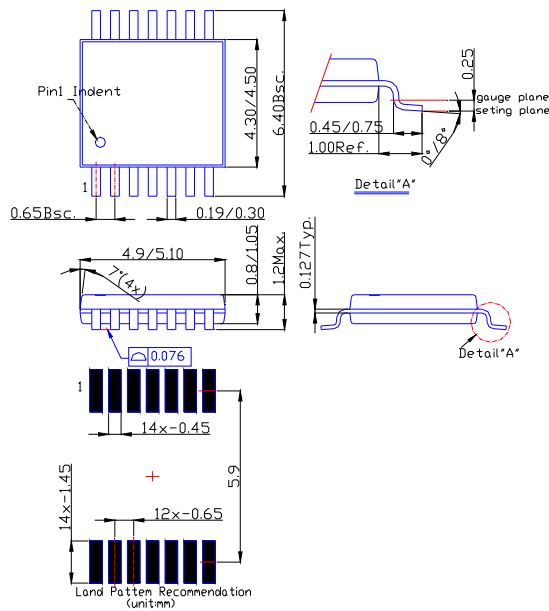

Package Information (Continued)

(4) Package Type: SOP-8L

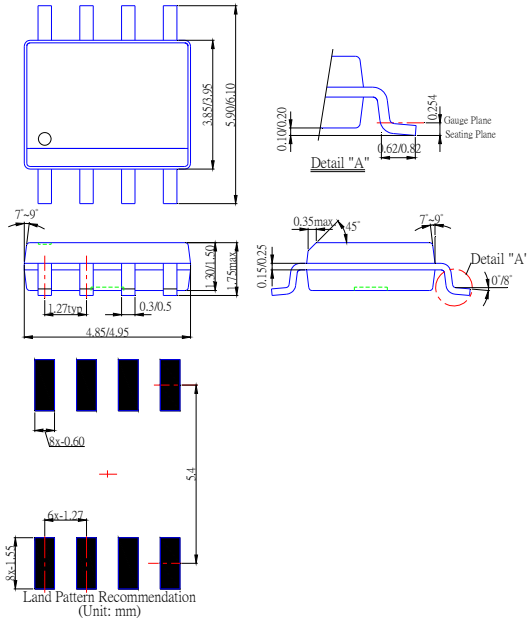

(5) Package Type: MSOP-8L

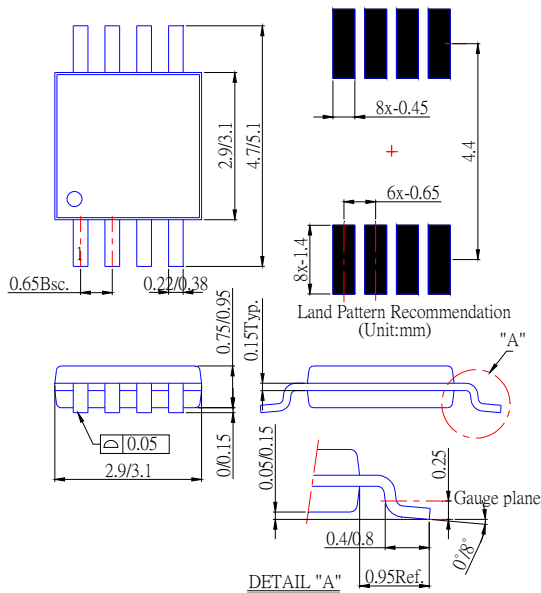

IMPORTANT NOTICE

DIODES INCORPORATED MAKES NO WARRANTY OF ANY KIND, EXPRESS OR IMPLIED, WITH REGARDS TO THIS DOCUMENT, INCLUDING, BUT NOT LIMITED TO, THE IMPLIED WARRANTIES OF MERCHANTABILITY AND FITNESS FOR A PARTICULAR PURPOSE (AND THEIR EQUIVALENTS UNDER THE LAWS OF ANY JURISDICTION).

Diodes Incorporated and its subsidiaries reserve the right to make modifications, enhancements, improvements, corrections or other changes without further notice to this document and any product described herein. Diodes Incorporated does not assume any liability arising out of the application or use of this document or any product described herein; neither does Diodes Incorporated convey any license under its patent or trademark rights, nor the rights of others. Any Customer or user of this document or products described herein in such applications shall assume all risks of such use and will agree to hold Diodes Incorporated and all the companies whose products are represented on Diodes Incorporated website, harmless against all damages.

Diodes Incorporated does not warrant or accept any liability whatsoever in respect of any products purchased through unauthorized sales channel.

Should Customers purchase or use Diodes Incorporated products for any unintended or unauthorized application, Customers shall indemnify and hold Diodes Incorporated and its representatives harmless against all claims, damages, expenses, and attorney fees arising out of, directly or indirectly, any claim of personal injury or death associated with such unintended or unauthorized application.

Products described herein may be covered by one or more United States, international or foreign patents pending. Product names and markings noted herein may also be covered by one or more United States, international or foreign trademarks.

LIFE SUPPORT

Diodes Incorporated products are specifically not authorized for use as critical components in life support devices or systems without the express written approval of the Chief Executive Officer of Diodes Incorporated. As used herein:

A. Life support devices or systems are devices or systems which:

1. are intended to implant into the body, or
2. support or sustain life and whose failure to perform when properly used in accordance with instructions for use provided in the labeling can be reasonably expected to result in significant injury to the user.

B. A critical component is any component in a life support device or system whose failure to perform can be reasonably expected to cause the failure of the life support device or to affect its safety or effectiveness.

Customers represent that they have all necessary expertise in the safety and regulatory ramifications of their life support devices or systems, and acknowledge and agree that they are solely responsible for all legal, regulatory and safety-related requirements concerning their products and any use of Diodes Incorporated products in such safety-critical, life support devices or systems, notwithstanding any devices- or systems-related information or support that may be provided by Diodes Incorporated. Further, Customers must fully indemnify Diodes Incorporated and its representatives against any damages arising out of the use of Diodes Incorporated products in such safety-critical, life support devices or systems.

Copyright © 2009, Diodes Incorporated

www.diodes.com