

Controls – Contactors and Contactor Assemblies

3



3/2	Introduction	
	3RT, 3TB, 3TF Contactors for Switching Motors	
3/4	General data	
3/8	3RT10 contactors, 3-pole, 3 ... 250 kW	3/78
3/30	3RT12 vacuum contactors, 3-pole, 110 ... 250 kW	3/82
3/31	3TF6 vacuum contactors, 3-pole, 335 ... 450 kW	3/83
3/34	3TB5 contactors with DC solenoid system, 3-pole, 55 ... 200 kW	3/85
3/35	3TF2 contactors, 3-pole, 2.2 ... 4 kW	3/88
	3RA13, 3RA14 Contactor Assemblies	
	<u>3RA13 Reversing Contactor Assemblies</u>	
3/38	3RA13 complete units, 3 ... 45 kW	
3/43	Components for customer assembly	
	<u>3RA14 Contactor Assemblies for Wye-Delta Starting</u>	
3/46	3RA14 complete units, 3 ... 75 kW	3/90
3/53	Components for customer assembly	
	3TD, 3TE Contactor Assemblies	
3/54	3TD6 reversing contactor assemblies, 335 kW	
3/55	3TE6 contactor assemblies for wye-delta starting, 630 kW	
	3RT, 3RH, 3TB, 3TC, 3TH, 3TK Contactors for Special Applications	
	<u>3RT14 Contactors for Switching Resistive Loads (AC-1)</u>	
3/56	3-pole, 140 ... 690 A	
	<u>3RT13 Contactors for Switching Resistive Loads (AC-1)</u>	
3/58	4-pole, 4 NO, 18 ... 140 A	
	<u>3TK1 Contactors for Switching Resistive Loads (AC-1)</u>	
3/61	4-pole, 4 NO, 200 ... 1000 A	
	<u>3TK20 Contactors</u>	
3/62	4-pole, 4 kW	
	<u>3RT15 Contactors</u>	
3/64	4-pole, 2 NO + 2 NC, 4 ... 18.5 kW	3/101
	<u>3RT16 Capacitor Contactors</u>	
3/66	12.5 ... 50 kvar	
	<u>Contactors with Extended Tolerance $0.7 \dots 1.25 \times U_s$ for Railway Applications</u>	
3/67	3RH11 contactor relays	
3/68	3TH4 contactor relays	
3/69	3RT10 motor contactors, 5.5 ... 45 kW	
3/73	3TB5 motor contactors, 55 ... 200 kW	
3/74	3TC contactors for switching DC voltage, 2-pole	
	<u>3TC Contactors for Switching DC Voltage</u>	
3/75	1- and 2-pole, 32 ... 400 A	
	3RH, 3TH Contactor Relays	
3/78	3RH1 contactor relays, 4- and 8-pole	
3/82	3RH14 latched contactor relays, 4-pole	
3/83	3TH4 contactor relays, 8- and 10-pole	
3/85	3TH2 contactor relays, 4- and 8-pole	
3/88	3RH11 coupling relays for switching auxiliary circuits, 4-pole	
	3RT Coupling Relays	
3/90	3RT10 coupling relays (interface), for switching motors, 3-pole, 3 ... 11 kW	
	3TX7, 3RS18 Coupling Relays	
	<u>3TX7 Coupling Relays, Narrow Design</u>	
3/95	Relay couplers	
3/97	Relay couplers with plug-in design	
3/99	Semiconductor couplers	
	<u>3RS18 Coupling Relays with Industrial Housing</u>	
3/101	Relay couplers	
	LZX Plug-in Relays	
3/102	Relay couplers	
	3TG10 Power Relays/Miniature Contactors	
3/106	4-pole, 4 kW	
	Accessories and Spare Parts	
	<u>for 3RT, 3RH Contactors and Contactor Relays</u>	
3/107	Accessories for 3RT, 3RH contactors and contactor relays	
3/126	Spare parts for 3RT, 3RH contactors and contactor relays	
	<u>for 3T Contactors and Contactor Relays</u>	
3/134	Accessories for 3TB, 3TC, 3TF, 3TG, 3TK contactors	
3/139	Accessories for 3TH contactor relays	
3/142	Spare parts for 3TB, 3TC, 3TF, 3TK contactors	

Introduction

Overview



Size	S00	S0	S2
Type	3RT10 1	3RT10 2	3RT10 3

3RT10 contactors • 3RT12 and 3TF68/69 vacuum contactors

Type AC, DC operation	3RT10 15	3RT10 16	3RT10 17	3RT10 23	3RT10 24	3RT10 25	3RT10 26	3RT10 34	3RT10 35	3RT10 36
	(p. 3/12, 3/20)			(p. 3/14, 3/22)				(p. 3/16, 3/24)		
Type	--	--	--	--	--	--	--	--	--	--

AC-3

I_e /AC-3/400 V	A	7	9	12	9	12	17	25	32	40	50
400 V	kW	3	4	5.5	4	5.5	7.5	11	15	18.5	22
230 V	kW	2.2	3	3	3	3	4	5.5	7.5	11	15
500 V	kW	3.5	4.5	5.5	4.5	7.5	10	11	18.5	22	30
690 V	kW	4	5.5	5.5	5.5	7.5	11	11	18.5	22	22
1 000 V	kW	--	--	--	--	--	--	--	--	--	--
	3RT10/12										
	3RT10/12										

AC-4 (for $I_a = 6 \times I_e$)

400 V	kW	3	4	4	4	5.5	7.5	7.5	15	18.5	22
400 V	kW	1.15	2	2	2	2.6	3.5	4.4	8.2	9.5	12.6
	3RT10/12										
	(200 000 operating cycles)										

AC-1 (40 °C, ≤ 690 V)

I_e	3RT10/12	A	18	22	22	40	40	40	40	50	60	60
-------	----------	----------	-----------	-----------	-----------	-----------	-----------	-----------	-----------	-----------	-----------	-----------

3RT14 AC-1 contactors

Type	--	--	--
I_e /AC-1/40 °C/≤ 690 V	A	--	--

Accessories for contactors

Auxiliary switch blocks front	3RH19 11	(p. 3/110)	3RH19 21	(p. 3/110)
lateral	--		3RH19 21	(p. 3/114)
Terminal covers	--		--	3RT19 36-4EA2 (p. 3/124)
Box terminal blocks	--		--	--
Surge suppressors	3RT19 16	(p. 3/119)	3RT19 26	(p. 3/119)
			3RT19 26/36	(p. 3/119)

3RU1 and 3RB2 overload relays (protection equipment: overload relays)

3RU11 , thermal, CLASS 10	3RU11 16	0.1 ... 12 A (Chap. 5)	3RU11 26	1.8 ... 25 A (Chapter 5)	3RU11 36	5.5 ... 50 A (Chapter 5)
3RB20/21 , solid-state, CLASS 5, 10, 20 and 30	3RB20 16	0.1 ... 12 A (Chap. 5)	3RB20 26	3 ... 25 A (Chapter 5)	3RB20 36	6 ... 50 A (Chapter 5)
	3RB21 16		3RB21 26		3RB21 36	
3RB22/23 , solid-state, CLASS 5, 10, 20 and 30	3RB2. 83 + 3RB29 06	0.3 ... 25 A (Chapter 5)			3RB2. 83 + 3RB29 06	10 ... 100 A (Chapter 5)

3RV10 motor starter protectors (protection equipment: circuit-breakers)

Type	3RV10 11	0.18 ... 12 A (Chap. 5)	3RV10 21	9 ... 25 A (Chapter 5)	3RV10 31	22 ... 50 A (Chapter 5)
Link modules	3RA19 11	(Chap. 5)	3RA19 21	(Chapter 5)	3RA19 31	(Chapter 5)

3RA13 reversing contactor assemblies

Complete units	Type	3RA13 15	3RA13 16	3RA13 17	3RA13 24	3RA13 25	3RA13 26	3RA13 34	3RA13 35	3RA13 36
		(p. 3/39)			(p. 3/40)			(p. 3/41)		
400 V	kW	3	4	5.5	5.5	7.5	11	15	18.5	22
Installation kits/wiring connectors		3RA19 13-2A		(p. 3/44)	3RA19 23-2A		(p. 3/44)	3RA19 33-2A		(p. 3/44)
Mechanical interlocks		3RA19 12-2H		(p. 3/45)	3RA19 24-1A-2B		(p. 3/43)			

3RA14 contactor assemblies for wye-delta starting

Complete units	Type	3RA14 15	3RA14 16	3RA14 23	3RA14 25	3RA14 34	3RA14 35	3RA14 36
		(p. 3/48)		(p. 3/49)		(p. 3/50)	(p. 3/51)	
400 V	kW	5.5	7.5	11	15/18.5	22/30	37	45
Installation kits/wiring connectors		3RA19 13-2B		(p. 3/53)	3RA19 23-2B		(p. 3/53)	3RA19 33-2B-2C (p. 3/53)



S3
3RT1. 4

S6
3RT1. 5

S10
3RT1. 6

S12
3RT1. 7

14
3TF6

3RT10 44 (p. 3/18, 3/24)	3RT10 45	3RT10 46	3RT10 54 (p. 3/26)	3RT10 55	3RT10 56	3RT10 64 (p. 3/26)	3RT10 65	3RT10 66	3RT10 75 (p. 3/26)	3RT10 76	--		
--			--			3RT12 64 (p. 3/30)	3RT12 65	3RT12 66	3RT12 75 (p. 3/30)	3RT12 76	3TF68 (p. 3/32)	3TF69	
65	80	95	115	150	185	225	265	300	400	500	630	820	
30	37	45	55	75	90	110	132	160	200	250	335	450	
18.5	22	22	37	45	55	55	75	90	132	160	200	260	
37	45	55	75	90	110	160	160	200	250	355	434	600	
45	55	55	110	132	160	200	250	250	400	400/500	600	800	
30	37	37	75	90	90	90/315	132/355	132/400	250/560	250/710	600	800	
30	37	45	55	75	90	110	132	160	200	250	355	400	
15.1	17.9	22	29	38	45	54/78	66/93	71/112	84/140	98/161	168	191	
100	120	120	160	185	215	275/330	330	330	430/610	610	700	910	
3RT14 46		(p. 3/56)	3RT14 56		(p. 3/57)	3RT14 66		(p. 3/57)	3RT14 76		(p. 3/57)	--	
140			275			400			690			--	
												3TY7 561	(p. 3/135)
3RT19 46-4EA1/2		(p. 3/124)	3RT19 56-4EA1/2/3		(p. 3/124)	3RT19 66-4EA1/2/3		(p. 3/124)				3TX7 686/696	(p. 3/135)
--			3RT19 55/56-4G		(p. 3/124)	3RT19 66-4G		(p. 3/124)				--	
			3RT19 56-1C		(RC element) (p. 3/120)							3TX7 572	(p. 3/134)
3RU11 46	18 ... 100 A (Chapter 5)		--			--			--			--	
3RB20 46	12.5 ... 100 A (Chap. 5)		3RB20 56	50 ... 200 A (Chapter 5)		3RB20 66	55 ... 630 A		3RB20 66	160 ... 630 A		3RB20 66	160 ... 630 A
3RB21 46			3RB21 56			3RB21 66	(Chapter 5)		3RB21 66	(Chapter 5)		3RB21 66	(Chapter 5)
			3RB2. 83 + 3RB29 56	20 ... 200 A (Chapter 5)		3RB2. 83 + 3RB29 66	63 ... 630 A (Chapter 5)						
3RV10 41	45 ... 100 A (Chapter 5)		--			--			--			--	
3RA19 41	(Chapter 5)		--			--			--			--	
3RA13 44	3RA13 45	3RA13 46	--			--			--			3TD68 04	(p. 3/54)
(p. 3/42)												335	
30	37	45	55	75	90	110	132	160	200	250		335	
3RA19 43-2A		(p. 3/44)	3RA19 53-2A		(p. 3/44)	3RA19 63-2A		(p. 3/44)	3RA19 73-2A		(p. 3/44)	3TX7 680-1A	
			3RA19 54-2A		(p. 3/43)							3TX7 686-1A	
3RA14 44	3RA14 45		--			--			--			3TE68 04	(p. 3/55)
(p. 3/52)												630	
55	75		--			--			--			630	
3RA19 43-2B/-2C		(p. 3/53)	3RA19 53-2B		(p. 3/53)	3RA19 63-2B		(p. 3/53)	3RA19 73-2B		(p. 3/53)	3TX7 680-1B	

3RT, 3TB, 3TF Contactors for Switching Motors

General data

Overview

3RT1 contactors and coupling relays Size S00 with mountable accessories

The SIRIUS generation of controls is a complete, modular system family, logically designed right down to the last detail, from the basic units to the accessories.

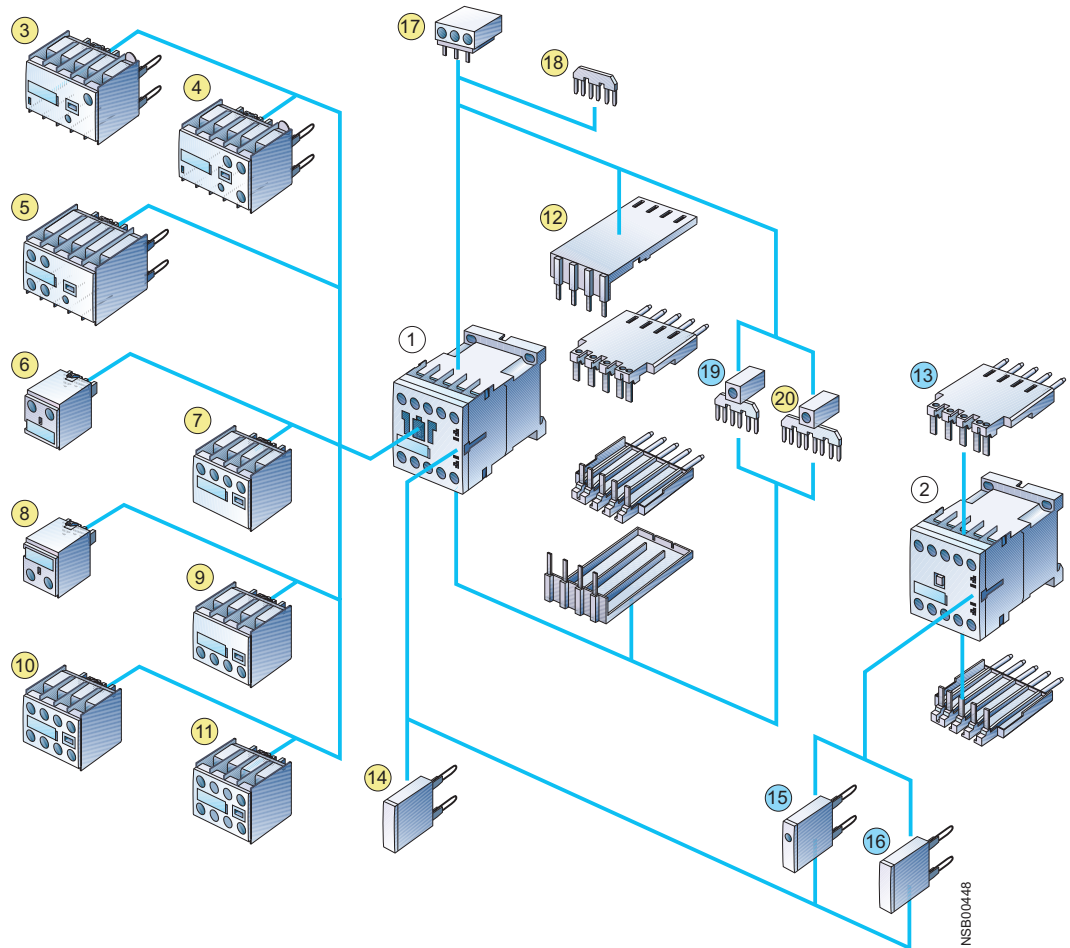

- ① Contactor (page 3/12)
 - ② Coupling relay (page 3/90)
 - ③ Solid-state time-delay block, ON-delay (page 3/118)
 - ④ Solid-state time-delay block, OFF-delay (page 3/118)
 - ⑤ Auxiliary switch block, solid-state time-delay (page 3/117) (ON or OFF-delay or wye-delta function)
 - ⑥ Single-pole auxiliary switch block, cable entry from above (page 3/110)
 - ⑦ 2-pole auxiliary switch block, cable entry from above (page 3/110)
 - ⑧ Single-pole auxiliary switch block, cable entry from below (page 3/110)
 - ⑨ 2-pole auxiliary switch block, cable entry from below (page 3/110)
 - ⑩ 4-pole auxiliary switch block (page 3/110) (terminal designations according to EN 50012 or EN 50005)
 - ⑪ 2-pole auxiliary switch block, standard design or solid-state compatible design (pages 3/110, 3/117) (terminal designations according to EN 50005)
 - ⑫ Solder pin adapter for contactors with 4-pole auxiliary switch block (page 3/123)
 - ⑬ Solder pin adapter for contactors and coupling relays (page 3/122)
 - ⑭ Additional load module for increasing the permissible residual current (page 3/121)
 - ⑮ Surge suppressor with LED (page 3/120)
 - ⑯ Surge suppressor without LED (page 3/120)
 - ⑰ 3-phase feeder terminal (page 3/53)
 - ⑱ Link for paralleling (star jumper), 3-pole, without terminal (page 3/53)
 - ⑲ Link for paralleling, 3-pole, with terminal (page 3/123)
 - ⑳ Link for paralleling, 4-pole, with terminal (page 3/123)
- For contactors
● For contactors and coupling relays (interface)

For contactor assemblies see pages 3/38 to 3/45
 Assembly kit for reversing contactor assemblies
 (mech. interlocking, wiring modules) see page 3/44
 For mountable overload relays see Protection Equipment:
 Overload Relays
 For fuseless load feeders, see Load Feeders, Motor Starters and
 Soft Starters -> 3RA Fuseless Load Feeders

3RT1 contactors Sizes S0 to S3 with mountable accessories

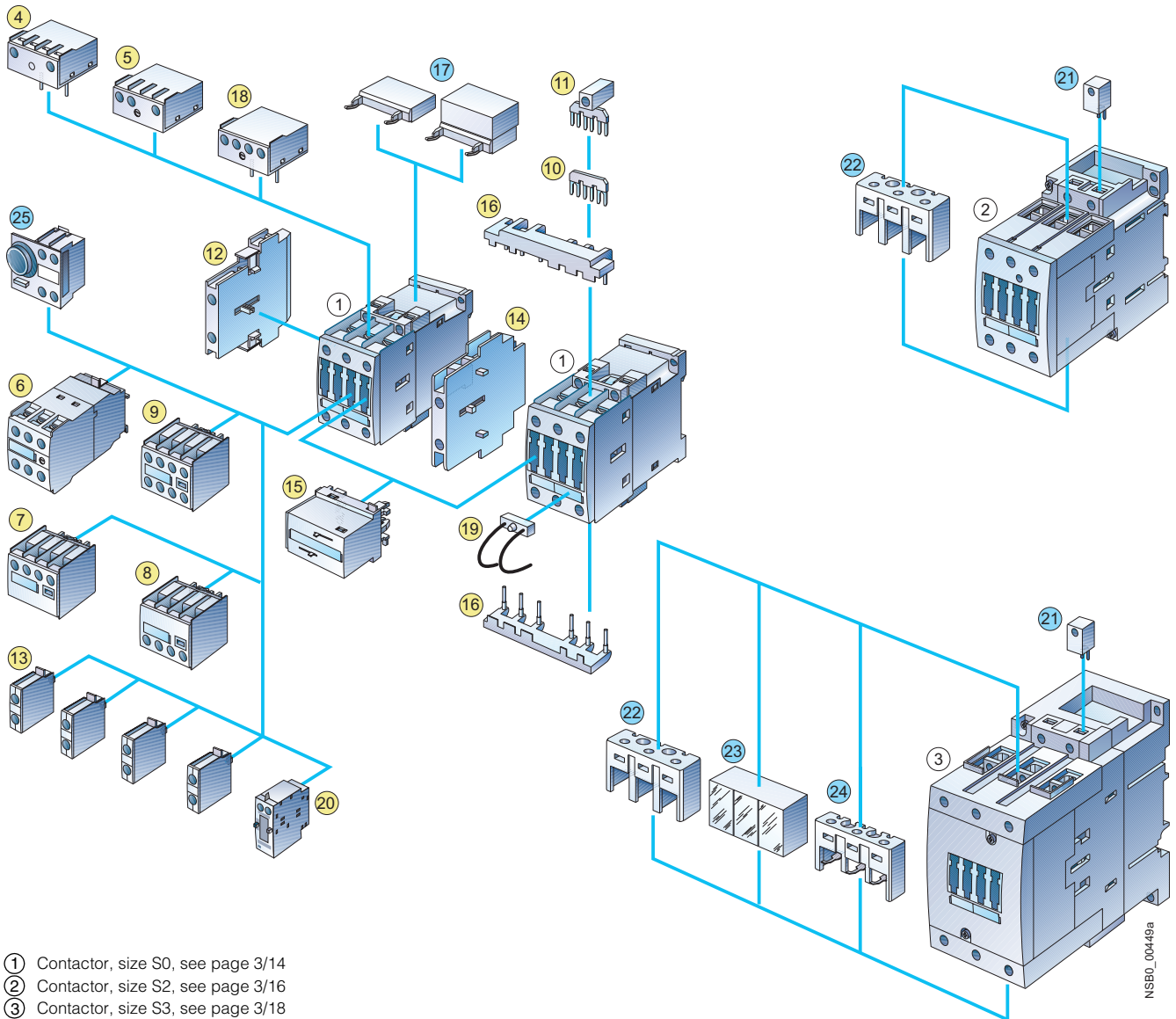

- ① Contactor, size S0, see page 3/14
- ② Contactor, size S2, see page 3/16
- ③ Contactor, size S3, see page 3/18

For sizes S0 to S3:

- ④ Solid-state time-delay block, ON-delay (page 3/118)
- ⑤ Solid-state time-delay block, OFF-delay (page 3/118)
- ⑥ Auxiliary switch block, solid-state time-delay (page 3/117)
(ON or OFF-delay or wye-delta function)
- ⑦ 2-pole auxiliary switch block, cable entry from above (page 3/112)
- ⑧ 2-pole auxiliary switch block, cable entry from below (page 3/112)
- ⑨ 4-pole auxiliary switch block (page 3/112)
(terminal designations according to EN 50012 or EN 50005)
- ⑩ Link for paralleling (star jumper), 3-pole, without terminal (page 3/53)
- ⑪ Link for paralleling, 3-pole, with terminal (page 3/123)
- ⑫ 2-pole auxiliary switch block, laterally mountable (left or right)
(page 3/114) (terminal designations according to EN 50012 or EN 50005)
- ⑬ Single-pole auxiliary switch block (up to 4 can be snapped on)
(page 3/112)
- ⑭ Mechanical interlock, laterally mountable (page 3/43)
- ⑮ Mechanical interlock, mountable on the front (page 3/43)
- ⑯ Wiring connectors on the top and bottom (reversing duty) (page 3/45)
- ⑰ Surge suppressors (page 3/119) (varistor, RC element, diode assembly),
can be mounted on the top or bottom (different for S0 and S2/S3)

- ⑱ Interface for mounting directly onto contactor coil (page 3/122)
- ⑲ LED module for indicating contactor operation (page 3/122)

Only for size S0:

- ⑳ Pneumatic delay block (page 3/118)

Only for sizes S0 and S2:

- ㉑ Mechanical latching

Only for sizes S2 and S3:

- ㉒ Repeat coil terminal for making contactor assemblies (page 3/43)
- ㉓ Terminal cover for box terminals (page 3/124)

Only for size S3:

- ㉔ Terminal cover for cable lug and bar connection (page 3/124)
- ㉕ Auxiliary conductor terminal, 3-pole (page 3/122)

- Accessories identical for sizes S0 to S3
- Accessories differ according to size

3RT, 3TB, 3TF Contactors for Switching Motors

General data

3RT1 contactors Sizes S6 to S12 with accessories

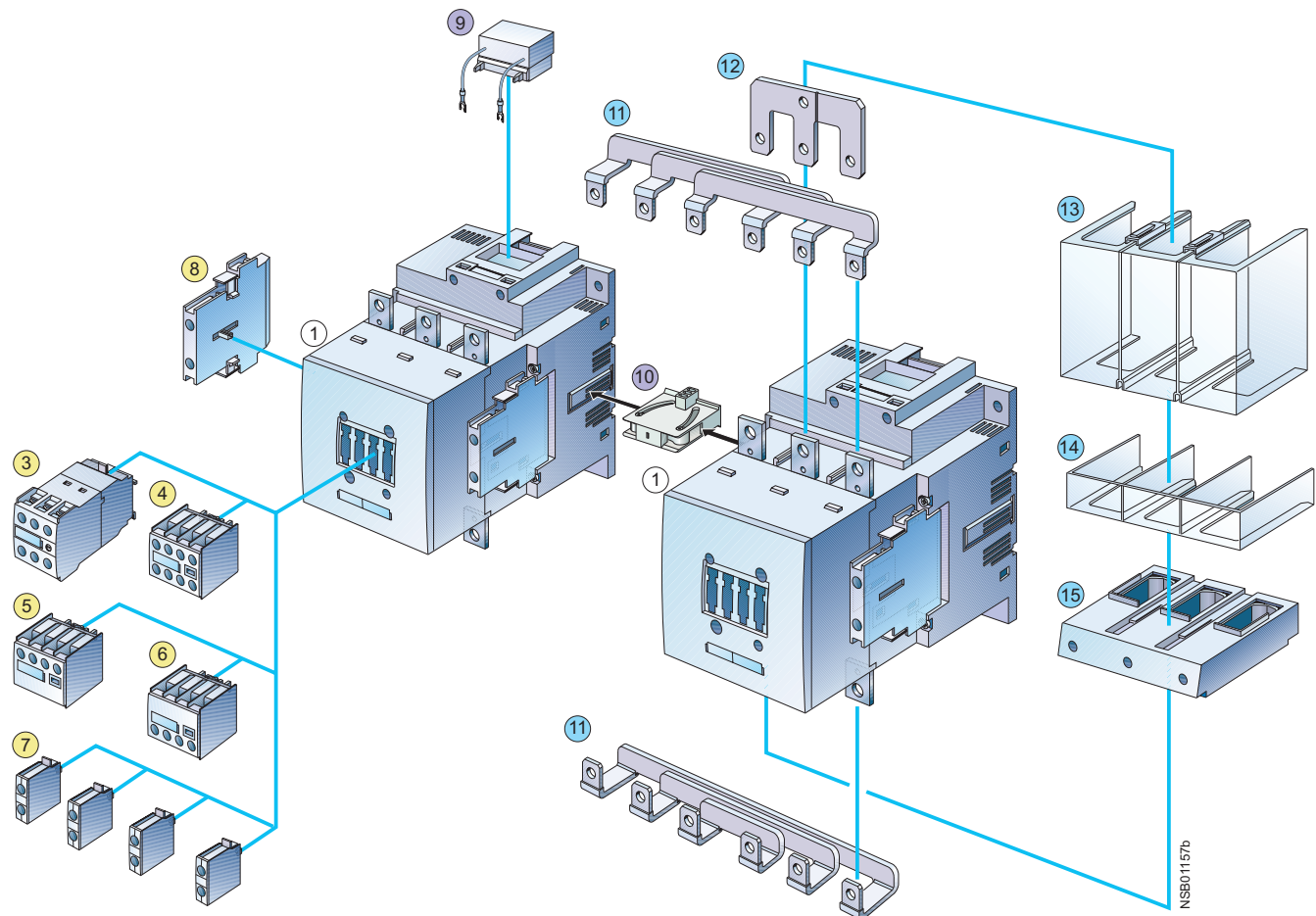

① 3RT10 and 3RT14 air-break contactors, sizes S6, S10 and S12 (page 3/26 and 3/57)

- ③ Auxiliary switch block, solid-state time-delay (page 3/117) (ON or OFF-delay or wye-delta function)
- ④ 4-pole auxiliary switch block (page 3/110) (terminal designations according to EN 50012 or EN 50005)
- ⑤ 2-pole auxiliary switch block, cable entry from above (page 3/112)
- ⑥ 2-pole auxiliary switch block, cable entry from below (page 3/112)
- ⑦ 1-pole auxiliary switch block (up to 4 can be snapped on) (page 3/112)
- ⑧ 2-pole auxiliary switch block, laterally mountable (left or right) (page 3/112) (terminal designations according to EN 50012 or EN 50005) (identical for S0 to S12)
- ⑨ Surge suppressor (RC element) (page 3/120), for plugging into top of withdrawable coil
- ⑩ Mechanical interlock, laterally mountable (page 3/43)

- ⑪ Wiring connectors on the top and bottom (reversing duty) (page 3/45)
 - ⑫ Link for paralleling (star jumper), 3-pole, with through hole (page 3/123), different for sizes S6 and S10/S12
 - ⑬ Terminal cover for cable lug and bar connection (page 3/124), different for sizes S6 and S10/S12
 - ⑭ Terminal cover for box terminal (page 3/124), different for sizes S6 and S10/S12
 - ⑮ Box terminal block (page 3/124), different for sizes S6 and S10/S12
- Accessories identical for sizes S0 to S12
 ● Accessories identical for sizes S6 to S12
 ● Accessories differ according to size

For mountable overload relays see Protection Equipment: Overload Relays -> SIRIUS Overload Relays.

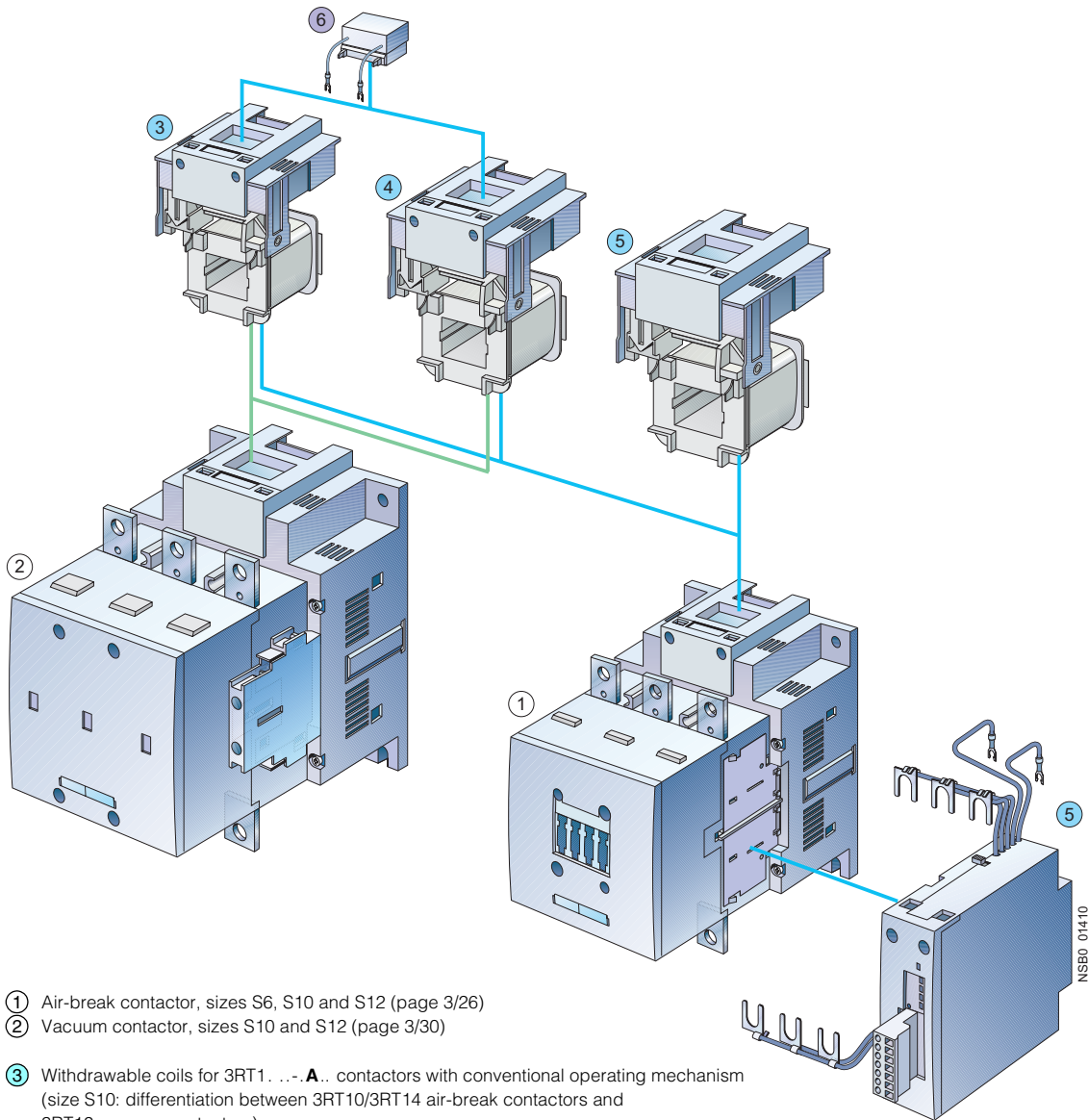

- ① Air-break contactor, sizes S6, S10 and S12 (page 3/26)
- ② Vacuum contactor, sizes S10 and S12 (page 3/30)
- ③ Withdrawable coils for 3RT1...-A.. contactors with conventional operating mechanism
(size S10: differentiation between 3RT10/3RT14 air-break contactors and 3RT12 vacuum contactors)
(size S12: the same for air-break and vacuum contactors)
- ④ Withdrawable coils for 3RT1...-N.. contactors with solid-state operating mechanism.
(size S10: differentiation between 3RT10/3RT14 air-break contactors and 3RT12 vacuum contactors)
(size S12: the same for air-break and vacuum contactors)
- ⑤ Withdrawable coils and laterally mountable module (plug-on) for 3RT1...-P.. and 3RT1...-Q.. air-break contactors with solid-state operating mechanism and remaining lifetime indicator
- ⑥ Surge suppressor (RC element) (page 3/119), plug-mountable on withdrawable coils
 - 3RT1...-A.. with conventional operating mechanism.
 - 3RT1...-N.. with solid-state operating mechanism.

- ① Identical for sizes S6 to S12
- ② Different according to size

For mountable overload relays see Protection Equipment: Overload Relays

3RT, 3TB, 3TF Contactors for Switching Motors

3RT10 contactors, 3-pole, 3 ... 250 kW

Overview

3RT10 contactors, 3-pole, sizes S00 to S3, up to 45 kW

AC and DC operation

IEC 60947, EN 60947 (VDE 0660)

The 3RT1 contactors are climate-proof. They are finger-safe according to EN 50274.

The 3RT1 contactors are available with screw terminals or with Cage Clamp terminals.

Size S00 contactors have an auxiliary contact integrated in the basic unit. The basic units of sizes S0 to S3 contain only the main circuits.

All basic units can be extended with auxiliary switch blocks. For size S0 and higher, complete units with 2 NO + 2 NC are available (connection designation according to EN 50012). The auxiliary switch block can be removed (*for more information see LV 1 T*).

In addition, complete units with permanently mounted auxiliary switch block (2 NO + 2 NC according to EN 50012) are offered for sizes S00 and S0. These versions are built according to special Swiss regulations "SUVA" and are distinguished externally by a red identification plate.

The size S3 contactors have removable box terminals for the main conductor connections. This permits connection of ring terminal lugs or busbars.

Contact reliability

If voltages ≤ 110 V and currents ≤ 100 mA are to be switched, the auxiliary contacts of the 3RT1 contactor or 3RH11 contactor relay should be used as they guarantee a high level of contact reliability.

These auxiliary contacts are suitable for electronic circuits with currents ≥ 1 mA at a voltage of 17 V.

Short circuit protection of the contactors

For more information about short circuit protection of contactors without overload relay, see Technical Specifications. For more information about short circuit protection of the contactors with overload relay, see "Overload Relays". When installing fuseless motor feeders, the combinations of circuit-breakers and contactors described under "Fuseless Load Feeders" must be used.

Motor protection

3RU11 thermal overload relays or 3RB20 solid-state overload relays can be fitted to the 3RT1 contactors for protection against overload. The overload relays must be ordered separately.

Overvoltage damping

3RT1 contactors can be retrofitted with RC elements, varistors, diodes or diode assemblies (assembly of diode and Zener diode for short tripping times) for suppressing opening surges in the coil.

The surge suppressors are plugged onto the front of size S00 contactors. Space is provided for them next to a snap-on auxiliary switch block.

For size S0 to S3 contactors, varistors and RC elements can be snapped on either on the top or directly below the coil connections. Diode assemblies are available in 2 different versions on account of their polarity. Depending on the application they can be connected either only at the bottom (assembly with circuit-breaker) or only at the top (assembly with overload relay).

The plug-in direction of the diodes and diode assemblies is specified by coding.

Exceptions:

3RT19 26-1T.00 and

3RT19 36-1T.00; the plug-in direction is indicated here with "+" and "-".

Coupling relays are supplied either without overvoltage damping or with a varistor or diode connected as standard, according to the version.

Note:

The OFF-delay times of the NO contacts and the ON-delay times of the NC contacts increase if the contactor coils are damped against voltage peaks (noise suppression diode 6 to 10 times; diode assemblies 2 to 6 times, varistor +2 to 5 ms).

3RT10 contactors, 3-pole, sizes S6 to S12, > 45 to 250 kW

- 3RT10, contactors for switching motors,
- 3RT12, vacuum contactors for switching motors,
- 3RT14, contactors for AC-1 applications.

Operating mechanism types

Two types of solenoid operation are available:

- Conventional operating mechanism
- Solid-state operating mechanism (with 3 performance levels)

UC operation

The contactors can be operated with AC (40 to 60 Hz) as well as with DC.

Withdrawable coils

For simple coil replacement, e.g. if the application is replaced, the magnetic coil can be pulled out upwards after the release mechanism has been actuated and can be replaced by any other coil of the same size.

Auxiliary contact complement

The contactors can be fitted with up to 8 auxiliary contacts (identical auxiliary switch blocks from S0 to S12). Of these, no more than 4 are permitted to be NC contacts.

3RT10 and 3RT14 contactors:

Auxiliary contacts mounted laterally and on front

3RT12 vacuum contactors:

Auxiliary contacts mounted laterally

Contactors with conventional operating mechanism

Version 3RT1...-A:

The magnetic coil is switched directly on and off with the control supply voltage U_s by way of terminals A1/A2.

Multi-voltage range for the control supply voltage U_s :

A single coil covers several control supply voltages of similar ranges which are used worldwide, e.g. UC 110-115-120-127 V or UC 220-230-240 V.

In addition, allowance is also made for a coil operating range of 0.8 times the lower ($U_{s\ min}$) and 1.1 times the upper ($U_{s\ max}$) rated control supply voltage within which the contactor switches reliably and no thermal overloading occurs.

3RT, 3TB, 3TF Contactors for Switching Motors

3RT10 contactors, 3-pole, 3 ... 250 kW

Contactors with solid-state operating mechanism

The magnetic coil is supplied selectively with the power required for reliable switching and holding by series-connected control electronics.

- **Wide voltage range for the control supply voltage U_s :**
Compared with the conventional operating mechanism, the solid-state operating mechanism covers an even broader range of control supply voltages used worldwide within one coil variant. For example, the coil for UC 200 to 277 V ($U_{s \min}$ to $U_{s \max}$) covers the voltages 200-208-220-230-240-254-277 V used worldwide.
- **Extended operating range 0.7 to 1.25 x U_s :**
The wide range for the rated control supply voltage and the additionally allowed coil operating range of $0.8 \times U_{s \min}$ to $1.1 \times U_{s \max}$ results in an extended coil operating range of at least 0.7 to 1.25 x U_s , within which the contactors will operate reliably, for the most common control supply voltages of 24, 110 and 230 V.
- **Bridging temporary voltage dips:**
Control voltage failures dipping to 0 V (at A1/A2) are bridged for up to approx. 25 ms to avoid unintentional tripping.
- **Defined ON and OFF thresholds:**
For voltages of $\geq 0.8 \times U_{s \min}$ and higher the electronics will reliably switch the contactor ON, and as of $\leq 0.5 \times U_{s \min}$ it is reliably switched off. The differential travel in the switching thresholds prevents the main contacts from chattering as well as increased wear or welding when operated in weak, unstable networks. This also prevents thermal overloading of the contactor coil if the voltage applied is too low (contactor does not close properly and is continuously operated with overexcitation).
- **Low control power consumption when closing and in the closed state.**

Electromagnetic compatibility (EMC)

The contactors with solid-state operating mechanism comply with the requirements for operation in industrial installations.

- Interference immunity
 - Burst (IEC 61000-4-4): 4 kV
 - Surge (IEC 61000-4-5): 4 kV
 - Electrostatic discharge, ESD (IEC 61000-4-2): 8/15 kV
 - Electromagnetic field (IEC 61000-4-3): 10 V/m
- Emitted interference
 - Limit value class A according to EN 55011

Note:

When used with converters, the control cables must be routed separately from the load cables of the converter.

Indication of remaining lifetime (RLT)

Main contactor contacts are working parts which must be replaced in good time when the end of their service life has been reached. The degree of contact erosion and thus the electrical endurance (= number of operating cycles) depends on the loading, utilization category, duty type, etc. Routine checks/visual inspections by the service personnel are needed in order to monitor the state of the main contacts. The "remaining lifetime indication" function takes over this task. It does not count the number of operating cycles – which does not provide information about contact erosion – but instead electronically identifies, evaluates and stores the actual progress of erosion of each one of the three main contacts, and outputs a warning when specified limits are reached. The stored data are not lost even if the control supply voltage for A1/A2 fails. After replacement of the main contacts, measurement the remaining lifetime must be reset using the "RESET" button (hold down RESET button for about 2 seconds using a pen or similar tool).

Advantages:

- Signaling through relay contact or AS-i when remaining lifetime is 20 %, i.e. contact material wear is 80 %
- Additional visual indication of various levels of erosion by means of LEDs on the laterally mounted solid-state module when remaining lifetime is 60 % (green), 40 % (orange) and 20 % (red)

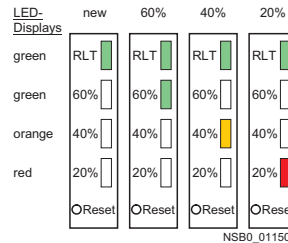

- Early warning to replace contacts
- Optimum utilization of contact material
- Visual inspection of the condition of contacts no longer necessary
- Reduction of ongoing operating costs
- Optimum planning of maintenance measures
- Avoidance of unforeseen plant downtimes

3RT1. ...-N version: for 24 V DC PLC output

2 control options:

- Control without an interface directly through a 24 V DC/ ≥ 30 mA PLC output (EN 61131-2). Connection by means of 2-pole plug-in connection. The screwless spring-operated connector is part of the scope of supply. The control supply voltage which supplies the solenoid operating mechanism must be connected to A1/A2.

Note:

Set the slide switch for PLC operation to "PLC ON" before commissioning (factory setting: "PLC OFF").

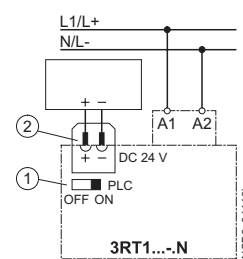

- ① Slide switch must be in "PLC ON" position
- ② Plug-in connection, 2-pole

- Conventional control by applying the control supply voltage at A1/A2 through a switching contact.

Note:

Slide switch must be in "PLC OFF" position (= factory setting).

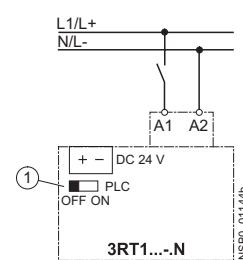

- ① Slide switch must be in "PLC OFF" position

3RT, 3TB, 3TF Contactors for Switching Motors

3RT10 contactors, 3-pole, 3 ... 250 kW

3RT1...-P version: for 24 V DC PLC output or PLC relay output, with indication of remaining lifetime (RLT)

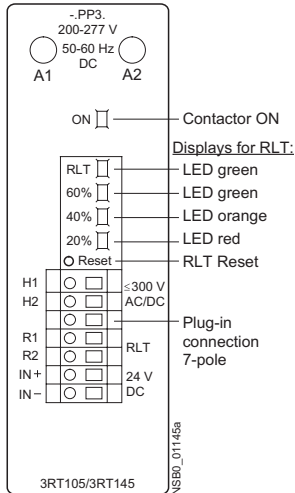

To supply the solenoid and the remaining lifetime indicator with power, the control supply voltage U_s must be connected to terminals A1/A2 of the laterally mounted solid-state module. The control inputs of the contactor are connected to a 7-pole plug-in connection; the screwless spring-operated connector is part of the scope of supply.

- The "Remaining lifetime (RLT)" status signal is available at terminals R1/R2 through a floating relay contact (hard gold-plated, enclosed) and can be input to SIMOCODE, PLC or other devices for processing, for example. Permissible current-carrying capacity of the R1/R2 relay output:
 - I_e/AC -15/24 to 230 V: 3 A
 - I_e/DC -13/24 V: 1 A
- LED indicators
The following states are indicated by means of LEDs on the laterally mounted solid-state module:
 - Contactor ON (energized state): Green LED ("ON")
 - Indication of remaining lifetime

2 control options:

- Contactor control without an interface directly through a 24 V DC ≥ 30 mA PLC output (EN 61131-2) by way of terminals IN+/IN-.

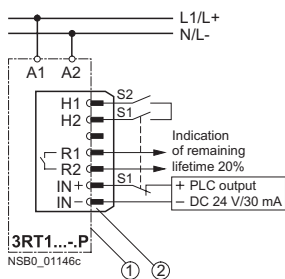

- Solid-state module of 3RT1...-P contactor
 - Plug-in connection, 7-pole
- S1 Selector switch for switching from automatic control through PLC semiconductor output to local control
- S2 Local control option

Possibility of switching from automatic control to local control by way of terminals H1/H2, i.e. automatic control through PLC or SIMOCODE/PROFIBUS DP can be deactivated e.g. at startup or in the event of a fault and the contactor can be controlled manually.

- Contactor control through relay outputs, e.g. by
 - PLC
 - SIMOCODE

by way of terminals H1/H2. Contact loading: $U_s/\text{approx. } 5 \text{ mA}$. When operated through SIMOCODE, a communication link to PROFIBUS DP is also provided.

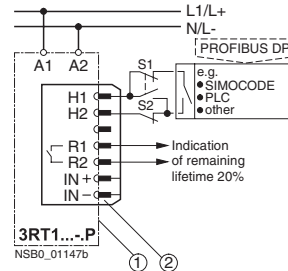

- Solid-state module of 3RT1...-P contactor
 - Plug-in connection, 7-pole
- S1 Selector switch for switching from automatic control, e.g. by means of SIMOCODE-DP or PLC relay output, to local control
- S2 Local control option

3RT1...-Q version: communication-capable with integrated AS-Interface and indication of remaining lifetime (RLT)

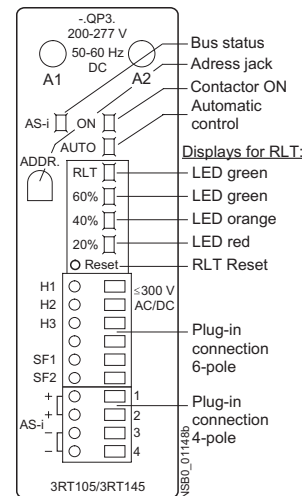

To supply the solenoid and the remaining lifetime indicator with power, the control supply voltage U_s must be connected to terminals A1/A2 of the laterally mounted solid-state module. The contactor itself is controlled by way of the integrated AS-Interface interface. The inputs and outputs are connected to a 10-pole plug-in connection; the screwless spring-operated connectors (6-pole for external connection and 4-pole for AS-Interface connection) are part of the scope of supply.

- LED indicators:
The following states are indicated by means of LEDs on the laterally mounted solid-state module:
 - Contactor ON (energized state): Green LED ("ON")
 - Automatic/Local control: Green LED ("AUTO")
 - Bus status: Green/red dual LED ("AS-i")
 - Remaining lifetime (RLT)
- AS-Interface addressing socket "ADDR":
The contactor address can be assigned after installation.

3RT, 3TB, 3TF Contactors for Switching Motors

3RT10 contactors, 3-pole, 3 ... 250 kW

Control circuit:

- Contactor control through AS-Interface by way of terminals AS-i +/AS-i -. Each of these terminals is jumpered and connected twice to a 4-pole connector which is separate from the other control inputs.
- Advantages:
 - The AS-Interface cable is not interrupted if the connector is pulled out
 - The contactor remains functional through the local control inputs and its own 6-pole connector
- Control signals through AS-i:
 - Contactor ON/OFF
- Status signals through AS-i:
 - Contactor ON/OFF
 - Automatic/Local control:
 - Remaining lifetime (RLT)
 - Signal through free input, e.g. overload relay tripped.

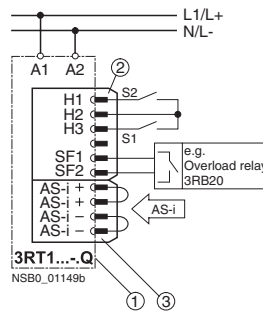

- ① Solid-state module of 3RT1 ...-Q contactor
 - ② Plug-in connection, 6-pole
 - ③ Plug-in connection, 4-pole
- S1 Selector switch for switching from automatic control, e.g. by means of AS-Interface, to local control
S1 open: Automatic mode
S2 Local control option

Possibility of switching from automatic control to local control by means of terminals H1/H2/H3, i.e. automatic control through AS-Interface can be deactivated e.g. during startup or in the event of a fault and the contactor can be controlled manually.

I/O configuration (hex)	7
ID code (hex)	F
Power supply	V 26.5 ... 31.6 (according to AS-Interface specification)
AS-Interface current input	mA max. 20
Contact loading at SF1/2	mA 3 ... 6
Watchdog function (disconnects outputs in the event of AS-Interface fault)	Built-in

Indication behavior

During operation, the LEDs on the contactor indicate the states shown on the right.

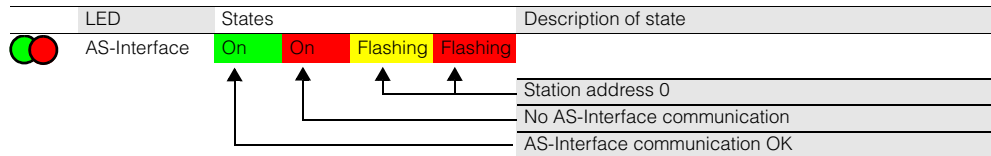

Contactor diagnostics using the application program

• Inputs

Input signals	Device status
D10 "Ready"	0 Device not ready/manual operation 1 Device ready/automatic operation
D11 "Running"	0 Contactor off 1 Contactor on
D12 "Remaining lifetime"	0 Remaining lifetime RLT > 20 % 1 Remaining lifetime RLT ≤ 20 %
D13 "Free input"	0 No input signal at SF1/2 1 Input signal at SF1/2

• Outputs

Output signals	Device status
DO0 "Running"	0 Contactor off 1 Contactor on
DO1	0 -- 1 --
DO2	0 -- 1 --
DO3	0 -- 1 --

3RT, 3TB, 3TF Contactors for Switching Motors

3RT10 contactors, 3-pole, 3 ... 250 kW

Selection and ordering data

AC operation
Screw terminals



3RT10 1.-1A...

3RT10 1.-1AP04-3MA0

Rated data		Auxiliary contacts		Rated control supply voltage U_c at 50/60 Hz	DT	Screw terminals	PU (UNIT, SET, M)	PS*	PG	Weight per PU approx.
AC-2 and AC-3, T_U : up to 60 °C	AC-1, T_U : 40 °C	Operational current I_e up to 400 V	Rating of induction motors at 50 Hz and up to 400 V	Operational current I_e up to 690 V	Ident. No.	Version No.	Order No.			
A	A	kW			NO	NC	Price per PU			kg

For screw and snap-on mounting onto 35 mm standard mounting rail

Size S00¹⁾

Terminal designations according to EN 50012

7	3	18	10 E	1	--	24	▶	3RT10 15-1AB01	1	1 unit	101	0.205
						110	▶	3RT10 15-1AF01	1	1 unit	101	0.203
						230	▶	3RT10 15-1AP01	1	1 unit	101	0.203
01	--	1	24	▶	3RT10 15-1AB02	110	▶	3RT10 15-1AF02	1	1 unit	101	0.203
						230	▶	3RT10 15-1AP02	1	1 unit	101	0.204
						24	▶	3RT10 16-1AB01	1	1 unit	101	0.204
9	4	22	10 E	1	--	110	▶	3RT10 16-1AF01	1	1 unit	101	0.205
						230	▶	3RT10 16-1AP01	1	1 unit	101	0.200
						24	▶	3RT10 16-1AB02	1	1 unit	101	0.206
01	--	1	110	▶	3RT10 16-1AF02	230	▶	3RT10 16-1AP02	1	1 unit	101	0.205
						24	▶	3RT10 17-1AB01	1	1 unit	101	0.204
						110	▶	3RT10 17-1AF01	1	1 unit	101	0.203
12	5.5	22	10 E	1	--	230	▶	3RT10 17-1AP01	1	1 unit	101	0.204
						24	▶	3RT10 17-1AB02	1	1 unit	101	0.204
						110	▶	3RT10 17-1AF02	1	1 unit	101	0.203
01	--	1	230	▶	3RT10 17-1AP02	24	▶	3RT10 17-1AB01	1	1 unit	101	0.204
						110	▶	3RT10 17-1AF01	1	1 unit	101	0.203
						230	▶	3RT10 17-1AP01	1	1 unit	101	0.204
01	--	1	24	▶	3RT10 17-1AB02	110	▶	3RT10 17-1AF02	1	1 unit	101	0.203
						230	▶	3RT10 17-1AP02	1	1 unit	101	0.204

Size S00¹⁾

With permanently mounted auxiliary switch block

Terminal designations according to EN 50012

7	3	18	22 E	2	2	230	▶	3RT10 15-1AP04-3MA0	1	1 unit	101	0.245
9	4	22	22 E	2	2	230	▶	3RT10 16-1AP04-3MA0	1	1 unit	101	0.245
12	5.5	22	22 E	2	2	230	▶	3RT10 17-1AP04-3MA0	1	1 unit	101	0.245

For other voltages, see page 3/29.

For accessories, see page 3/110.

For multi-unit packing and reusable packaging, see Appendix -> Ordering Notes.

- 1) For size S00: Coil operating range
at 50 Hz: 0.8 ... 1.1 x U_{S_1}
at 60 Hz: 0.85 ... 1.1 x U_{S_1}

3RT, 3TB, 3TF Contactors for Switching Motors

3RT10 contactors, 3-pole, 3 ... 250 kW

AC operation Cage Clamp terminals



3RT10 1.-2A...



3RT10 1.-2AP04-3MA0

Rated data		AC-1, T_U : 40 °C	Auxiliary contacts		Rated control supply voltage U_s at 50/60 Hz	DT	Cage Clamp terminal	PU (UNIT, SET, M)	PS*	PG	Weight per PU approx.
Operational current I_e up to 400 V	Rating of induction motors at 50 Hz and 400 V	Operational current I_e up to 690 V	Ident. No.	Version	V	AC	Order No.	Price per PU			kg
A	400 V kW	A	NO	NC	V	AC					

For screw and snap-on mounting onto 35 mm standard mounting rail

Size S00¹⁾

Terminal designations according to EN 50012

7	3	18	10 E	1	--	24	▶	3RT10 15-2AB01	1	1 unit	101	0.203
						110	▶	3RT10 15-2AF01	1	1 unit	101	0.200
						230	▶	3RT10 15-2AP01	1	1 unit	101	0.201
	01	--	1	24	▶	24	▶	3RT10 15-2AB02	1	1 unit	101	0.201
						110	▶	3RT10 15-2AF02	1	1 unit	101	0.201
						230	▶	3RT10 15-2AP02	1	1 unit	101	0.201
9	4	22	10 E	1	--	24	▶	3RT10 16-2AB01	1	1 unit	101	0.203
						110	▶	3RT10 16-2AF01	1	1 unit	101	0.201
						230	▶	3RT10 16-2AP01	1	1 unit	101	0.201
	01	--	1	24	▶	24	▶	3RT10 16-2AB02	1	1 unit	101	0.201
						110	▶	3RT10 16-2AF02	1	1 unit	101	0.200
						230	▶	3RT10 16-2AP02	1	1 unit	101	0.201
12	5.5	22	10 E	1	--	24	▶	3RT10 17-2AB01	1	1 unit	101	0.201
						110	▶	3RT10 17-2AF01	1	1 unit	101	0.199
						230	▶	3RT10 17-2AP01	1	1 unit	101	0.199
	01	--	1	24	▶	24	▶	3RT10 17-2AB02	1	1 unit	101	0.202
						110	▶	3RT10 17-2AF02	1	1 unit	101	0.200
						230	▶	3RT10 17-2AP02	1	1 unit	101	0.201

Size S00¹⁾

With permanently mounted auxiliary switch block

Terminal designations according to EN 50012

7	3	18	22 E	2	2	230	B	3RT10 15-2AP04-3MA0	1	1 unit	101	0.248
9	4	22	22 E	2	2	230	B	3RT10 16-2AP04-3MA0	1	1 unit	101	0.240
12	5.5	22	22 E	2	2	230	B	3RT10 17-2AP04-3MA0	1	1 unit	101	0.247

For other voltages, see page 3/29.

For accessories, see page 3/110.

For multi-unit packing and reusable packaging, see Appendix -> Ordering Notes.

1) For size S00: Coil operating range
at 50 Hz: 0.8 ... 1.1 x U_s ,
at 60 Hz: 0.85 ... 1.1 x U_s .

3RT, 3TB, 3TF Contactors for Switching Motors

3RT10 contactors, 3-pole, 3 ... 250 kW

AC operation Screw terminals



3RT10 2.-1A.00



3RT10 2.-1A.04



3RT10 2.-1AL24-3MA0

Rated data		Auxiliary contacts		Rated control supply voltage U_s at 50 Hz	DT	Screw terminals	PU (UNIT, SET, M)	PS*	PG	Weight per PU approx.
AC-2 and AC-3, T_U : up to 60 °C	AC-1, T_U : 40 °C					Order No.				
Operational current I_e up to 400 V	Rating of induction motors at 50 Hz and 400 V	Operational current I_e up to 690 V	Ident. No.	Version		Price per PU				kg
A	kW	A	NO	NC	V AC					

For screw and snap-on mounting onto 35 mm standard mounting rail

Size S0

9	4	40 ¹⁾	--	--	--	24	▶	3RT10 23-1AB00	1	1 unit	101	0.339
						110	▶	3RT10 23-1AF00	1	1 unit	101	0.338
						230	▶	3RT10 23-1AP00	1	1 unit	101	0.337
12	5.5	40 ¹⁾	--	--	--	24	▶	3RT10 24-1AB00	1	1 unit	101	0.338
						110	▶	3RT10 24-1AF00	1	1 unit	101	0.337
						230	▶	3RT10 24-1AP00	1	1 unit	101	0.339
17	7.5	40 ¹⁾	--	--	--	24	▶	3RT10 25-1AB00	1	1 unit	101	0.341
						110	▶	3RT10 25-1AF00	1	1 unit	101	0.336
						230	▶	3RT10 25-1AP00	1	1 unit	101	0.339
25	11	40 ¹⁾	--	--	--	24	▶	3RT10 26-1AB00	1	1 unit	101	0.340
						110	▶	3RT10 26-1AF00	1	1 unit	101	0.336
						230	▶	3RT10 26-1AP00	1	1 unit	101	0.339

Size S0

With mounted auxiliary switch block (removable)

Terminal designations according to EN 50012

9	4	40 ¹⁾	22 E	2	2	24	▶	3RT10 23-1AB04	1	1 unit	101	0.407
						110	▶	3RT10 23-1AF04	1	1 unit	101	0.406
						230	▶	3RT10 23-1AP04	1	1 unit	101	0.409
12	5.5	40 ¹⁾	22 E	2	2	24	▶	3RT10 24-1AB04	1	1 unit	101	0.409
						110	▶	3RT10 24-1AF04	1	1 unit	101	0.405
						230	▶	3RT10 24-1AP04	1	1 unit	101	0.408
17	7.5	40 ¹⁾	22 E	2	2	24	▶	3RT10 25-1AB04	1	1 unit	101	0.411
						110	▶	3RT10 25-1AF04	1	1 unit	101	0.410
						230	▶	3RT10 25-1AP04	1	1 unit	101	0.407
25	11	40 ¹⁾	22 E	2	2	24	▶	3RT10 26-1AB04	1	1 unit	101	0.410
						110	▶	3RT10 26-1AF04	1	1 unit	101	0.406
						230	▶	3RT10 26-1AP04	1	1 unit	101	0.408

Size S0

With permanently mounted auxiliary switch block

Terminal designations according to EN 50012

12	5.5	40 ¹⁾	22 E	2	2	230	B	3RT10 24-1AL24-3MA0	1	1 unit	101	0.415
17	7.5	40 ¹⁾	22 E	2	2	230	A	3RT10 25-1AL24-3MA0	1	1 unit	101	0.415
25	11	40 ¹⁾	22 E	2	2	230	A	3RT10 26-1AL24-3MA0	1	1 unit	101	0.415

For other voltages, see page 3/29.

For accessories, see page 3/112.

For spare parts, see page 3/126.

For multi-unit packing and reusable packaging, see Appendix -> Ordering Notes.

1) Minimum conductor cross-section 10 mm².

3RT, 3TB, 3TF Contactors for Switching Motors

3RT10 contactors, 3-pole, 3 ... 250 kW

AC operation Cage Clamp terminals



3RT10 2.-3A.00

Rated data		AC-1, T_U : 40 °C	Auxiliary contacts		Rated control supply voltage U_s at 50 Hz	DT	Cage Clamp terminals for coil connections		PU (UNIT, SET, M)	PS*	PG	Weight per PU approx.
AC-2 and AC-3, T_U : up to 60 °C	Operational current I_e up to		Rating of induction motors at 50 Hz and	Operational current I_e up to			Ident. No.	Version				
400 V	400 V	690 V										kg
A	kW	A		NO	NC	V AC						
For screw and snap-on mounting onto 35 mm standard mounting rail												
Size S0												
9	4	40 ¹⁾	--	--	--	24 110 230	B B ▶	3RT10 23-3AB00 3RT10 23-3AF00 3RT10 23-3AP00	1 1 1	1 unit 1 unit 1 unit	101 101 101	0.335 0.335 0.334
12	5.5	40 ¹⁾	--	--	--	24 110 230	B B ▶	3RT10 24-3AB00 3RT10 24-3AF00 3RT10 24-3AP00	1 1 1	1 unit 1 unit 1 unit	101 101 101	0.335 0.333 0.335
17	7.5	40 ¹⁾	--	--	--	24 110 230	B B ▶	3RT10 25-3AB00 3RT10 25-3AF00 3RT10 25-3AP00	1 1 1	1 unit 1 unit 1 unit	101 101 101	0.335 0.335 0.336
25	11	40 ¹⁾	--	--	--	24 110 230	B B ▶	3RT10 26-3AB00 3RT10 26-3AF00 3RT10 26-3AP00	1 1 1	1 unit 1 unit 1 unit	101 101 101	0.337 0.338 0.337

For other voltages, see page 3/29.

For accessories, see page 3/112.

For spare parts, see page 3/126.

For multi-unit packing and reusable packaging, see Appendix -> Ordering Notes.

1) Minimum conductor cross-section 10 mm².

3RT, 3TB, 3TF Contactors for Switching Motors

3RT10 contactors, 3-pole, 3 ... 250 kW

AC operation Screw terminals



3RT10 3.-1A.00



3RT10 3.-1A.04

Rated data		Auxiliary contacts		Rated control supply voltage U_s at 50 Hz	DT	Screw terminals	PU (UNIT, SET, M)	PS*	PG	Weight per PU approx.
AC-2 and AC-3, T_U : up to 60 °C	AC-1, T_U : 40 °C	Operational current I_e up to 500 V	Rating of induction motors at 50 Hz and 400 V	Operational current I_e up to 690 V	Ident. No.	Order No.				
A	kW	A			NO NC	Price per PU				kg

For screw and snap-on mounting onto 35 mm standard mounting rail

Size S2

32	15	50	--	--	--	24	▶	3RT10 34-1AB00	1	1 unit	101	0.810
						110	▶	3RT10 34-1AF00	1	1 unit	101	0.815
						230	▶	3RT10 34-1AP00	1	1 unit	101	0.813
40	18.5	60	--	--	--	24	▶	3RT10 35-1AB00	1	1 unit	101	0.838
						110	▶	3RT10 35-1AF00	1	1 unit	101	0.835
						230	▶	3RT10 35-1AP00	1	1 unit	101	0.839
50	22	60	--	--	--	24	▶	3RT10 36-1AB00	1	1 unit	101	0.841
						110	▶	3RT10 36-1AF00	1	1 unit	101	0.836
						230	▶	3RT10 36-1AP00	1	1 unit	101	0.838

Size S2

With mounted auxiliary switch block (removable)

Terminal designations according to EN 50012

32	15	50	22 E	2	2	24	▶	3RT10 34-1AB04	1	1 unit	101	0.908
						110	▶	3RT10 34-1AF04	1	1 unit	101	0.912
						230	▶	3RT10 34-1AP04	1	1 unit	101	0.908
40	18.5	60	22 E	2	2	24	▶	3RT10 35-1AB04	1	1 unit	101	0.931
						110	▶	3RT10 35-1AF04	1	1 unit	101	0.931
						230	▶	3RT10 35-1AP04	1	1 unit	101	0.930
50	22	60	22 E	2	2	24	▶	3RT10 36-1AB04	1	1 unit	101	0.929
						110	▶	3RT10 36-1AF04	1	1 unit	101	0.940
						230	▶	3RT10 36-1AP04	1	1 unit	101	0.929

For other voltages, see page 3/29.

For accessories, see page 3/112.

For spare parts, see page 3/126.

For multi-unit packing and reusable packaging, see Appendix -> Ordering Notes.

3RT, 3TB, 3TF Contactors for Switching Motors

3RT10 contactors, 3-pole, 3 ... 250 kW

AC operation
Cage Clamp terminals



3RT10 3.-3A.00

Rated data		Auxiliary contacts	Rated control supply voltage U_s at 50 Hz	DT	Cage Clamp terminals for coil connections	PU (UNIT, SET, M)	PS*	PG	Weight per PU approx.
AC-2 and AC-3, T_U : up to 60 °C	AC-1, T_U : 40 °C				Order No.	Price per PU			
Operational current I_e up to	Rating of induction motors at 50 Hz and	Operational current I_e up to	Ident. No.	Version					
A	400 V kW	A	V AC						kg

For screw and snap-on mounting onto 35 mm standard mounting rail

Size S2

32	15	50	--	--	--	24	B	3RT10 34-3AB00	1	1 unit	101	0.808
			--	--	--	110	B	3RT10 34-3AF00	1	1 unit	101	0.815
			--	--	--	230	▶	3RT10 34-3AP00	1	1 unit	101	0.811
40	18.5	60	--	--	--	24	B	3RT10 35-3AB00	1	1 unit	101	0.836
			--	--	--	110	B	3RT10 35-3AF00	1	1 unit	101	0.837
			--	--	--	230	▶	3RT10 35-3AP00	1	1 unit	101	0.834
50	22	60	--	--	--	24	B	3RT10 36-3AB00	1	1 unit	101	0.839
			--	--	--	110	B	3RT10 36-3AF00	1	1 unit	101	0.831
			--	--	--	230	▶	3RT10 36-3AP00	1	1 unit	101	0.837

For other voltages, see page 3/29.

For accessories, see page 3/112.

For spare parts, see page 3/127.

For multi-unit packing and reusable packaging, see Appendix -> Ordering Notes.

3RT, 3TB, 3TF Contactors for Switching Motors

3RT10 contactors, 3-pole, 3 ... 250 kW

AC operation
Screw terminals



3RT10 4.-1A.00

Rated data		Auxiliary contacts		Rated control supply voltage U_s	DT	Screw terminals		PU (UNIT, SET, M)	PS*	PG	Weight per PU approx.
AC-2 and AC-3, T_U : up to 60 °C	AC-1, T_U : 40 °C	Operational current I_e up to	Rating of induction motors at 50 Hz and	Operational current I_e up to	Ident. No.	Version	Order No.	Price per PU			kg
A	kW	A			NO	NC					

For screw and snap-on mounting onto 35 mm and 75 mm standard mounting rail

Size S3

65	30	100	--	--	--	24	▶	3RT10 44-1AB00	1	1 unit	101	1.701
						110	▶	3RT10 44-1AF00	1	1 unit	101	1.709
						230	▶	3RT10 44-1AP00	1	1 unit	101	1.704
80	37	120	--	--	--	24	▶	3RT10 45-1AB00	1	1 unit	101	1.831
						110	▶	3RT10 45-1AF00	1	1 unit	101	1.830
						230	▶	3RT10 45-1AP00	1	1 unit	101	1.825
95	45	120	--	--	--	24	▶	3RT10 46-1AB00	1	1 unit	101	1.838
						110	▶	3RT10 46-1AF00	1	1 unit	101	1.829
						230	▶	3RT10 46-1AP00	1	1 unit	101	1.838

Size S3

With mounted auxiliary switch block (removable)

Terminal designations according to EN 50012

65	30	100	22 E	2	2	24	▶	3RT10 44-1AB04	1	1 unit	101	1.809
						110	▶	3RT10 44-1AF04	1	1 unit	101	1.805
						230	▶	3RT10 44-1AP04	1	1 unit	101	1.807
80	37	120	22 E	2	2	24	B	3RT10 45-1AB04	1	1 unit	101	1.930
						110	▶	3RT10 45-1AF04	1	1 unit	101	1.951
						230	▶	3RT10 45-1AP04	1	1 unit	101	1.935
95	45	120	22 E	2	2	24	B	3RT10 46-1AB04	1	1 unit	101	1.942
						110	▶	3RT10 46-1AF04	1	1 unit	101	1.960
						230	▶	3RT10 46-1AP04	1	1 unit	101	1.944

For other voltages, see page 3/29.

For accessories, see page 3/112.

For spare parts, see page 3/128.

3RT, 3TB, 3TF Contactors for Switching Motors

3RT10 contactors, 3-pole, 3 ... 250 kW

AC operation
Cage Clamp terminals



3RT10 4.-3A.00

Rated data		Auxiliary contacts		Rated control supply voltage U_s at 50 Hz		DT	Cage Clamp terminals for coil connections	PU (UNIT, SET, M)	PS*	PG	Weight per PU approx.	
AC-2 and AC-3, T_U : up to 60 °C	AC-1, T_U : 40 °C	Operational current I_e up to 500 V	Rating of induction motors at 50 Hz and 400 V	Operational current I_e up to 690 V	Ident. No.	Version	Order No.	Price per PU			kg	
A	kW	A			NO	NC						
For screw and snap-on mounting onto 35 mm and 75 mm standard mounting rail Size S3												
65	30	100	--	--	--	24 110 230	B B ▶	3RT10 44-3AB00 3RT10 44-3AF00 3RT10 44-3AP00	1 1 1	1 unit 1 unit 1 unit	101 101 101	1.720 1.715 1.695
80	37	120	--	--	--	24 110 230	B B ▶	3RT10 45-3AB00 3RT10 45-3AF00 3RT10 45-3AP00	1 1 1	1 unit 1 unit 1 unit	101 101 101	1.845 1.848 1.815
95	45	120	--	--	--	24 110 230	B B ▶	3RT10 46-3AB00 3RT10 46-3AF00 3RT10 46-3AP00	1 1 1	1 unit 1 unit 1 unit	101 101 101	1.854 1.843 1.840

For other voltages, see page 3/29.
For accessories, see page 3/112.
For spare parts, see page 3/129.

3RT, 3TB, 3TF Contactors for Switching Motors

3RT10 contactors, 3-pole, 3 ... 250 kW

DC operation · DC solenoid system
Screw terminals



3RT10 1.-1B...

Rated data		Auxiliary contacts		Rated control supply voltage U_c	DT	Screw terminals		PU (UNIT, SET, M)	PS*	PG	Weight per PU approx.
AC-2 and AC-3, T_U : up to 60 °C	AC-1, T_U : 40 °C	Operational current I_e up to 400 V	Rating of induction motors at 50 Hz and 400 V	Operational current I_e up to 690 V	Ident. No.	Version	Order No.	Price per PU			kg
A	kW	A			NO	NC	AC	V			

For screw and snap-on mounting onto 35 mm standard mounting rail

Size S00

Terminal designations according to EN 50012

7	3	18	10 E	1	--	24	▶	3RT10 15-1BB41	1	1 unit	101	0.263
						220	A	3RT10 15-1BM41	1	1 unit	101	0.260
			01	--	1	24	▶	3RT10 15-1BB42	1	1 unit	101	0.262
						220	B	3RT10 15-1BM42	1	1 unit	101	0.261
9	4	22	10 E	1	--	24	▶	3RT10 16-1BB41	1	1 unit	101	0.264
						220	B	3RT10 16-1BM41	1	1 unit	101	0.260
			01	--	1	24	▶	3RT10 16-1BB42	1	1 unit	101	0.263
						220	B	3RT10 16-1BM42	1	1 unit	101	0.261
12	5.5	22	10 E	1	--	24	▶	3RT10 17-1BB41	1	1 unit	101	0.263
						220	B	3RT10 17-1BM41	1	1 unit	101	0.259
			01	--	1	24	▶	3RT10 17-1BB42	1	1 unit	101	0.262
						220	B	3RT10 17-1BM42	1	1 unit	101	0.260

Size S00

With permanently mounted auxiliary switch block

Terminal designations according to EN 50012

7	3	18	22 E	2	2	24	▶	3RT10 15-1BB44-3MA0	1	1 unit	101	0.308
9	4	22	22 E	2	2	24	▶	3RT10 16-1BB44-3MA0	1	1 unit	101	0.309
12	5.5	22	22 E	2	2	24	▶	3RT10 17-1BB44-3MA0	1	1 unit	101	0.304

For other voltages, see page 3/29.

For accessories, see page 3/110.

For multi-unit packing and reusable packaging, see Appendix -> Ordering Notes.

3RT, 3TB, 3TF Contactors for Switching Motors

3RT10 contactors, 3-pole, 3 ... 250 kW

DC operation · DC solenoid system
Cage Clamp terminals



3RT10 1.-2B...

3RT10 1.-2BB44-3MA0

Rated data		AC-1, T_U : 40 °C	Auxiliary contacts	Rated control supply voltage U_s	DT	Cage Clamp terminals	PU (UNIT, SET, M)	PS*	PG	Weight per PU approx.
Operational current I_e up to	Rating of induction motors at 50 Hz and up to	Operational current I_e up to	Ident. No.	Version		Order No.	Price per PU			kg
400 V	400 V	690 V								
A	kW	A	NO	NC	V DC					

For screw and snap-on mounting onto
35 mm standard mounting rail

Size S00

Terminal designations according to EN 50012

7	3	18	10 E	1	--	24	▶	3RT10 15-2BB41		1	1 unit	101	0.260
							220	B	3RT10 15-2BM41		1	1 unit	101
			01	--	1	24	▶	3RT10 15-2BB42		1	1 unit	101	0.261
							220	B	3RT10 15-2BM42		1	1 unit	101
9	4	22	10 E	1	--	24	▶	3RT10 16-2BB41		1	1 unit	101	0.259
							220	B	3RT10 16-2BM41		1	1 unit	101
			01	--	1	24	▶	3RT10 16-2BB42		1	1 unit	101	0.261
							220	B	3RT10 16-2BM42		1	1 unit	101
12	5.5	22	10 E	1	--	24	▶	3RT10 17-2BB41		1	1 unit	101	0.261
							220	B	3RT10 17-2BM41		1	1 unit	101
			01	--	1	24	▶	3RT10 17-2BB42		1	1 unit	101	0.261
							220	B	3RT10 17-2BM42		1	1 unit	101

Size S00

With permanently mounted auxiliary switch block

Terminal designations according to EN 50012

7	3	18	22 E	2	2	24	B	3RT10 15-2BB44-3MA0		1	1 unit	101	0.308
9	4	22	22 E	2	2	24	A	3RT10 16-2BB44-3MA0		1	1 unit	101	0.308
12	5.5	22	22 E	2	2	24	B	3RT10 17-2BB44-3MA0		1	1 unit	101	0.308

For other voltages, see page 3/29.

For accessories, see page 3/110.

For multi-unit packing and reusable packaging, see Appendix -> Ordering Notes.

3RT, 3TB, 3TF Contactors for Switching Motors

3RT10 contactors, 3-pole, 3 ... 250 kW

DC operation · DC solenoid system
Screw terminals



3RT10 2.-1B0.40

3RT10 2.-1BB44-3MA0

Rated data		AC-1, T_{ij} : 40 °C	Auxiliary contacts		Rated control supply voltage U_s	DT	Screw terminals		PU (UNIT, SET, M)	PS*	PG	Weight per PU approx.
Operational current I_e up to 400 V	Rating of induction motors at 50 Hz and 400 V	Operational current I_e up to 690 V	Ident. No.	Version	V DC		Order No.	Price per PU				kg
A	400 V kW	A	NO	NC								

For screw and snap-on mounting onto 35 mm standard mounting rails

Size S0

9	4	40 ¹⁾	--	--	--	24 220	▶ B	3RT10 23-1BB40 3RT10 23-1BM40	1 1	1 unit 1 unit	101 101	0.570 0.576
12	5.5	40 ¹⁾	--	--	--	24 220	▶ A	3RT10 24-1BB40 3RT10 24-1BM40	1 1	1 unit 1 unit	101 101	0.566 0.579
17	7.5	40 ¹⁾	--	--	--	24 220	▶ A	3RT10 25-1BB40 3RT10 25-1BM40	1 1	1 unit 1 unit	101 101	0.570 0.575
25	11	40 ¹⁾	--	--	--	24 220	▶ A	3RT10 26-1BB40 3RT10 26-1BM40	1 1	1 unit 1 unit	101 101	0.569 0.580

Size S0

With mounted auxiliary switch block (removable)

Terminal designations according to EN 50012

9	4	40 ¹⁾	22 E	2	2	24 220	▶ B	3RT10 23-1BB44 3RT10 23-1BM44	1 1	1 unit 1 unit	101 101	0.639 0.644
12	5.5	40 ¹⁾	22 E	2	2	24 220	▶ B	3RT10 24-1BB44 3RT10 24-1BM44	1 1	1 unit 1 unit	101 101	0.641 0.645
17	7.5	40 ¹⁾	22 E	2	2	24 220	▶ B	3RT10 25-1BB44 3RT10 25-1BM44	1 1	1 unit 1 unit	101 101	0.640 0.645
25	11	40 ¹⁾	22 E	2	2	24 220	▶ B	3RT10 26-1BB44 3RT10 26-1BM44	1 1	1 unit 1 unit	101 101	0.643 0.645

Size S0

With permanently mounted auxiliary switch block

Terminal designations according to EN 50012

12	5.5	40 ¹⁾	22 E	2	2	24	A	3RT10 24-1BB44-3MA0	1	1 unit	101	0.641
17	7.5	40 ¹⁾	22 E	2	2	24	A	3RT10 25-1BB44-3MA0	1	1 unit	101	0.640
25	11	40 ¹⁾	22 E	2	2	24	A	3RT10 26-1BB44-3MA0	1	1 unit	101	0.642

For other voltages, see page 3/29.

For accessories, see page 3/112.

For multi-unit packing and reusable packaging, see Appendix -> Ordering Notes.

1) Minimum conductor cross-section 10 mm².

3RT, 3TB, 3TF Contactors for Switching Motors

3RT10 contactors, 3-pole, 3 ... 250 kW

DC operation · DC solenoid system
Cage Clamp terminals



3RT10 2.-3B.40

Rated data		Auxiliary contacts		Rated control supply voltage U_s		DT	Cage Clamp terminals		PU (UNIT, SET, M)	PS*	PG	Weight per PU approx.
AC-2 and AC-3, T_u : up to 60 °C	AC-1, T_u : 40 °C	Operational current I_e up to 400 V	Rating of induction motors at 50 Hz and 400 V	Operational current I_e up to 690 V	Ident. No.	Version	Order No.	Price per PU				kg
A	kW	A			NO	NC	V DC					
For screw and snap-on mounting onto 35 mm standard mounting rail												
Size S0												
9	4	40 ¹⁾	--	--	--	24	▶	3RT10 23-3BB40	1	1 unit	101	0.566
			--	--	--	220	B	3RT10 23-3BM40	1	1 unit	101	0.572
12	5.5	40 ¹⁾	--	--	--	24	▶	3RT10 24-3BB40	1	1 unit	101	0.568
			--	--	--	220	B	3RT10 24-3BM40	1	1 unit	101	0.570
17	7.5	40 ¹⁾	--	--	--	24	▶	3RT10 25-3BB40	1	1 unit	101	0.570
			--	--	--	220	B	3RT10 25-3BM40	1	1 unit	101	0.572
25	11	40 ¹⁾	--	--	--	24	▶	3RT10 26-3BB40	1	1 unit	101	0.569
			--	--	--	220	B	3RT10 26-3BM40	1	1 unit	101	0.575

For other voltages, see page 3/29.

For accessories, see page 3/112.

For multi-unit packing and reusable packaging, see Appendix -> Ordering Notes.

1) Minimum conductor cross-section 10 mm².

3RT, 3TB, 3TF Contactors for Switching Motors

3RT10 contactors, 3-pole, 3 ... 250 kW

DC operation · DC solenoid system
Screw terminals



3RT10 3.-1B.40

3RT10 4.-1B.40

3RT10 4.-1B.44

Rated data		Auxiliary contacts		Rated control supply voltage	DT	Screw terminals		PU (UNIT, SET, M)	PS*	PG	Weight per PU approx.
AC-2 and AC-3, T_U : up to 60 °C	AC-1, T_U : 40 °C	Operational current I_e up to 500 V	Ratings of induction motors at 50 Hz and 400 V	Operational current I_e up to 690 V	Ident. No.	Version No.	Order No.	Price per PU			kg
A	kW	A	NO	NC	V DC						

For screw and snap-on mounting onto 35 mm standard mounting rail

Size S2

32	15	50	--	--	--	24	▶	3RT10 34-1BB40	1	1 unit	101	1.433
						220	A	3RT10 34-1BM40	1	1 unit	101	1.446
40	18.5	60	--	--	--	24	▶	3RT10 35-1BB40	1	1 unit	101	1.443
						220	B	3RT10 35-1BM40	1	1 unit	101	1.439
50	22	60	--	--	--	24	▶	3RT10 36-1BB40	1	1 unit	101	1.435
						220	B	3RT10 36-1BM40	1	1 unit	101	1.444

Size S2

With mounted auxiliary switch block (removable)

Terminal designations according to EN 50012

32	15	50	22 E	2	2	24	▶	3RT10 34-1BB44	1	1 unit	101	1.530
						220	A	3RT10 34-1BM44	1	1 unit	101	1.530
40	18.5	60	22 E	2	2	24	▶	3RT10 35-1BB44	1	1 unit	101	1.522
						220	B	3RT10 35-1BM44	1	1 unit	101	1.523
50	22	60	22 E	2	2	24	▶	3RT10 36-1BB44	1	1 unit	101	1.533
						220	B	3RT10 36-1BM44	1	1 unit	101	1.508

For screw and snap-on mounting onto 35 mm and 75 mm standard mounting rail

Size S3

65	30	100	--	--	--	24	▶	3RT10 44-1BB40	1	1 unit	101	2.808
						220	B	3RT10 44-1BM40	1	1 unit	101	2.793
80	37	120	--	--	--	24	▶	3RT10 45-1BB40	1	1 unit	101	2.828
						220	B	3RT10 45-1BM40	1	1 unit	101	2.781
95	45	120	--	--	--	24	▶	3RT10 46-1BB40	1	1 unit	101	2.817
						220	B	3RT10 46-1BM40	1	1 unit	101	2.767

Size S3

With mounted auxiliary switch block (removable)

Terminal designations according to EN 50012

65	30	100	22 E	2	2	24	▶	3RT10 44-1BB44	1	1 unit	101	2.921
						220	B	3RT10 44-1BM44	1	1 unit	101	2.880
80	37	120	22 E	2	2	24	▶	3RT10 45-1BB44	1	1 unit	101	2.919
						220	B	3RT10 45-1BM44	1	1 unit	101	2.870
95	45	120	22 E	2	2	24	▶	3RT10 46-1BB44	1	1 unit	101	2.913
						220	B	3RT10 46-1BM44	1	1 unit	101	2.887

For other voltages, see page 3/29.

For accessories, see page 3/112.

For spare parts, see page 3/128.

For multi-unit packing and reusable packaging, see Appendix -> Ordering Notes.

3RT, 3TB, 3TF Contactors for Switching Motors

3RT10 contactors, 3-pole, 3 ... 250 kW

DC operation · DC solenoid system
Cage Clamp terminals



3RT10 3.-3B.40



3RT10 4.-3B.40

Rated data		Auxiliary contacts		Rated control supply voltage U_s		DT	Cage Clamp terminals		PU (UNIT, SET, M)	PS*	PG	Weight per PU approx.
AC-2 and AC-3, T_U : up to 60 °C	AC-1, T_U : 40 °C						Order No.	Price per PU				
Operational current I_e up to 500 V	Rating of induction motors at 50 Hz and 400 V kW	Operational current I_e up to 690 V	Ident. No.	Version No.								
A		A	NO	NC	V DC							
For screw and snap-on mounting onto 35 mm standard mounting rail												
Size S2												
32	15	50	--	--	--	24 220	▶ B	3RT10 34-3BB40 3RT10 34-3BM40	1 1	1 unit 1 unit	101 101	1.435 1.452
40	18.5	60	--	--	--	24 220	▶ B	3RT10 35-3BB40 3RT10 35-3BM40	1 1	1 unit 1 unit	101 101	1.426 1.454
50	22	60	--	--	--	24 220	▶ A	3RT10 36-3BB40 3RT10 36-3BM40	1 1	1 unit 1 unit	101 101	1.443 1.455
For screw and snap-on mounting onto 35 mm and 75 mm standard mounting rail												
Size S3												
65	30	100	--	--	--	24 220	▶ B	3RT10 44-3BB40 3RT10 44-3BM40	1 1	1 unit 1 unit	101 101	2.807 2.749
80	37	120	--	--	--	24 220	▶ B	3RT10 45-3BB40 3RT10 45-3BM40	1 1	1 unit 1 unit	101 101	2.807 2.770
95	45	120	--	--	--	24 220	▶ B	3RT10 46-3BB40 3RT10 46-3BM40	1 1	1 unit 1 unit	101 101	2.821 2.760

For other voltages, see page 3/29.

For accessories, see page 3/112.

For spare parts, see page 3/129.

For multi-unit packing and reusable packaging, see Appendix -> Ordering Notes.

3RT, 3TB, 3TF Contactors for Switching Motors

3RT10 contactors, 3-pole, 3 ... 250 kW

AC/DC operation (40 Hz to 60 Hz, DC)

Auxiliary and control conductors: screw terminals

Withdrawable coils

Integrated coil circuit (varistor)

Main conductors: bar connections, for 3RT10 54 (55 kW) box terminals¹⁾



3RT1. 5.

3RT1. 6.

3RT1. 7.

Size	Rated data						Auxiliary contacts, lateral		Rated control supply voltage U_s	DT	Screw terminals	PU (UNIT, SET, M)	PS*	PG	Weight per PU approx.
	AC-2 and AC-3, T_u : up to 60 °C						AC-1, T_u : 40 °C				Order No.	Price per PU			
	Operational current I_e up to	Ratings of induction motors at 50 Hz and				Operational current I_e up to	NO	NC	V AC/DC						kg
	A	230 V	400 V	500 V	690 V	690 V									
Conventional operating mechanism															
S6	115	37	55	75	110	160	2	2	110 ... 127 220 ... 240	▶	3RT10 54-1AF36 3RT10 54-1AP36	1 1	1 unit 1 unit	101 101	3.641 3.619
	150	45	75	90	132	185	2	2	110 ... 127 220 ... 240	▶	3RT10 55-6AF36 3RT10 55-6AP36	1 1	1 unit 1 unit	101 101	3.344 3.331
	185	55	90	110	160	215	2	2	110 ... 127 220 ... 240	▶	3RT10 56-6AF36 3RT10 56-6AP36	1 1	1 unit 1 unit	101 101	3.369 3.350
S10	225	55	110	160	200	275	2	2	110 ... 127 220 ... 240	▶	3RT10 64-6AF36 3RT10 64-6AP36	1 1	1 unit 1 unit	101 101	6.508 6.428
	265	75	132	160	250	330	2	2	110 ... 127 220 ... 240	▶	3RT10 65-6AF36 3RT10 65-6AP36	1 1	1 unit 1 unit	101 101	6.554 6.500
	300	90	160	200	250	330	2	2	110 ... 127 220 ... 240	▶	3RT10 66-6AF36 3RT10 66-6AP36	1 1	1 unit 1 unit	101 101	6.599 6.520
S12	400	132	200	250	400	430	2	2	110 ... 127 220 ... 240	▶	3RT10 75-6AF36 3RT10 75-6AP36	1 1	1 unit 1 unit	101 101	10.340 10.070
	500	160	250	355	400	610	2	2	110 ... 127 220 ... 240	▶	3RT10 76-6AF36 3RT10 76-6AP36	1 1	1 unit 1 unit	101 101	10.490 10.355
Solid-state operating mechanism · for 24 V DC PLC output															
S6	115	37	55	75	110	160	2	2	96 ... 127 200 ... 277	▶	3RT10 54-1NF36 3RT10 54-1NP36	1 1	1 unit 1 unit	101 101	3.630 3.950
	150	45	75	90	132	185	2	2	96 ... 127 200 ... 277	▶	3RT10 55-6NF36 3RT10 55-6NP36	1 1	1 unit 1 unit	101 101	3.325 3.325
	185	55	90	110	160	215	2	2	96 ... 127 200 ... 277	▶	3RT10 56-6NF36 3RT10 56-6NP36	1 1	1 unit 1 unit	101 101	3.335 3.334
S10	225	55	110	160	200	275	2	2	96 ... 127 200 ... 277	A	3RT10 64-6NF36 3RT10 64-6NP36	1 1	1 unit 1 unit	101 101	6.664 6.526
	265	75	132	160	250	330	2	2	96 ... 127 200 ... 277	A	3RT10 65-6NF36 3RT10 65-6NP36	1 1	1 unit 1 unit	101 101	6.711 6.600
	300	90	160	200	250	330	2	2	96 ... 127 200 ... 277	B A	3RT10 66-6NF36 3RT10 66-6NP36	1 1	1 unit 1 unit	101 101	6.720 6.600
S12	400	132	200	250	400	430	2	2	96 ... 127 200 ... 277	A	3RT10 75-6NF36 3RT10 75-6NP36	1 1	1 unit 1 unit	101 101	10.352 10.079
	500	160	250	355	400	610	2	2	96 ... 127 200 ... 277	A	3RT10 76-6NF36 3RT10 76-6NP36	1 1	1 unit 1 unit	101 101	10.501 10.235

For other voltages, see page 3/29.

For accessories, see page 3/112.

For spare parts, see page 3/130.

1) Alternatively the 3RT10 54-1 contactor (55 kW) can be supplied with bar connections instead of box terminals. Without additional charge. In the 8th position of the Order No. the "1" must be replaced with "6", e.g. 3RT10 54-6..

3RT, 3TB, 3TF Contactors for Switching Motors

3RT10 contactors, 3-pole, 3 ... 250 kW

AC/DC operation (40 Hz to 60 Hz, DC)

Auxiliary and control conductors: Cage Clamp terminals

Withdrawable coils

Integrated coil circuit (varistor)

Main conductors: bar connections, for 3RT10 54 (55 kW) box terminals¹⁾

Size	Rated data						Auxiliary contacts, lateral		Rated control supply voltage U_s	DT	Cage Clamp terminals		PU (UNIT, SET, M)	PS*	PG	Weight per PU approx.
	AC-2 and AC-3, T_U : up to 60 °C			AC-1, T_U : 40 °C			NO	NC			Order No.	Price per PU				
	Operational current I_e up to	Ratings of induction motors at 50 Hz and				Operational current I_e up to									kg	
	500 V	230 V	400 V	500 V	690 V	690 V	A		V AC/DC							
	A	kW	kW	kW	kW	A	NO	NC								
Conventional operating mechanism																
S6	115	37	55	75	110	160	2	2	110 ... 127 220 ... 240	B	3RT10 54-3AF36 3RT10 54-3AP36	1	1 unit	101	3.641	
	150	45	75	90	132	185	2	2	110 ... 127 220 ... 240	B	3RT10 55-2AF36 3RT10 55-2AP36	1	1 unit	101	3.344	
	185	55	90	110	160	215	2	2	110 ... 127 220 ... 240	B	3RT10 56-2AF36 3RT10 56-2AP36	1	1 unit	101	3.374	
S10	225	55	110	160	200	275	2	2	110 ... 127 220 ... 240	B	3RT10 64-2AF36 3RT10 64-2AP36	1	1 unit	101	6.508	
	265	75	132	160	250	330	2	2	110 ... 127 220 ... 240	B	3RT10 65-2AF36 3RT10 65-2AP36	1	1 unit	101	6.554	
	300	90	160	200	250	330	2	2	110 ... 127 220 ... 240	B	3RT10 66-2AF36 3RT10 66-2AP36	1	1 unit	101	6.599	
S12	400	132	200	250	400	430	2	2	110 ... 127 220 ... 240	B	3RT10 75-2AF36 3RT10 75-2AP36	1	1 unit	101	10.340	
	500	160	250	355	400	610	2	2	110 ... 127 220 ... 240	B	3RT10 76-2AF36 3RT10 76-2AP36	1	1 unit	101	10.490	
Solid-state operating mechanism - for 24 V DC PLC output																
S6	115	37	55	75	110	160	2	2	96 ... 127 200 ... 277	B	3RT10 54-3NF36 3RT10 54-3NP36	1	1 unit	101	3.630	
	150	45	75	90	132	185	2	2	96 ... 127 200 ... 277	B	3RT10 55-2NF36 3RT10 55-2NP36	1	1 unit	101	3.325	
	185	55	90	110	160	215	2	2	96 ... 127 200 ... 277	B	3RT10 56-2NF36 3RT10 56-2NP36	1	1 unit	101	3.335	
S10	225	55	110	160	200	275	2	2	96 ... 127 200 ... 277	B	3RT10 64-2NF36 3RT10 64-2NP36	1	1 unit	101	6.664	
	265	75	132	160	250	330	2	2	96 ... 127 200 ... 277	B	3RT10 65-2NF36 3RT10 65-2NP36	1	1 unit	101	6.711	
	300	90	160	200	250	330	2	2	96 ... 127 200 ... 277	B	3RT10 66-2NF36 3RT10 66-2NP36	1	1 unit	101	6.720	
S12	400	132	200	250	400	430	2	2	96 ... 127 200 ... 277	B	3RT10 75-2NF36 3RT10 75-2NP36	1	1 unit	101	10.352	
	500	160	250	355	400	610	2	2	96 ... 127 200 ... 277	B	3RT10 76-2NF36 3RT10 76-2NP36	1	1 unit	101	10.501	

For other voltages, see page 3/29.

For accessories, see page 3/112.

For spare parts, see page 3/131.

- 1) Alternatively the 3RT10 54-1 contactor (55 kW) can be supplied with bar connections instead of box terminals. Without additional charge. In the 8th position of the Order No. the "3" must be replaced with "2", e.g. 3RT10 54-2...

3RT, 3TB, 3TF Contactors for Switching Motors

3RT10 contactors, 3-pole, 3 ... 250 kW

AC/DC operation (40 Hz to 60 Hz, DC)

Auxiliary and control conductors: screw terminals

Withdrawable coils

Integrated coil circuit (varistor)

Main conductors: bar connections, for 3RT10 54 (55 kW) box terminals¹⁾

Remaining lifetime indication (RLT)



3RT10 56-6P



3RT10 56-6Q

Size	Rated data						Auxiliary contacts, lateral	Rated control supply voltage U_s	DT	Screw terminals		PU (UNIT, SET, M)	PS*	PG	Weight per PU approx.
	AC-2 and AC-3, T_U : up to 60 °C		AC-1, T_U : 40 °C		Operational current I_e up to	Ratings of induction motors at 50 Hz and				Operational current I_e up to	Order No.				
	500 V	230 V	400 V	500 V	690 V	690 V	A	NO	NC	V AC/DC					kg
Solid-state operating mechanism - for 24 V DC PLC output/ PLC relay output, with indication of remaining lifetime (RLT)															
S6	115	37	55	75	110	160	1	1	96 ... 127 200 ... 277	B B	3RT10 54-1PF35 3RT10 54-1PP35	1 1	1 unit 1 unit	101 101	4.200 4.440
	150	45	75	90	132	185	1	1	96 ... 127 200 ... 277	B B	3RT10 55-6PF35 3RT10 55-6PP35	1 1	1 unit 1 unit	101 101	3.875 3.884
	185	55	90	110	160	215	1	1	96 ... 127 200 ... 277	B B	3RT10 56-6PF35 3RT10 56-6PP35	1 1	1 unit 1 unit	101 101	3.913 4.093
S10	225	55	110	160	200	275	1	1	96 ... 127 200 ... 277	B B	3RT10 64-6PF35 3RT10 64-6PP35	1 1	1 unit 1 unit	101 101	5.700 6.960
	265	75	132	160	250	330	1	1	96 ... 127 200 ... 277	B B	3RT10 65-6PF35 3RT10 65-6PP35	1 1	1 unit 1 unit	101 101	7.203 7.004
	300	90	160	200	250	330	1	1	96 ... 127 200 ... 277	B B	3RT10 66-6PF35 3RT10 66-6PP35	1 1	1 unit 1 unit	101 101	4.852 7.050
S12	400	132	200	250	400	430	1	1	96 ... 127 200 ... 277	B B	3RT10 75-6PF35 3RT10 75-6PP35	1 1	1 unit 1 unit	101 101	10.781 10.505
	500	160	250	355	400	610	1	1	96 ... 127 200 ... 277	B B	3RT10 76-6PF35 3RT10 76-6PP35	1 1	1 unit 1 unit	101 101	9.100 10.665
Solid-state operating mechanism - with AS-Interface and indication of remaining lifetime (RLT)															
S6	115	37	55	75	110	160	1	1	96 ... 127 200 ... 277	B B	3RT10 54-1QF35 3RT10 54-1QP35	1 1	1 unit 1 unit	101 101	4.190 4.167
	150	45	75	90	132	185	1	1	96 ... 127 200 ... 277	B B	3RT10 55-6QF35 3RT10 55-6QP35	1 1	1 unit 1 unit	101 101	3.892 3.886
	185	55	90	110	160	215	1	1	96 ... 127 200 ... 277	B B	3RT10 56-6QF35 3RT10 56-6QP35	1 1	1 unit 1 unit	101 101	3.100 3.888
S10	225	55	110	160	200	275	1	1	96 ... 127 200 ... 277	B B	3RT10 64-6QF35 3RT10 64-6QP35	1 1	1 unit 1 unit	101 101	7.018 6.930
	265	75	132	160	250	330	1	1	96 ... 127 00 ... 277	B B	3RT10 65-6QF35 3RT10 65-6QP35	1 1	1 unit 1 unit	101 101	5.700 7.000
	300	90	160	200	250	330	1	1	96 ... 127 200 ... 277	B B	3RT10 66-6QF35 3RT10 66-6QP35	1 1	1 unit 1 unit	101 101	5.700 7.018
S12	400	132	200	250	400	430	1	1	96 ... 127 200 ... 277	B B	3RT10 75-6QF35 3RT10 75-6QP35	1 1	1 unit 1 unit	101 101	9.100 10.513
	500	160	250	355	400	610	1	1	96 ... 127 200 ... 277	B B	3RT10 76-6QF35 3RT10 76-6QP35	1 1	1 unit 1 unit	101 101	11.730 9.100

For other voltages, see page 3/29.

For accessories, see page 3/112.

For spare parts, see page 3/130.

1) Alternatively the 3RT10 54-1 contactor (55 kW) can be supplied with bar connections instead of box terminals.
Without additional charge. In the 8th position of the Order No. the "1" must be replaced with "6", e.g. 3RT10 54-6...

3RT, 3TB, 3TF Contactors for Switching Motors

3RT10 contactors, 3-pole, 3 ... 250 kW

Rated control supply voltages

Contactor type	3RT10 1	3RT10 2, 3RT10 3, 3RT10 4	3RT14 4	3RT13 1, 3RT15 1	3RT13 2 to 3RT13 4, 3RT15 2 and 3RT15 3	3RT16
Rated control supply voltage U_s						

Rated control supply voltages (the 10th and 11th position of the order number must be changed)

Sizes S00 ... S3

• AC operation¹⁾

Coils for 50 Hz (exception: size S00: 50 and 60 Hz²⁾)

24 V AC	B0	B0	B0	B0	B0	B0
42 V AC	D0	D0	D0	D0	--	--
48 V AC	H0	H0	H0	H0	--	--
110 V AC	F0	F0	F0	F0	F0	F0
230 V AC	P0	P0	P0	P0	P0	P0
400 V AC	V0	V0	V0	V0	V0	V0

Coils for 50 and 60 Hz²⁾

24 V AC	B0	C2	C2	B0	C2	C2
42 V AC	D0	D2	D2	D0	D2	--
48 V AC	H0	H2	H2	H0	H2	--
110 V AC	F0	G2	G2	F0	G2	G2
220 V AC	N2	N2	N2	N2	N2	N2
230 V AC	P0	L2	L2	P0	L2	L2

For USA and Canada³⁾

50 Hz	60 Hz					
110 V AC	120 V AC	K6	K6	K6	K6	K6
220 V AC	240 V AC	P6	P6	P6	P6	P6

For Japan

50/60 Hz ⁴⁾	60 Hz ⁵⁾					
100 V AC	110 V AC	G6	G6	G6	G6	G6
200 V AC	220 V AC	N6	N6	N6	N6	N6
400 V AC	440 V AC	R6	R6	R6	R6	R6

• DC operation¹⁾

12 V DC	A4	--	--	A4	--	--
24 V DC	B4	B4	B4	B4	B4	--
42 V DC	D4	D4	D4	D4	D4	--
48 V DC	W4	W4	W4	W4	--	--
60 V DC	E4	E4	E4	--	--	--
110 V DC	F4	F4	F4	F4	F4	--
125 V DC	G4	G4	G4	G4	G4	--
220 V DC	M4	M4	M4	M4	M4	--
230 V DC	P4	P4	P4	P4	--	--

Sizes S6 ... S12

• AC/DC operation (40 ... 60 Hz, DC)

Conventional operating mechanism

$U_{s \min} \dots U_{s \max}$ ⁶⁾	Contactor type	3RT1. 5.-.A 3RT1. 6.-.A 3RT1. 7.-.A	$U_{s \min} \dots U_{s \max}$ ⁶⁾	Contactor type	3RT1. 5.-.A 3RT1. 6.-.A 3RT1. 7.-.A
23 ... 26 V AC/DC		B3	240 ... 277 V AC/DC		U3
42 ... 48 V AC/DC		D3	380 ... 420 V AC/DC		V3
110 ... 127 V AC/DC		F3	440 ... 480 V AC/DC		R3
200 ... 220 V AC/DC		M3	500 ... 550 V AC/DC		S3
220 ... 240 V AC/DC		P3	575 ... 600 V AC/DC		T3

Solid-state operating mechanism

$U_{s \min} \dots U_{s \max}$ ⁶⁾	Contactor type	3RT1. 5.-.N 3RT1. 6.-.N 3RT1. 7.-.N	3RT1. 5.-.P/Q 3RT1. 6.-.P/Q 3RT1. 7.-.P/Q
21 ... 27.3 V AC/DC		B3	--
96 ... 127 V AC/DC		F3	F3
200 ... 277 V AC/DC		P3	P3

1) For deviating coil voltages and coil operating ranges of sizes S00 and S0, the 24 V DC SITOP Power power supply with wide range input (93 to 264 V AC; 30 to 264 V DC) can be used for coil excitation (see Power Supplies -> SITOP Power Power Supplies).

2) Coil operating range
at 50 Hz: 0.8 to 1.1 x U_s
at 60 Hz: 0.85 to 1.1 x U_s

3) Coil operating range
Size S00: at 50 Hz: 0.85 to 1.1 x U_s
at 60 Hz: 0.8 to 1.1 x U_s
Sizes S0 to S3: at 50 Hz and 60 Hz: 0.8 to 1.1 x U_s

4) Coil operating range
Size S00: at 50/60 Hz: 0.85 to 1.1 x U_s
Sizes S0 to S3: at 50 Hz: 0.8 to 1.1 x U_s
at 60 Hz: 0.85 to 1.1 x U_s

5) Coil operating range
at 60 Hz: 0.8 to 1.1 x U_s

6) Operating range:
0.8 x $U_{s \min}$ to 1.1 x $U_{s \max}$

3RT, 3TB, 3TF Contactors for Switching Motors

3RT12 vacuum contactors, 3-pole, 110 ... 250 kW

Overview

- 3RT12 vacuum contactors for switching motors

Operating mechanism types

Two types of solenoid operation are available:

- Conventional operating mechanism, version 3RT12 ...-A
- Solid-state operating mechanism, version 3RT12 ...-N

UC operation

The contactors can be operated with AC (40 to 60 Hz) as well as with DC.

Withdrawable coils

For simple coil replacement, e.g. if the application is replaced, the magnetic coil can be pulled out upwards after the release mechanism has been actuated and can be replaced by any other coil of the same size.

Auxiliary contact complement

The contactors can be fitted with up to 8 laterally mounted auxiliary contacts (identical auxiliary switch blocks from S0 to S12). Of these, no more than 4 are permitted to be NC contacts.

Selection and ordering data

AC/DC operation (40 Hz to 60 Hz, DC)

Auxiliary and control conductors: screw terminals

Withdrawable coils

Integrated coil circuit (varistor)

Main conductors: bar connections



3RT12 7.

3RT12 7.

Size	Rated data						Auxiliary contacts, lateral		Rated control supply voltage U_s	DT	Order No.	Price per PU	PU (UNIT, SET, M)	PS*	PG	Weight per PU approx.
	AC-2 and AC-3, T_U : up to 60 °C		AC-1, T_U : 40 °C				NO	NC	V AC/DC							kg
	Operational current I_e up to	Ratings of induction motors at 50 Hz and				Operational current I_e up to										
	1000 V	230 V	400 V	500 V	690 V	1000 V										
	A	kW	kW	kW	kW	A										
Conventional operating mechanism																
S10	225	55	110	160	200	330	2	2	110 ... 127 220 ... 240	A	3RT12 64-6AF36 3RT12 64-6AP36		1	1 unit	101	7.355 7.225
	265	75	132	160	250	330	2	2	110 ... 127 220 ... 240	A	3RT12 65-6AF36 3RT12 65-6AP36		1	1 unit	101	7.386 7.300
	300	90	160	200	250	330	2	2	110 ... 127 220 ... 240	A	3RT12 66-6AF36 3RT12 66-6AP36		1	1 unit	101	7.331 7.318
S12	400	132	200	250	400	610	2	2	110 ... 127 220 ... 240	A	3RT12 75-6AF36 3RT12 75-6AP36		1	1 unit	101	10.500 10.397
	500	160	250	355	500	610	2	2	110 ... 127 220 ... 240	A	3RT12 76-6AF36 3RT12 76-6AP36		1	1 unit	101	10.534 10.400
Solid-state operating mechanism · for 24 V DC PLC output																
S10	225	55	110	160	200	330	2	2	96 ... 127 200 ... 277	B	3RT12 64-6NF36 3RT12 64-6NP36		1	1 unit	101	7.400 7.394
	265	75	132	160	250	330	2	2	96 ... 127 200 ... 277	B	3RT12 65-6NF36 3RT12 65-6NP36		1	1 unit	101	7.400 7.399
	300	90	160	200	250	330	2	2	96 ... 127 200 ... 277	B	3RT12 66-6NF36 3RT12 66-6NP36		1	1 unit	101	7.402 7.407
S12	400	132	200	250	400	610	2	2	96 ... 127 200 ... 277	B	3RT12 75-6NF36 3RT12 75-6NP36		1	1 unit	101	7.250 10.250
	500	160	250	355	500	610	2	2	96 ... 127 200 ... 277	B	3RT12 76-6NF36 3RT12 76-6NP36		1	1 unit	101	10.580 10.246

For other voltages, see page 3/29.

For more 3TF68/69 vacuum contactors (335 kW and 450 kW), see page 3/32.

For accessories, see page 3/114.

* You can order this quantity or a multiple thereof.

3RT, 3TB, 3TF Contactors for Switching Motors

3TF6 vacuum contactors, 3-pole, 335 ... 450 kW

Overview

IEC 60947-4-1, EN 60947-4-1 (VDE 0660 Part 102)

The 3TF68/69 contactors are climate-proof. They are finger-safe according to EN 50274. Terminal covers (see Accessories and Spare Parts, page 3/135) may have to be fitted onto the connecting bars, depending on the configuration with other devices.

3RT, 3TB, 3TF Contactors for Switching Motors

3TF6 vacuum contactors, 3-pole, 335 ... 450 kW

Selection and ordering data

Auxiliary and control conduct.: screw terminals
Main conductors: bar connections
Size 14



3TF68

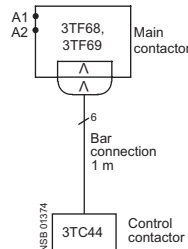

3TF6. 33-Q..

Rated data		AC - 1		Auxiliary contacts		Rated control supply voltage		DT	Order No.	Price per PU	PU (UNIT, SET, M)	PS*	PG	Weight per PU approx.	
AC-2 and AC-3 (up to 55 °C)		AC - 1		Version		U_s								kg	
Operational current I_e up to 690 V	Ratings of induction motors at 50 Hz and					Operational current I_e (at 40 °C)									
	230 V	400 V	500 V	690 V	1000 V		NO	NC							V
A	kW	kW	kW	kW	kW	A									
AC operation^{1) 2)}															
630	200	335	434	600	--	700	4	4	110 ... 132 AC, 50/60 Hz	▶	3TF68 44-0CF7	1	1 unit	101	19.364
									200 ... 240 AC, 50/60 Hz	▶	3TF68 44-0CM7	1	1 unit	101	19.820
630	200	335	434	600	600	700	4	4	110 ... 132 AC, 50/60 Hz	C	3TF68 44-8CF7	1	1 unit	101	19.670
									200 ... 240 AC, 50/60 Hz	B	3TF68 44-8CM7	1	1 unit	101	20.270
820	260	450	600	800	--	910	4	4	110 ... 132 AC, 50/60 Hz	A	3TF69 44-0CF7	1	1 unit	101	21.833
									200 ... 240, 50/60 Hz	▶	3TF69 44-0CM7	1	1 unit	101	22.105
820	260	450	600	800	800	910	4	4	110 ... 132 AC, 50/60 Hz	C	3TF69 44-8CF7	1	1 unit	101	22.307
									200 ... 240 AC, 50/60 Hz	C	3TF69 44-8CM7	1	1 unit	101	22.454
DC operation · DC economy circuit															
630	200	335	434	600	--	700	3	3	24 DC	C	3TF68 33-1DB4	1	1 unit	101	19.532
					600						3TF68 33-8DB4	1	1 unit	101	17.900
820	260	450	600	800	--	910	3	3	24 DC	C	3TF69 33-1DB4	1	1 unit	101	22.666
					800						3TF69 33-8DB4	1	1 unit	101	12.258
AC operation · Version for AC controls which are subj. to strong interference															
630	200	335	434	600	--	700	3	3	110 ... 120 AC, 50/60 Hz	C	3TF68 33-1QG7	1	1 unit	101	18.592
									220 ... 240 AC, 50/60 Hz	C	3TF68 33-1QL7	1	1 unit	101	21.100
									380 ... 420 AC, 50/60 Hz	C	3TF68 33-1QV7	1	1 unit	101	20.739
					600	700	3	3	110 ... 120 AC, 50/60 Hz	C	3TF68 33-8QG7	1	1 unit	101	21.000
									220 ... 240 AC, 50/60 Hz	C	3TF68 33-8QL7	1	1 unit	101	21.034
820	260	450	600	800	--	910	3	3	110 ... 120 AC, 50/60 Hz	C	3TF69 33-1QG7	1	1 unit	101	22.512
									220 ... 240 AC, 50/60 Hz	C	3TF69 33-1QL7	1	1 unit	101	22.400
									380 ... 420 AC, 50/60 Hz	C	3TF69 33-1QV7	1	1 unit	101	22.625
					800	910	3	3	110 ... 120 AC, 50/60 Hz	C	3TF69 33-8QG7	1	1 unit	101	21.900
									220 ... 240 AC, 50/60 Hz	C	3TF69 33-8QL7	1	1 unit	101	22.897

Reversing contactors supplied: 3TC44 17-4A..

For accessories, see page 3/134, for spare parts, see page 3/144.

1) Built-in overvoltage damping: varistor circuit.

2) For more information on EMC, see LV 1 T.

3TF68/69 vacuum contactors are supplied with integrated overvoltage damping for the main conducting paths (for description, see LV 1 T). The overvoltage damping circuit is not required if 3TF68/69 contactors are used in circuits with DC choppers, frequency converters or speed-variable drives, for example. It could be damaged by the voltage peaks and harmonics and cause phase-to-phase short-circuits. For this reason, the contactors can also be supplied without integrated voltage damping. Without additional charge. The order number must include **"-Z"** and the order code **"A02"**.

* You can order this quantity or a multiple thereof.

3RT, 3TB, 3TF Contactors for Switching Motors

3TF6 vacuum contactors, 3-pole, 335 ... 450 kW

Rated control supply voltages

Contactor	Type	3TF 3TF68...-C/D 3TF69...-C/D
-----------	------	-------------------------------------

Rated control supply voltages (the 10th and 11th position of the order number must be changed)

AC operation · Magnetic coils for 50/60 Hz

110 ... 132 V AC	F7
200 ... 240 V AC	M7
230 ... 277 V AC	P7
380 ... 460 V AC	Q7
500 ... 600 V AC	S7

DC operation

24 V DC	B4
110 V DC	F4
125 V DC	G4
220 V DC	M4
230 V DC	P4

3RT, 3TB, 3TF Contactors for Switching Motors

3TB5 contactors with DC solenoid system, 3-pole, 55 ... 200 kW

Selection and ordering data

Auxiliary and control conductors: screw terminals

Main conductors: bar connections



3TB50

Size	Rated data AC-2 and AC-3 (up to 55 °C)					AC -1	Auxiliary contacts		Rated control supply voltage U_s	DT	Order No.	Price per PU	PU (UNIT, SET, M)	PS*	PG	Weight per PU approx.
	Opera-tional cur-rent I_e up to	Ratings of induction motors at 50 Hz and				Opera-tional cur-rent I_e (at 40 °C)	Version									kg
	690 V	230 V	400 V	500 V	690 V	A	NO	NC	V DC							
	A	kW	kW	kW	kW	A										
DC operation · DC solenoid system																
6	110	37	55	75	90	170	2	2	24	A	3TB50 17-0BB4		1	1 unit	101	6.436
8	170	55	90	110	132	230	2	2	24	B	3TB52 17-0BB4		1	1 unit	101	8.468
10	250	75	132	160	200	325	2	2	24	C	3TB54 17-0BB4		1	1 unit	101	16.510
12	400	115	200	255	355	425	2	2	24	C	3TB56 17-0BB4		1	1 unit	101	19.318

For accessories, see page 3/134.

For spare parts, see page 3/142.

Contactor	Type	3TB	3TB56
		3TB50/3TB52/3TB54	3TB56
Rated control supply voltages (the 10th and 11th position of the order number must be changed)			
DC operation			
24 V DC		B4	B4
110 V DC		F4	--
220 V DC		M4	M4

3RT, 3TB, 3TF Contactors for Switching Motors

3TF2 contactors, 3-pole, 2.2 ... 4 kW

Overview

AC and DC operation

IEC 60947 (VDE 0660).

The contactors are suitable for use in any climate.

The contactors with screw terminals are finger-safe according to EN 50274.

The contactors are available in versions with screw terminals, 6.3 mm plug connectors and solder pin connectors for soldering in printed circuit boards.

Selection and ordering data

Size 00

AC-1: operational current $I_e = 16 A$ (at 55 °C)

Screw terminals

Rated data Utilization categories AC-2 and AC-3		Auxiliary contacts		DT	Order No.	Price per PU	PU (UNIT, SET, M)	PS*	PG	Weight per PU approx.
Operational current I_e	Ratings of induction motors at 50 Hz and	Ident. No.	Version							
at 400/380 V	230/220 V 400/380 V 500 V 690/660 V			NO NC						kg

Contactors with screw terminals · for screw and snap-on mounting onto 35 mm standard mounting rail



3TF20 ...-0...,
3TF28 ...-0...

AC operation

5	1.3	2.2	2.9	3.8	10 E	1	--	A	3TF28 10-0AP0	1	1 unit	101	0.194
					01 E	--	1	A	3TF28 01-0AP0	1	1 unit	101	0.193
9	2.4	4	4	4	10 E	1	--	A	3TF20 10-0AP0	1	1 unit	101	0.192
					01 E	--	1	A	3TF20 01-0AP0	1	1 unit	101	0.193

DC operation · DC solenoid system

5	1.3	2.2	2.9	3.8	10 E	1	--	A	3TF28 10-0BB4	1	1 unit	101	0.214
					01 E	--	1	A	3TF28 01-0BB4	1	1 unit	101	0.214
9	2.4	4	4	4	10 E	1	--	A	3TF20 10-0BB4	1	1 unit	101	0.214
					01 E	--	1	A	3TF20 01-0BB4	1	1 unit	101	0.214

Contactors with 6.3 mm x 0.8 mm flat connectors · for screw and snap-on mounting onto 35 mm standard mounting rail



3TF20 ...-3...

AC operation

9	2.4	4	4	--	10 E	1	--	B	3TF20 10-3AP0	1	1 unit	101	0.166
					01 E	--	1	B	3TF20 01-3AP0	1	1 unit	101	0.163

DC operation · DC solenoid system

9	2.4	4	4	--	10 E	1	--	B	3TF20 10-3BB4	1	1 unit	101	0.187
					01 E	--	1	C	3TF20 01-3BB4	1	1 unit	101	0.187

Contactors with 6.3 mm x 0.8 mm flat connectors · for screw mounting (diagonal)



3TF20 ...-7...

AC operation

9	2.4	4	4	--	10 E	1	--	C	3TF20 10-7AP0	1	1 unit	101	0.161
					01 E	--	1	B	3TF20 01-7AP0	1	1 unit	101	0.160

DC operation · DC solenoid system

9	2.4	4	4	--	10 E	1	--	B	3TF20 10-7BB4	1	1 unit	101	0.184
					01 E	--	1	B	3TF20 01-7BB4	1	1 unit	101	0.185

Contactors with solder pin connectors for printed circuit boards · for screw mounting (diagonal)



3TF20 ...-6...

AC operation

9	2.4	4	4	--	10 E	1	--	C	3TF20 10-6AP0	1	1 unit	101	0.164
					01 E	--	1	B	3TF20 01-6AP0	1	1 unit	101	0.164

DC operation · DC solenoid system

9	2.4	4	4	--	10 E	1	--	B	3TF20 10-6BB4	1	1 unit	101	0.186
					01 E	--	1	B	3TF20 01-6BB4	1	1 unit	101	0.184

For accessories, see page 3/136.

3RT, 3TB, 3TF Contactors for Switching Motors

3TF2 contactors, 3-pole, 2.2 ... 4 kW

Rated data Utilization categories AC-2 and AC-3		Auxiliary contacts		DT	Order No.	Price per PU	PU (UNIT, SET, M)	PS*	PG	Weight per PU approx.
Operational current I_e	Ratings of induction motors at 50 Hz and	Ident. No.	Version							
at 400/380 V	230/220 V 400/380 V 500 V 690/660 V									
A	kW kW kW kW		NO NC							kg

3 Contactors with permanently mounted auxiliary switch blocks with screw terminals, width 45 mm for screw and snap-on mounting onto 35 mm standard mounting rail



AC operation

5	1.3	2.2	2.9	3.8	11 E	1	1	C	3TF29 11-0AP0	1	1 unit	101	0.220
					22 E	2	2	C	3TF29 22-0AP0	1	1 unit	101	0.228
9	2.4	4	4	4	11 E	1	1	C	3TF22 11-0AP0	1	1 unit	101	0.220
					22 E	2	2	C	3TF22 22-0AP0	1	1 unit	101	0.228

DC operation · DC solenoid system

5	1.3	2.2	2.9	3.8	11 E	1	1	C	3TF29 11-0BB4	1	1 unit	101	0.241
					22 E	2	2	C	3TF29 22-0BB4	1	1 unit	101	0.251
9	2.4	4	4	4	11 E	1	1	C	3TF22 11-0BB4	1	1 unit	101	0.238
					22 E	2	2	C	3TF22 22-0BB4	1	1 unit	101	0.250

3TF22 ...-0...,
3TF29 ...-0...

For accessories, see page 3/136.

Rated control supply voltages

Contactor	Type	3TF20 3TF28
Rated control supply voltages (the 10th and 11th position of the order number must be changed)		
AC operation		
Coils for AC 50 and 60 Hz Rated control supply voltage U_s		
Coils for AC 50 Hz		
50 Hz	60 Hz	
V AC	V AC	
24	29	B0
110	132	F0
230/220	276	P0 ¹⁾
Coils for AC 50 and 60 Hz		
V AC		
230		L2
DC operation		
Rated control supply voltage U_s		
V DC		
24		B4

Contactor	Type	3TF22 3TF29
Rated control supply voltages (the 10th and 11th position of the order number must be changed)		
AC operation		
Coils for AC 50 and 60 Hz Rated control supply voltage U_s		
Coils for AC 50 Hz		
50 Hz	60 Hz	
V AC	V AC	
230/220	276	P0 ¹⁾
DC operation		
Rated control supply voltage U_s		
V DC		
24		B4

1) Operating range at 220 V:
0.85 to 1.15 x U_s ; lower operating range limit according to IEC 60947.

Please inquire about other voltages.

3RT, 3TB, 3TF Contactors for Switching Motors

Notes

3

3RA13, 3RA14 Contactor Assemblies

3RA13 Reversing Contactor Assemblies

3RA13 complete units, 3 ... 45 kW

Overview

The 3RA13 reversing contactor assemblies can be ordered as follows:

Sizes S00 to S3

- Fully wired and tested, with mechanical and electrical interlock (for voltages > 500 V, a dead interval of 50 ms on reversing must be taken into account)

Sizes S00 to S12

- As components for customer assembly.

There is also a range of accessories (auxiliary switch blocks, surge suppressors, etc.) that must be ordered separately.

For overload relays for motor protection, see "SIRIUS Overload Relays".

The 3RA13 contactor assemblies have screw connections and are suitable for screwing or snapping onto 35 mm standard mounting rails.

Complete units

The fully wired reversing contactor assemblies are suitable for use in any climate. They are finger-safe according to EN 50274.

The contactor assemblies consist of 2 contactors with the same power, with one NC contact in the basic unit. The contactors are mechanically and electrically interlocked (NC contact interlock).

For motor protection, either 3RU11 overload relays for direct mounting or individual mounting or thermistor motor protection tripping units must be ordered separately.

Components for customer assembly

Installation kits for all sizes are available for customer assembly of reversing contactor assemblies.

Contactors, overload relays, the mechanical interlock (as of size S0) and – for momentary-contact operation – auxiliary switch blocks for latching must be ordered separately.

Rated data AC-2 and AC-3 for AC 50 Hz 400 V		Size	Order No.					Fully wired and tested contactor assemblies
Rating	Operational current I_e		Contactor	Mechanical interlock ¹⁾	Mechanical interlock ²⁾	Mechanical interlock ³⁾	Installation kit	
kW	A							
3	7	S00	3RT10 15	-- ⁴⁾	--	--	3RA19 13-2A ⁵⁾	3RA13 15-8XB30-1 ..
4	9		3RT10 16					3RA13 16-8XB30-1 ..
5.5	12		3RT10 17					3RA13 17-8XB30-1 ..
5.5	12	S0	3RT10 24	3RA19 24-1A	3RA19 24-2B	--	3RA19 23-2A ⁶⁾	3RA13 24-8XB30-1 ..
7.5	17		3RT10 25					3RA13 25-8XB30-1 ..
11	25		3RT10 26					3RA13 26-8XB30-1 ..
15	32	S2	3RT10 34	3RA19 24-1A	3RA19 24-2B	--	3RA19 33-2A ⁷⁾	3RA13 34-8XB30-1 ..
18.5	40		3RT10 35					3RA13 35-8XB30-1 ..
22	50		3RT10 36					3RA13 36-8XB30-1 ..
30	65	S3	3RT10 44	3RA19 24-1A	3RA19 24-2B	--	3RA19 43-2A ⁷⁾	3RA13 44-8XB30-1 ..
37	80		3RT10 45					3RA13 45-8XB30-1 ..
45	95		3RT10 46					3RA13 46-8XB30-1 ..
55	115	S6	3RT10 54	--	--	3RA19 54-2A	3RA19 53-2A ⁸⁾	--
75	150		3RT10 55					
90	185		3RT10 56					
110	225	S10	3RT10 64	--	--	3RA19 54-2A	3RA19 63-2A ⁸⁾	--
132	265		3RT10 65					
160	300		3RT10 66					
200	400	S12	3RT10 75	--	--	3RA19 54-2A	3RA19 73-2A ⁸⁾	--
250	500		3RT10 76	--	--			

1) Can be mounted onto the front.

2) Laterally mountable with one auxiliary contact.

3) Laterally mountable without auxiliary contact.

4) Interlock can only be ordered with installation kit.

5) Installation kit contains: mechanical interlock; connecting clips for 2 contactors; wiring connectors on the top and bottom.

6) Installation kit contains: wiring connectors on the top and bottom.

7) Installation kit contains: 2 connecting clips for contactors; wiring connectors on the top and bottom.

8) Installation kit contains: wiring module on the top and bottom.

3RA13, 3RA14 Contactor Assemblies

3RA13 Reversing Contactor Assemblies

3RA13 complete units, 3 ... 45 kW

Selection and ordering data

Size S00 · up to 5.5 kW

Rated data AC-2 and AC-3		Rated control supply voltage $U_s^{(1)}$		DT		Fully wired and tested contactor assemblies ²⁾		PU (UNIT, SET, M)	PS*	PG	Weight per PU approx.	
Operational current I_e up to	Ratings of induction motors at 50 Hz and					Order No.	Price per PU					
400 V	230 V	400 V	500 V	690 V	V							
A	kW	kW	kW	kW	V							
AC operation, 50/60 Hz												
	7	2.2	3	3.5	4	24 AC	A	3RA13 15-8XB30-1AB0	1	1 unit	101	0.429
						110 AC	A	3RA13 15-8XB30-1AF0	1	1 unit	101	0.430
						230 AC	▶	3RA13 15-8XB30-1AP0	1	1 unit	101	0.427
	9	3	4	4.5	5.5	24 AC	A	3RA13 16-8XB30-1AB0	1	1 unit	101	0.429
						110 AC	A	3RA13 16-8XB30-1AF0	1	1 unit	101	0.428
						230 AC	▶	3RA13 16-8XB30-1AP0	1	1 unit	101	0.425
	12	3	5.5	5.5	5.5	24 AC	A	3RA13 17-8XB30-1AB0	1	1 unit	101	0.430
						110 AC	A	3RA13 17-8XB30-1AF0	1	1 unit	101	0.425
						230 AC	▶	3RA13 17-8XB30-1AP0	1	1 unit	101	0.430
DC operation												
	7	2.2	3	3.5	4	24 DC	▶	3RA13 15-8XB30-1BB4	1	1 unit	101	0.548
	9	3	4	4.5	5.5	24 DC	▶	3RA13 16-8XB30-1BB4	1	1 unit	101	0.547

1) Coil operating range at 50 Hz: 0.8 ... 1.1 x U_s ; at 60 Hz: 0.85 ... 1.1 x U_s .

2) The contactors integrated in the contactor assemblies have no unassigned auxiliary contacts.

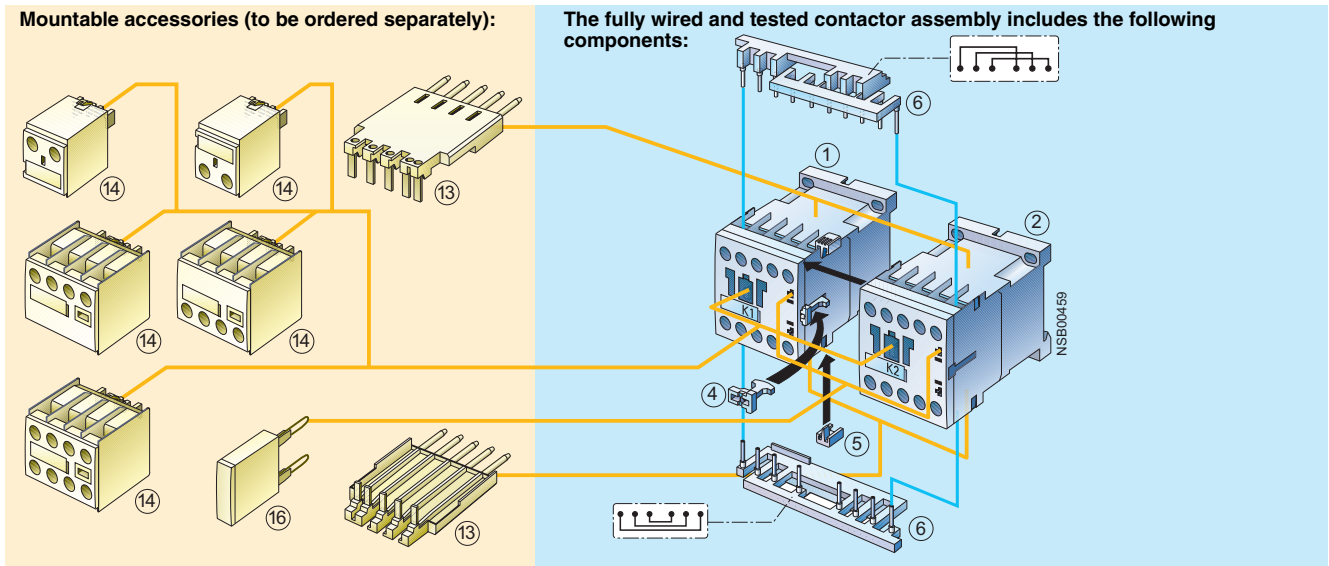

Accessories	Order No.	Page	Individual parts	Order No.		Page
				K1	K2	
13 Solder pin adapters	3RT19 16-4KA1	3/122	1 2	3RT10 15	3RT10 15	3/12
14 Auxiliary switch block, front (auxiliary switch block according to EN 50005 must be used)	3RH19 11-1....	3/110	1 2	3RT10 16	3RT10 16	3/12
			1 2	3RT10 17	3RT10 17	3/12
16 Surge suppressors	3RT19 16-1....	3/119, 3/120	4 5 6	3RA19 13-2A		3/44

The installation kit contains:

- 4 Mechanical interlock
- 5 2 connecting clips for 2 contactors
- 6 Wiring connectors on the top and bottom for connecting the main conducting paths, electrical interlock included¹⁾, interruptible (NC contact interlock)

1) 3RT10 1 contactors with one NC contact in the basic unit are required for the electrical interlock.

3RA13, 3RA14 Contactor Assemblies

3RA13 Reversing Contactor Assemblies

3RA13 complete units, 3 ... 45 kW

Size S0 · up to 11 kW



Rated data AC-2 and AC-3		Rated control supply voltage U_s ¹⁾	DT	Fully wired and tested contactor assemblies		PU (UNIT, SET, M)	PS*	PG	Weight per PU approx.	
Operational current I_e up to	Ratings of induction motors at 50 Hz and				Order No.	Price per PU			kg	
400 V	230 V	400 V	500 V	690 V						
A	kW	kW	kW	kW	V					
AC operation, 50/60 Hz										
12	3	5.5	7.5	7.5	24 AC	A	3RA13 24-8XB30-1AC2	1 1 unit	101	0.766
					110 AC	A	3RA13 24-8XB30-1AG2	1 1 unit	101	0.763
					230 AC	▶	3RA13 24-8XB30-1AL2	1 1 unit	101	0.777
17	4	7.5	10	11	24 AC	A	3RA13 25-8XB30-1AC2	1 1 unit	101	0.760
					110 AC	A	3RA13 25-8XB30-1AG2	1 1 unit	101	0.763
					230 AC	▶	3RA13 25-8XB30-1AL2	1 1 unit	101	0.773
25	5.5	11	11	11	24 AC	A	3RA13 26-8XB30-1AC2	1 1 unit	101	0.755
					110 AC	A	3RA13 26-8XB30-1AG2	1 1 unit	101	0.760
					230 AC	A	3RA13 26-8XB30-1AL2	1 1 unit	101	0.774
DC operation										
12	3	5.5	7.5	7.5	24 DC	▶	3RA13 24-8XB30-1BB4	1 1 unit	101	1.224
17	4	7.5	10	11	24 DC	A	3RA13 25-8XB30-1BB4	1 1 unit	101	1.222
25	5.5	11	11	11	24 DC	A	3RA13 26-8XB30-1BB4	1 1 unit	101	1.229

1) Coil operating range at 50 Hz: 0.8 ... 1.1 x U_s ; at 60 Hz: 0.85 ... 1.1 x U_s .

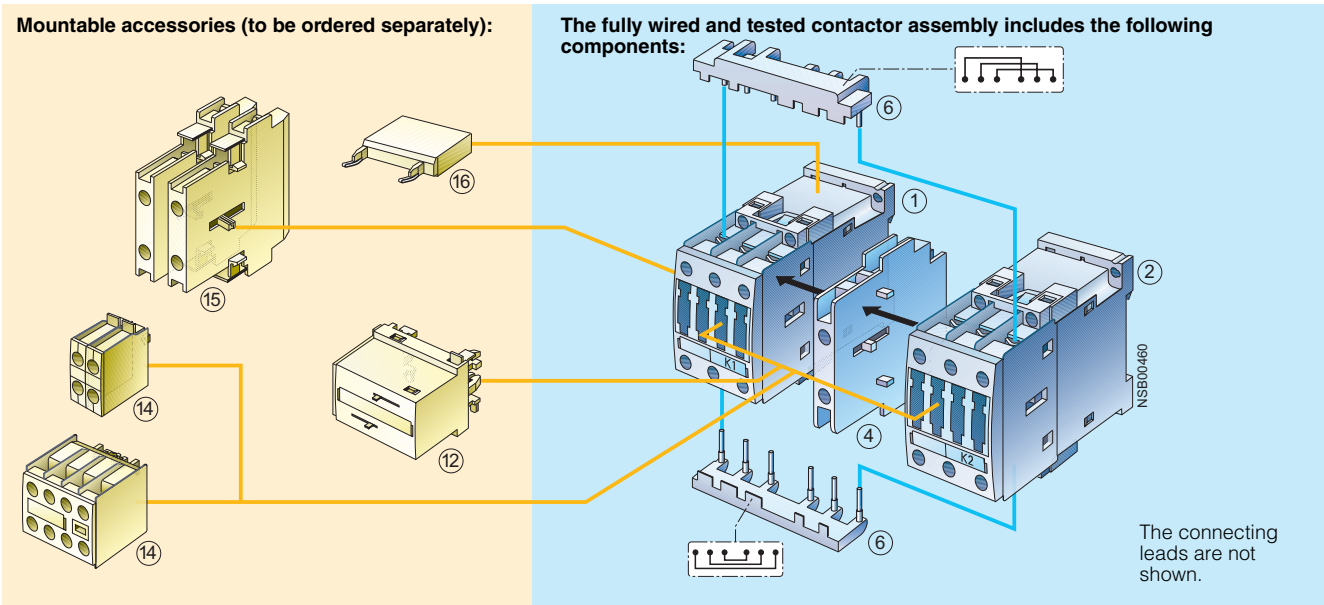

Accessories	Order No.	Page	Individual parts	Order No. K1	Order No. K2	Page
12 Mechanical interlock, front	3RA19 24-1A	3/43	1 2 Contactors, 5.5 kW	3RT10 24	3RT10 24	3/14
14 Auxiliary switch block, front	3RH19 21-1CA..	3/112	1 2 Contactors, 7.5 kW	3RT10 25	3RT10 25	3/14
15 Auxiliary switch block, lateral	3RH19 21-1EA..	3/114	1 2 Contactors, 11 kW	3RT10 26	3RT10 26	3/14
16 Surge suppressors	3RT19 26-1....	3/119	4 Mechanical interlock, lateral	3RA19 24-2B		3/43
			6 Installation kit	3RA19 23-2A		3/44

The installation kit contains wiring connectors on the top and bottom (they also form the mechanical connection between the contactors).

* You can order this quantity or a multiple thereof.

3RA13, 3RA14 Contactor Assemblies 3RA13 Reversing Contactor Assemblies

3RA13 complete units, 3 ... 45 kW

Size S2 · up to 22 kW



Rated data AC-2 and AC-3		Rated control supply voltage U_s ¹⁾		DT		Fully wired and tested contactor assemblies		PU (UNIT, SET, M)	PS*	PG	Weight per PU approx.
Operational current I_e up to	Ratings of induction motors at 50 Hz and				Order No.	Price per PU				kg	
	500 V	230 V	400 V	500 V							690 V
A	kW	kW	kW	kW	V						
AC operation, 50/60 Hz											
32	7.5	15	18.5	18.5	24 AC	A	3RA13 34-8XB30-1AC2	1	1 unit	101	2.255
					110 AC	A	3RA13 34-8XB30-1AG2	1	1 unit	101	2.265
					230 AC	A	3RA13 34-8XB30-1AL2	1	1 unit	101	2.220
40	11	18.5	22	22	24 AC	A	3RA13 35-8XB30-1AC2	1	1 unit	101	2.315
					110 AC	A	3RA13 35-8XB30-1AG2	1	1 unit	101	2.320
					230 AC	A	3RA13 35-8XB30-1AL2	1	1 unit	101	2.300
50	15	22	30	22	24 AC	B	3RA13 36-8XB30-1AC2	1	1 unit	101	2.340
					110 AC	B	3RA13 36-8XB30-1AG2	1	1 unit	101	2.315
					230 AC	A	3RA13 36-8XB30-1AL2	1	1 unit	101	2.290
DC operation											
32	7.5	15	18.5	18.5	24 DC	A	3RA13 34-8XB30-1BB4	1	1 unit	101	3.440
40	11	18.5	22	22	24 DC	A	3RA13 35-8XB30-1BB4	1	1 unit	101	3.445
50	15	22	30	22	24 DC	A	3RA13 36-8XB30-1BB4	1	1 unit	101	3.454

1) Coil operating range at 50 Hz: 0.8 ... 1.1 x U_s ; at 60 Hz: 0.85 ... 1.1 x U_s .

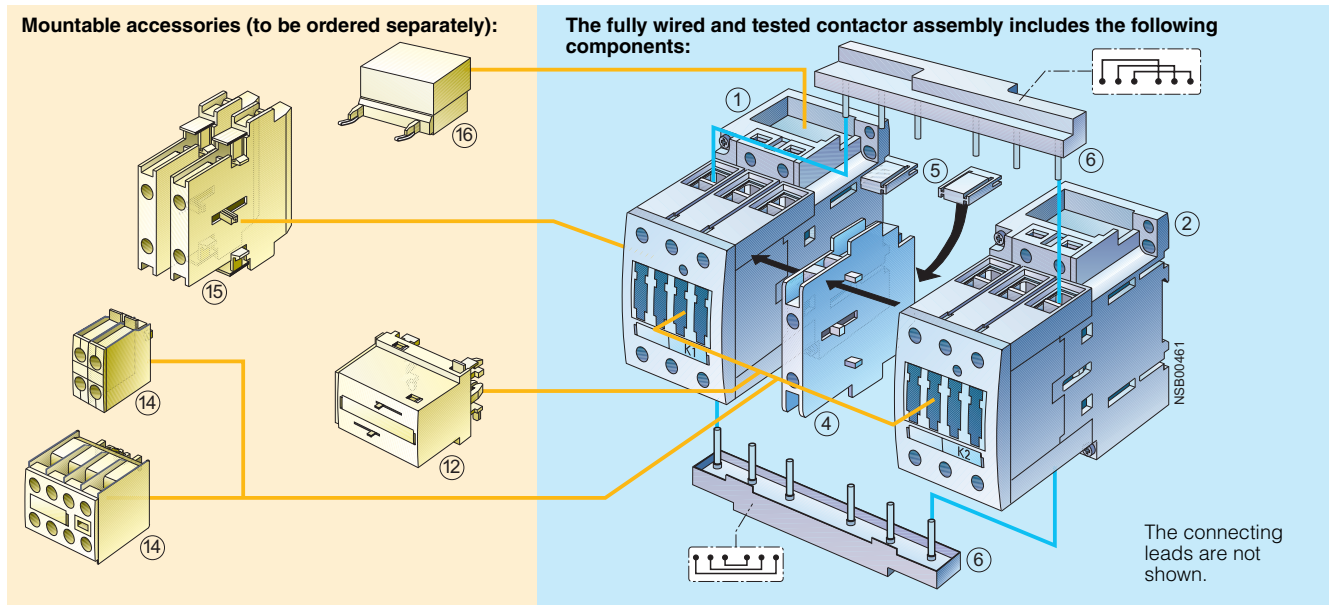

Accessories	Order No.	Page	Individual parts	Order No.	Page
12	3RA19 24-1A	3/43	1 2 Contactors, 15 kW	3RT10 34	3/16
14	3RH19 21-1CA..	3/112	1 2 Contactors, 18.5 kW	3RT10 35	3/16
15	3RH19 21-1EA..	3/114	1 2 Contactors, 22 kW	3RT10 36	3/16
16	3RT19 26-1.... 3RT19 36-1....	3/119	4 Mechanical interlock, lateral	3RA19 24-2B	3/43
			5 6 Installation kit	3RA19 33-2A	3/44
			The installation kit contains:		
			5 2 connecting clips for 2 contactors with a clearance of 10 mm		
			6 Wiring connectors on the top and bottom for connecting the main conducting paths		

* You can order this quantity or a multiple thereof.

3RA13, 3RA14 Contactor Assemblies

3RA13 Reversing Contactor Assemblies

3RA13 complete units, 3 ... 45 kW

Size S3 · up to 45 kW



Rated data AC-2 and AC-3		Rated control supply voltage U_s ¹⁾	DT	Fully wired and tested contactor assemblies		PU (UNIT, SET, M)	PS*	PG	Weight per PU approx.	
Operational current I_e up to	Ratings of induction motors at 50 Hz and				Order No.	Price per PU			kg	
500 V	230 V	400 V	500 V	690 V						
A	kW	kW	kW	kW	V					
AC operation at 50/60 Hz										
65	18.5	30	37	45	24 AC	B	3RA13 44-8XB30-1AC2	1 1 unit	101	4.242
					110 AC	B	3RA13 44-8XB30-1AG2	1 1 unit	101	4.250
					230 AC	B	3RA13 44-8XB30-1AL2	1 1 unit	101	4.221
80	22	37	45	55	24 AC	B	3RA13 45-8XB30-1AC2	1 1 unit	101	4.432
					110 AC	B	3RA13 45-8XB30-1AG2	1 1 unit	101	4.500
					230 AC	B	3RA13 45-8XB30-1AL2	1 1 unit	101	4.500
95	22	45	55	55	24 AC	B	3RA13 46-8XB30-1AC2	1 1 unit	101	4.464
					110 AC	B	3RA13 46-8XB30-1AG2	1 1 unit	101	4.500
					230 AC	B	3RA13 46-8XB30-1AL2	1 1 unit	101	4.470
DC operation										
65	18.5	30	37	45	24 DC	B	3RA13 44-8XB30-1BB4	1 1 unit	101	6.380
80	22	37	45	55	24 DC	B	3RA13 45-8XB30-1BB4	1 1 unit	101	6.430
95	22	45	55	55	24 DC	B	3RA13 46-8XB30-1BB4	1 1 unit	101	6.471

1) Coil operating range at 50 Hz: 0.8 ... 1.1 x U_s ; at 60 Hz: 0.85 ... 1.1 x U_s .

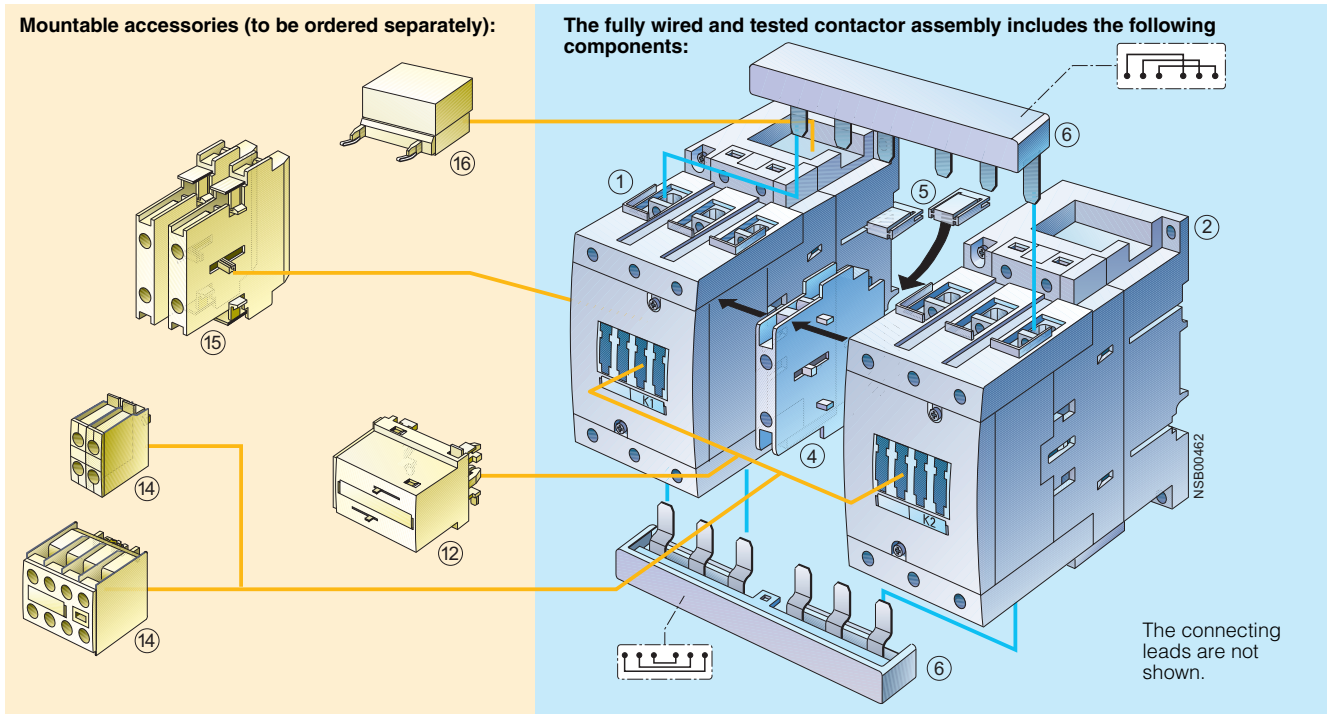

Accessories	Order No.	Page	Individual parts	Order No.		Page
				K1	K2	
12 Mechanical interlock, front	3RA19 24-1A	3/43	1 2 Contactors, 30 kW	3RT10 44	3RT10 44	3/18
14 Auxiliary switch block, front	3RH19 21-1CA..	3/112	1 2 Contactors, 37 kW	3RT10 45	3RT10 45	3/18
15 Auxiliary switch block, lateral	3RH19 21-1EA..	3/114	1 2 Contactors, 45 kW	3RT10 46	3RT10 46	3/18
16 Surge suppressors	3RT19 26-1.... 3RT19 36-1....	3/119	4 Mechanical interlock, lateral	3RA19 24-2B		3/43
			5 6 Installation kit	3RA19 43-2A		3/44





* You can order this quantity or a multiple thereof.

3RA13, 3RA14 Contactor Assemblies

3RA13 Reversing Contactor Assemblies

Components for customer assembly

Selection and ordering data

For contactors	Size	Version	DT	Order No.	Price per PU	PU (UNIT, SET, M)	PS*	PG	Weight per PU approx. kg							
Mechanical interlocks																
 <p>3RA19 24-1A mounted onto 2 contactors</p>	3RT10 2	S0	For lateral mounting¹⁾ Each with one auxiliary contact (1 NC contact) per contactor (can only be used to connect contactors which are not more than 1 size larger or smaller. The mounting depth of the smaller contactor has to be adapted.)	▶	3RA19 24-2B	1	1 unit	101	0.060							
	3RT10 3	S2														
	3RT10 4	S3														
	3RT13 2															
	3RT13 3															
3RT13 4																
 <p>3RA19 54-2A</p>	3RT10 2	S0	For mounting to the front²⁾ To contactors with sizes S0 to S3 (for contactors of the same size) Note: Size S0: Wiring connectors must be mounted first Sizes S2 and S3: Use 3RA19 32-2C mechanical connectors	▶	3RA19 24-1A	1	1 unit	101	0.052							
	3RT10 3	S2														
	3RT10 4	S3														
	3RT13 2	S0														
 <p>3RA19 54-2C</p>	3RT1. 5 up to 3RT1. 7	S6 S10 S12	For lateral mounting Without auxiliary contacts; size S6, S10 and S12 contactors can be interlocked with each other as required; no adaptation of mounting depth is necessary. Contactor clearance 10 mm.	▶	3RA19 54-2A	1	1 unit	101	0.045							
	3RT10 4.-A with 3RT10 5	S3 with S6								Adapter, laterally mountable , for mechanical interlocking of contactor S3 (only for AC operation) with contactor S6 using 3RA1954-2A locking device (must be ordered separately) incl. connecting clips	A	3RA19 54-2C	1	1 unit	101	0.050
Coil repeat terminals																
 <p>3RA19 23-3B</p>	3RT10 3	S2, S3	For the coil connectors A1 and A2 for reversing starters (contactor sizes S2 and S3). 2 x A1 and 1 x A2 required per assembly. (1 set contains 10 x A1 and 5 x A2)	B	3RA19 23-3B	1	1 set	101	0.082							
	3RT10 4															
Base plates																
	3RT10 5	S6	For customer assembly of reversing contactor assemblies	B	3RA19 52-2A	1	1 unit	101	1.249							
	3RT1. 6	S10		B	3RA19 62-2A	1	1 unit	101	2.091							
	3RT1. 7	S12		B	3RA19 72-2A	1	1 unit	101	2.322							

1) Can also be used for 4-pole contactors with sizes S2 and S3.



2) Can also be used for size S0 4-pole contactors.

3RA13, 3RA14 Contactor Assemblies

3RA13 Reversing Contactor Assemblies

Components for customer assembly

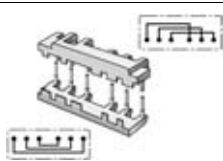
3

For contactors	Size	Version	DT	Order No.	Price per PU	PU (UNIT, SET, M)	PS*	PG	Weight per PU approx. kg
Installation kits for making 3-pole contactor assemblies									
 <p>3RA19 13-2A</p>	3RT10 1	S00	The installation kit contains: ▶ mechanical interlock 2 connecting clips for 2 contactors wiring connectors on the top and bottom						
				3RA19 13-2A		1	1 set	101	0.041
 <p>3RA19 23-2A</p>	3RT10 2	S0	The installation kit contains: ▶ wiring connectors on the top and bottom						
				3RA19 23-2A		1	1 set	101	0.052
 <p>3RA19 33-2A</p>	3RT10 3	S2	The installation kit contains: ▶ 2 connecting clips for 2 contactors wiring connectors on the top and bottom						
				3RA19 33-2A		1	1 set	101	0.122
 <p>3RA19 43-2A</p>	3RT10 4	S3	The installation kit contains: ▶ 2 connecting clips for 2 contactors wiring connectors on the top and bottom						
				3RA19 43-2A		1	1 set	101	0.294
	3RT10 5	S6	The installation kit contains:	A	3RA19 53-2A	1	1 set	101	1.294
	3RT1. 6	S10	wiring connectors on the	A	3RA19 63-2A	1	1 set	101	2.419
	3RT1. 7	S12	top and bottom	A	3RA19 73-2A	1	1 set	101	3.040

3RA13, 3RA14 Contactor Assemblies





3RA13 Reversing Contactor Assemblies

Components for customer assembly

For contactors	Size	Contact-clearance	Version	DT	Order No.	Price per PU	PU (UNIT, SET, M)	PS*	PG	Weight per PU approx.	
Type		mm								kg	
Wiring connectors	3RT10 1	S00-S00	0	Top (in-phase)	▶	3RA19 13-3D		1	5 unit	101	0.011
				Bottom (phase reversal)	▶			3RA19 13-3E		1	5 unit
	3RT10 2	S0-S0 and S0-S0	0 and 10	Top (in-phase)	▶	3RA19 23-3D		1	5 unit	101	0.021
				Bottom (phase reversal)	▶			3RA19 23-3E		1	5 unit
	3RT10 3	S2-S2	10	Top (in-phase)	▶	3RA19 33-3D		1	1 unit	101	0.066
				Bottom (phase reversal)	▶			3RA19 33-3E		1	1 unit
3RT10 4	S3-S3	10	Top (in-phase)	▶	3RA19 43-3D		1	1 unit	101	0.157	
			Bottom (phase reversal)	▶			3RA19 43-3E		1	1 unit	101
3RT10 5	S6-S6	10	Top (in-phase)	A	3RA19 53-3D		1	1 set	101	0.615	
3RT10 6	S10-S10	10	Top (phase reversal)	B	3RA19 63-3D		1	1 set	101	1.235	

For contactors	Size	Contact-clearance	Interlocking	Version	DT	Order No.	Price per PU	PU (UNIT, SET, M)	PS*	PG	Weight per PU approx.
Type		mm									kg

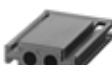
Mechanical connectors

						1 pack = 10 sets for 10 assemblies										
	3RA19 12-2H	3RT1. 1 ¹⁾	S00-S00	0	Laterally mountable	For 3 and 4-pole contactors	▶	3RA19 12-2H		1	10 sets	101	0.001			
	3RA19 22-2C	3RT1. 2	S0-S0	0 10 ²⁾	Mountable on front	For 3 and 4-pole contactors	▶	3RA19 22-2C		1	10 sets	101	0.025			
							▶			3RT19 22-2D		1	10 sets	101	0.110	
	3RA19 32-2C	3RT1. 3 3RT1. 4	S2-S2 S3-S3	0	Mountable on front	For 3-pole contactors	▶	3RA19 32-2C		1	10 sets	101	0.001			
	3RA19 32-2D	3RT1. 3 3RT1. 4 3RT1. 5	S2-S2 S3-S3 S6-S6	10	Laterally mountable	For 3-pole contactors	▶	3RA19 32-2D		1	10 sets	101	0.003			
	3RA19 32-2G	3RT1. 3	S2-S2	10	Laterally mountable	For 4-pole contactors	▶	3RA19 32-2G		1	10 sets	101	0.007			
	3RA19 42-2G	3RT1. 4	S3-S3	10	Laterally mountable	For 4-pole contactors	▶	3RA19 42-2G		1	10 sets	101	0.008			

1) This pack contains 10 additional interlocks.

2) The connector function can be fulfilled with the wiring connectors for size S0, a contactor clearance of 10 mm and a lateral interlock.

3RA13, 3RA14 Contactor Assemblies

3RA14 Contactor Assemblies for Wye-Delta Starting

3RA14 complete units, 3 ... 75 kW

Overview

The 3RA14 contactor assemblies for wye-delta starting can be ordered as follows:

Sizes S00 to S3:

- Fully wired and tested, with electrical interlock, dead interval of up to 10 s on reversing (size S00 with electrical and mechanical interlocks)

Sizes S00 to S12:

- As components for customer assembly.

A dead interval of 50 ms on reversing is already integrated in the timing relay function.

There is also a range of accessories (auxiliary switch blocks, surge suppressors, etc.) that must be ordered separately.

For overload relays for motor protection, see "Protection Equipment: Overload Relays -> 3RB2 Solid-State Overload Relays".

The 3RA14 contactor assemblies have screw terminals and are suitable for screwing or snapping onto 35 mm standard mounting rails.

Fully wired and tested 3RA14 contactor assemblies have one unassigned NO contact which is mounted onto the front of the K3 delta contactor.

A solid-state time-delay auxiliary switch block is snapped onto the front of the complete contactor assemblies, size S00 up to 7.5 kW, while a timing relay is mounted onto the side of sizes S0 to S3, 11 kW to 75 kW.

Rated data at AC 50 Hz 400 V			Size	Line/delta contactor	Wye contactor	Order No. complete	Accessories for customer assembly	Installation kit A, for double infeed
Rating kW	Operational current I_e A	motor current A					Timing relay	
5.5	12	1.9 ... 2.8	S00-S00-S00	3RT10 15	3RT10 15	3RA14 15-8XB31-1...	3RT19 16-2G.51	--
		2.4 ... 3.4						
		3.1 ... 4.3						
		3.8 ... 5.5						
		4.8 ... 6.9						
7.5	17	6 ... 8.6	S0-S0-S0	3RT10 24	3RT10 24	3RA14 23-8XC21-1...	3RP15 74-1N.30	--
		7.8 ... 10.9						
		9.5 ... 13.8						
		12.1 ... 17						
11	25	3.1 ... 4.3	S0-S0-S0	3RT10 24	3RT10 24	3RA14 23-8XC21-1...	3RP15 74-1N.30	--
		3.8 ... 5.5						
		4.8 ... 6.9						
		6 ... 8.6						
		7.8 ... 10.9						
15	32	9.5 ... 13.8	S2-S2-S0	3RT10 34	3RT10 26	3RA14 34-8XC21-1...	3RP15 74-1N.30	3RA19 33-2C ³⁾
		12.1 ... 17.2						
		15.5 ... 21.5						
		19 ... 25						
18.5	40	24.1 ... 34	S2-S2-S2	3RT10 35	3RT10 34	3RA14 35-8XC21-1...	3RA19 33-2B ³⁾	--
		29.3 ... 37.9						
22	50	34.5 ... 40	S2-S2-S2	3RT10 36	3RT10 34	3RA14 36-8XC21-1...	3RA19 33-2B ³⁾	--
		9.5 ... 13.8						
37	80	12.1 ... 17.2	S3-S3-S2	3RT10 44	3RT10 35	3RA14 44-8XC21-1...	3RP15 74-1N.30	3RA19 43-2C ³⁾
		15.5 ... 21.5						
		19 ... 27.6						
		24.1 ... 34						
		31 ... 43						
45	86	37.9 ... 55.2	S3-S3-S2	3RT10 44	3RT10 35	3RA14 44-8XC21-1...	3RP15 74-1N.30	3RA19 43-2C ³⁾
		48.3 ... 65						
55	115	62.1 ... 77.8	S6-S6-S3	3RT10 54	3RT10 44	--	3RP15 74-1N.30	--
		69 ... 86						
		31 ... 43.1						
		37.9 ... 55.2						
		48.3 ... 69						
75	150	62.1 ... 77.8	S10-S10-S6	3RT10 64	3RT10 54	--	3RP15 74-1N.30	--
		77.6 ... 108.6						
90	160	98.3 ... 129.3	S10-S10-S6	3RT10 65	3RT10 55	--	3RP15 74-1N.30	--
		120.7 ... 150						
110	195	86 ... 160	S12-S12-S10	3RT10 75	3RT10 64	--	3RP15 74-1N.30	--
		86 ... 195						
132	230	86 ... 230	S12-S12-S10	3RT10 76	3RT10 66	--	3RP15 74-1N.30	--
		86 ... 280						
160	280	86 ... 280	S12-S12-S10	3RT10 76	3RT10 66	--	3RP15 74-1N.30	--
		86 ... 280						
200	350	95 ... 350	S12-S12-S10	3RT10 76	3RT10 66	--	3RP15 74-1N.30	--
		95 ... 430						
250	430	95 ... 430	S12-S12-S10	3RT10 76	3RT10 66	--	3RP15 74-1N.30	--
		95 ... 430						
315	540	277 ... 540	S12-S12-S10	3RT10 76	3RT10 66	--	3RP15 74-1N.30	--
		277 ... 610						
355	610	277 ... 610	S12-S12-S10	3RT10 76	3RT10 66	--	3RP15 74-1N.30	--
		277 ... 690						
400	690	277 ... 690	S12-S12-S10	3RT10 76	3RT10 66	--	3RP15 74-1N.30	--
		277 ... 850						
500	850	277 ... 850	S12-S12-S10	3RT10 76	3RT10 66	--	3RP15 74-1N.30	--
		277 ... 850						

1) Installation kit contains mechanical interlock, 3 connecting clips; wiring connectors on the top (connection between mains and delta contactor) and on the bottom (connection between delta and wye contactor); neutral point.

2) The installation kit contains 5 connecting clips; wiring connectors on the top (connection between mains and delta contactor) and on the bottom (connection between delta and wye contactor); star jumper.

3) Installation kit contains wiring connector on the bottom (connection between delta contactor and wye contactor) and star jumper.

4) Wiring connector on top from reversing contactor assembly (note conductor cross-sections).

5) Only use wiring connector on top of reversing contactor assembly (note conductor cross-sections); star jumpers must be ordered separately.

3RA13, 3RA14 Contactor Assemblies

3RA14 Contactor Assemblies for Wye-Delta Starting

3RA14 complete units, 3 ... 75 kW

Components for customer assembly

Installation kits with wiring connectors and, if necessary, mechanical connectors are available for contactor assemblies for wye-delta starting. Contactors, overload relays, wye-delta timing relays, auxiliary switches for electrical interlock – if required also supply terminals, mechanical interlocks (exception: in the case of the kit for size S00 contactor assemblies the mechanical interlock between the delta contactor and the wye contactor is included in the kit) and base plates – must be ordered separately.

The wiring installation kits for sizes S00 and S0 contain the top and bottom main conducting path connections between the line and delta contactors (top) and between the delta and wye contactors (bottom).

In the case of sizes S2 to S12 only the bottom main conducting path connection between the delta and wye contactors is included in the wiring connector, owing to the larger conductor cross-section at the infeed.

Motor protection

Overload relays or thermistor motor protection trip units can be used for overload protection.

The overload relay can be either mounted onto the line contactor or separately fitted. It must be set to 0.58 times the rated motor current.

Note:

The selection of contactor types refers to fused configurations (see LV 1 T).

Installation kit B, for single infeed	Star jumper	Base plates	Overload relays, thermal (trip class CLASS 10)		Overload relays, solid-state (trip class CLASS 10)				
			Setting range	Order No.	Setting range	Order No.			
3RA19 13-2B ¹⁾	3RT19 16-4BA31	--	A		A				
			1.1 ... 1.6	3RU11 16-1AB0	0.32 ... 1.25	3RB20 16-1NB0			
			1.4 ... 2	3RU11 16-1BB0	1 ... 4	3RB20 16-1PB0			
			1.8 ... 2.5	3RU11 16-1CB0					
			2.2 ... 3.2	3RU11 16-1DB0					
			2.8 ... 4	3RU11 16-1EB0					
			3.5 ... 5	3RU11 16-1FB0	3 ... 12	3RB20 16-1SB0			
			4.5 ... 6.3	3RU11 16-1GB0					
			5.5 ... 8	3RU11 16-1HB0					
			7 ... 10	3RU11 16-1JB0					
3RA19 23-2B ²⁾	3RT19 26-4BA31	--	A		A				
			1.8 ... 2.5	3RU11 26-1CB0	1 ... 4	3RB20 16-1PB0 ⁶⁾			
			2.2 ... 3.2	3RU11 26-1DB0					
			2.8 ... 4	3RU11 26-1EB0					
			3.5 ... 5	3RU11 26-1FB0					
			4.5 ... 6.3	3RU11 26-1GB0	3 ... 12	3RB20 26-1SB0			
			5.5 ... 8	3RU11 26-1HB0					
			7 ... 10	3RU11 26-1JB0					
			9 ... 12.5	3RU11 26-1KB0	6 ... 25	3RB20 26-1QB0			
			11 ... 16	3RU11 26-4AB0					
3RA19 33-3D ⁴⁾	3RT19 26-4BA31	3RA19 32-2E	A		A				
			5.5 ... 8	3RU11 36-1HB0	3 ... 12	3RB20 26-1SB0 ⁷⁾			
			7 ... 10	3RU11 36-1JB0	6 ... 25	3RB20 36-1QB0			
			9 ... 12.5	3RU11 36-1KB0					
			11 ... 16	3RU11 36-4AB0					
	3RT19 36-4BA31	3RA19 32-2F	14 ... 20	3RU11 36-4BB0					
			18 ... 25	3RU11 36-4DB0					
			22 ... 32	3RU11 36-4EB0	12.5 ... 50	3RB20 36-1UB0			
			28 ... 40	3RU11 36-4FB0					
			36 ... 45	3RU11 36-4GB0					
3RA19 43-3D ⁴⁾	3RT19 36-4BA31	3RA19 42-2E	A		A				
			18 ... 25	3RU11 46-4DB0	12.5 ... 50	3RB20 46-1UB0			
			22 ... 32	3RU11 46-4EB0					
			28 ... 40	3RU11 46-4FB0					
			36 ... 45	3RU11 46-4HB0					
			45 ... 63	3RU11 46-4JB0	25 ... 100	3RB20 46-1EB0			
			57 ... 75	3RU11 46-4KB0					
			70 ... 90	3RU11 46-4LB0					
			3RA19 53-3D ⁴⁾	3RT19 46-4BA31	3RA19 52-2E	A		A	
						--	--	50 ... 200	3RB20 56-1FC2
3RA19 63-3D ⁴⁾	3RT19 56-4BA31	3RA19 62-2E	--	--	55 ... 250	3RB20 66-1GC2			
3RA19 73-2A ⁵⁾	3RT19 66-4BA31	3RA19 72-2E	--	--	160 ... 630	3RB20 66-1MC2			

6) Only stand-alone installations possible in combination with the 3RB29 13-0AA1 terminal bracket for stand-alone installation.

7) Only stand-alone installation possible in combination with the 3RB29 23-0AA1 terminal bracket for stand-alone installation.

3RA13, 3RA14 Contactor Assemblies

3RA14 Contactor Assemblies for Wye-Delta Starting

3RA14 complete units, 3 ... 75 kW

Selection and ordering data

Size S00-S00-S00 · up to 7.5 kW



Rated data AC-3		Rated control supply voltage U_s ¹⁾		DT	Fully wired and tested contactor assemblies		PU (UNIT, SET, M)	PS*	PG	Weight per PU approx.	
Operational current I_e at 400 V	Ratings of induction motors at 50 Hz and					Order No.	Price per PU			kg	
A	230 V	400 V	500 V	690 V							
	kW	kW	kW	kW	V						
AC operation, 50/60 Hz											
12	3.3	5.5	7.2	9.2	24 AC	C	3RA14 15-8XB31-1AB0	1	1 unit	101	0.940
					110 AC	C	3RA14 15-8XB31-1AF0	1	1 unit	101	0.934
					230 ... 230 AC	▶	3RA14 15-8XB31-1AP0	1	1 unit	101	0.948
17	4.7	7.5	10.3	9.2	24 AC	B	3RA14 16-8XB31-1AB0	1	1 unit	101	0.995
					110 AC	B	3RA14 16-8XB31-1AF0	1	1 unit	101	0.935
					230 AC	▶	3RA14 16-8XB31-1AP0	1	1 unit	101	0.928
DC operation											
12	3.3	5.5	7.2	9.2	24 DC	B	3RA14 15-8XB31-1BB4	1	1 unit	101	1.120
17	4.7	7.5	10.3	9.2	24 DC	▶	3RA14 16-8XB31-1BB4	1	1 unit	101	1.117

1) Coil operating range at 50 Hz: 0.8 ... 1.1 x U_s ; at 60 Hz: 0.85 ... 1.1 x U_s

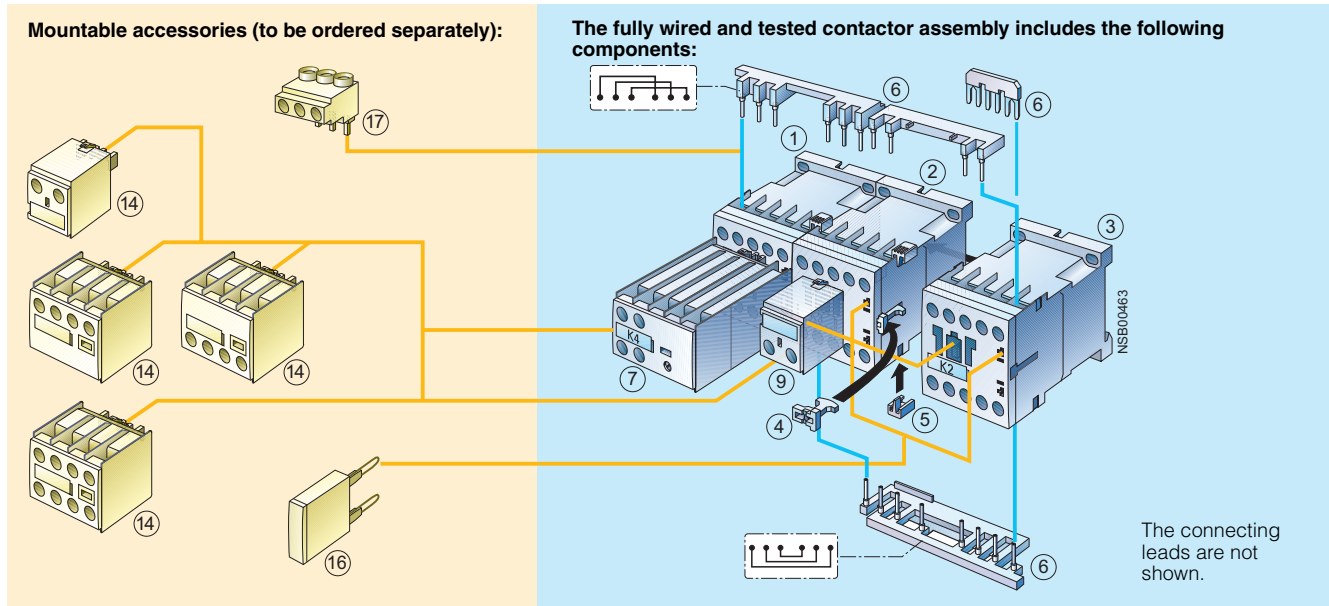

Accessories	Order No.	Page	Individual parts	Order No.			Page
				K1 ¹⁾	K3 ²⁾	K2 ²⁾	
14 Auxiliary switch block, front	3RH19 11-1....	3/110	1 2 3 Contactors, 5.5 kW	3RT10 15	3RT10 15	3RT10 15	3/12
16 Surge suppressors	3RT19 16-1....	3/119, 3/120	1 2 3 Contactors, 7.5 kW	3RT10 17	3RT10 17	3RT10 15	3/12
17 3-phase line-side terminal	3RA19 13-3K	3/53	7 Solid-state time-delay auxiliary switch block, front		3RT19 16-2G.51		3/117
			9 Auxiliary switch block with 1 unassigned NO contact		3RH19 11-1BA10		3/110
			4 5 6 Installation kit		3RA19 13-2B		3/53
			The installation kit contains:				
			4 Mechanical interlock				
			5 3 connecting clips				
			6 Wiring connectors on the top and bottom for connecting the main and control conducting paths				

1) Use version with 1 NO.
2) Use version with 1 NC.

* You can order this quantity or a multiple thereof.

3RA13, 3RA14 Contactor Assemblies

3RA14 Contactor Assemblies for Wye-Delta Starting

3RA14 complete units, 3 ... 75 kW

Size S0-S0-S0 · up to 18.5 kW

Rated data AC-3		Rated control supply voltage U_s ¹⁾		DT	Fully wired and tested contactor assemblies	PU (UNIT, SET, M)	PS*	PG	Weight per PU approx.		
Operational current I_e up to	Ratings of induction motors at 50 Hz and				Order No.	Price per PU			kg		
400 V	230 V	400 V	500 V	690 V							
A	kW	kW	kW	kW	V						
AC operation, 50/60 Hz											
25	7.1	11	15.6	19	24 AC	C	3RA14 23-8XC21-1AC2	1	1 unit	101	1.760
					110 AC	C	3RA14 23-8XC21-1AG2	1	1 unit	101	1.760
					230 AC	▶	3RA14 23-8XC21-1AL2	1	1 unit	101	1.779
32 / 40	11.4	15 / 18.5	19	19	24 AC	C	3RA14 25-8XC21-1AC2	1	1 unit	101	1.740
					110 AC	C	3RA14 25-8XC21-1AG2	1	1 unit	101	1.735
					230 AC	▶	3RA14 25-8XC21-1AL2	1	1 unit	101	1.771
DC operation											
25	7.1	11	15.6	19	24 DC	▶	3RA14 23-8XC21-1BB4	1	1 unit	101	2.385
32 / 40	11.4	15 / 18.5	19	19	24 DC	▶	3RA14 25-8XC21-1BB4	1	1 unit	101	2.448

1) Coil operating range at 50 Hz:
0.8 ... 1.1 x U_s ; at 60 Hz: 0.85 ... 1.1 x U_s .

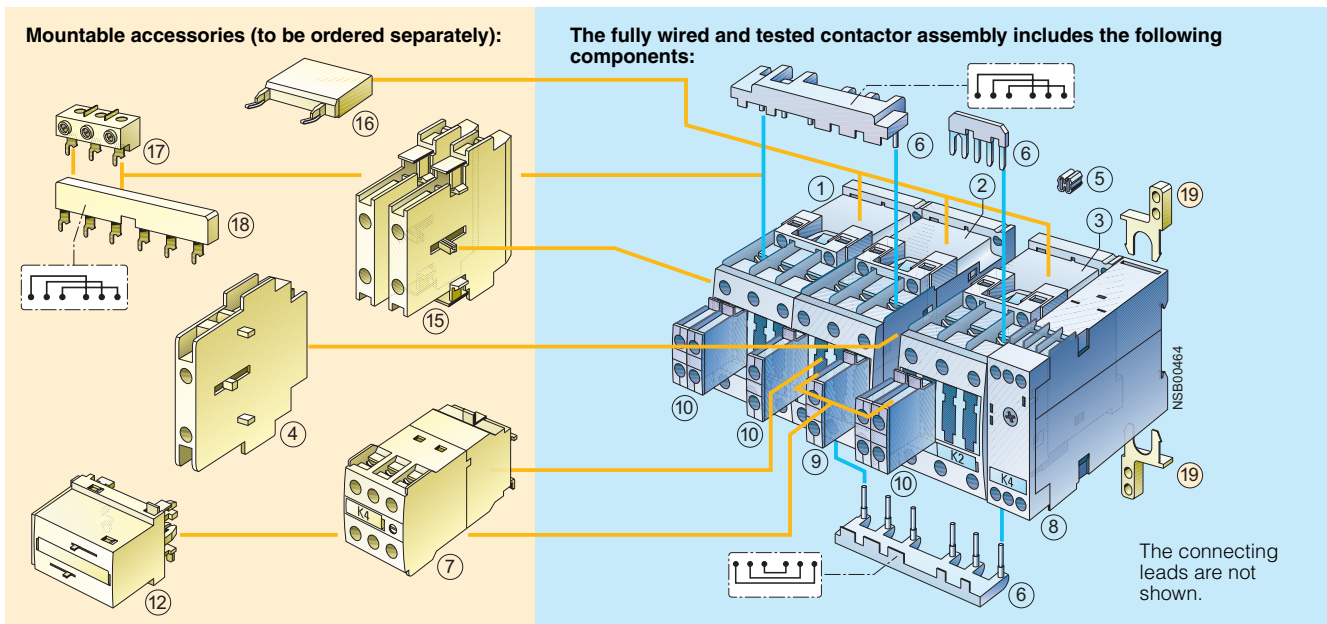

Accessories	Order No.	Page	Individual parts	Order No.			Page
				K1	K3	K2	
④ Mechanical interlock, lateral	3RA19 24-2B	3/43	①②③ Contactors, 11 kW	3RT10 24	3RT10 24	3RT10 24	3/14
⑦ Solid-state time-delay auxiliary switch block, front ¹⁾	3RT19 26-2G...	3/117	①②③ Contactors, 15/18.5 kW	3RT10 26	3RT10 26	3RT10 24	3/14
⑫ Mechanical interlock, front	3RA19 24-1A	3/43	⑧ Timing relay, lateral	3RP15 74-1N.30			4)
⑮ Auxiliary switch block, lateral	3RH19 21-1EA..	3/114	⑨ Auxiliary switch block with 1 unassigned NO contact	3RH19 21-1CA10			3/112
⑯ Surge suppressors	3RT19 26-1....	3/119	⑩ Auxiliary switch block for local control				
⑰ 3-phase line-side terminal ²⁾	3RV19 15-5A	3/53		2 units	3RH19 21-1CA01		
⑱ 3-phase busbar ²⁾	3RT19 26-4CC20	3/53		3 units	3RH19 21-1CA10		3/112
⑲ Push-in lug ³⁾ for timing relay screw mounting	3RP19 03	4)	⑤⑥ Installation kit	3RA19 23-2B			3/53

The installation kit contains:

- ⑤ Connecting clips
- ⑥ Wiring connectors on the top and bottom for connecting the main and control conducting paths

1) Generally possible. If a solid-state time-delay auxiliary switch block is mounted onto the front of K3, a standard auxiliary switch block can only be mounted onto the side.
2) ⑰ and ⑱ can only be mounted with contactors with screw terminal (coil).

3) Not part of the scope of supply of the preassembled contactor assemblies; can be ordered as an accessory.
4) See Monitoring and Control Devices: 3RP, 7PV timing relays -> 3RP15 timing relays in 22.5 mm industrial enclosure.

* You can order this quantity or a multiple thereof.

3RA13, 3RA14 Contactor Assemblies

3RA14 Contactor Assemblies for Wye-Delta Starting

3RA14 complete units, 3 ... 75 kW

Size S2-S2-S0 · up to 30 kW



Rated data AC-3		Rated control supply voltage U_s ¹⁾	DT	Fully wired and tested contactor assemblies	PU (UNIT, SET, M)	PS*	PG	Weight per PU approx.
Operational current I_e up to	Ratings of induction motors at 50 Hz and			Order No.	Price per PU			kg
400 V	230 V	400 V	500 V	690 V				
A	kW	kW	kW	kW	V			
AC operation, 50/60 Hz								
50 / 65	19.6	22 / 30	35	34	230 AC	▶	3RA14 34-8XC21-1AL2	1 1 unit 101 3.070
					24 AC	C	3RA14 34-8XC21-1AC2	1 1 unit 101 3.140
					110 AC	C	3RA14 34-8XC21-1AG2	1 1 unit 101 3.120
DC operation								
50 / 65	19.6	22 / 30	35	34	24 DC	▶	3RA14 34-8XC21-1BB4	1 1 unit 101 4.520

1) Coil operating range at 50 Hz: 0.8 ... 1.1 x U_s ; at 60 Hz: 0.85 ... 1.1 x U_s .

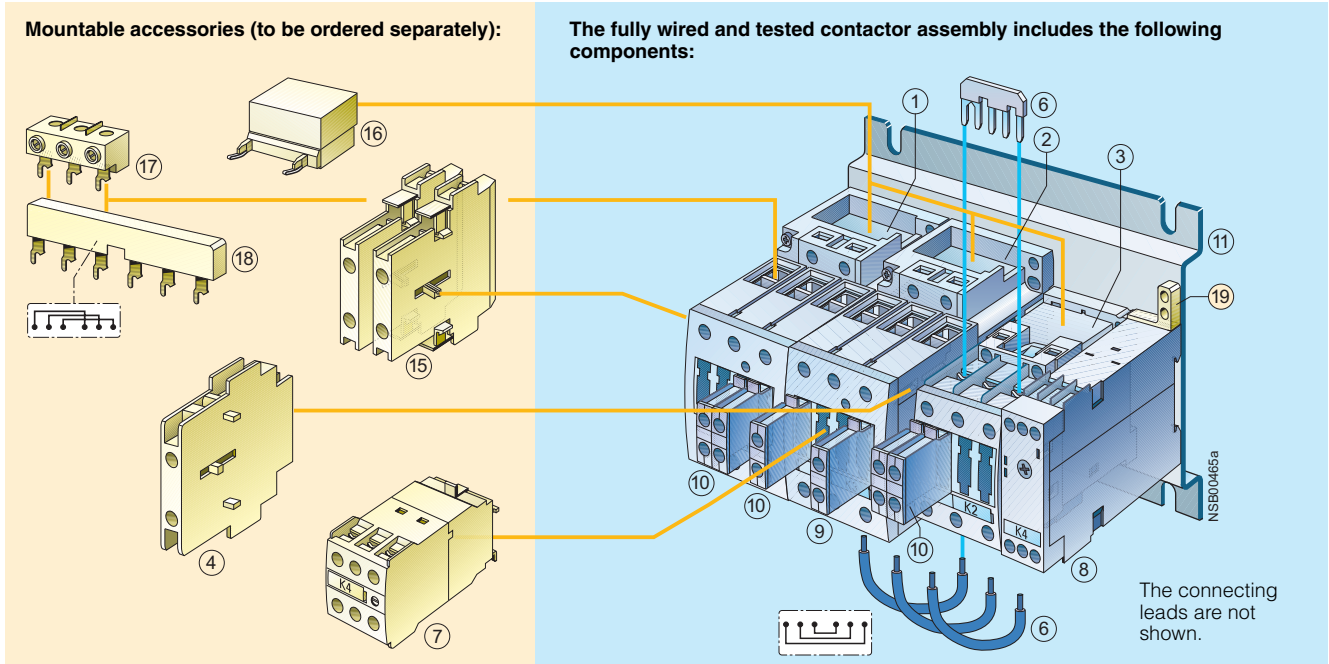

Accessories	Order No.	Page	Individual parts	Order No.			Page
				K1	K3	K2	
④ Mechanical interlock, lateral Depth compensation required K3: 1.5 mm; K2: 0 mm ¹⁾	3RA19 24-2B	3/43	①②③ Contactors, 22/30 kW	3RT10 34	3RT10 34	3RT10 26	3/14
⑦ Solid-state time-delay auxiliary switch block, front ²⁾	3RT19 26-2G...	3/117	⑧ Timing relay, lateral	3RP15 74-1N.30			4)
⑮ Auxiliary switch block, lateral	3RH19 21-1EA..	3/114	⑨ Auxiliary switch block with 1 unassigned NO contact	3RH19 21-1CA10			3/112
⑯ Surge suppressors	3RT19 26-1.... 3RT19 36-1....	3/119, 3/120	⑩ Auxiliary switch block for local control	3RH19 21-1CA01 3RH19 21-1CA10			3/112
⑰ 3-phase line-side terminal	3RV19 35-5A	3/53	⑪ Base plate	3RA19 32-2E			3/53
⑱ Three-phase busbar	3RV19 35-1A	3/53	⑫ Installation kit	3RA19 33-2C			3/53
⑲ Push-in lug ³⁾ for timing relay screw mounting	3RP19 03	4)	The installation kit contains the star jumper on the top and the wiring jumper on the bottom for connecting the main conducting paths.				

- 1) Use the 3RA19 32-2B base plate for this configuration.
- 2) Generally possible. If a solid-state time-delay auxiliary switch block is mounted onto the front of K3, a standard auxiliary switch block can only be mounted onto the side.
- 3) Not part of the scope of supply of the preassembled contactor assemblies; can be ordered as an accessory.
- 4) See Monitoring and Control Devices: 3RP, 7PV timing relays -> 3RP15 timing relays in 22.5 mm industrial enclosure.

* You can order this quantity or a multiple thereof.

3RA13, 3RA14 Contactor Assemblies

3RA14 Contactor Assemblies for Wye-Delta Starting

3RA14 complete units, 3 ... 75 kW

Size S2-S2-S2 · up to 45 kW



Rated data AC-3		Rated control supply voltage $U_s^{(1)}$	DT	Fully wired and tested contactor assemblies	PU (UNIT, SET, M)	PS*	PG	Weight per PU approx.
Operational current I_e up to	Ratings of induction motors at 50 Hz and				Order No.	Price per PU		
400 V	230 V	400 V	500 V	690 V				kg
A	kW	kW	kW	kW	V			
AC operation, 50/60 Hz								
80	25	37	51	63	24 AC	C	3RA14 35-8XC21-1AC2	1 1 unit 101 3.725
					110 AC	C	3RA14 35-8XC21-1AG2	1 1 unit 101 3.665
					230 AC	▶	3RA14 35-8XC21-1AL2	1 1 unit 101 3.650
86	27	45	55	63	24 AC	C	3RA14 36-8XC21-1AC2	1 1 unit 101 3.750
					110 AC	C	3RA14 36-8XC21-1AG2	1 1 unit 101 3.710
					230 AC	▶	3RA14 36-8XC21-1AL2	1 1 unit 101 3.685
DC operation								
80	25	37	51	63	24 DC	B	3RA14 35-8XC21-1BB4	1 1 unit 101 5.515
86	27	45	55	63	24 DC	B	3RA14 36-8XC21-1BB4	1 1 unit 101 5.482

1) Coil operating range at 50 Hz: 0.8 ... 1.1 x U_s ; at 60 Hz: 0.85 ... 1.1 x U_s .

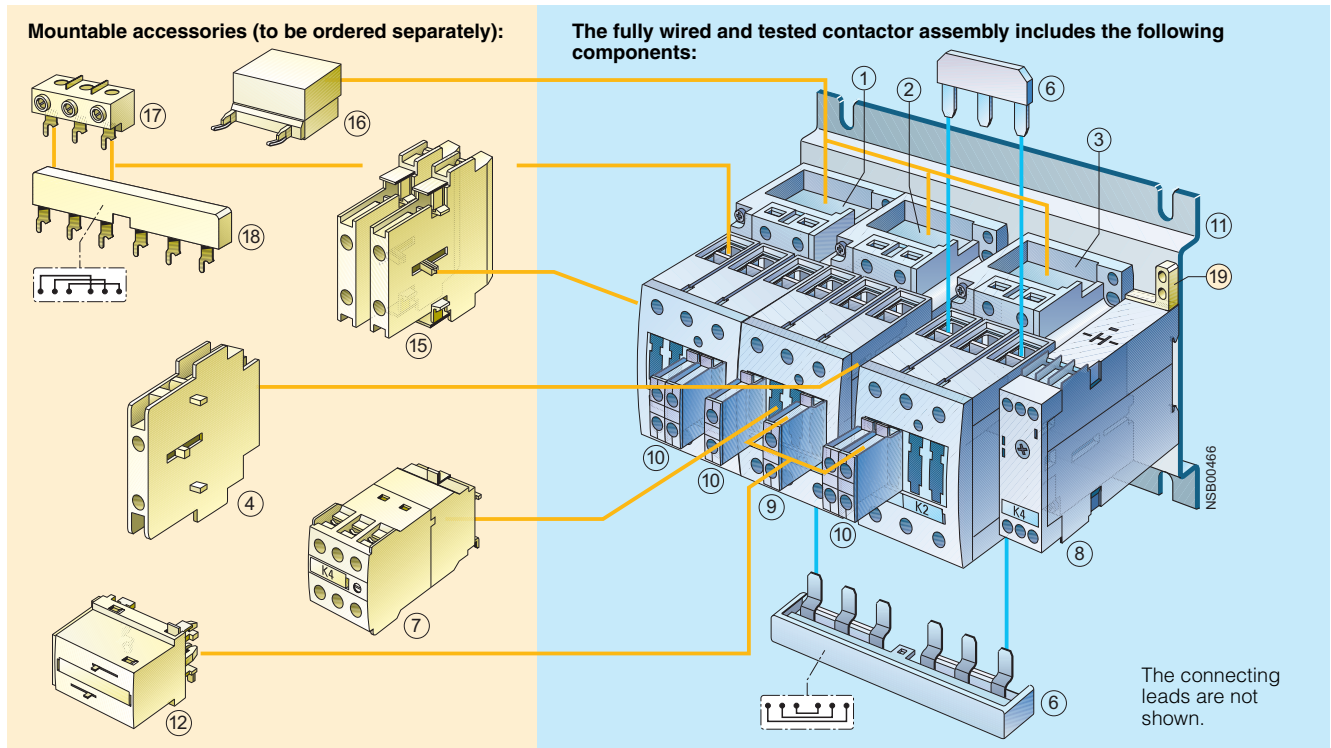

Accessories	Order No.	Page	Individual parts	Order No.			Page
				K1	K3	K2	
④ Mechanical interlock, lateral	3RA19 24-2B	3/43	①②③ Contactors, 37 kW	3RT10 35	3RT10 35	3RT10 34	3/16
⑦ Solid-state time-delay auxiliary switch block, front ¹⁾	3RT19 26-2G...	3/117	①②③ Contactors, 45 kW	3RT10 36	3RT10 36	3RT10 34	3/16
⑫ Mechanical interlock, front	3RA19 24-1A	3/43	⑧ Timing relay, lateral	3RP15 74-1N.30			3)
⑮ Auxiliary switch block, lateral	3RH19 21-1EA..	3/114	⑨ Auxiliary switch block with 1 unassigned NO contact	3RH19 21-1CA10			3/112
⑯ Surge suppressors	3RT19 26-1.... 3RT19 36-1....	3/119, 3/120	⑩ Auxiliary switch block for local control	3RH19 21-1CA01 3RH19 21-1CA10			3/112
⑰ 3-phase line-side terminal	3RV19 35-5A	3/53					
⑱ Three-phase busbar	3RV19 35-1A	3/53	⑪ Base plate	3RA19 32-2F			3/53
			⑫ Installation kit	3RA19 33-2B			3/53

1) Generally possible. If a solid-state time-delay auxiliary switch block is mounted onto the front of K3, a standard auxiliary switch block can only be mounted onto the side.

2) Not part of the scope of supply of the preassembled contactor assemblies; can be ordered as an accessory.

3) See Monitoring and Control Devices: 3RP, 7PV timing relays -> 3RP15 timing relays in 22.5 mm industrial enclosure.

* You can order this quantity or a multiple thereof.

3RA13, 3RA14 Contactor Assemblies

3RA14 Contactor Assemblies for Wye-Delta Starting

3RA14 complete units, 3 ... 75 kW

Size S3-S3-S2 · up to 75 kW



Rated data AC-3		Rated control supply voltage $U_s^{1)}$	DT	Fully wired and tested contactor assemblies		PU (UNIT, SET, M)	PS*	PG	Weight per PU approx.
Operational current I_e at	Ratings of induction motors at 50 Hz and					Order No.	Price per PU		
400 V	230 V	400 V	500 V	690 V	V				kg
A	kW	kW	kW	kW					
AC operation, 50/60 Hz									
115	37	55	81	93	24 AC	B	3RA14 44-8XC21-1AC2	1 1 unit	101 5.700
115	37	55	81	93	110 AC	B	3RA14 44-8XC21-1AG2	1 1 unit	101 5.680
					230 AC	▶	3RA14 44-8XC21-1AL2	1 1 unit	101 5.826
150	47	75	103	110	24 AC	B	3RA14 45-8XC21-1AC2	1 1 unit	101 5.365
					110 AC	B	3RA14 45-8XC21-1AG2	1 1 unit	101 1.770
					230 AC	▶	3RA14 45-8XC21-1AL2	1 1 unit	101 5.971
DC operation									
115	37	55	81	93	24 DC	B	3RA14 44-8XC21-1BB4	1 1 unit	101 8.520
150	47	75	103	110	24 DC	B	3RA14 45-8XC21-1BB4	1 1 unit	101 8.539

1) Coil operating range at 50 Hz: 0.8 ... 1.1 x U_s ; at 60 Hz: 0.85 ... 1.1 x U_s .

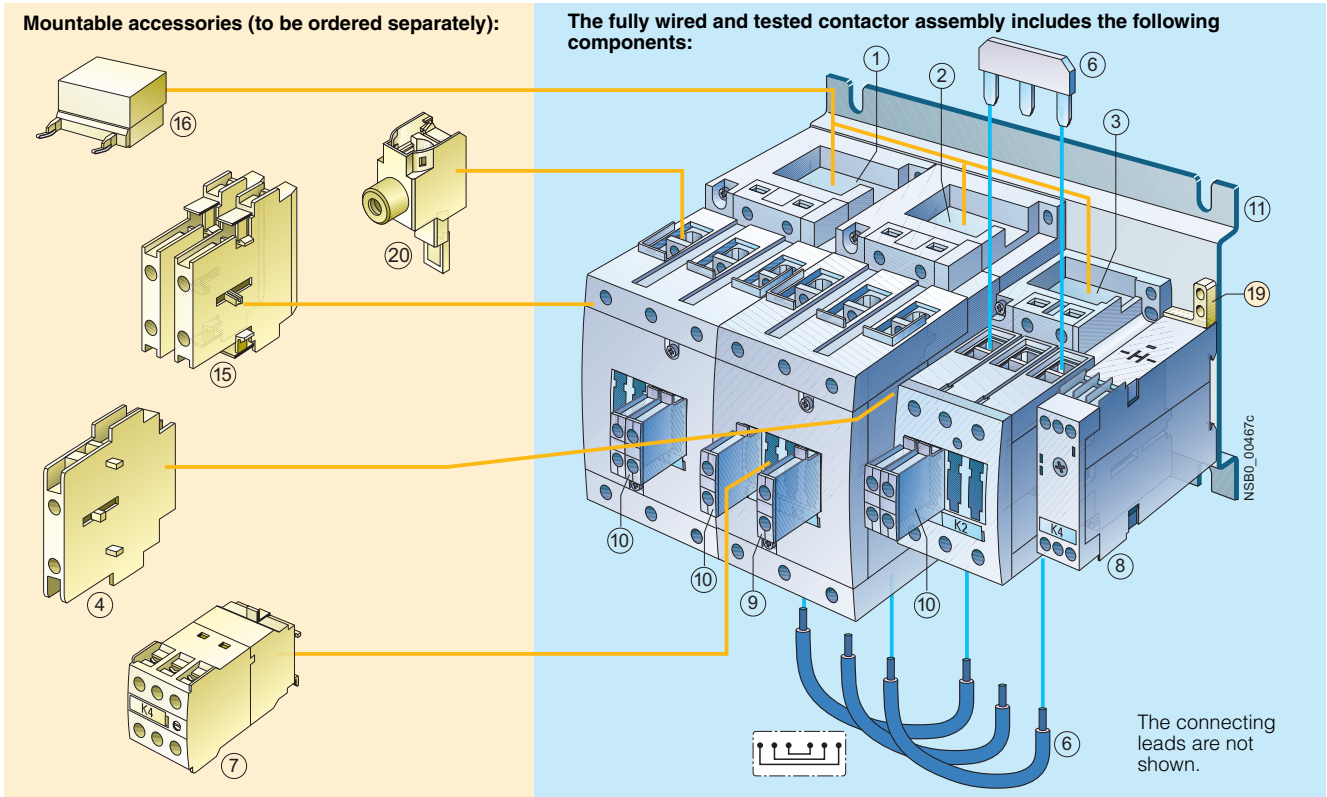

Accessories	Order No.	Page	Individual parts	Order No.			Page
				K1	K3	K2	
④ Mechanical interlock, lateral Depth compensation required K3: 0 mm; K2: 27.5 mm ¹⁾	3RA19 24-2B	3/43	①②③ Contactors, 55 kW ①②③ Contactors, 75 kW ⑧ Timing relay, lateral	3RT10 44 3RT10 45 3RP15 74-1N.30	3RT10 44 3RT10 45	3RT10 35 3RT10 36	3/16 3/16 4)
⑦ Solid-state time-delay auxiliary switch block, front ²⁾	3RT19 26-2G...	3/117	⑨ Auxiliary switch block with 1 unassigned NO contact	3RH19 21-1CA10			3/112
⑮ Auxiliary switch block, lateral	3RH19 21-1EA..	3/114	⑩ Auxiliary switch block for local control	3RH19 21-1CA01 3RH19 21-1CA10			3/112
⑯ Surge suppressors	3RT19 .6-1....	3/119	2 units	3RH19 21-1CA10			
⑰ Push-in lug ³⁾ for timing relay screw mounting	3RP19 03	4)	3 units	3RA19 42-2E			3/53
⑳ 1-phase line-side terminal	3RA19 43-3L	3/53	⑪ Base plate ⑫ Installation kit	3RA19 43-2C			3/53

- 1) Use the 3RA19 42-2B base plate for this configuration.
- 2) Generally possible. If a solid-state time-delay auxiliary switch block is mounted onto the front of K3, a standard auxiliary switch block can only be mounted onto the side.
- 3) Not part of the scope of supply of the preassembled contactor assemblies; can be ordered as an accessory.
- 4) See Monitoring and Control Devices: 3RP, 7PV timing relays -> 3RP15 timing relays in 22.5 mm industrial enclosure.

* You can order this quantity or a multiple thereof.

3RA13, 3RA14 Contactor Assemblies

3RA14 Contactor Assemblies for Wye-Delta Starting

Components for customer assembly

Selection and ordering data

Version	Size	DT	Order No.	Price per PU	PU (UNIT, SET, M)	PS*	PG	Weight per PU approx. kg
Installation kits								
The installation kit contains: mechanical interlock, 3 connecting clips, star jumper, wiring connectors on the top and bottom	S00-S00-S00	▶	3RA19 13-2B		1	1 set	101	0.048
The installation kit contains: 5 connecting clips, star jumper, wiring connectors on the top and bottom	S0-S0-S0	▶	3RA19 23-2B		1	1 set	101	0.061
The installation kit contains: star jumper, wiring connector on the bottom	S2-S2-S0	▶	3RA19 33-2C		1	1 set	101	0.051
	S2-S2-S2	▶	3RA19 33-2B		1	1 set	101	0.072
	S3-S3-S2	▶	3RA19 43-2C		1	1 set	101	0.139
(Wiring connector on the top is not included in the scope of supply. A double infeed between the line contactor and the delta contactor is recommended.)	S3-S3-S3	▶	3RA19 43-2B		1	1 set	101	0.165
	S6-S6-S6	A	3RA19 53-2B		1	1 set	101	0.843
	S10-S10-S10	A	3RA19 63-2B		1	1 set	101	1.782
	S12-S12-S12	B	3RA19 73-2B		1	1 set	101	2.205
1-phase line-side terminals								
Conductor cross-section: 95 mm ²	S3	A	3RA19 43-3L		1	1 unit	101	0.280
3-phase line-side terminals								
Line-side terminal block for the line contactor for large conductor cross-sections								
Conductor cross-section: 6 mm ²	S00	▶	3RA19 13-3K		1	1 unit	101	0.022
Conductor cross-section: 25 mm ²	S0	▶	3RV19 15-5A		1	1 unit	101	0.043
Conductor cross-section: 50 mm ²	S2	▶	3RV19 35-5A		1	1 unit	101	0.115
Three-phase busbars								
Bridging phase-by-phase of all line-side terminals of the line contactor (K1) and the delta contactor (K3)	S0 S2	D ▶	3RT19 26-4CC20 3RV19 35-1A		1 1	1 unit 1 unit	101 101	0.033 0.140
Links for paralleling, 3-pole (star jumpers)								
Without connection terminal (the links for paralleling can be reduced by one pole)	S00 S0 S2 S3 S6¹⁾ S10, S12¹⁾	▶ ▶ ▶ ▶ ▶ ▶	3RT19 16-4BA31 3RT19 26-4BA31 3RT19 36-4BA31 3RT19 46-4BA31 3RT19 56-4BA31 3RT19 66-4BA31		1 1 1 1 1 1	1 unit 1 unit 1 unit 1 unit 1 unit 1 unit	101 101 101 101 101 101	0.003 0.006 0.015 0.028 0.161 0.533
								
3RT19 26-4BA31								
Base plates								
For customer assembly of contactor assemblies for wye-delta starting with a laterally mounted timing relay	S2, S2, S0 S2, S2, S2 S3, S3, S2	B B B	3RA19 32-2E 3RA19 32-2F 3RA19 42-2E		1 1 1	1 unit 1 unit 1 unit	101 101 101	0.441 0.484 0.668
Side-by-side mounting 10 mm clearance between K3 and K2	S6, S6, S3 S6, S6, S6 S10, S10, S6	B B B	3RA19 52-2E 3RA19 52-2F 3RA19 62-2E		1 1 1	1 unit 1 unit 1 unit	101 101 101	1.805 1.945 3.177
10 mm clearance between K1, K3 and K2	S10, S10, S10 S12, S12, S10 S12, S12, S12	B B B	3RA19 62-2F 3RA19 72-2E 3RA19 72-2F		1 1 1	1 unit 1 unit 1 unit	101 101 101	3.392 3.597 3.681
For customer assembly of contactor assemblies for wye-delta starting with a front-mounted timing relay, 10 mm clearance between K1, K3 and K2	S2, S2, S0 S2, S2, S2 S3, S3, S2	B B B	3RA19 32-2B 3RA19 32-2B 3RA19 42-2B		1 1 1	1 unit 1 unit 1 unit	101 101 101	0.429 0.429 0.707

1) The 3RT19 56-4EA1 (S6) or 3RT19 66-4EA1 (S10, S12) cover can be used for touch protection.

3TD, 3TE Contactor Assemblies

3TD6 reversing contactor assemblies, 335 kW

Overview

The contactor assemblies are suitable for use in any climate and the contactors are mechanically interlocked. They are finger-safe according to EN 50274.

Complete units and components for customer assembly are available. For motor protection, either overload relays for individual mounting or thermistor motor protection trip units must be ordered separately.

Complete units

3TD68 contactor assemblies each consist of two mechanically interlocked 3TF68 contactors. Electrical interlocking is wired. The main and control circuits are wired according to the circuit diagrams.

An internal circuit diagram, a type designation and an identification plate are provided on a common cover.

Auxiliary contacts

The contactor assemblies each have 2 NO + 2 NC contacts per contactor. 1 NO + 1 NC contacts with momentary-contact operation and 2 NO + 1 NC contacts with continuous operation are unassigned.

Selection and ordering data

Size	Rated data AC-3	Auxiliary contacts per direction of rotation	Rated control supply voltage U_s	DT	Order No.	Price per PU	PU (UNIT, SET, M)	PS*	PG	Weight per PU approx.
	Operational current I_e up to 690 V A	Ratings of induction motors at 50 Hz and 230 V 400 V 500 V 690 V kW kW kW kW	Version NO NC	V AC						kg

Complete units

AC operation, 50/60 Hz

14	630	200	335	434	600	4	4	110 ... 132 200 ... 240	C C	3TD68 04-2CF7 3TD68 04-2CM7	1 1	1 unit 1 unit	101 101	56.000 54.000
----	-----	-----	-----	-----	-----	---	---	----------------------------	--------	--------------------------------	--------	------------------	------------	------------------

3TD, 3TE Contactor Assemblies

**3TE6 contactor assemblies for
wye-delta starting, 630 kW**

Overview

The contactor assemblies are suitable for use in any climate. They are finger-safe according to EN 50274.

3TE contactor assemblies are available as complete units and components for customer assembly.

The complete units are optionally supplied without a main conducting path connection between the line contactor and the delta contactor.

Motor protection

3TE68 contactor assemblies are supplied without overload protection. Overload relays or thermistor motor protection trip units must be ordered separately.

The overload relay can be either mounted onto the line contactor or separately fitted. It must be set to 0.58 times the rated motor current.

Selection and ordering data

Size	Rated data AC-3		Rated control supply voltage U_s		DT	Order No.	Price per PU	PU (UNIT, SET, M)	PS*	PG	Weight per PU approx.	
	Operational current I_e up to	Ratings of induction motors at 50 Hz and										
	690 V	230 V	400 V	500 V	690 V							
	A	kW	kW	kW	kW	V AC					kg	

Complete units, reversing time up to 10 s

AC operation, 50 Hz

Without main conducting path connection between mains and delta contactor

14	1090	315	630	800	1000	110	C	3TE68 04-5CF0	1	1 unit	101	58.000
						230/220 ¹⁾	C	3TE68 04-5CP0	1	1 unit	101	58.000

For motor protection, overload relays for individual mounting must be ordered separately, see Protection Equipment: Overload Relays -> 3RB2 Solid-State Overload Relays.

1) Operating range at 220 V:
0.85 ... 1.15 x U_s ;
lower operating range limit according to IEC 60947.

3RT, 3RH, 3TB, 3TC, 3TH, 3TK Contactors for Special Applications

3RT14 Contactors for Switching Resistive Loads (AC-1)

3-pole, 140 ... 690 A

Overview

AC and DC operation (size S3)

UC operation (AC/DC) (sizes S6 to S12)

IEC 60947, EN 60947 (VDE 0660)

The contactors are suitable for use in any climate. They are finger-safe according to EN 50274.

3RT14 contactors are used for switching resistive loads (AC-1) or as contactors, for example, for variable-speed drives that normally only have to carry the current.

The accessories for the SIRIUS 3RT10 contactors can also be used here.

For more detailed descriptions about the sizes S3 to S12, see [3RT10 Motor Contactors](#).

Selection and ordering data

Size	Rated data AC-1, $T_U: 40\text{ °C}$	Rated control supply voltage U_s	DT	Order No.	Price per PU	PU (UNIT, SET, M)	PS*	PG	Weight per PU approx.
	Operational current I_e	Ratings of AC loads (p.f. = 0.95) at							
	up to 690 V	230 V 400 V 500 V 690 V							
A		kW kW kW kW V							kg

With screw terminals · for screwing and snapping onto 35 mm and 75 mm standard mounting rails



3RT14 46-1A..0

AC operation		DC operation · DC solenoid system						
S3	140	53 92 115 159	24 AC, 50 Hz B 110 AC, 50 Hz B 230 AC, 50 Hz ▶	3RT14 46-1AB00 3RT14 46-1AF00 3RT14 46-1AP00	1 1 1	1 unit 1 unit 1 unit	101 101 101	1.850 1.828 1.834
S3	140	53 92 115 159	24 DC 220 DC	▶ 3RT14 46-1BB40 B 3RT14 46-1BM40	1 1	1 unit 1 unit	101 101	2.835 2.779

3RT, 3RH, 3TB, 3TC, 3TH, 3TK Contactors for Special Applications

3RT14 Contactors for Switching Resistive Loads (AC-1)

3-pole, 140 ... 690 A

AC/DC operation (40 Hz to 60 Hz, DC)

Auxiliary and control conductors: screw terminals

Withdrawable coils

Integrated coil circuit (varistor)

Main conductors: bar connections

Size	Rated data AC-1, T_U : 40 °C	Auxiliary contacts	Rated control supply voltage U_s	DT	Order No.	Price per PU	PU (UNIT, SET, M)	PS*	PG	Weight per PU approx				
Operational current I_e up to 690 V A		Ratings of AC loads (p.f. = 0.95) at				Version								
		230 V kW	400 V kW	500 V kW	690 V kW	NO	NC	V						
Conventional operating mechanism														
	S6 275	105	180	225	310	2	2	110 ... 127 220 ... 240	▶	3RT14 56-6AF36 3RT14 56-6AP36	1 1	1 unit 1 unit	101 101	3.360 3.330
	S10 400	151	263	329	454	2	2	110 ... 127	▶	3RT14 66-6AF36	1	1 unit	101	6.586
								220 ... 240	▶	3RT14 66-6AP36	1	1 unit	101	6.551
	S12 690	261	454	568	783	2	2	110 ... 127	A	3RT14 76-6AF36	1	1 unit	101	10.465
								220 ... 240	▶	3RT14 76-6AP36	1	1 unit	101	10.366
	Solid-state operating mechanism · for 24 V DC PLC output													
	S6 275	105	180	225	310	2	2	96 ... 127	B	3RT14 56-6NF36	1	1 unit	101	3.327
								200 ... 277	A	3RT14 56-6NP36	1	1 unit	101	3.400
	S10 400	151	263	329	454	2	2	96 ... 127	B	3RT14 66-6NF36	1	1 unit	101	12.569
								200 ... 277	A	3RT14 66-6NP36	1	1 unit	101	6.550
	S12 690	261	454	568	783	2	2	96 ... 127	B	3RT14 76-6NF36	1	1 unit	101	10.489
								200 ... 277	A	3RT14 76-6NP36	1	1 unit	101	10.192
Solid-state operating mechanism · for 24 V DC PLC output/PLC relay output, with indication of remaining lifetime (RLT)														
	S6 275	105	180	225	310	1	1	96 ... 127	B	3RT14 56-6PF35	1	1 unit	101	3.895
								200 ... 277	B	3RT14 56-6PP35	1	1 unit	101	4.197
	S10 400	151	263	329	454	1	1	200 ... 277	B	3RT14 66-6PP35	1	1 unit	101	5.700
								200 ... 277	B	3RT14 76-6PP35	1	1 unit	101	10.650
	S12 690	261	454	568	783	1	1	200 ... 277	B	3RT14 76-6PP35	1	1 unit	101	10.650
								200 ... 277	B	3RT14 76-6PP35	1	1 unit	101	10.650
Solid-state operating mechanism · with AS-Interface and indication of remaining lifetime (RLT)														
	S6 275	105	180	225	310	1	1	96 ... 127	B	3RT14 56-6QF35	1	1 unit	101	3.100
								200 ... 277	B	3RT14 56-6QP35	1	1 unit	101	3.100
	S10 400	151	263	329	454	1	1	200 ... 277	B	3RT14 66-6QP35	1	1 unit	101	10.200
								200 ... 277	B	3RT14 76-6QP35	1	1 unit	101	6.459
	S12 690	261	454	568	783	1	1	200 ... 277	B	3RT14 76-6QP35	1	1 unit	101	6.459
								200 ... 277	B	3RT14 76-6QP35	1	1 unit	101	6.459

For other voltages, see page 3/29.

For accessories, see page 3/112.

For spare parts, see page 3/126.

3RT, 3RH, 3TB, 3TC, 3TH, 3TK Contactors for Special Applications

3RT13 Contactors for Switching Resistive Loads (AC-1)

4-pole, 4 NO, 18 ... 140 A

Overview

AC and DC operation

EN 60947-4-1 (VDE 0660, Part 102)

The contactors are suitable for use in any climate. They are finger-safe according to EN 50274.

The accessories for the 3-pole SIRIUS contactors can also be used for the 4-pole versions.

Selection and ordering data

AC operation, 4 NO contacts Screw terminals

Rated data AC-1, T_U : 40/60 °C	Rated control supply voltage U_s	DT	Screw terminals	PU (UNIT, SET, M)	PS*	PG	Weight per PU approx.
Operational current I_e	Ratings of AC loads (p.f. = 0.95) at 50 Hz and 400 V kW	V	Order No.	Price per PU			kg
A							

For screw and snap-on mounting onto 35 mm standard mounting rails

Size S00¹⁾

18 / 16	12 / 11	24, 50/60 Hz	▶	3RT13 16-1AB00	1	1 unit	101	0.206
		110, 50/60 Hz	▶	3RT13 16-1AF00	1	1 unit	101	0.204
		230, 50/60 Hz	▶	3RT13 16-1AP00	1	1 unit	101	0.203
22 / 20	14.5 / 13	24, 50/60 Hz	▶	3RT13 17-1AB00	1	1 unit	101	0.205
		110, 50/60 Hz	▶	3RT13 17-1AF00	1	1 unit	101	0.203
		230, 50/60 Hz	▶	3RT13 17-1AP00	1	1 unit	101	0.203

Size S0

35 / 30 ²⁾	22 / 20	24, 50 Hz	▶	3RT13 25-1AB00	1	1 unit	101	0.393
		110, 50 Hz	▶	3RT13 25-1AF00	1	1 unit	101	0.392
		230, 50 Hz	▶	3RT13 25-1AP00	1	1 unit	101	0.394
40 / 35 ²⁾	26 / 23	24, 50 Hz	▶	3RT13 26-1AB00	1	1 unit	101	0.393
		110, 50 Hz	▶	3RT13 26-1AF00	1	1 unit	101	0.391
		230, 50 Hz	▶	3RT13 26-1AP00	1	1 unit	101	0.394



3RT13 1.-1A.00



3RT13 2.-1A.00

Size S00:

Sizes S0 to S3:

Snap-on auxiliary switch blocks according to EN 50005.

Snap-on auxiliary switch blocks according to EN 50012 and EN 50005
(for S0 max. 2 auxiliary contacts, please note information in the Catalog LV 1 T).

[For other voltages, see page 3/29.](#)

[For accessories, see page 3/110.](#)

[For spare parts, see page 3/126.](#)

1) For size S00: coil operating range
at 50 Hz: 0.8 ... 1.1 x U_s
at 60 Hz: 0.85 ... 1.1 x U_s .

2) Minimum conductor cross-section 10 mm².

AC operation, 4 NO contacts Cage Clamp terminals

Rated data AC-1, T_U : 40/60 °C	Rated control supply voltage U_s	DT	Cage Clamp terminals	PU (UNIT, SET, M)	PS*	PG	Weight per PU approx.
Operational current I_e	Ratings of AC loads (p.f. = 0.95) at 50 Hz and 400 V kW	V	Order No.	Price per PU			kg
A							

For screw and snap-on mounting onto 35 mm standard mounting rails

Size S00¹⁾

18 / 16	12 / 11	24, 50/60 Hz	B	3RT13 16-2AB00	1	1 unit	101	0.202
		110, 50/60 Hz	B	3RT13 16-2AF00	1	1 unit	101	0.198
		230, 50/60 Hz	▶	3RT13 16-2AP00	1	1 unit	101	0.202
22 / 20	14.5 / 13	24, 50/60 Hz	B	3RT13 17-2AB00	1	1 unit	101	0.201
		110, 50/60 Hz	B	3RT13 17-2AF00	1	1 unit	101	0.200
		230, 50/60 Hz	▶	3RT13 17-2AP00	1	1 unit	101	0.201

Size S00:

Snap-on auxiliary switch blocks according to EN 50005.

[For other voltages, see page 3/29.](#)

[For accessories, see page 3/110.](#)

[For spare parts, see page 3/127.](#)

1) For size S00: coil operating range
at 50 Hz: 0.8 ... 1.1 x U_s
at 60 Hz: 0.85 ... 1.1 x U_s .

* You can order this quantity or a multiple thereof.

3RT, 3RH, 3TB, 3TC, 3TH, 3TK Contactors for Special Applications

3RT13 Contactors for Switching Resistive Loads (AC-1)

4-pole, 4 NO, 18 ... 140 A

AC and DC operation, 4 NO contacts
Screw terminals

Rated data AC-1, T_U : 40/60 °C	Rated control supply voltage U_s	DT	Screw terminals	PU (UNIT, SET, M)	PS*	PG	Weight per PU approx.
Operational current I_e	Ratings of AC loads (p.f. = 0.95) at 50 Hz and 400 V		Order No.	Price per PU			
A	kW	V					kg

For screw and snap-on mounting onto 35 mm standard mounting rails

AC operation

Size S2

60 / 55	39 / 36	24 AC, 50 Hz	B	3RT13 36-1AB00	1	1 unit	101	0.989
		110 AC, 50 Hz	B	3RT13 36-1AF00	1	1 unit	101	0.994
		230 AC, 50 Hz	▶	3RT13 36-1AP00	1	1 unit	101	0.985

Size S3

110 / 100	72 / 66	24 AC, 50 Hz	B	3RT13 44-1AB00	1	1 unit	101	2.200
		110 AC, 50 Hz	B	3RT13 44-1AF00	1	1 unit	101	2.194
		230 AC, 50 Hz	▶	3RT13 44-1AP00	1	1 unit	101	2.170

140 / 120	92 / 79	24 AC, 50 Hz	B	3RT13 46-1AB00	1	1 unit	101	2.188
		110 AC, 50 Hz	B	3RT13 46-1AF00	1	1 unit	101	2.208
		230 AC, 50 Hz	▶	3RT13 46-1AP00	1	1 unit	101	2.168

DC operation · DC solenoid system

Size S00

18 / 16	12 / 11	24 DC	▶	3RT13 16-1BB40	1	1 unit	101	0.264
		220 DC	B	3RT13 16-1BM40	1	1 unit	101	0.262

22 / 20	14.5 / 13	24 DC	▶	3RT13 17-1BB40	1	1 unit	101	0.263
		220 DC	B	3RT13 17-1BM40	1	1 unit	101	0.260

Size S0

35 / 30 ¹⁾	22 / 20	24 DC	▶	3RT13 25-1BB40	1	1 unit	101	0.624
		220 DC	B	3RT13 25-1BM40	1	1 unit	101	0.628

40 / 35 ¹⁾	26 / 23	24 DC	▶	3RT13 26-1BB40	1	1 unit	101	0.625
		220 DC	B	3RT13 26-1BM40	1	1 unit	101	0.630

Size S2

60 / 55	39 / 36	24 DC	▶	3RT13 36-1BB40	1	1 unit	101	1.576
		220 DC	B	3RT13 36-1BM40	1	1 unit	101	1.591

Size S3

110 / 100	72 / 66	24 DC	B	3RT13 44-1BB40	1	1 unit	101	3.183
		220 DC	B	3RT13 44-1BM40	1	1 unit	101	3.135

140 / 120	92 / 79	24 DC	B	3RT13 46-1BB40	1	1 unit	101	3.193
		220 DC	B	3RT13 46-1BM40	1	1 unit	101	3.134

Size S00: snap-on auxiliary switch blocks according to EN 50005

Sizes S0 to S3: snap-on auxiliary switch blocks according to EN 50012 and EN 50005
(for S0 max. 2 auxiliary contacts, please note information in the Catalog LV 1 T).

For other voltages, see page 3/29.

For accessories, see page 3/110.

For spare parts, see page 3/126.

1) Minimum conductor cross-section 10 mm².

3RT, 3RH, 3TB, 3TC, 3TH, 3TK Contactors for Special Applications

3RT13 Contactors for Switching Resistive Loads (AC-1)

4-pole, 4 NO, 18 ... 140 A

DC operation, 4 NO contacts
Cage Clamp terminals

Rated data AC-1, T_U : 40/60 °C	Rated control supply voltage U_s	DT	Cage Clamp terminals	PU (UNIT, SET, M)	PS*	PG	Weight per PU approx.
Operational current I_e	Ratings of AC loads (p.f. = 0.95) at 50 Hz and 400 V kW	V	Order No. Price per PU				kg
A							

For screw and snap-on mounting onto 35 mm standard mounting rails

DC operation · DC solenoid system

Size S00

18 / 16	12 / 11	24 DC	▶	3RT13 16-2BB40	1	1 unit	101	0.260
		220 DC	B	3RT13 16-2BM40	1	1 unit	101	0.253
22 / 20	14.5 / 13	24 DC	A	3RT13 17-2BB40	1	1 unit	101	0.260
		220 DC	B	3RT13 17-2BM40	1	1 unit	101	0.254



3RT13 1.-2B..0

Size S00: snap-on auxiliary switch blocks according to EN 50005

For other voltages, see page 3/29.

For accessories, see page 3/110.

For spare parts, see page 3/127.

3RT, 3RH, 3TB, 3TC, 3TH, 3TK Contactors for Special Applications

3TK1 Contactors for Switching Resistive Loads (AC-1)

4-pole, 4 NO, 200 ... 1000 A

Overview

EN 60947-4-1 (VDE 0660 Part 102)

The contactors also comply with the requirements of NFC 63-110 and NFC 20-040.

The contactors are suitable for use in any climate. They are finger-safe according to EN 50274. Terminal covers may have to be fitted onto the connecting bars, depending on the configuration with other devices.

Solenoids for 3TK10 to 3TK13 contactors: as withdrawable coils.

Surge suppression

Control circuit

Solenoids for 3TK1 contactors: can be retrofitted with RC elements.

Selection and ordering data

Screw terminals
Screw mounting



3TK13

Rated data AC-1		Auxiliary contacts		Rated control supply voltage U_s		DT	Order No.	Price per PU	PU (UNIT, SET, M)	PS*	PG	Weight per PU approx.	
Operational current I_e up to 690 V (at 40 °C) A	Ratings of AC loads (p.f. = 0.95) at				Version		V AC					kg	
	230 V	400 V	690 V	1000 V	NO	NC							
	kW	kW	kW	kW									
AC operation													
200	75	130	225	205	2	2	220 ... 230, 50 Hz 230 ... 240, 50 Hz 110/120, 50/60 Hz 24, 50 Hz	B D C D	3TK10 42-0AP0 3TK10 42-0AU0 3TK10 42-0AF0 3TK10 42-0AB0	1 1 1 1	1 unit 1 unit 1 unit 1 unit	101 101 101 101	4.423 4.449 4.379 4.432
250	90	165	280	200	2	2	220 ... 230, 50 Hz 230 ... 240, 50 Hz 110/120, 50/60 Hz 24, 50 Hz	B D D D	3TK11 42-0AP0 3TK11 42-0AU0 3TK11 42-0AF0 3TK11 42-0AB0	1 1 1 1	1 unit 1 unit 1 unit 1 unit	101 101 101 101	4.746 4.476 4.634 4.738
300	110	195	340	325	2	2	220 ... 230, 50 Hz 230 ... 240, 50 Hz 110/120, 50/60 Hz 24, 50 Hz	B D D D	3TK12 42-0AP0 3TK12 42-0AU0 3TK12 42-0AF0 3TK12 42-0AB0	1 1 1 1	1 unit 1 unit 1 unit 1 unit	101 101 101 101	7.158 7.167 7.127 7.129
350	130	230	395	370	2	2	220 ... 230, 50 Hz 230 ... 240, 50 Hz 110/120, 50/60 Hz 24, 50 Hz	B D D D	3TK13 42-0AP0 3TK13 42-0AU0 3TK13 42-0AF0 3TK13 42-0AB0	1 1 1 1	1 unit 1 unit 1 unit 1 unit	101 101 101 101	7.156 7.172 7.118 7.136
550	205	360	620	510	2	2	220 ... 230, 50 Hz ¹⁾ 230 ... 240, 50 Hz 110/120, 50/60 Hz	B D C	3TK14 42-0AP0 3TK14 42-0AU0 3TK14 42-0AF0	1 1 1	1 unit 1 unit 1 unit	101 101 101	18.938 19.041 19.094
800	300	525	905	575	2	2	220 ... 230, 50 Hz ¹⁾ 230 ... 240, 50 Hz 110/120, 50/60 Hz	B D C	3TK15 42-0AP0 3TK15 42-0AU0 3TK15 42-0AF0	1 1 1	1 unit 1 unit 1 unit	101 101 101	19.068 19.100 19.076
1000	375	655	1135	--	2	2	220 ... 230, 50 Hz ¹⁾ 230 ... 240, 50 Hz 110/120, 50/60 Hz	B D D	3TK17 42-0AP0 3TK17 42-0AU0 3TK17 42-0AF0	1 1 1	1 unit 1 unit 1 unit	101 101 101	20.030 20.080 20.100

For accessories, see page 3/134 onwards.
For spare parts, see page 3/142 onwards.

1) At 60 Hz: 240 V.

3RT, 3RH, 3TB, 3TC, 3TH, 3TK Contactors for Special Applications

3TK20 Contactors

4-pole, 4 kW

Overview

AC and DC operation

IEC 60947 (VDE 0660).

The contactors are suitable for use in any climate.

The contactors with screw terminals are finger-safe according to EN 50274.

The contactors are available in versions with screw terminals, 6.3 mm plug connectors and solder pin connectors for soldering in printed circuit boards.

Application

The main area of application for the 3TK2 contactors with flat connectors is in household equipment. These contactors are also suitable for simple electric controllers. No auxiliary switch blocks can be retrofitted.

Selection and ordering data

Size 00

AC-1: operational current $I_e = 16 A$ (at 55 °C)

Rated data Utilization categories AC-2 and AC-3	Main contacts	DT	Order No.	Price per PU	PU (UNIT, SET, M)	PS*	PG	Weight per PU approx.
Operational current I_e at 400/ 380 V	Ratings of induction motors at 50 Hz and 230/ 400/ 500 V 220 V 380 V	Version NO NC						kg
A	kW kW kW kW							

Contactors with screw terminals for screw and snap-on mounting onto 35 mm standard mounting rail



AC operation

9	2.4	4	4	4	4	--	B	3TK20 40-0AP0	1	1 unit	101	0.190
					3	1	B	3TK20 31-0AP0	1	1 unit	101	0.188
					2	2	B	3TK20 22-0AP0	1	1 unit	101	0.188

DC operation - DC solenoid system

9	2.4	4	4	4	4	--	B	3TK20 40-0BB4	1	1 unit	101	0.210
					3	1	B	3TK20 31-0BB4	1	1 unit	101	0.210
					2	2	B	3TK20 22-0BB4	1	1 unit	101	0.209

3TK20 ...0...

Contactors with 6.3 mm x 0.8 mm flat connectors for screw and snap-on mounting onto 35 mm standard mounting rail



AC operation

9	2.4	4	4	--	4	--	C	3TK20 40-3AP0	1	1 unit	101	0.166
					3	1	C	3TK20 31-3AP0	1	1 unit	101	0.164
					2	2	C	3TK20 22-3AP0	1	1 unit	101	0.180

DC operation - DC solenoid system

9	2.4	4	4	--	4	--	C	3TK20 40-3BB4	1	1 unit	101	0.185
					3	1	C	3TK20 31-3BB4	1	1 unit	101	0.187
					2	2	C	3TK20 22-3BB4	1	1 unit	101	0.189

3TK20 ...3...

Contactors with 6.3 mm x 0.8 mm flat connectors for screw mounting (diagonal)



AC operation

9	2.4	4	4	--	4	--	B	3TK20 40-7AP0	1	1 unit	101	0.161
					3	1	B	3TK20 31-7AP0	1	1 unit	101	0.163
					2	2	B	3TK20 22-7AP0	1	1 unit	101	0.162

DC operation - DC solenoid system

9	2.4	4	4	--	4	--	B	3TK20 40-7BB4	1	1 unit	101	0.183
					3	1	B	3TK20 31-7BB4	1	1 unit	101	0.187
					2	2	B	3TK20 22-7BB4	1	1 unit	101	0.183

3TK20 ...7...

Contactors with solder pin connectors for printed circuit boards¹⁾ for screw mounting (diagonal)



AC operation

9	2.4	4	4	--	4	--	B	3TK20 40-6AP0	1	1 unit	101	0.159
					3	1	B	3TK20 31-6AP0	1	1 unit	101	0.160
					2	2	B	3TK20 22-6AP0	1	1 unit	101	0.159

DC operation - DC solenoid system

9	2.4	4	4	--	4	--	B	3TK20 40-6BB4	1	1 unit	101	0.182
					3	1	B	3TK20 31-6BB4	1	1 unit	101	0.183
					2	2	B	3TK20 22-6BB4	1	1 unit	101	0.181

3TK20 ...6...

For accessories, see page 3/137.

1) Operating range at AC-1
220 V; 0.85 to 1.15 x U_N ; lower operating range limit according to IEC 60947.

* You can order this quantity or a multiple thereof.

3RT, 3RH, 3TB, 3TC, 3TH, 3TK Contactors for Special Applications

3TK20 Contactors

4-pole, 4 kW

Contactor	Type	3TK20
Rated control supply voltages (the 10th and 11th position of the order number must be changed)		
AC operation		
Coils for AC 50 and 60 Hz Rated control supply voltage U_s		
Coils for AC 50 Hz		
50 Hz	60 Hz	
V AC	V AC	
230/220	276	P0¹⁾

1) Operating range at 220 V:
0.85 to 1.15 x U_s ; lower operating range limit according to IEC 60947.

[Please inquire about other voltages.](#)

Contactor	Type	3TK20
Rated control supply voltages (the 10th and 11th position of the order number must be changed)		
DC operation		
Rated control supply voltage U_s		
V DC		
24		B4

3RT, 3RH, 3TB, 3TC, 3TH, 3TK Contactors for Special Applications

3RT15 Contactors

4-pole, 2 NO + 2 NC, 4 ... 18.5 kW

Overview

AC and DC operation

EN 60947-4-1 (VDE 0660, Part 102)

The contactors are suitable for use in any climate. They are finger-safe according to EN 50274.



The accessories for the 3-pole SIRIUS contactors can also be used for the 4-pole versions.

Selection and ordering data

AC and DC operation 2 NO contacts + 2 NC contacts¹⁾ Screw terminals

Rated data AC-2 and AC-3, T_U : up to 60 °C		AC-1, T_U : 40/60 °C	Rated control supply voltage U_s	DT	Screw terminals		PU (UNIT, SET, M)	PS*	PG	Weight per PU approx.
Operational current I_e	Ratings of induction motors at 50 Hz and	Operational current I_e			Order No.	Price per PU				kg
400 V	400 V	A	V							
A	kW	A	V							

For screw and snap-on mounting onto 35 mm standard mounting rails

AC operation										
Size S00 ²⁾										
	9	4	18 / 16	24 AC, 50/60 Hz	B	3RT15 16-1AB00	1	1 unit	101	0.205
				110 AC, 50/60 Hz	B	3RT15 16-1AF00	1	1 unit	101	0.204
				230 AC, 50/60 Hz	▶	3RT15 16-1AP00	1	1 unit	101	0.202
3RT15 17-1...	12	5.5	22 / 20	24 AC, 50/60 Hz	A	3RT15 17-1AB00	1	1 unit	101	0.205
				110 AC, 50/60 Hz	▶	3RT15 17-1AF00	1	1 unit	101	0.203
				230 AC, 50/60 Hz	▶	3RT15 17-1AP00	1	1 unit	101	0.205
	25	11	40 / 35 ³⁾	24 AC, 50 Hz	B	3RT15 26-1AB00	1	1 unit	101	0.395
				110 AC, 50 Hz	▶	3RT15 26-1AF00	1	1 unit	101	0.390
				230 AC, 50 Hz	▶	3RT15 26-1AP00	1	1 unit	101	0.393
3RT15 26-1 .	40	18.5	55 / 50	24 AC, 50 Hz	B	3RT15 35-1AB00	1	1 unit	101	0.983
				110 AC, 50 Hz	B	3RT15 35-1AF00	1	1 unit	101	0.991
				230 AC, 50 Hz	▶	3RT15 35-1AP00	1	1 unit	101	0.984
DC operation · DC solenoid system										
Size S00										
9	4	18 / 16	24 DC 220 DC	▶	3RT15 16-1BB40	1	1 unit	101	0.263	
				B	3RT15 16-1BM40	1	1 unit	101	0.262	
12	5.5	22 / 20	24 DC 220 DC	▶	3RT15 17-1BB40	1	1 unit	101	0.265	
				B	3RT15 17-1BM40	1	1 unit	101	0.259	
Size S0										
20	11	40 / 35 ³⁾	24 DC 220 DC	▶	3RT15 26-1BB40	1	1 unit	101	0.625	
				B	3RT15 26-1BM40	1	1 unit	101	0.626	
Size S2										
40	18.5	55 / 50	24 DC 220 DC	▶	3RT15 35-1BB40	1	1 unit	101	1.583	
				B	3RT15 35-1BM40	1	1 unit	101	1.585	

Size S00: snap-on auxiliary switch blocks according to EN 50005
 Sizes S0 to S3: snap-on auxiliary switch blocks according to EN 50012 and EN 50005
 (for S0 max. 2 auxiliary contacts, please note information in the Catalog LV 1 T).

For other voltages, see page 3/29.
 For accessories, see page 3/110.
 For spare parts, see page 3/126.

- 1) For switching poles; not suitable for reversing duty.
- 2) For size S00: coil operating range
 at 50 Hz: 0.8 ... 1.1 x U_s
 at 60 Hz: 0.85 ... 1.1 x U_s .
- 3) Required conductor cross-section: 10 mm².

* You can order this quantity or a multiple thereof.

3RT, 3RH, 3TB, 3TC, 3TH, 3TK Contactors for Special Applications

3RT15 Contactors

4-pole, 2 NO + 2 NC, 4 ... 18.5 kW

AC and DC operation
2 NO contacts + 2 NC contacts¹⁾
Cage Clamp terminals

Rated data		AC-1, T_U : 40/60 °C	Rated control supply voltage U_s	DT	Cage Clamp terminals		PU (UNIT, SET, M)	PS*	PG	Weight per PU approx.
Operational current I_e	Ratings of induction motors at 50 Hz and	Operational current I_e			Order No.	Price per PU				kg
400 V	400 V									
A	kW	A	V							

For screw and snap-on mounting onto 35 mm standard mounting rails



3RT15 1.-2....

AC operation

Size S00²⁾

9	4	18 / 16	24 AC, 50/60 Hz	B	3RT15 16-2AB00	1	1 unit	101	0.198
			110 AC, 50/60 Hz	B	3RT15 16-2AF00	1	1 unit	101	0.196
			230 AC, 50/60 Hz	▶	3RT15 16-2AP00	1	1 unit	101	0.201
12	5.5	22 / 20	24 AC, 50/60 Hz	B	3RT15 17-2AB00	1	1 unit	101	0.200
			110 AC, 50/60 Hz	B	3RT15 17-2AF00	1	1 unit	101	0.199
			230 AC, 50/60 Hz	▶	3RT15 17-2AP00	1	1 unit	101	0.201

DC operation - DC solenoid system

Size S00

9	4	18 / 16	24 DC	▶	3RT15 16-2BB40	1	1 unit	101	0.260
			220 DC	B	3RT15 16-2BM40	1	1 unit	101	0.256
12	5.5	22 / 20	24 DC	B	3RT15 17-2BB40	1	1 unit	101	0.262
			220 DC	B	3RT15 17-2BM40	1	1 unit	101	0.255

For other voltages, see page 3/29.

For accessories, see page 3/110.

For spare parts, see page 3/127.

1) For switching poles; not suitable for reversing duty.

2) For size S00: coil operating range
 at 50 Hz: 0.8 ... 1.1 x U_s
 at 60 Hz: 0.85 ... 1.1 x U_s .

3RT, 3RH, 3TB, 3TC, 3TH, 3TK Contactors for Special Applications

3RT16 Capacitor Contactors

12.5 ... 50 kvar

Overview

AC operation

IEC 60947, EN 60947 (VDE 0660)

The contactors are suitable for use in any climate. They are finger-safe according to EN 50274.

The 3RT16 capacitor switching contactors are special variants of the size S00 to S3 SIRIUS contactors. The capacitors are precharged by means of the mounted leading NO contacts and resistors; only then do the main contacts close.

This prevents disturbances in the power system and welding of the contactors.

Only discharged capacitors are permitted to be switched on with capacitor contactors.

The auxiliary switch block which is snapped onto the capacitor contactor contains the three leading NO contacts and in the case of S00 one standard NC contact (in addition to one NO contact in the basic unit) and in the case of S0 and S3 one standard NO contact, which is unassigned. Size S00 also contains another unassigned NO contact in the basic unit.

In addition, a 2-pole auxiliary contact block can be mounted laterally on the 3RT16 47 capacitor contactors (2 NO, 2 NC or 1 NO + 1 NC versions); type 3RH19 21-1EA... The fitting of auxiliary switches for 3RT16 17 and 3RT16 27 is not expandable.

For the capacitor making and switching capacity of the basic 3RT10 contactor variant, see Technical Specifications.

Selection and ordering data

AC operation Screw terminals

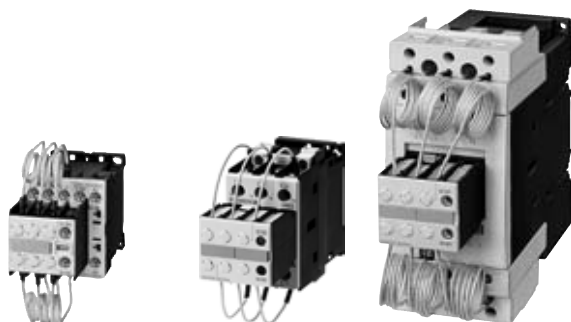

3RT16 17-1A.03

3RT16 27-1A.01

3RT16 47-1A.01

Utilization category AC-6b		Auxiliary contacts, unassigned		Rated control supply voltage $U_s^{(2)}$		DT	Screw terminals		PU (UNIT, SET, M)	PS*	PG	Weight per PU approx.
Switching of AC capacitors for an ambient temperature of 60 °C ¹⁾							Order No.	Price per PU				kg
Capacitor rating at operating voltage 50/60 Hz												
230 V	400 V	525 V	690 V									
kvar	kvar	kvar	kvar	NO	NC	V AC	Hz					

For screw and snap-on mounting onto 35 mm standard mounting rails

Size S00

3 ... 7.5	5 ... 12.5	7.5 ... 15	10 ... 21	1	1	24 110 230	50 / 60	▶ B ▶	3RT16 17-1AB03 3RT16 17-1AF03 3RT16 17-1AP03	1 1 1	1 unit 1 unit 1 unit	101 101 101	0.278 0.276 0.275
-----------	------------	------------	-----------	---	---	------------------	---------	-------------	---	-------------	----------------------------	-------------------	-------------------------

Size S0³⁾

3.5 ... 15	6 ... 25	7.8 ... 30	10 ... 42	1	--	24 110 230	50	B B ▶	3RT16 27-1AB01 3RT16 27-1AF01 3RT16 27-1AP01	1 1 1	1 unit 1 unit 1 unit	101 101 101	0.440 0.430 0.431
------------	----------	------------	-----------	---	----	------------------	----	-------------	---	-------------	----------------------------	-------------------	-------------------------

Size S3

3.5 ... 30	5 ... 50	7.5 ... 60	10 ... 84	1	--	24 110 230	50	B B ▶	3RT16 47-1AB01 3RT16 47-1AF01 3RT16 47-1AP01	1 1 1	1 unit 1 unit 1 unit	101 101 101	2.037 2.040 2.033
------------	----------	------------	-----------	---	----	------------------	----	-------------	---	-------------	----------------------------	-------------------	-------------------------

For other voltages, see page 3/29.

For accessories, see page 3/114.

- 1) For size S3: 55 °C.
- 2) Operating range: 0.85 ... 1.1 x U_s .
- 3) For conductor cross-sections > 6 mm²
Use 3RV19 25-5AB terminals (2 units).

* You can order this quantity or a multiple thereof.

3RT, 3RH, 3TB, 3TC, 3TH, 3TK Contactors for Special Applications

Contactors with Extended Tolerance 0.7 ... 1.25 x U_s, for Railway Applications

3RH11 contactor relays

Overview

DC operation

IEC 60947-4-1, EN 60947-4-1 (VDE 0660, Part 102), for requirements according to IEC 60077-1 and IEC 60077-2.

The contactor relays are finger-safe according to EN 50274. The size S00 contactor relays have Cage Clamp connections for all terminals.

Ambient temperature

The permissible ambient temperature for operation of the contactor relays (across the full coil operating range) is -40 °C to +70 °C.

Uninterrupted duty at temperatures > +55 °C reduces the mechanical endurance, the current-carrying capacity of the conducting paths and the operating frequency.

Application

For operation in installations which are subject both to considerable variations in the control voltage and to high ambient temperatures, e.g. railway applications under extreme climatic conditions, rolling mills, etc.

Control and auxiliary circuits

The coils of the contactor relays have an extended tolerance from 0.7 to 1.25 x U_s and are fitted as standard with varistors to provide protection against voltage surges. The opening delay is consequently 2 to 5 ms longer than for standard contactors.

3RH11..-0LAO

The DC solenoid systems of the contactor relays are modified (to hold-in coil) by means of a series resistor.

The size S00 contactor relays are supplied prewired with a plug-on module containing the series resistor. The varistor is integrated. A 4-pole auxiliary switch block (according to EN 50005) can be fitted additionally.

Mounting

At ambient temperatures up to 70 °C, the size S00 contactor relays are allowed to be mounted side by side.

3RH1122-2K.40

These contactor relays have an extended tolerance from 0.7 to 1.25 x U_s; the coils are fitted with varistors as standard. An additional series resistor is not required. Please note:

- Size S00: It is not possible to mount an auxiliary switch block.

At ambient temperatures > 60 °C ≤ 70 °C, a clearance of 10 mm is required when they are mounted side by side.

Selection and ordering data

DC operation · DC solenoid system

Cage Clamp terminals

For screw and snap-on mounting onto standard mounting rail

Solenoid fitted with varistor



3RH11 22-2K.40:



3RH11 22-2K.40-0LAO

Rated operational current				Contacts		Rated control supply voltage U _s	DT	Cage Clamp terminals	PU (UNIT, SET, M)	PS*	PG	Weight per PU approx.
I _e /AC-15/AC-14 T _u : 70 °C at				Version		V DC		Order No.	Price per PU			kg
230 V	400 V	500 V	690 V	NO	NC							
A	A	A	A									

3RH11 contactor relays

Size S00

Cage Clamp terminals for all connections

6	3	2	1	2	2 ¹⁾	24 ²⁾ 110 ²⁾	▶	3RH11 22-2KB40 3RH11 22-2KF40	1 1	1 unit 1 unit	101 101	0.255 0.256
6	3	2	1	2	1 ³⁾	24 110	A A	3RH11 22-2KB40-0LAO 3RH11 22-2KF40-0LAO	1 1	1 unit 1 unit	101 101	0.284 0.285

1) It is not possible to mount an auxiliary switch block. A clearance of 10 mm is required for side-by-side mounting at ambient temperatures > 60 °C.

2) Version without series resistor.

3) One 4-pole auxiliary switch block according to EN 50005 can be mounted; no clearance required up to 70 °C.

3RT, 3RH, 3TB, 3TC, 3TH, 3TK Contactors for Special Applications

Contactors with Extended Tolerance 0.7 ... 1.25 x U_s, for Railway Applications

3TH4 contactor relays

Overview

3TH4 contactor relays

EN 60947-4-1.

For requirements according to IEC 60077-1 and IEC 60077-2.

The contactors are finger-safe according to EN 50274. Terminal covers may have to be fitted onto the connecting bars, depending on the configuration with other devices.

Application

For operation in plants which are subject both to considerable variations in the control voltage and to high ambient temperatures, e.g. in railway applications.

Selection and ordering data

With screw terminals

For screw and snap-on mounting onto 35 mm standard mounting rail

Solenoid fitted with varistor



3TH4

Contacts	Rated operational current I_e /AC-15/AC-14	Contacts ¹⁾	Rated control supply voltage U_s	DT	Order No.	Price per PU	PU (UNIT, SET, M)	PS*	PG	Weight per PU approx.	
	230 V 400 V 500 V 690 V	Ident. No. acc. to EN 50011									
Number	A A A A	NO NC V								kg	
3TH42 contactor relays · DC operation · DC solenoid system											
8	10	6 4 2	44 E	4 4	24 DC 110 DC	B B	3TH42 44-0LB4 3TH42 44-0LF4	1 1	1 unit 1 unit	101 101	0.674 0.661
			53 E	5 3	24 DC 110 DC	C C	3TH42 53-0LB4 3TH42 53-0LF4	1 1	1 unit 1 unit	101 101	0.669 0.660
			62 E	6 2	24 DC 110 DC	B B	3TH42 62-0LB4 3TH42 62-0LF4	1 1	1 unit 1 unit	101 101	0.667 0.663

For accessories, see page 3/139.

1) Contacts not extendable.

3RT, 3RH, 3TB, 3TC, 3TH, 3TK Contactors for Special Applications

Contactors with Extended Tolerance 0.7 ... 1.25 x U_s , for Railway Applications

3RT10 motor contactors, 5.5 ... 45 kW

Overview

DC operation

IEC 60947-4-1, EN 60947-4-1 (VDE 0660, Part 102), for requirements according to IEC 60077-1 and IEC 60077-2.

The contactors are finger-safe according to EN 50274 (exception: series resistors S0 to S3). The contactors are available with both Cage Clamp and screw terminals. The size S00 contactors have Cage Clamp terminals for all connections. The auxiliary conductor and coil terminals of sizes S0 to S3 are all Cage Clamp terminals.

Ambient temperature

The permissible ambient temperature for operation of the contactors (across the full coil operating range) is -40 °C to +70 °C.

Uninterrupted duty at temperatures > +55 °C reduces the mechanical endurance, the current-carrying capacity of the conducting paths and the operating frequency.

Dimensions

Attaching resistors increases the width of contactor sizes S0 to S3 (see Dimensional Drawings).

Application

For operation in installations which are subject both to considerable variations in the control voltage and to high ambient temperatures, e.g. railway applications under extreme climatic conditions, rolling mills, etc.

Control and auxiliary circuits

The coils of the contactors have an extended tolerance from 0.7 to 1.25 x U_s and are fitted as standard with varistors to provide protection against voltage surges. The opening delay is consequently 2 to 5 ms longer than for standard contactors.

3RT10 ...-0LA0

The DC solenoid systems of the contactors are modified (to hold-in coil) by means of a series resistor.

The size S00 contactors are supplied prewired with a plug-on module containing the series resistor. The varistor is integrated. A 4-pole auxiliary switch block (according to EN 50005) can be fitted additionally.

The size S0 to S3 contactors are equipped on the front with an auxiliary switch block with 2 NO + 2 NC contacts. The separate series resistor, which is attached laterally next to the contactor on the 35 mm standard mounting rail, is fitted with connecting leads for mounting the contactors. A circuit diagram showing the terminals is stuck onto each contactor. One NC of the auxiliary contacts is required for the series resistor function. The selection and ordering data shows the number of additional, unassigned auxiliary contacts. It is only possible to extend the number of auxiliary contacts with size S00.

Mounting

At ambient temperatures up to 70 °C, the size S00 contactors and contactor relays are allowed to be mounted side by side. The resistor module of the size S0 to S3 contactors must be mounted to the left of the contactor owing to the prefabricated connecting leads.

**3RT10 17-2K.4.,
3RT10 2.-3K.40**

These contactors have an extended tolerance from 0.7 to 1.25 x U_s ; the coils are fitted with varistors as standard. An additional series resistor is not required.

Please note:

- Size S00: it is not possible to mount an auxiliary switch block.
- Size S0: up to two single-pole auxiliary switch blocks can be mounted.

At ambient temperatures > 60 °C ≤ 70 °C, a clearance of 10 mm is required when they are mounted side by side.

3RT10 contactors with contactor control unit, extended tolerance

Control and auxiliary circuits

The coils of the contactors have an extended tolerance from 0.7 to 1.25 x U_s and are fitted as standard with varistors to provide protection against voltage surges. The opening delay is consequently 2 ms to 5 ms longer than for standard contactors.

3RT10 ...-X.40-0LA2

The contactors are energized using series-connected control electronics, ensuring the coil operating range of 0.7 to 1.25 x U_s at an ambient temperature of 70 °C. They are supplied as complete self-contained units with a built-on contactor control unit. A varistor is integrated for damping opening surges in the coil.

The possibility of mounting auxiliary switches is the same as that for equivalent standard contactors.

Mounting

At ambient temperatures up to 70 °C, sizes S0 to S3 of these contactor versions are allowed to be mounted side by side.

Ambient temperature

The permissible ambient temperature for operation of the contactors (across the full operating range of the coils) is -40 °C to +70 °C.

Uninterrupted duty at temperatures > +55 °C reduces the mechanical endurance, the current-carrying capacity of the conducting paths and the operating frequency.

Dimensions

Because of the built-on contactor control unit, the height of the size S0 to S3 contactors increases by up to 34 mm (see Dimensional Drawings).

3RT, 3RH, 3TB, 3TC, 3TH, 3TK Contactors for Special Applications

Contactors with Extended Tolerance 0.7 ... 1.25 x U_s, for Railway Applications

3RT10 motor contactors, 5.5 ... 45 kW

Selection and ordering data

DC operation · DC solenoid system

Cage Clamp terminals

For screw and snap-on mounting onto standard mounting rail

Solenoid fitted with varistor



3RT10 17-2K.4.-0LA0



3RT10 2.-3K.40



3RT10 3.-3K.44-0LA0

Rated data AC-2 and AC-3 T _u : 70 °C	Auxiliary contacts	Rated control supply voltage U _s	DT	Cage Clamp terminals	PU (UNIT, SET, M)	PS*	PG	Weight per PU approx.
Operational current I _e at 400 V	Rating of induction motors at 230 V 400 V 500 V 690 V	Version		Order No.	Price per PU			kg
A	kW kW kW kW	NO NC	V DC					

3RT10 contactors for switching motors

Size S00

Cage Clamp terminals for all connections

12	3	5.5	5.5	5.5	1 ¹⁾	--	24 ³⁾ 110 ³⁾	▶	3RT10 17-2KB41	1	1 unit	101	0.256
								B	3RT10 17-2KF41	1	1 unit	101	0.256
12	3	5.5	5.5	5.5	--	1 ¹⁾	24 ³⁾ 110 ³⁾	▶	3RT10 17-2KB42	1	1 unit	101	0.256
								B	3RT10 17-2KF42	1	1 unit	101	0.255
12	3	5.5	5.5	5.5	--	1 ²⁾	24 110	A	3RT10 17-2KB42-0LA0	1	1 unit	101	0.283
								B	3RT10 17-2KF42-0LA0	1	1 unit	101	0.285

Size S0

Cage Clamp terminals for coil connections and auxiliary contacts

17	4	7.5	10	11	--	-- ⁴⁾	24 ³⁾ 110 ³⁾	▶	3RT10 25-3KB40	1	1 unit	101	0.580
								B	3RT10 25-3KF40	1	1 unit	101	0.574
25	5.5	11	11	11	--	-- ⁴⁾	24 ³⁾ 110 ³⁾	▶	3RT10 26-3KB40	1	1 unit	101	0.581
								B	3RT10 26-3KF40	1	1 unit	101	0.575
17	4	7.5	10	11	2	2 ⁵⁾	24 110	B	3RT10 25-3KB44-0LA0	1	1 unit	101	0.760
								B	3RT10 25-3KF44-0LA0	1	1 unit	101	0.745
25	5.5	11	11	11	2	2 ⁵⁾	24 110	B	3RT10 26-3KB44-0LA0	1	1 unit	101	0.758
								B	3RT10 26-3KF44-0LA0	1	1 unit	101	0.742

Size S2

Cage Clamp terminals for coil connections and auxiliary contacts

32	7.5	15	18.5	18.5	2	2 ⁵⁾	24 110	B	3RT10 34-3KB44-0LA0	1	1 unit	101	1.630
								B	3RT10 34-3KF44-0LA0	1	1 unit	101	1.664
40	11	18.5	22	22	2	2 ⁵⁾	24 110	B	3RT10 35-3KB44-0LA0	1	1 unit	101	1.648
								B	3RT10 35-3KF44-0LA0	1	1 unit	101	1.656
50	15	22	30	22	2	2 ⁵⁾	24 110	B	3RT10 36-3KB44-0LA0	1	1 unit	101	1.647
								B	3RT10 36-3KF44-0LA0	1	1 unit	101	1.669

Size S3

Cage Clamp terminals for coil connections and auxiliary contacts

65	18.5	30	37	43	2	2 ⁵⁾	24 110	B	3RT10 44-3KB44-0LA0	1	1 unit	101	3.070
								B	3RT10 44-3KF44-0LA0	1	1 unit	101	3.028
80	22	37	45	55	2	2 ⁵⁾	24 110	B	3RT10 45-3KB44-0LA0	1	1 unit	101	3.085
								B	3RT10 45-3KF44-0LA0	1	1 unit	101	2.670
95	22	45	55	55	2	2 ⁵⁾	24 110	B	3RT10 46-3KB44-0LA0	1	1 unit	101	3.090
								B	3RT10 46-3KF44-0LA0	1	1 unit	101	3.042

For spare parts, see page 3/127.

- 1) It is not possible to mount an auxiliary switch block. A clearance of 10 mm is required for side-by-side mounting at ambient temperatures >60 °C.
- 2) One 4-pole auxiliary switch block according to EN 50005 can be mounted; no clearance required up to 70 °C.
- 3) Version without series resistor.
- 4) Up to two single-pole auxiliary switch blocks can be mounted. A clearance of 10 mm is required for side-by-side mounting at ambient temperatures >60 °C.
- 5) The number of auxiliary contacts cannot be increased; no clearance required up to 70 °C.

* You can order this quantity or a multiple thereof.