

XPT IGBT

Copack

$I_{C25} = 28 \text{ A}$
 $V_{CES} = 1200 \text{ V}$
 $V_{CE(sat)typ} = 1.8 \text{ V}$

Part number

IXA17IF1200HJ

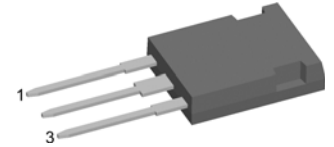
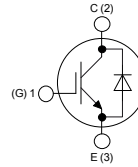

Features / Advantages:

- Easy paralleling due to the positive temperature coefficient of the on-state voltage
- Rugged XPT design (Xtreme light Punch Through) results in:
 - short circuit rated for 10 μsec .
 - very low gate charge
 - low EMI
 - square RBSOA @ 3x I_c
- Thin wafer technology combined with the XPT design results in a competitive low $V_{CE(sat)}$
- SONIC™ diode
 - fast and soft reverse recovery
 - low operating forward voltage

Applications:

- AC motor drives
- Solar inverter
- Medical equipment
- Uninterruptible power supply
- Air-conditioning systems
- Welding equipment
- Switched-mode and resonant-mode power supplies
- Inductive heating, cookers

Package:

- Housing: ISOPLUS247
- Industry standard outline
- DCB isolated backside
- Isolation Voltage 3000 V
- Epoxy meets UL 94V-0
- RoHS compliant

IGBT

Symbol	Definition	Conditions	Ratings			Unit
			min.	typ.	max.	
V_{CES}	Collector emitter voltage	$V_{GE} = 0 \text{ V}$			1200	V
V_{GES}	Maximum DC gate voltage				± 20	V
I_{C25}	Collector current				28	A
I_{C90}					18	A
P_{tot}	Total power dissipation				100	W
I_{CES}	Collector emitter leakage current	$V_{CE} = V_{CES} ; V_{GE} = 0 \text{ V}$			0.1	mA
				0.1		mA
I_{GES}	Gate emitter leakage current	$V_{CE} = 0 \text{ V}; V_{GE} = \pm 20 \text{ V}$			500	nA
$V_{CE(sat)}$	Collector emitter saturation voltage	$I_C = 16 \text{ A}; V_{GE} = 15 \text{ V}$		1.8	2.1	V
				2.1		V
$V_{GE(th)}$	Gate emitter threshold voltage	$I_C = 0.6 \text{ mA}; V_{GE} = V_{CE}$	5.4	6	6.5	V
Q_{Gon}	Total gate charge	$V_{CE} = 600 \text{ V}; V_{GE} = 15 \text{ V}; I_C = 15 \text{ A}$		47		nC
$t_{d(on)}$	Turn-on delay time			70		ns
t_r	Current rise time			40		ns
$t_{d(off)}$	Turn-off delay time	Inductive load		250		ns
t_f	Current fall time	$V_{CE} = 600 \text{ V}; I_C = 15 \text{ A}$		100		ns
E_{on}	Turn-on energy per pulse	$V_{GE} = \pm 15 \text{ V}; R_G = 56 \Omega$	$T_{VJ} = 125^\circ\text{C}$	1.55		mJ
E_{off}	Turn-off energy per pulse			1.7		mJ
RBSOA	Reverse bias safe operation area	$V_{GE} = 15 \text{ V}; R_G = 56 \Omega$ $V_{CEK} = 1200 \text{ V}$	$T_{VJ} = 125^\circ\text{C}$		45	A
SCSOA	Short circuit safe operation area					
t_{sc}	Short circuit duration	$V_{CE} = 900 \text{ V}; V_{GE} = \pm 15 \text{ V}$	$T_{VJ} = 125^\circ\text{C}$		10	μs
I_{sc}	Short circuit current	$R_G = 56 \Omega$; non-repetitive			60	A
R_{thJC}	Thermal resistance junction to case				1.26	K/W

Diode

Symbol	Definition	Conditions	Ratings			Unit
			min.	typ.	max.	
I_{F25}	Forward current	$T_C = 25^\circ\text{C}$			32	A
I_{F90}		$T_C = 90^\circ\text{C}$			19	A
V_F	Forward voltage	$I_F = 20\text{ A}$	$T_{VJ} = 25^\circ\text{C}$	1.95	2.2	V
			$T_{VJ} = 125^\circ\text{C}$	1.95		V
Q_{rr}	Reverse recovery charge	$V_R = 600\text{ V}$ $di_F/dt = - 400\text{ A}/\mu\text{s};$ $I_F = 20\text{ A}$	$T_{VJ} = 125^\circ\text{C}$	3		μC
I_{RM}	Maximum reverse recovery current			20		A
t_{rr}	Reverse recovery time			350		ns
$E_{rec(off)}$	Reverse recovery losses at turn-off			0.7		mJ
R_{thJC}	Thermal resistance junction to case				1.5	K/W

Equivalent Circuits for Simulation

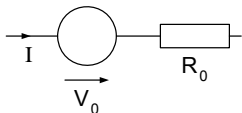

Symbol	Definition		Ratings			Unit
			min.	typ.	max.	
V_0	IGBT	$T_{VJ} = 150^\circ\text{C}$			1.1	V
R_0					86	m Ω
V_0	Diode	$T_{VJ} = 150^\circ\text{C}$			1.25	V
R_0					42.5	m Ω

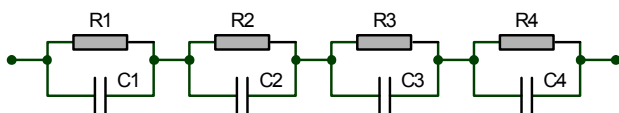

$$Z_{th}(t) = \sum_{i=1}^n \left[R_i \cdot \left(1 - \exp\left(-\frac{t}{\tau_i}\right) \right) \right]$$

$$\tau_i = R_i \cdot C_i$$

	IGBT	Diode
R_1	0.252	0.46
R_2	0.209	0.29
R_3	0.541	0.42
R_4	0.258	0.33
τ_1	0.0015	0.0025
τ_2	0.03	0.03
τ_3	0.03	0.03
τ_4	0.08	0.08

Package ISOPLUS247

Symbol	Definition	Conditions	Ratings			Unit
			min.	typ.	max.	
T_{VJ}	Virtual junction temperature		-55		150	°C
T_{stg}	Storage temperature		-55		150	°C
R_{thCH}	Thermal resistance case to heatsink			0.25		K/W
Weight				6		g
F_C	Mounting force with clip		20		120	N
V_{ISOL}	Isolation voltage	t = 1 second	3600			V
		t = 1 minute	3000			V
d_s	Creepage distance on surface					mm
d_A	Striking distance through air					mm

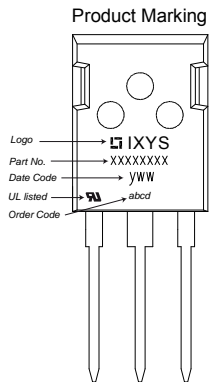
Part number

I = IGBT
 X = XPT IGBT
 A = Gen 1 / std
 17 = Current Rating [A]
 IF = Copack
 1200 = Reverse Voltage [V]
 HJ = ISOPLUS247 (3)

Ordering	Part Name	Marking on Product	Delivering Mode	Base Qty	Code Key
Standard	IXA 17 IF 1200 HJ	IXA17IF1200HJ	Tube	30	507522

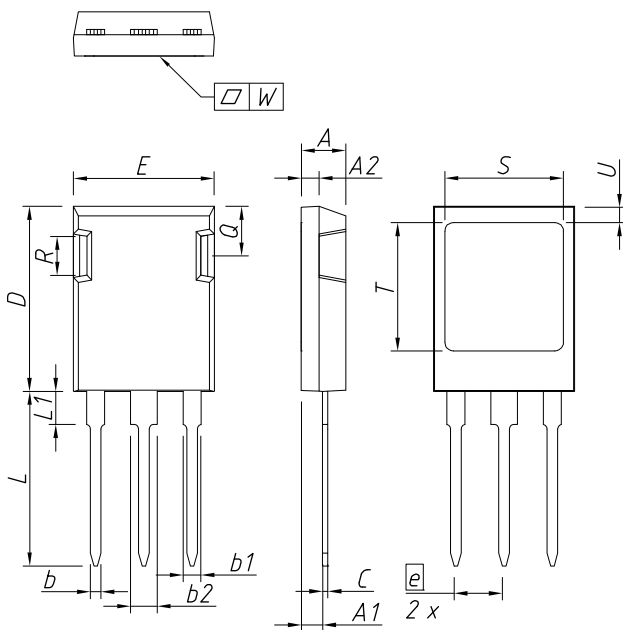

DIM.	MILLIMETER		INCHES	
	MIN	MAX	MIN	MAX
A	4,83	5,21	0,190	0,205
A1	2,29	2,54	0,090	0,100
A2	1,91	2,16	0,075	0,085
b	1,14	1,40	0,045	0,055
b1	1,91	2,15	0,075	0,085
b2	2,92	3,20	0,115	0,126
C	0,61	0,83	0,024	0,033
D	20,80	21,34	0,819	0,840
E	15,75	16,13	0,620	0,635
e	5,45 BSC		0,215 BSC	
L	19,81	20,60	0,780	0,811
L1	3,81	4,38	0,150	0,172
Q	5,59	6,20	0,220	0,244
R	4,32	4,85	0,170	0,191
S	13,21	13,72	0,520	0,540
T	15,75	16,26	0,620	0,640
U	1,65	2,03	0,065	0,080
W	-	0,10	-	0,004

Die konvexe Form des Substrates ist typ. < 0.04 mm über der Kunststoffoberfläche der Bauteilunterseite
 The convex bow of substrate is typ. < 0.04 mm over plastic surface level of device bottom side

Die Gehäuseabmessungen entsprechen dem Typ TO-247 AD gemäß JEDEC außer Schraubloch und L_{max}.
 This drawing will meet all dimensions requirement of JEDEC outline TO-247 AD except screw hole and except L_{max}.

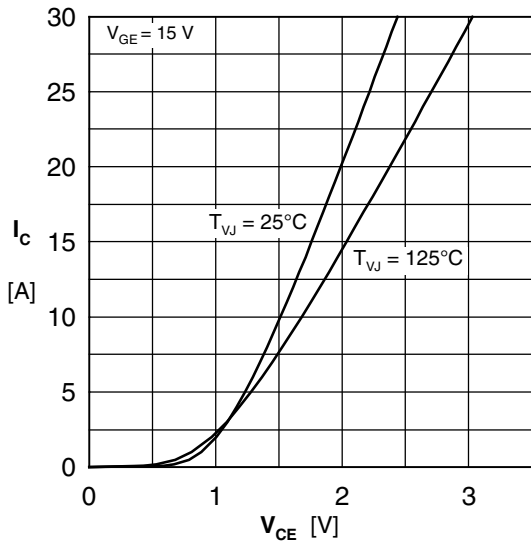

Fig. 1 Typ. output characteristics

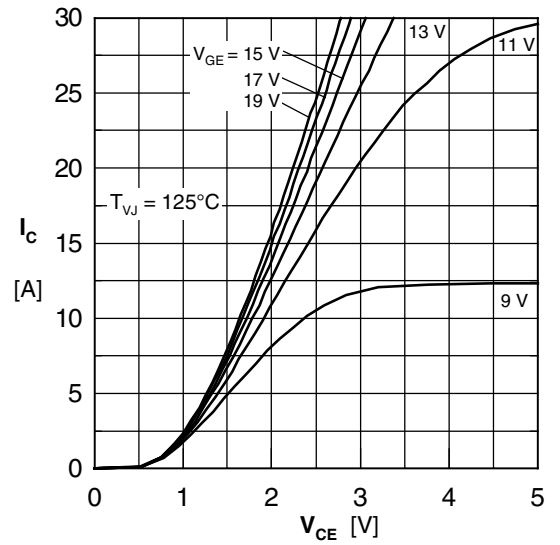

Fig. 2 Typ. output characteristics

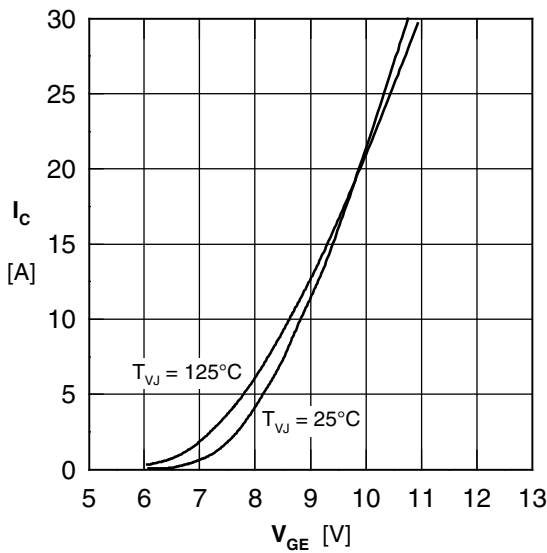

Fig. 3 Typ. transfer characteristics

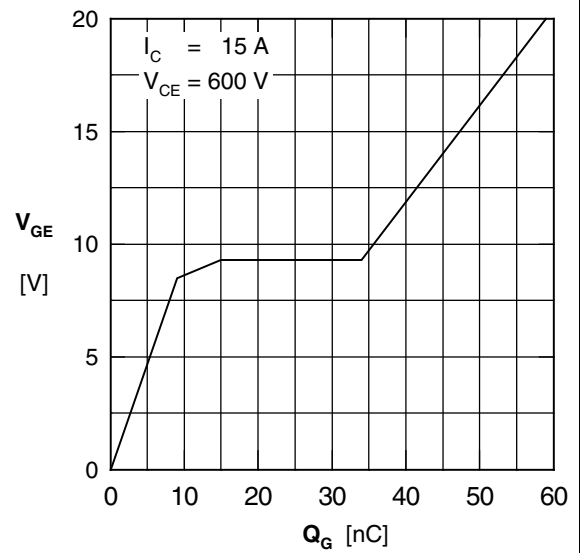

Fig. 4 Typ. turn-on gate charge

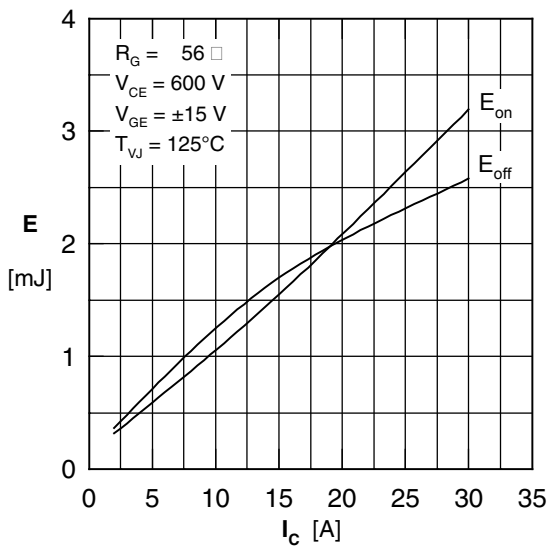

Fig. 5 Typ. switching energy vs. collector current

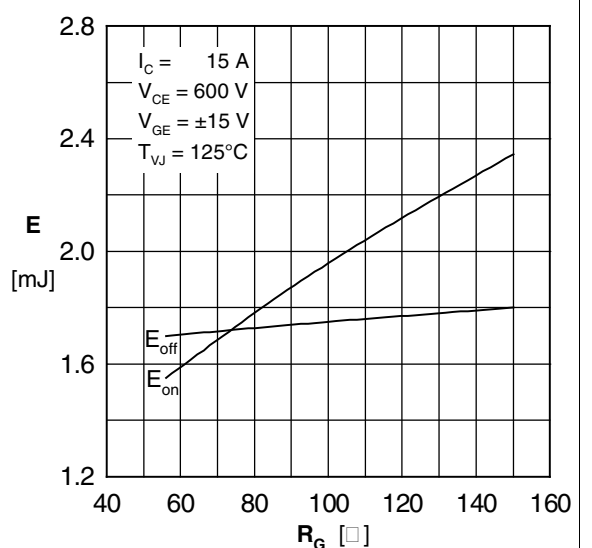

Fig. 6 Typ. switching energy vs. gate resistance

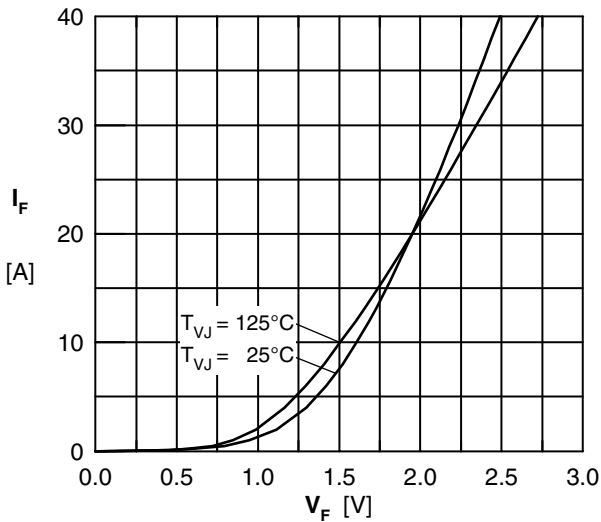

Fig. 7 Typ. Forward current versus V_F

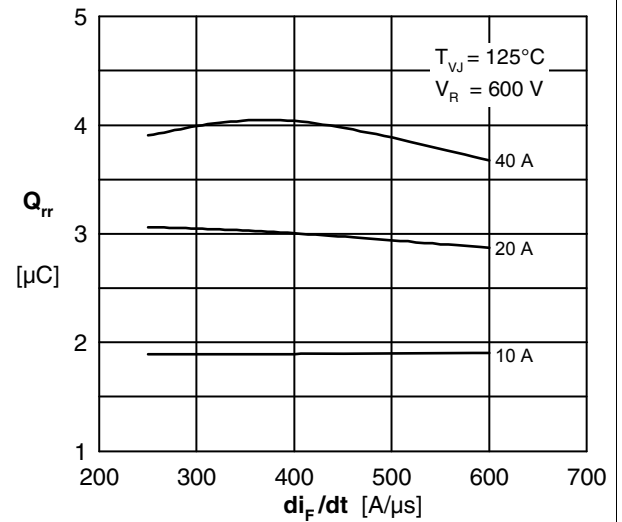

Fig. 8 Typ. reverse recov.charge Q_{rr} vs. di/dt

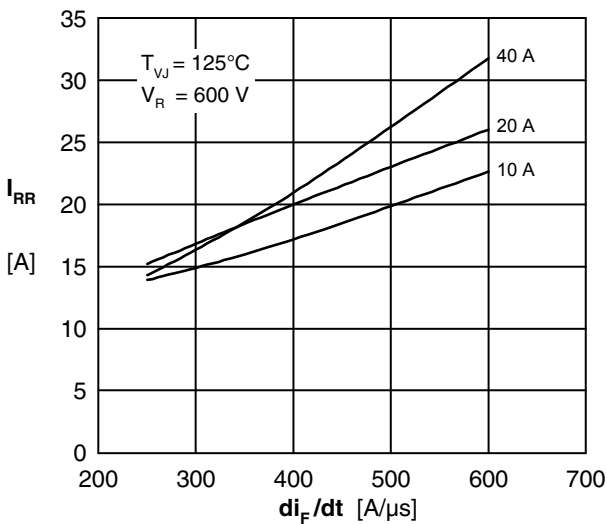

Fig. 9 Typ. peak reverse current I_{RM} vs. di/dt

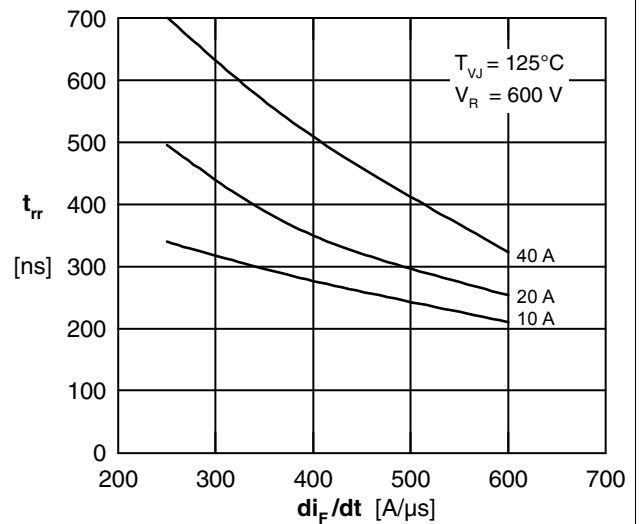

Fig. 10 Typ. recovery time t_{rr} versus di/dt

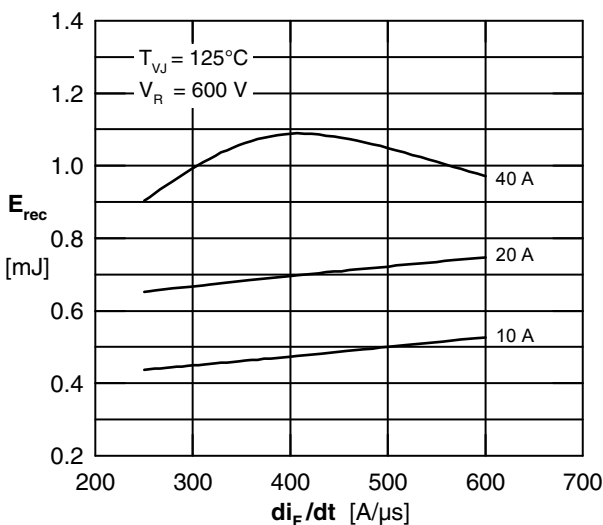

Fig. 11 Typ. recovery energy E_{rec} versus di/dt

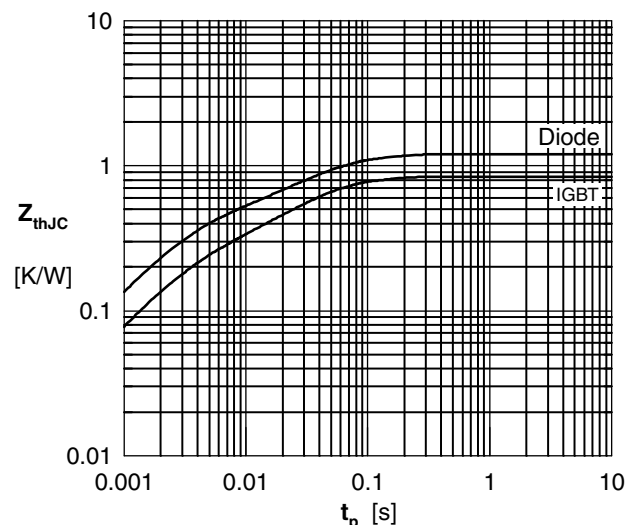

Fig. 12 Typ. transient thermal impedance