

DWG. NO.
SD-35452-001

SIMILAR ITEM

PROJECT NO.

DO NOT SCALE DRAWING
DIMENSION IN METRIC

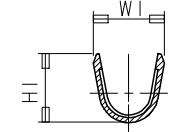
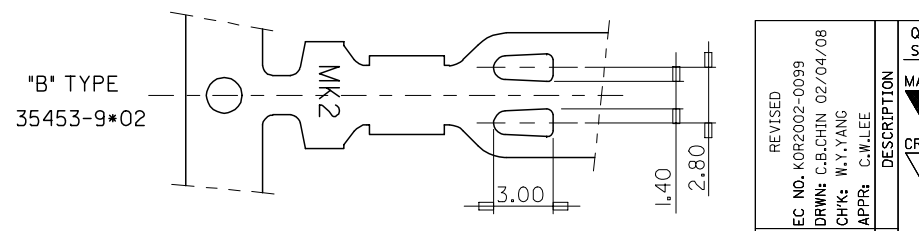
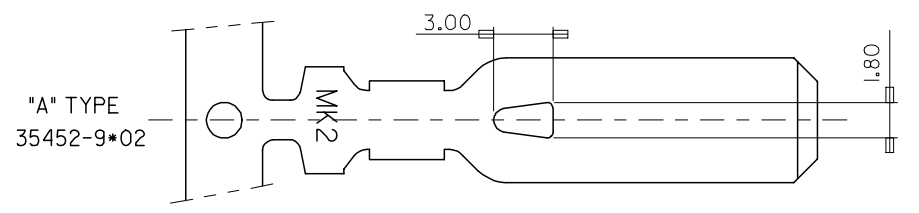
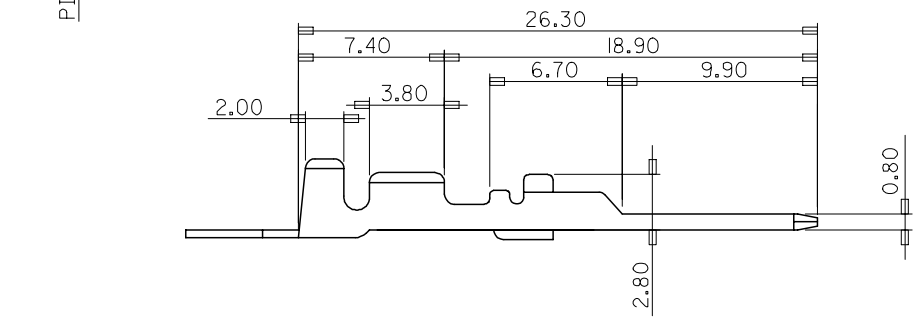
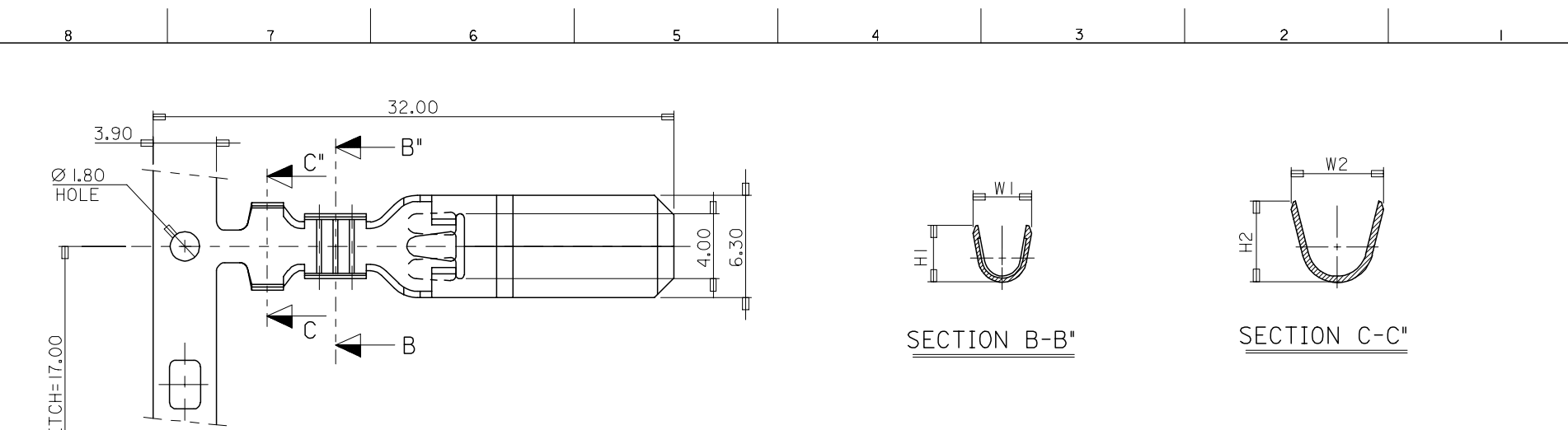

SECTION B-B'

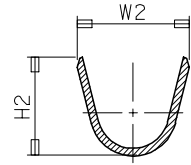

SECTION C-C'

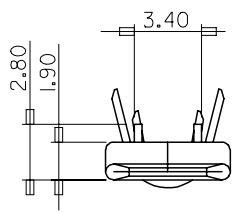

NOTES

- 1. MATERIAL: BRASS
- 2. FINISHES: PRE-TIN PLATED

ENG.NO	MATERIAL NO.	W1	H1	W2	H2
3545*-9702	3545*9702	2.8	2.8	3.8	3.8
3545*-9802	3545*9802	3.5	3.5	5.6	5.2
3545*-9902	3545*9902	5.0	4.8	6.3	6.3

* : 2 AND 3

REVISED EC NO. KOR2002-0099 DRWN: C.B.CHIN 02/04/08 CHK: W.Y.YANG APPR: C.W.LEE	QUALITY SYMBOLS MAJOR = 0 CRITICAL = 0	GENERAL TOLERANCES: (UNLESS SPECIFIED)		SCALE 4:1	DESIGN UNITS <input checked="" type="checkbox"/> mm <input type="checkbox"/> INCH	THIRD ANGLE PROJECTION <input checked="" type="checkbox"/> mm <input type="checkbox"/> INCH	DIMENSIONS: <input type="checkbox"/> mm <input type="checkbox"/> INCH <input checked="" type="checkbox"/> mm ONLY		SHT	REV	
		4 PLACES ±0. INCH	3 PLACES ±0. INCH	2 PLACES ±0.30 INCH	1 PLACE ±0.30 INCH	DRAWN BY & DATE W.Y.YANG 97/11/04		CHECKED BY & DATE B.K.CHOI 97/11/04		APPROVED BY & DATE C.W.LEE 97/11/04	
DESCRIPTION		ANGULAR: ± 1.0 °		CAD FILENAME S35452AA.DGN		MATERIAL NO. SEE TABLE		DRAWING NO. SD-35452-001		SHEET NO. 1/1	
A		DRAFT WHERE APPLICABLE MUST REMAIN WITHIN DIMENSIONS		THIS DRAWING CONTAINS INFORMATION THAT IS PROPRIETARY TO MOLEX INCORPORATED AND SHOULD NOT BE USED WITHOUT WRITTEN PERMISSION.						SIZE B	

TITLE:
.250 HEAVY TAB-(A),(B)

MOLEX MOLEX INCORPORATED