

### Compact and Intelligent Temperature Controllers

- Depth of only 78 mm.
- Various temperature inputs: thermocouple, platinum resistance thermometer, non-contact temperature sensor, and analog inputs.
- Auto-tuning and self-tuning available. Auto-tuning is possible even while self-tuning is being executed.
- Heating or heating/cooling control is available.
- Event input allows multiple SP selection and run/stop function.
- Water-resistant construction (NEMA4X: equivalent to IP66).
- Conforms to UL, CSA, and IEC safety standards as well as CE marking.



48(W) x 96(H) x 78(D) mm

### Ordering Information

#### ■ E5EN Standard Models

Size	Power supply voltage	No. of alarm points	Output	Heater burnout alarm	Thermocouple model	Platinum resistance thermometer model
1/8 DIN 48(W) x 96(H) x 78(D) mm	100 to 240 VAC	3	Relay	No	E5EN-R3MTC-500	E5EN-R3MP-500
				Yes	E5EN-R3HMTC-500	E5EN-R3HMP-500
			Voltage output (for driving SSR)	No	E5EN-Q3MTC-500	E5EN-Q3MP-500
				Yes	E5EN-Q3HMTC-500	E5EN-Q3HMP-500
			Current	No	E5EN-C3MTC-500	E5EN-C3MP-500
				Yes	E5EN-C3HMTC-500	E5EN-C3HMP-500
	24 VAC/VDC	3	Relay	No	E5EN-R3MTC-500	E5EN-R3MP-500
				Yes	E5EN-R3HMTC-500	E5EN-R3HMP-500
			Voltage output (for driving SSR)	No	E5EN-Q3MTC-500	E5EN-Q3MP-500
				Yes	E5EN-Q3HMTC-500	E5EN-Q3HMP-500
			Current	No	E5EN-C3MTC-500	E5EN-C3MP-500
				Yes	E5EN-C3HMTC-500	E5EN-C3HMP-500

- Note:**
1. A Current Transformer (CT) is not provided with the Unit. Be sure to order one when ordering the E5EN.
  2. When the heating and cooling function is used, the number of alarm outputs will be reduced to 2.
  3. When the heating and cooling function or the heater burnout alarm is used, one of the alarm outputs will be disabled for each function used.
  4. Specify the power supply specifications when ordering.

#### ■ E5EN Option Units

The E5EN provides communication or event input functionality when mounted with one of the following Option Units.

Name	Model	Function
Communication Unit	E53-AK01	RS-232C communication
	E53-AK03	RS-485 communication
Event Input Unit	E53-AKB	Event input

#### ■ Current Transformer (Sold Separately)

Model	E54-CT1	E54-CT3
Hole diameter	5.8 dia.	12.0 dia.

#### ■ Terminal Cover (Sold Separately)

Model	E53-COV03
-------	-----------

■ Input Ranges

Platinum Resistance Thermometer Input/Thermocouple Input

Platinum resistance thermometer input				
Input type	Platinum resistance thermometer			
Name	Pt100		JPt100	
Temperature rangentlp	1800	1700	1600	1500
	1400	1300	1200	1100
	1000	900	800	700
	600	500	400	300
	200	100	0	-100
	-200			
Set value	0	1	2	3

Thermocouple input																	
Input type	Thermocouple										ES1A Non-contact Temperature Sensor				Analog input		
Name	K	J	T	E	L	U	N	R	S	B	K10 to 70°C	K60 to 120°C	K115 to 165°C	K160 to 260°C	0 to 50 mV		
Temperature rangentlp	1800	1700	1600	1500	1400	1300	1200	1100	1000	900	800	700	600	500	400		
	300	200	100	0	-100	-200	-200	-200	-200	-200	100	0	0	0	0		
Set value	0	1	2	3	4	5	6	7	8	9	10	11	12	13	14	15	16

Applicable standards by input type are as follows:

- K, J, T, E, N, R, S, B: JIS C1602-1995
- L: Fe-CuNi, DIN 43710-1985
- U: Cu-CuNi, DIN 43710-1985
- JPt100: JIS C1604-1989, JIS C1606-1989
- Pt100: JIS C1604-1997, IEC751

Shaded ranges indicate default settings.

# Specifications

## ■ Ratings

Supply voltage	100 to 240 VAC, 50/60 Hz	24 VAC, 50/60 Hz/24 VDC
Operating voltage range	85% to 110% of rated supply voltage	
Power consumption	9 VA	5 VA/4 W
Sensor input	Thermocouple: K, J, T, E, L, U, N, R, S, B Platinum resistance thermometer: Pt100, JPt100 Non-contact temperature sensor: K10 to 70°C, K60 to 120°C, K115 to 165°C, K160 to 260°C Voltage input: 0 to 50 mV	
Control output	Relay output	SPST-NO, 250 VAC, 5 A (resistive load), electrical life: 100,000 operations
	Voltage output	12 VDC (PNP), max. load current: 40 mA, with short-circuit protection circuit
	Current output	4 to 20 mA DC, load: 600 Ω max., resolution: approx. 2,600
Alarm output	SPST-NO, 250 VAC, 3 A (resistive load), electrical life: 100,000 operations	
Control method	2-PID or ON/OFF control	
Setting method	Digital setting using front panel keys	
Indication method	7-segment digital display and single-lighting indicator Character height: PV: 14.0 mm; SV: 9.5 mm	
Other functions	According to Controller model	
Ambient temperature	-10 to 55°C (with no condensation or icing)	
Ambient humidity	25% to 85%	
Storage temperature	-25 to 65°C (with no condensation or icing)	

## ■ Characteristics

Indication accuracy	Thermocouple: (±0.5% of indicated value or ±1°C, whichever greater) ±1 digit max. (see note ) Platinum resistance thermometer: (±0.5% of indicated value or ±1°C, whichever greater) ±1 digit max. Analog input: ±0.5% FS±1 digit max. CT input: ±5% FS±1 digit max.	
Hysteresis	0.1 to 999.9 EU (in units of 0.1 EU)	
Proportional band (P)	0.1 to 999.9 EU (in units of 0.1 EU)	
Integral time (I)	0 to 3999 s (in units of 1 s)	
Derivative time (D)	0 to 3999 s (in units of 1 s)	
Control period	1 to 99 s (in units of 1 s)	
Manual reset value	0.0% to 100.0% (in units of 0.1%)	
Alarm setting range	-1999 to 9999 (decimal point position depends on input type)	
Sampling period	500 ms	
Insulation resistance	20 MΩ min. (at 500 VDC)	
Dielectric strength	2000 VAC, 50 or 60 Hz for 1min (between different charging terminals)	
Vibration resistance	10 to 55 Hz, 10 m/s <sup>2</sup> for 2 hours each in X, Y and Z directions	
Shock resistance	300 m/s <sup>2</sup> , 3 times each in 3 axes, 6 directions (relay: 100 m/s <sup>2</sup> )	
Weight	Approx. 260 g	Mounting bracket: Approx. 100 g
Protective structure	Front panel: NEMA4X for indoor use (equivalent to IP66), rear case: IP20, terminals: IP00	
Memory protection	EEPROM (non-volatile memory) (number of writes: 100,000)	
EMC	Emission Enclosure: EN55011 Group 1 class A Emission AC Mains: EN55011 Group 1 class A Immunity ESD: EN61000-4-2: 4 kV contact discharge (level 2) 8 kV air discharge (level 3) Immunity RF-interference: ENV50140: 10 V/m (amplitude modulated, 80 MHz to 1 GHz) (level 3) 10 V/m (pulse modulated, 900 MHz) Immunity Conducted Disturbance: ENV50141: 10 V (0.15 to 80 MHz) (level 3) Immunity Burst: EN61000-4-4: 2 kV power-line (level 3) 2 kV I/O signal-line (level 4)	
Approved standards	UL3121-1, CSA22.2 No. 14, E.B.1402C Conforms to EN50081-2, EN50082-2, EN61010-1 (IEC61010-1) Conforms to VDE0106/part 100 (Finger Protection), when the terminal cover is mounted.	

**Note:** The indication of K thermocouples in the -200 to 1300°C range, and T and N thermocouples at a temperature of -100°C or less, and U and L thermocouples at any temperature is ±2°C±1 digit maximum. The indication of B thermocouples at a temperature of 400°C or less is unrestricted.

The indication of R and S thermocouples at a temperature of 200°C or less is ±3°C±1 digit maximum.

## ■ Communications Specifications

Transmission path connection	Multiple points
Communications method (see note 1)	RS-485 (two-wire, half duplex)/RS-232C
Synchronization method	Start-stop synchronization
Baud rate	1,200/2,400/4,800/9,600/19,200 bps
Transmission code	ASCII
Data bit length (see note 2)	7 or 8 bits
Stop bit length (see note 2)	1 or 2 bits
Error detection	Vertical parity (none, even, odd) Frame check sequence (FCS): with SYSMAC WAY Block check character (BCC): with CompoWay/F
Flow control	Not available
Interface (see note 1)	RS-485/RS-232C
Retry function	Not available
Communications buffer	40 bytes

**Note:** 1. RS-232C communications are only supported for the E5AN and E5EN models.

2. The baud rate, data bit length, stop bit length, or vertical parity can be individually set using the communications setting level.

## ■ Current Transformer (Sold Separately) Ratings

Dielectric strength	1,000 VAC (1 min)
Vibration resistance	50 Hz 98 m/s <sup>2</sup>
Weight	E54-CT1: Approx. 11.5 g E54-CT3: Approx. 50 g
Accessories (E54-CT3 only)	Armature (2) Plug (2)

## ■ Heater Burnout Alarm Specifications

Max. heater current	Single-phase AC: 50 A (see note 1)
Input current readout accuracy	±5%FS±1 digit max.
Heater burnout alarm setting range	0.0 to 50.0 A (0.1 A units) (see note 2)
Min. detection ON time	190 ms (see note 3)

**Note:** 1. When heater burnout is detected on a 3-phase heater, use the K2CU-F□□A-□GS (with gate input terminal).

2. When the set value is "00 A," the heater burnout alarm will always be OFF. When the set value is "50.0 A," the heater burnout alarm will always be ON.

3. When the control output ON time is less than 190 ms, heater burnout detection and heater current measurement will not be carried out.

# Nomenclature

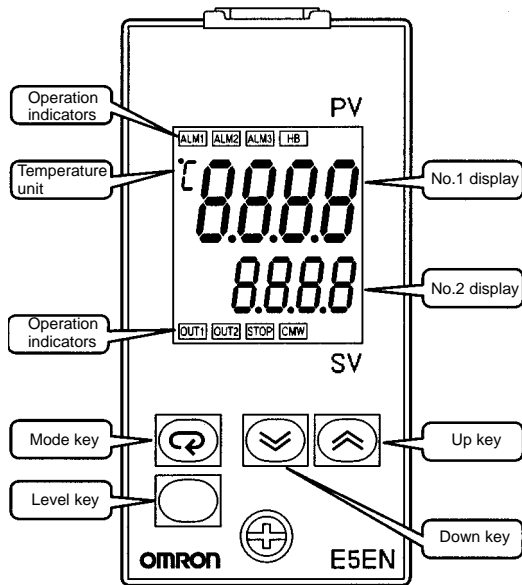

# Dimensions

**Note:** All units are in millimeters unless otherwise indicated.

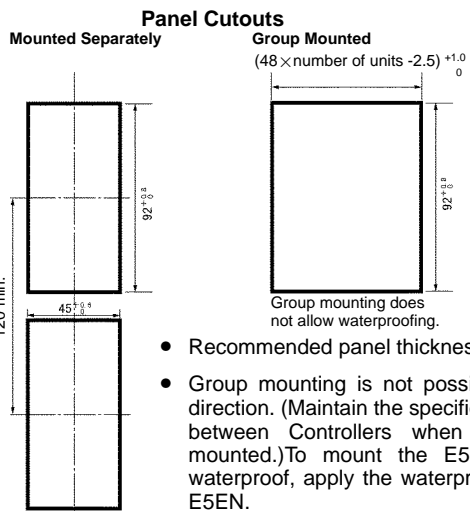
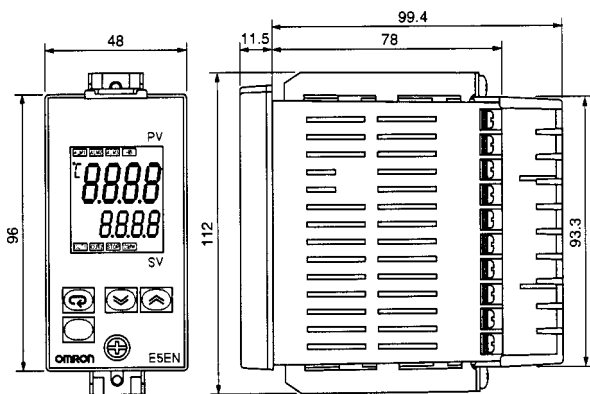

- Recommended panel thickness is 1 to 8 mm.
- Group mounting is not possible in the vertical direction. (Maintain the specified mounting space between Controllers when they are group mounted.) To mount the E5EN so that it is waterproof, apply the waterproof packing to the E5EN.
- To mount the E5EN so that it is waterproof, apply the waterproof packing to the E5EN.
- When two or more E5ENs are mounted, make sure that the surrounding temperature does not exceed the allowable operating temperature specified in the specifications.

**Current Transformer (Sold Separately)**

E54-CT1

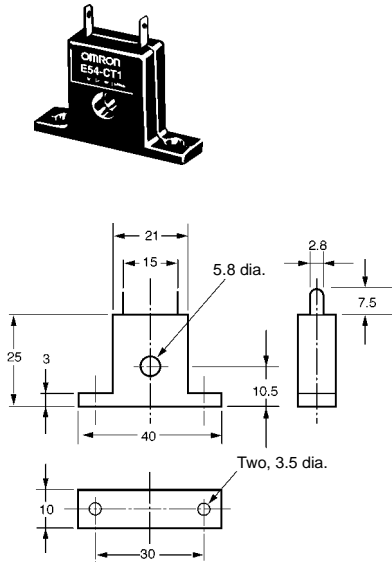

E54-CT3

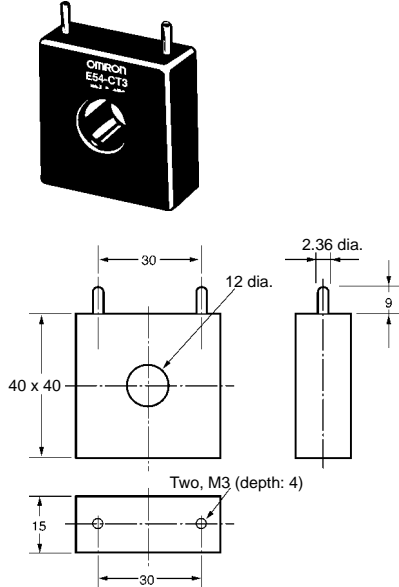

**Terminal Cover (Sold Separately)**

E53-COV03

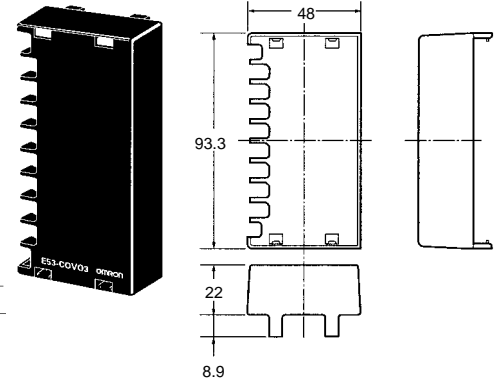

**Wiring Terminals**

- The voltage output (control output) is not electrically insulated from the internal circuits. When using a grounding thermocouple, do not connect the control output terminals to the ground. If the control output terminals are connected to the ground, errors will occur in the measured temperature values as a result of leakage current.
- Standard insulation is applied to the power supply I/O sections. If reinforced insulation is required, connect the input and output terminals to a device without any exposed current-carrying parts or to a device with standard insulation suitable for the maximum operating voltage of the power supply I/O section.

■ E5EN

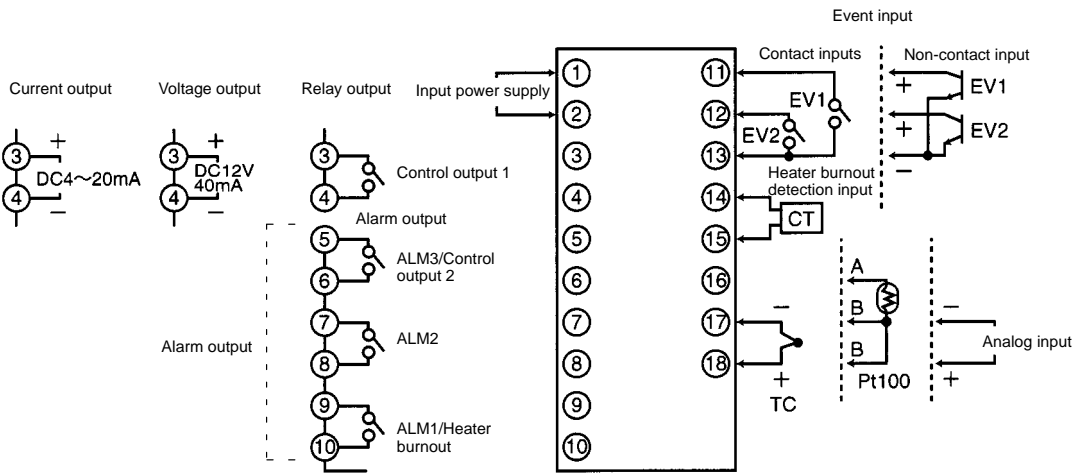

**Note:** Two input power supplies are available: 100 to 240 VAC or 24 VDC.

**ALL DIMENSIONS SHOWN ARE IN MILLIMETERS.**  
 To convert millimeters into inches, multiply by 0.03937. To convert grams into ounces, multiply by 0.03527.

# Nomenclature

## E5AN

### Operation Indicators

- ALM1 (alarm 1)  
Lights when alarm 1 output is ON.  
ALM2 (alarm 2)  
Lights when alarm 2 output is ON.  
ALM3 (alarm 3)  
Lights when alarm 3 output is ON.
- HB (heater burnout alarm display)  
Lights when a heater burnout is detected.  
The heater burnout alarm remains ON by setting the heater burnout latch. To reset, turn the power supply OFF and then ON or set the heater burnout alarm value to "0.0A."
- OUT1, OUT2 (control output 1, control output 2)  
Lights when control output 1 and/or control output 2 (cool) are ON.  
However, if control output 1 is current output, OUT1 will always be unlit.
- STOP (stop)  
Lights when control of the E5AN has been stopped.  
During control, this indicator lights when an event or the run/stop function has become stopped. Otherwise, this indicator is out.
- CMW (communications writing control)  
Lights when communications writing is enabled and is out when it is disabled.

### Temperature Unit

The temperature unit is displayed when the display unit parameter is set to a temperature. Indication is determined by the currently selected "temperature unit" parameter set value. When this parameter is set to "°C," "C" is displayed, and when set to "°F," "F" is displayed.

### No. 1 Display

Displays the process value or parameter type.

### No. 2 Display

Displays the set point, manipulated variable, or set value (setup) of the parameter.

### Up Key

Each press of this key increases values displayed on the No.2 display. Holding down this key continuously increases values.

### Down Key

Each press of this key decreases values displayed on the No.2 display. Holding down this key continuously decreases values.

### Mode Key

Press this key to select parameters within each level.

### Level + Mode Keys

This key combination sets the E5AN to the "protect level."

### Level Key

Press this key to select the setup level. The setup level is selected in order "operation level" ↔ "adjustment level," "initial setting level" ↔ "communications setting level."

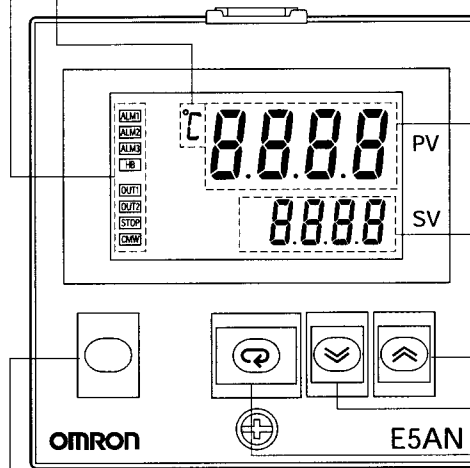

## E5EN

### Operation Indicators

- ALM1 (alarm 1)  
Lights when alarm 1 output is ON.  
ALM2 (alarm 2)  
Lights when alarm 2 output is ON.  
ALM3 (alarm 3)  
Lights when alarm 3 output is ON.
- HB (heater burnout alarm display)  
Lights when a heater burnout is detected.  
The heater burnout alarm remains ON by setting the heater burnout latch. To reset, turn the power supply OFF and then ON or set the heater burnout alarm value to "0.0A."
- OUT1, OUT2 (control output 1, control output 2)  
Lights when control output 1 and/or control output 2 (cool) are ON.  
However, if control output 1 is current output, OUT1 will always be unlit.
- STOP (stop)  
Lights when control of the E5EN has been stopped.  
During control, this indicator lights when an event or the run/stop function has become stopped. Otherwise, this indicator is out.
- CMW (communications writing control)  
Lights when communications writing is enabled and is out when it is disabled.

### Temperature Unit

The temperature unit is displayed when the display unit parameter is set to a temperature. Indication is determined by the currently selected "temperature unit" parameter set value. When this parameter is set to "°C," "C" is displayed, and when set to "°F," "F" is displayed.

### No. 1 Display

Displays the process value or parameter type.

### No. 2 Display

Displays the set point, manipulated variable, or set value (setup) of the parameter.

### Up Key

Each press of this key increases values displayed on the No.2 display. Holding down this key continuously increases values.

### Down Key

Each press of this key decreases values displayed on the No.2 display. Holding down this key continuously decreases values.

### Level Key

Press this key to select the setup level. The setup level is selected in order "operation level" ↔ "adjustment level," "initial setting level" ↔ "communications setting level."

### Level + Mode Keys

This key combination sets the E5EN to the "protect level."

### Mode Key

Press this key to select parameters within each level.

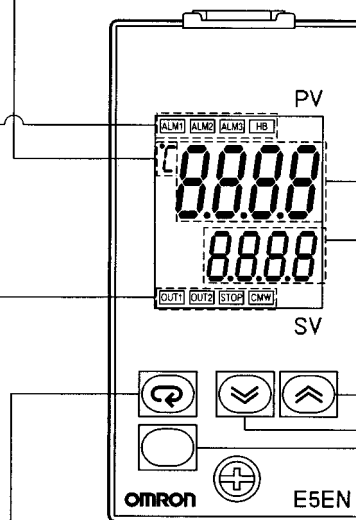

**E5CN**

**Operation Indicators**

1. AL1 (alarm 1)  
Lights when alarm 1 output is ON.  
AL2 (alarm 2)  
Lights when alarm 2 output is ON.
2. HB (heater burnout alarm display)  
Lights when a heater burnout is detected.  
The heater burnout alarm remains ON by setting the heater burnout latch. To reset, turn the power supply OFF and then ON or set the heater burnout alarm value to "0.0A."
3. OT1, OT2 (control output 1, control output 2)  
Lights when control output 1 and/or control output 2 (cool) are ON. However, if control output 1 is current output, OT1 will always be unlit.
4. STP (stop)  
Lights when control of the E5CN has been stopped.  
During control, this indicator lights when an event or the run/stop function has become stopped. Otherwise, this indicator is out.
5. CMW (communications writing control)  
Lights when communications writing is enabled and is out when it is disabled.

**Temperature Unit**

The temperature unit is displayed when the display unit parameter is set to a temperature. Indication is determined by the currently selected "temperature unit" parameter set value. When this parameter is set to "°C," "°C" is displayed, and when set to "°F," "°F" is displayed.

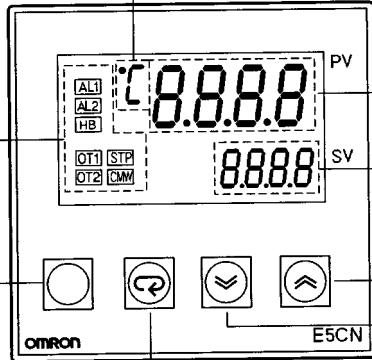

**No. 1 Display**

Displays the process value or parameter type.

**No. 2 Display**

Displays the set point, manipulated variable, or set value (setup) of the parameter.

**Up Key**

Each press of this key increases values displayed on the No.2 display. Holding down this key continuously increases values.

**Down Key**

Each press of this key decreases values displayed on the No.2 display. Holding down this key continuously decreases values.

**Mode Key**

Press this key to select parameters within each level.

**Level + Mode Keys**

This key combination sets the E5CN to the "protect level."

**Level Key**

Press this key to select the setup level. The setup level is selected in order "operation level" ↔ "adjustment level," "initial setting level" ↔ "communications setting level."

**E5GN**

**Operation Indicators**

1. AL (alarm)  
Lights when alarm output is ON.
2. CMW (communications writing control)  
Lights when communications writing is enabled and is out when it is disabled.
3. STP (stop)  
Lights when control of the E5GN has been stopped.  
During control, this indicator lights when an event or the run/stop function has been stopped. Otherwise, this indicator is out.
4. OUT (control output)  
Lights when control output is ON.

**Temperature Unit**

The temperature unit is displayed when the display unit parameter is set to a temperature. Indication is determined by the currently selected "temperature unit" parameter set value. When this parameter is set to "°C," "°C" is displayed, and when set to "°F," "°F" is displayed.

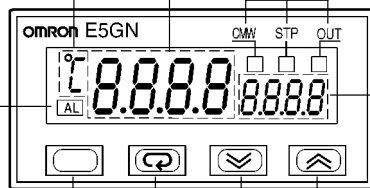

**No. 1 Display**

Displays the process value or parameter type.

**No. 2 Display**

Displays the set point, manipulated variable or set value (setup) of the parameter.

**Up Key**

Each press of this key increases values displayed on the No.2 display. Holding down this key continuously increases values.

**Down Key**

Each press of this key decreases values displayed on the No.2 display. Holding down this key continuously decreases values.

**Level + Mode Key**

This key combination sets the E5GN to the "protect level."

**Level Key**

Press this key to select the setup level. The setup level is selected in order "operation level" ↔ "adjustment level," "initial setting level" ↔ "communications setting level."

**Mode Key**

Press this key to select parameters within each level.



# Installation

## ■ E5AN/E5EN

### Mounting

1. Insert the E5AN/E5EN into the mounting hole in the panel from the front.
2. Push the mounting bracket along the E5AN/E5EN body from the terminals up to the panel, and secure it temporarily.
3. Tighten the fixing screw on each mounting bracket alternately until the ratchet stops tightening.

### E5AN

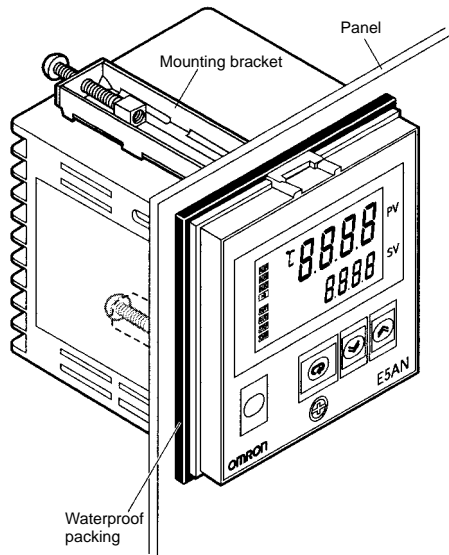

### E5EN

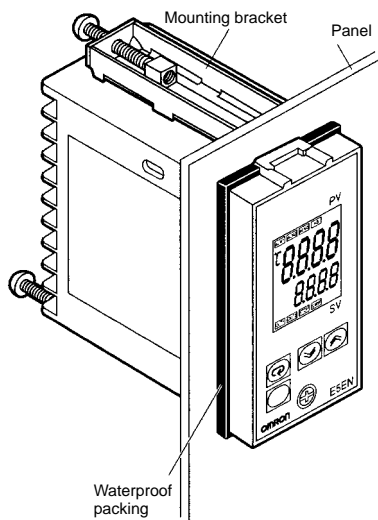

### Drawing Out

For drawing out the Unit, use a suitable Philips screwdriver for the screw located at the bottom on the front panel.

1. While pressing down on the hook located at the top of the front panel, turn the screw (located at the bottom on the front panel) counterclockwise using a Philips screwdriver.
2. Hold both sides of the front panel and draw out the Unit towards you.
3. When inserting the Unit, confirm that the waterproof packing is in place. While pressing down on the hook located at the top of the front panel, turn the screw (located at the bottom on the front panel) clockwise using a Philips screwdriver and tighten to a torque of 0.3 to 0.5 N·m. Make sure that electronic parts do not come in contact with the case.

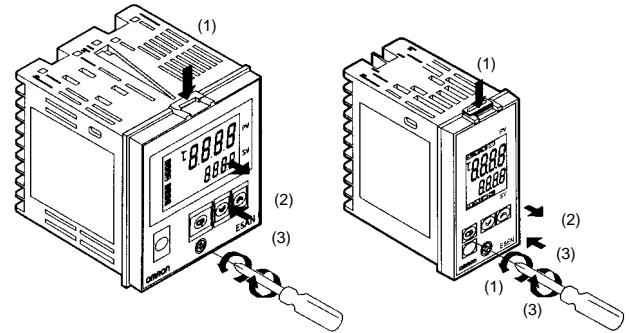

## ■ E5CN

### Setting Up Option Units

If communications, event input, or heater burnout functions are required, mount the E53-CNH03 Communications Unit or the E53-CNHB Event Input Unit. The heater burnout function is supported on either of these two Option Units.

#### Option Units

Name	Model	Function
Communications Unit	E53-CNH03	RS-485 communications
Event Input Unit	E53-CNHB	Event inputs

**Note:** Terminal label: x1

#### Assembling a Unit

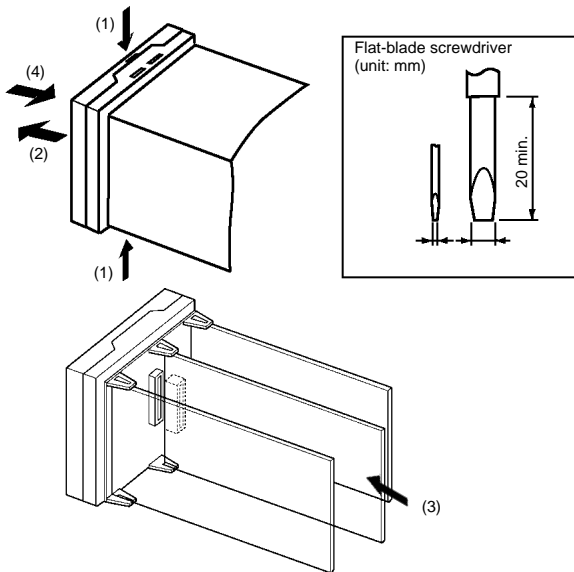

1. Insert the tools (see drawing above) into the slots (one on the top and one on the bottom) and release the hooks.
2. Insert the tool in the space between the front and rear panels and slightly pull out the front panel. Hold the top and bottom of the front panel and pull toward yourself to remove it.
3. Match up the upper and lower claws with the connection points and insert the Option Unit. Mount the Option Unit in the center.
4. Before inserting the Unit, confirm that the waterproof packing is in place. Insert the Unit into the rear case until you hear a click. When inserting the Unit, press down the hooks on the top and bottom of the rear case so that they firmly hook on the inserted Unit. Make sure that electronic parts do not come in contact with the case.

### Mounting

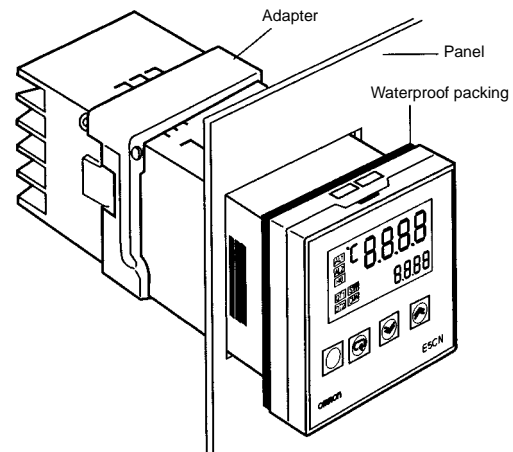

#### Attaching the E5CN to a Panel

1. Insert the E5CN into the mounting hole in the panel.
2. Push the adapter along the E5CN body from the terminals up to the panel, and secure it temporarily.
3. Tighten the two fixing screws on the adapter. When tightening screws, tighten the two screws alternately keeping the torque to between 0.29 and 0.39 N·m (2.9 kgf·cm to 3.9 kgf·cm).

#### Attaching the Terminal Cover

Make sure that the "UP" mark is facing up, and then fit the Terminal Cover (E53-COV10) into the holes on the top and bottom. A E5CN-500 Controller is provided with a Terminal Cover.

■ E5GN

Mounting

1. Insert the E5GN into the mounting hole in the panel from the front.
2. Push the adapter along the E5GN body from the terminals up to the panel, and secure it temporarily.
3. Tighten the two fixing screws on the adapter. When tightening screws, tighten the two screws alternately keeping the torque to within approximately 0.29 to 0.39 N·m.

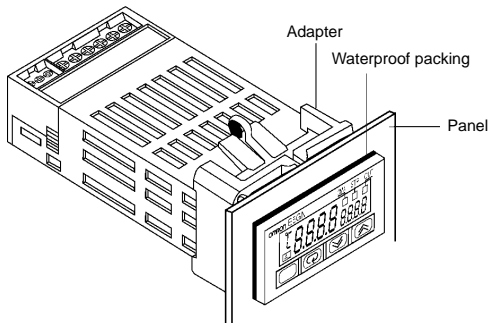

2. Draw out the terminal plate as it is.

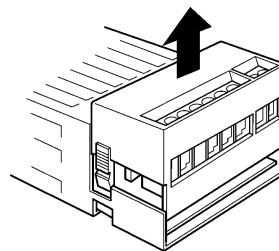

3. Before you insert the terminal plate again, make sure that the pins match the positions of the holes in the terminal plate.

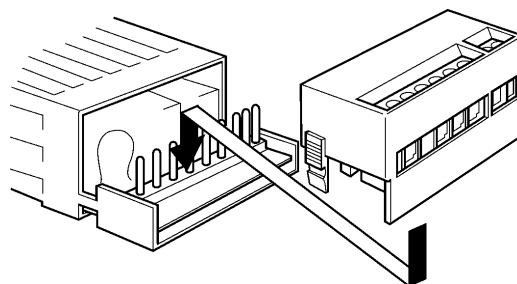

Removing and Attaching the Terminal Plate

The E5GN can be replaced by removing the terminal plate.

1. Press down hard on the fasteners on both sides of the terminals to unlock the terminal plate and pull upwards.

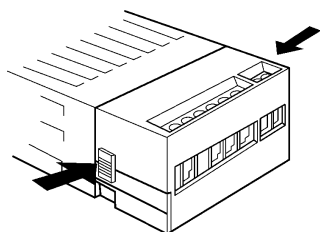

■ Wiring Precautions

E5AN/E5EN/E5CN

- Separate input leads and power lines to protect the E5AN/E5EN/E5CN and its lines from external noise.
- We recommend using solderless terminals when wiring the E5AN/E5EN/E5CN.
- Tighten the terminal screws using a torque between 0.74 and 0.90 N·m.
- Use the following type of solderless terminals for M3.5 screws.

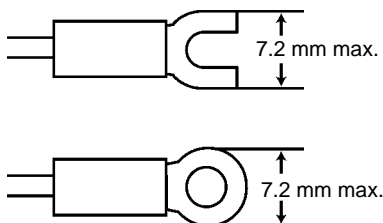

E5GN

- Connect the terminals as specified below.

Terminal No.	Cables	Pin terminals
1 to 6	AWG24 to AWG14	2.1 dia. max.
7 to 9	AWG28 to AWG22	1.3 dia. max.

- The exposed current-carrying part to be inserted into terminals must be 5 to 6 mm.

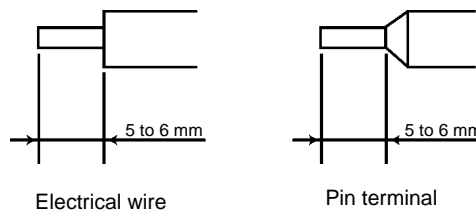

- Tighten the terminal screws to the torque specified below.

Terminal No.	Screw	Maximum tightening torque
1 to 6	M2.6	0.23 to 0.25 N·m
7 to 9	M2	0.12 to 0.14 N·m

# Operation

## Initial Setup

On previous Controllers, sensor input type, alarm type and control period were set on DIP switches. These hardware settings are now set in parameters in setup menus. The and keys are used to switch between setup menus, and the amount of time that you hold the keys down for determines which setup menu you move to. This section describes two typical examples.

**Note:** On the E5EN/E5GN, the Key is the Key.

### 1. ON/OFF Control

#### Typical Application Examples

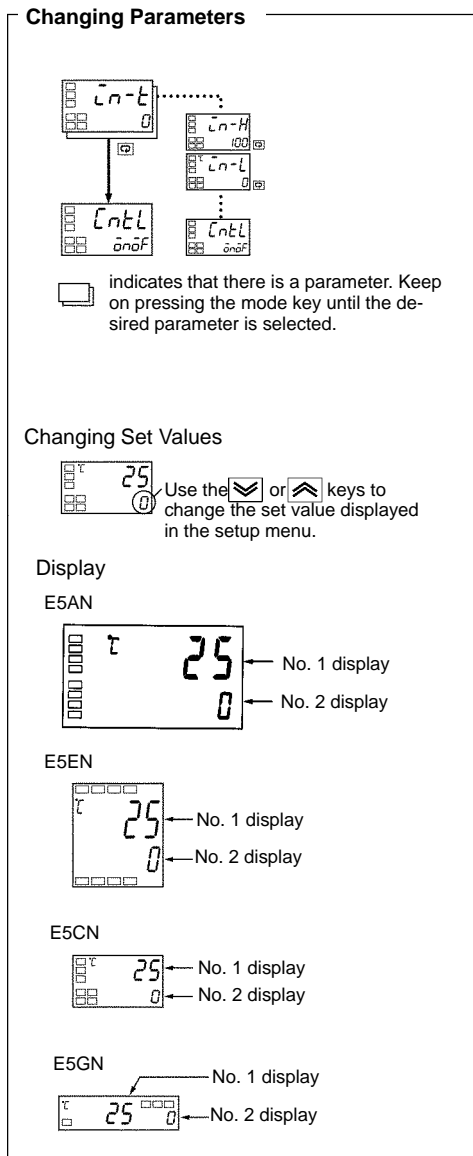

#### Typical Example

Input type: 0 K thermocouple -200 to 1300°C  
 Control method: ON/OFF control  
 Alarm type: 2 upper limit  
 Alarm value 1: 20°C (For setting deviation)  
 Set point: 100°C

Change only the alarm value 1 and set point.  
 The rest must be left as default settings.

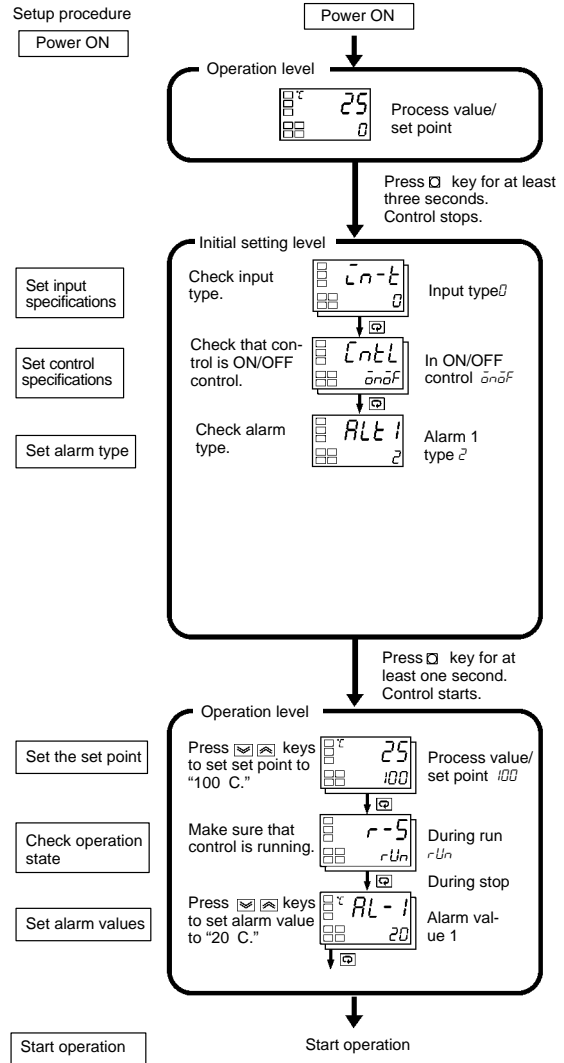

## 2. PID Control Using Auto-tuning

### Changing Parameters

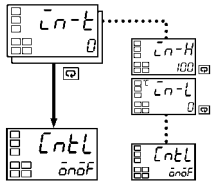

indicates that there is a parameter. Keep on pressing the mode key until the desired parameter is selected.

### Changing Set Values

Use the or keys to change the set value displayed in the setup menu.

### Display

E5AN

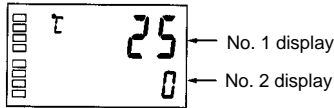

E5EN

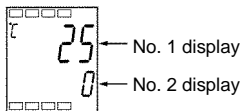

E5CN

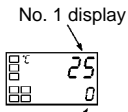

E5GN

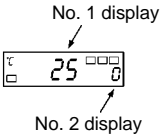

### Typical Example

Input type: 4 T thermocouple -200 to 400°C  
 Control method: PID control  
 ST (self-tuning): OFF  
 Calculate PID constants by AT (auto-tuning).  
 Alarm type: 2 upper limit  
 Alarm value 1: 30°C (For setting deviation)  
 Set point: 150°C

#### Setup procedure

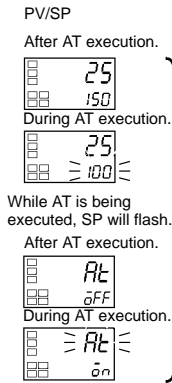
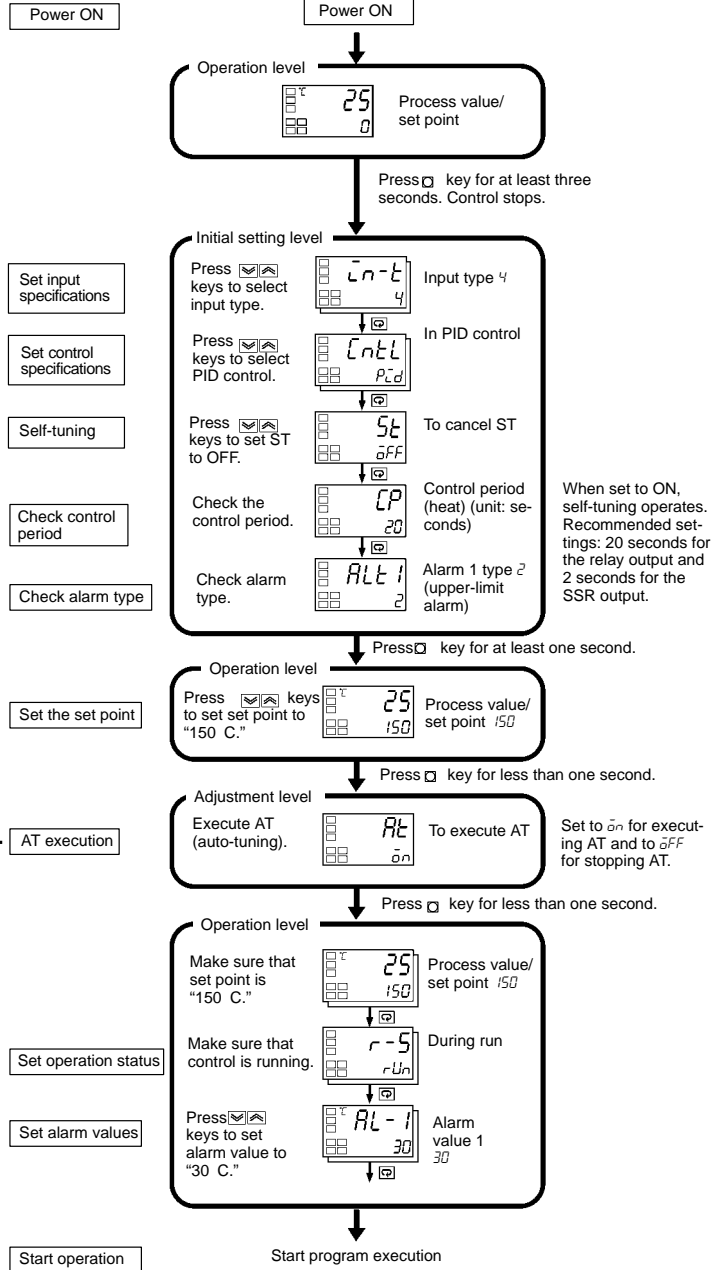

Set input specifications

Set control specifications

Self-tuning

Check control period

Check alarm type

Set the set point

AT execution

Set operation status

Set alarm values

# Specification Setting after Turning ON Power

## ■ Outline of Operation Procedures

### Key Operation

In the following descriptions, all the parameters are introduced in the display sequence. Some parameters may not be displayed depending on the protect settings and operation conditions.

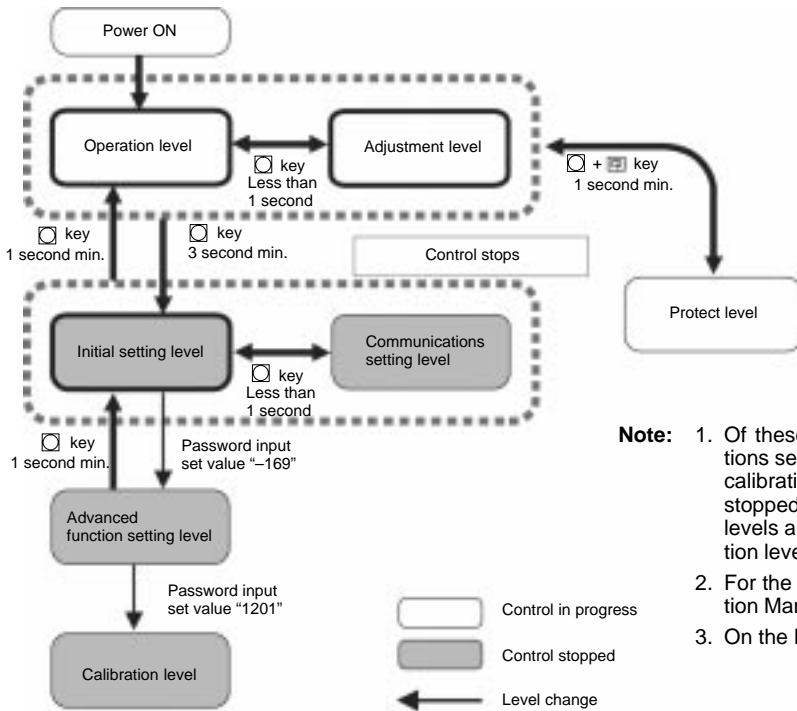

- Note:**
1. Of these levels, the initial setting level, communications setting level, advanced function setting level and calibration level can be used only when control has stopped. Note that control is stopped when these four levels are selected. When switched back to the operation level from one of these levels, control will start.
  2. For the calibration mode, refer to the relevant Operation Manual (H100 or H101).
  3. On the E5EN/E5GN, the Key is the Key.

## ■ Description of Each Level

### Operation Level

This level is displayed when you turn the power ON. You can move to the protect level, initial setting level and adjustment level from this level.

Normally, select this level during operation. During operation, the process value, set point and manipulated variable can be monitored, and the alarm value and upper- and lower-limit alarms can be monitored and modified.

### Adjustment Level

To select this level, press the key once for less than one second.

This level is for entering set values and offset values for control. This level contains parameters for setting the set values, AT (auto-tuning), communications writing enable/disable, hysteresis, multi-SP, input shift values, heater burnout alarm (HBA) and PID constants. You can move to the top parameter of the operation level or initial setting level from here.

### Initial Setting Level

To select this level, press the key for at least three seconds in the operation level. This level is for specifying the input type, selecting the control method, control period, setting direct/reverse action and alarm type. You can move to the advanced function setting level or communications setting level from this initial setting level. To return to the operation level, press the key for at least one second. To move to the communications setting level, press the key once for less than one second.

### Protect Level

To select this level, simultaneously press the and keys for at least one second. This level is to prevent unwanted or accidental modification of parameters. Protected levels will not be displayed, and so the parameters in that level cannot be modified.

### Communications Setting Level

To select this level, press the key once for less than one second in the initial setting level. When the communications function is used, set the communications conditions in this level. Communicating with a personal computer (host computer) allows set points to be read and written, and manipulated variables to be monitored.

### Advanced Function Setting Level

To select this level, you must enter the password ("-169") in the initial setting level.

You can move only to the calibration level from this level.

This level is for setting the automatic return of display mode, MV limiter, event input assignment, standby sequence, alarm hysteresis, ST (self-tune) and to move to the user calibration level.

### Calibration Level

To select this level, you must enter the password ("1201") in the advanced function setting level. This level is for offsetting deviation in the input circuit.

You cannot move to other levels by operating the keys on the front panel from the calibration level. To cancel this level, turn the power OFF then back ON again.

### ■ Specification Setting after Turning ON Power

#### Initial Setting Level

This level is used for setting basic specifications of the Temperature Controller. Using this level, set the input type for selecting the input to be connected such as the thermocouple or platinum resistance thermometer and set the range of set point and the alarm mode.

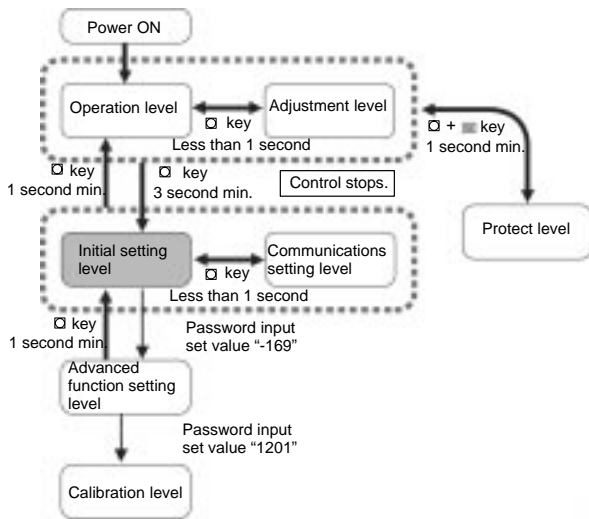

The move from the operation level to the initial setting level, press  key for three seconds or more.

The initial setting level is not displayed when “initial/communications protection” is set to “2.” This initial setting level can be used when “initial setting/communications protection” is set to “0” or “1.”

The “scaling upper limit,” “scaling lower limit,” and “decimal point” parameters are displayed when an analog voltage input is selected as the input type.

#### Initial setting level

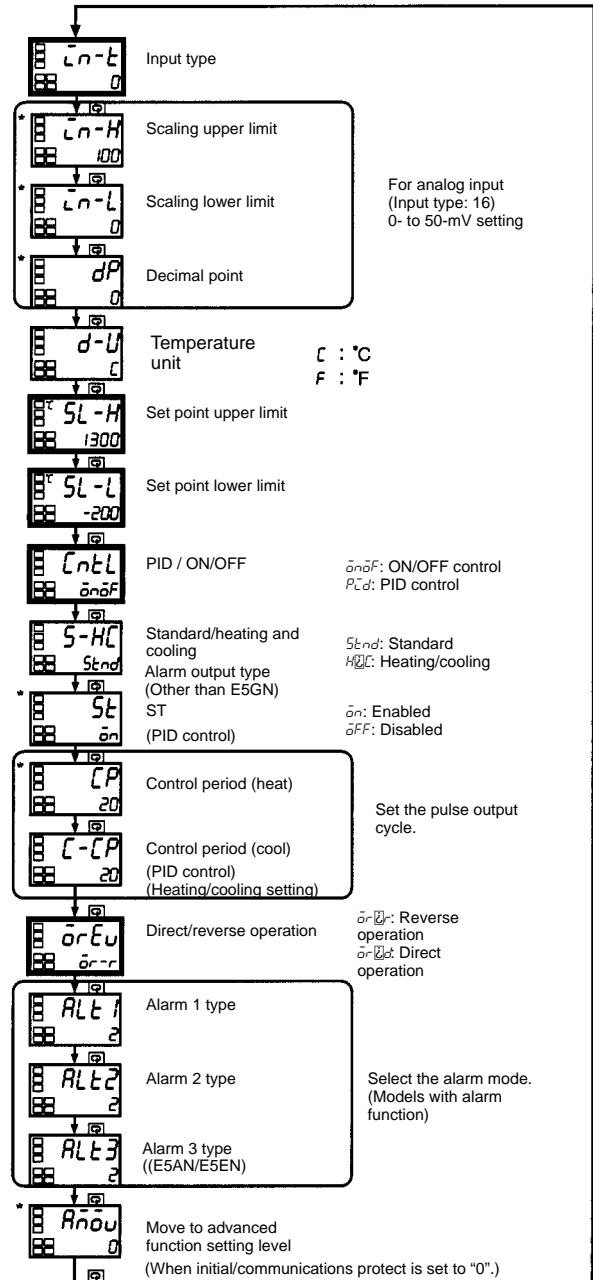

To return to the operation level, press the  key for longer than one second

\* Not displayed as default setting.

## ■ Input Type

When using a thermocouple input type, follow the specifications listed in the following table.

	Input Type	Specifications	Set Value	Input Temperature Range
Thermocouple input type	Thermocouple	K	0	-200 to 1300 (°C) /-300 to 2300 (°F)
			1	-20.0 to 500.0 (°C) /0.0 to 900.0 (°F)
		J	2	-100 to 850 (°C) /-100 to 1500 (°F)
			3	-20.0 to 400.0 (°C) /0.0 to 750.0 (°F)
		T	4	-200 to 400 (°C) /-300 to 700 (°F)
		E	5	0 to 600 (°C) /0 to 1100 (°F)
		L	6	-100 to 850 (°C) /-100 to 1500 (°F)
		U	7	-200 to 400 (°C) /-300 to 700 (°F)
		N	8	-200 to 1300 (°C) /-300 to 2300 (°F)
		R	9	0 to 1700 (°C) /0 to 3000 (°F)
		S	10	0 to 1700 (°C) /0 to 3000 (°F)
	B	11	100 to 1800 (°C) /300 to 3200 (°F)	
	Non-contact temperature sensor ES1A	K10 to 70 C	12	0 to 90 (°C) /0 to 190 (°F)
		K60 to 120 C	13	0 to 120 (°C) /0 to 240 (°F)
		K115 to 165 C	14	0 to 165 (°C) /0 to 320 (°F)
		K160 to 260 C	15	0 to 260 (°C) /0 to 500 (°F)
Analog input	0 to 50mV	16	One of following ranges depending on the results of scaling: 1999 to 9999, 199.9 to 999.9	

**Note:** The initial settings are: 0: -200 to 1300 C/-300 to 2300 F.

When using the platinum resistance thermometer input type, follow the specifications listed in the following table.

	Input Type	Specifications	Set Value	Input Temperature Range
Platinum resistance thermometer input type	Platinum resistance thermometer	Pt100	0	-200 to 850 (°C) /-300 to 1500 (°F)
			1	-199.9 to 500.0 (°C)/-199.9 to 900.0 (°F)
			2	0.0 to 100.0 (°C) /0.0 to 210.0 (°F)
		JPt100	3	-199.9 to 500.0 (°C)/-199.9 to 900.0 (°F)
			4	0.0 to 100.0 (°C) /0.0 to 210.0 (°F)

**Note:** The initial settings are: 0: Pt100 -200 to 850 C/-300 to 1500 F.  
The ES1A Non-contact Temperature Sensor is now available.



**Alarm 1 and Alarm 2**

For the alarm 1 and alarm 2, select alarm types out of the 12 alarm types listed in the following table. (The alarm 3 for E5AN/E5EN, which has three alarms, can also be selected from this table.)

Set Value	Alarm Type	Alarm Output Operation	
		When X is positive	When X is negative
0	Alarm function OFF	Output OFF	
1*1	Upper- and lower-limit (deviation)		*2
2	Upper-limit (deviation)		
3	Lower-limit (deviation)		
4*1	Upper- and lower-limit range (deviation)		*3
5*1	Upper- and lower-limit with standby sequence (deviation)		*4
6	Upper-limit with standby sequence (deviation)		
7	Lower-limit with standby sequence (deviation)		
8	Absolute-value upper-limit		
9	Absolute-value lower-limit		
10	Absolute-value upper-limit with standby sequence		
11	Absolute-value lower-limit with standby sequence		

\*1: With set values 1, 4 and 5, the upper and lower limit values can be set independently for each alarm type, and are expressed as "L" and "H."  
 Following operations are for cases when an alarm set point is "X" or negative.

\*2: Set value: 1, upper- and lower-limit alarm

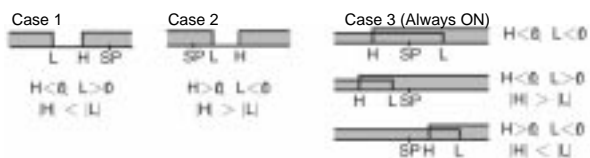

\*3: Set value: 4, upper- and lower-limit range

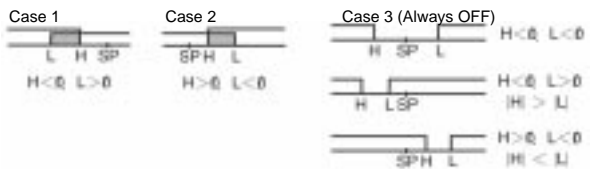

\*4: Set value: 5, upper- and lower-limit with standby sequence

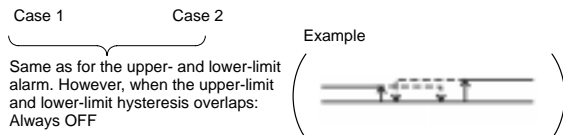

Example: When the alarm is set ON at 110 C/ F or higher.

**When an alarm type other than the absolute-value alarm is selected**

(For alarm types 1 to 7)  
 The alarm value is set as a deviation from the set point.

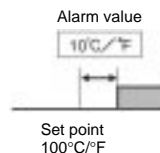

**When the absolute-value alarm is selected**

(For alarm types 8 to 11)  
 The alarm value is set as an absolute value from the alarm value of 0 C/F.

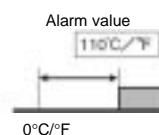

\*5: Set value: 5, upper- and lower-limit with standby sequence alarm. Always OFF when the upper-limit and lower-limit hysteresis overlaps.

Set the alarm types for alarm 1 and alarm 2 independently in the initial setting level. The default setting is 2 (upper limit). With the E5AN/E5EN, perform settings similarly for alarm 3.

■ Parameters

Parameters related to setting items for each level are marked in boxes in the flowcharts and brief descriptions are given as required. At the end of each setting item, press the mode key to return to the beginning of each level.

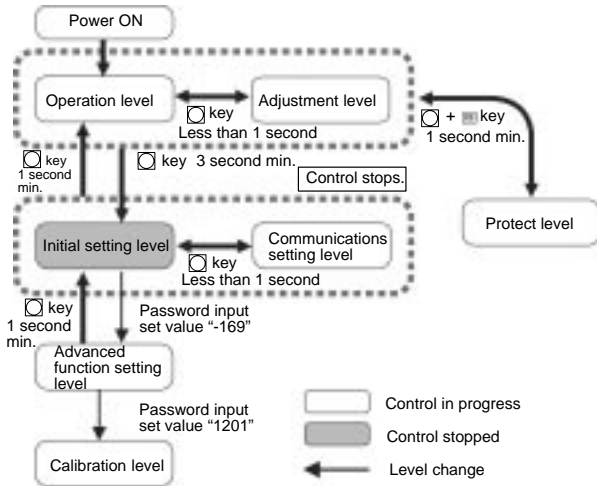

Display

E5AN

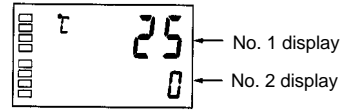

E5EN

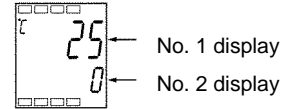

E5CN

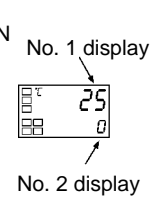

E5GN

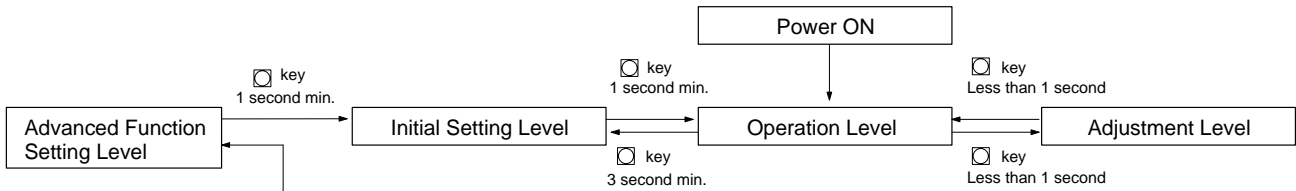
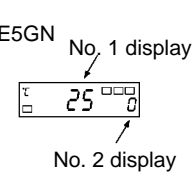

**Note:** To select advanced function setting level, you must enter the password ("-169") in the initial setting level.

Advanced Function Setting Level

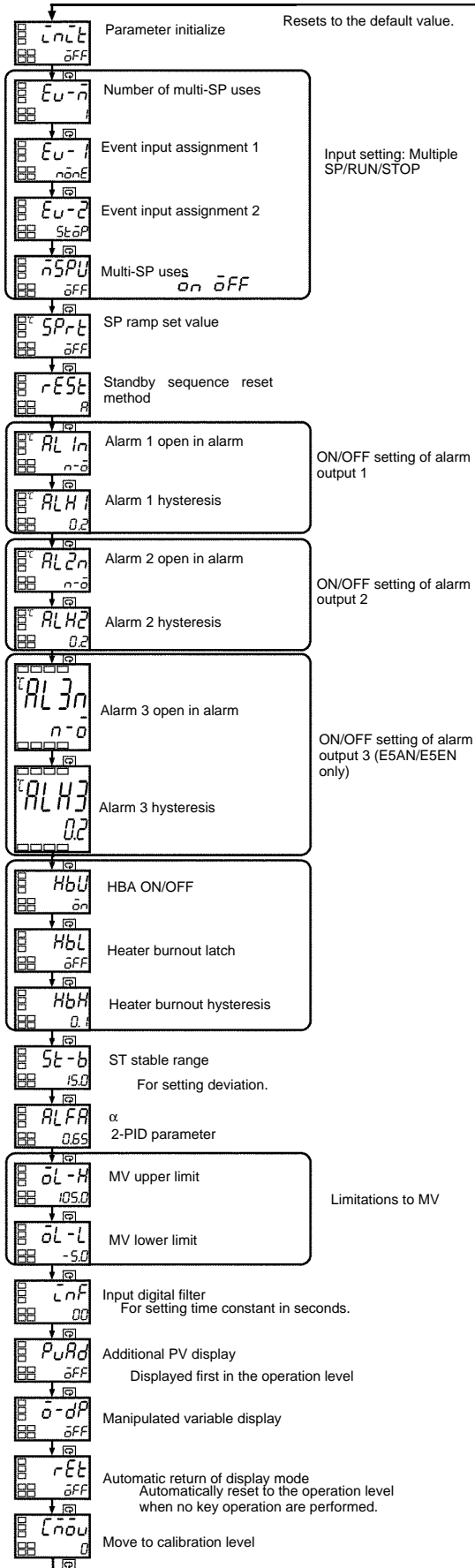

Initial Setting Level

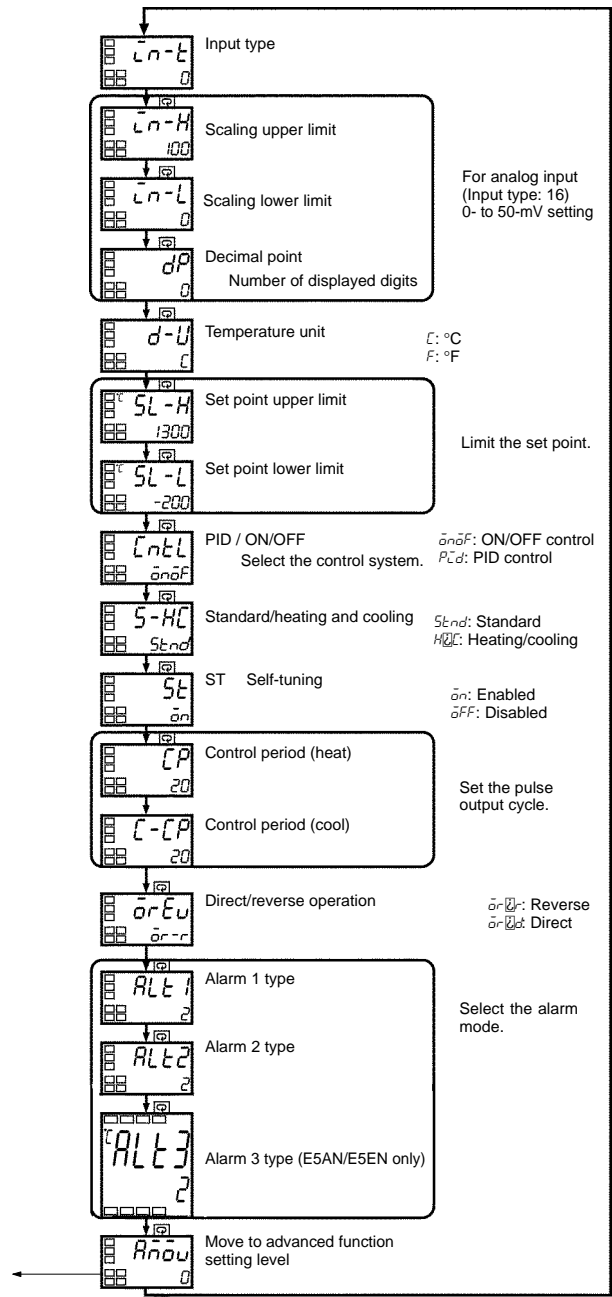

**Note:** To select advanced function setting level, you must enter the password ("169") in the initial setting level.

**Note:** These diagrams show all the parameters that may be displayed. Depending on the specifications of the model used, there may be some parameters that are not displayed. The following symbols are used to distinguish between these parameters.

- : Displayed for all models regardless of the settings of other parameters.
- : Not displayed for some models.
- : Depending on the settings of other parameters, may not be displayed.

Operation Level

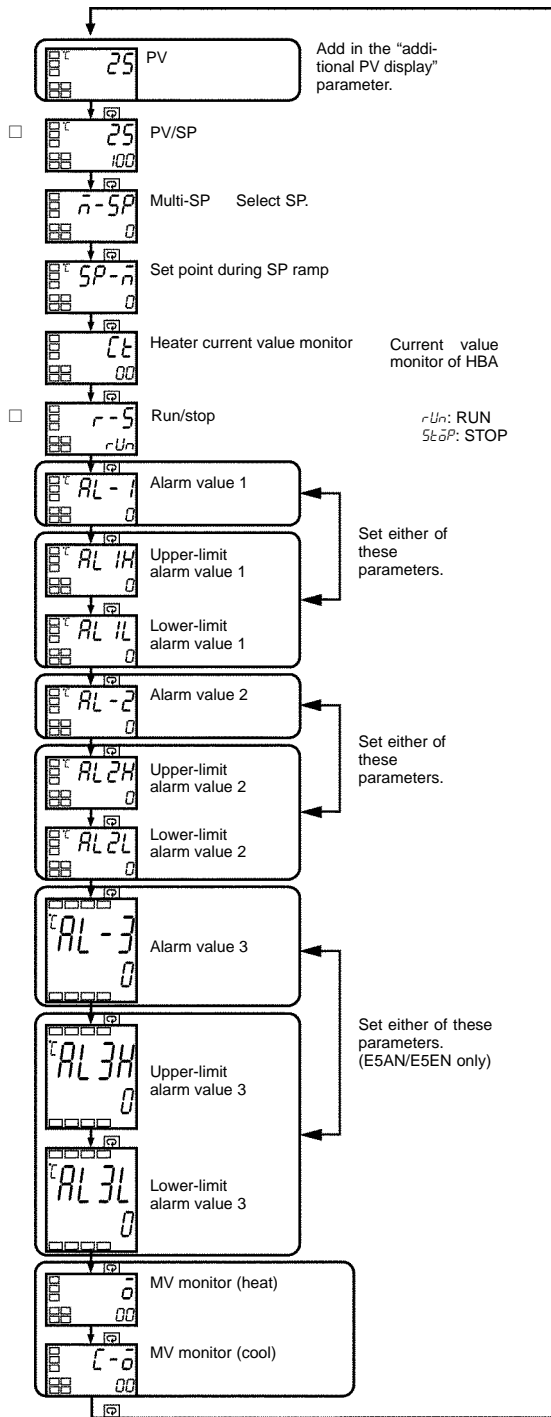

Adjustment Level

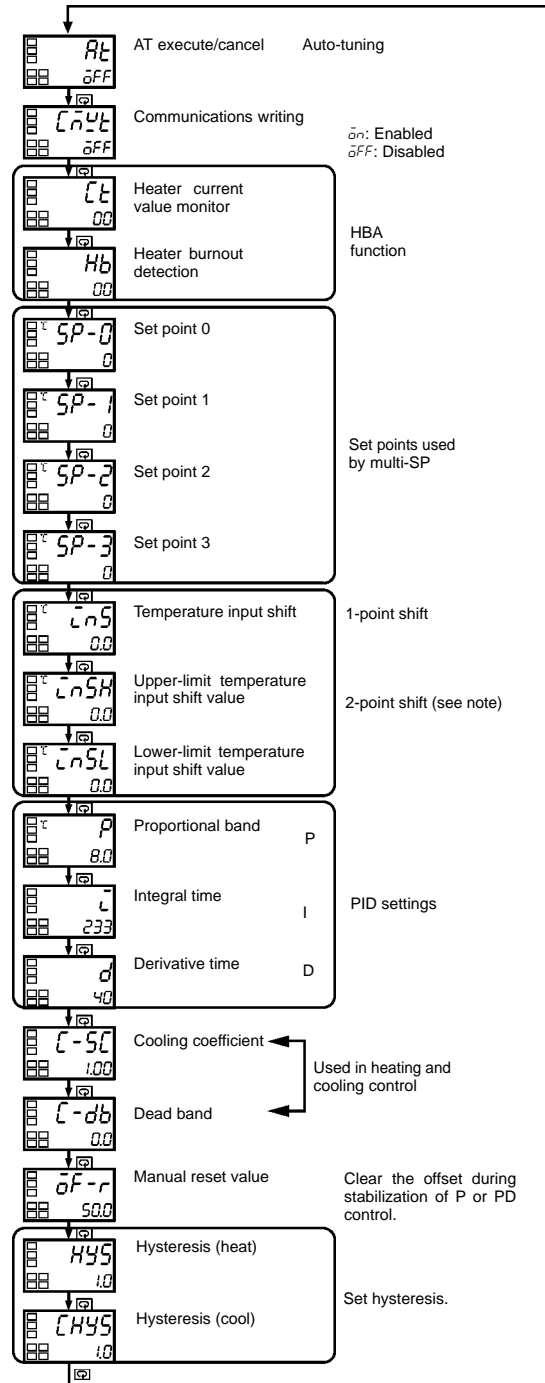

The 2-point shift setting is only possible when the input type is a non-contact temperature sensor.

The displays for parameters which can be switched (i.e., parameters other than simply numerical ones) show the contents of those parameters.

**Note:** These diagrams show all the parameters that may be displayed. Depending on the specifications of the model used, there may be some parameters that are not displayed. The following symbols are used to distinguish between these parameters.

- : Displayed for all models regardless of the settings of other parameters.
- : Not displayed for some models.
- : Depending on the settings of other parameters, may not be displayed.

## Protect Level



Operation/adjustment protection

Restricts display and modification of menus in the operation and adjustment levels.

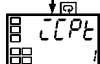

Initial setting/communications protection

Restricts display and modification of menus in the initial setting, operation level and adjustment levels.

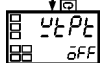

Setting change protection

Protects changes to setups by operating the front panel keys.

## Operation/Adjustment Protection

The following table shows the relationship between set values and the range of protection.

Level		Set value			
		0	1	2	3
Operation level	PV	<input type="checkbox"/>	<input type="checkbox"/>	<input type="checkbox"/>	<input type="checkbox"/>
	PV/SP	<input checked="" type="checkbox"/>	<input checked="" type="checkbox"/>	<input checked="" type="checkbox"/>	<input type="checkbox"/>
	Other	<input checked="" type="checkbox"/>	<input checked="" type="checkbox"/>	X	X
Adjustment level		<input checked="" type="checkbox"/>	X	X	X

When this parameter is set to "0," parameters are not protected.

Default setting: 0

: Can be displayed and changed

: Can be displayed

X : Cannot be displayed and move to other levels not possible

## Initial Setting/Communications Protection

This protect level restricts movement to the initial setting level, communications setting level and advanced function setting level.

Set value	Initial setting level	Communications setting level	Advanced function setting level
0	<input type="checkbox"/>	<input type="checkbox"/>	<input type="checkbox"/>
1	<input type="checkbox"/>	<input type="checkbox"/>	X
2	X	X	X

Default setting: 1

: Move to other levels possible

X : Move to other levels not possible

## Setting Change Protection

This protect level protects setup from being changed by operating the keys on the front panel.

Set value	Description
OFF	Setup can be changed by key operation.
ON	Setup cannot be changed by key operation. (The protect level, can be changed.)

Default setting: OFF

**Communications Setting Level**

Set the E5AN/E5EN/E5CN/E5GN communications specifications in the communications setting level. For setting communications parameters, use the E5AN/E5EN/E5CN/E5GN panel. The communications parameters and their settings are listed in the following table.

Parameter	Displayed characters	Set (monitor) value	Set value
Communications unit No.	U-nō	0 to 99	0.1 to 99
Baud rate	P5	1.2/2.4/4.8/9.6/19.2 (kbps)	1.2/2.4/4.8/9.6/19.2
Data bits	n	7/8 (bit)	7/8 (bit)
Stop bits	5 ĩt	1/2	1.2 (bit)
Parity	P-rĩ	None, even, odd	nōn / U-n/ōdd

**Note:** The highlighted values indicate default settings.

Before executing communications with the E5AN/E5EN/E5CN/E5GN, set the communications unit No., baud rate, etc., through key operations as described below. As for other operations, refer to relevant Operation Manual.

1. Press the key for at least three seconds in the "operation level." The level moves to the "initial setting level."
2. Press the key for less than one second. The "initial setting level" moves to the "communications setting level."
3. Pressing the key advances the parameters as shown in the following figure.
4. Press the or keys to change the parameter setups.

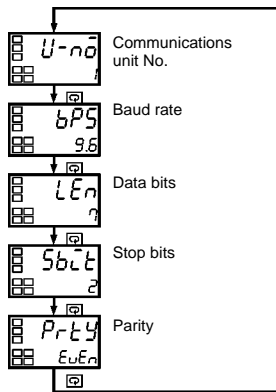

**Note:** On the E5AN/E5EN/E5GN, the Key is the Key.

Set each communications parameter to match those of the communicating personal computer.

**■ Troubleshooting**

When an error occurs, an error code will be displayed on the No. 1 display. Check the contents of an error and take appropriate countermeasures.

No. 1 display	Type of error	Countermeasures
5 r r	Input error	Check the wiring of inputs for miswiring, disconnections, short-circuits, and the input type.
!!!	Memory error	First, turn the power OFF then back ON again. If the display remains the same, the Unit must be repaired. If the display is restored, then a probable cause can be external noise affecting the control system. Check for external noise.
cccc	Display range over	Though not error, this is displayed when the process value exceeds the display range when the control range is larger than the display range.
cccc		<ul style="list-style-type: none"> <li>• When less than "-1999" (-199.9)      c c c c</li> <li>• When larger than "9999" (999.9)      c c c c</li> </ul>
H r r	HB error	First, turn the power OFF then back ON again. If the display remains the same, the E5EN/E5CN/E5GN must be repaired. If the display is restored, then a probable cause can be electrical noise affecting the control system. Check for electrical noise.

**Note:** Error will be displayed only when the display is set for the PV or PV/SP.

**Communications Unit No. (U-nō)**

When communicating with the host computer, the unit number must be set in each Temperature Controller so that the host computer can identify each Temperature Controller. The number can be set in a range from 0 to 99 in increments of 1. The default setting is 1. When using more than one Unit, be careful not to use the same number twice. Duplicate settings will cause malfunction. This value becomes valid when the power is turned OFF and ON again.

**Baud Rate ( P5)**

Use this parameter to set the speed of communications with the host computer. It can be set to one of the following values; 1.2 (1200 bps), 2.4 (2400 bps), 4.8 (4800 bps), 9.6 (9600 bps), and 19.2 (19200 bps).

This setting becomes valid when the power is turned OFF and ON again.

**Data Bits ( n)**

Use this parameter to change the communications data bit length to 7 bits or 8 bits.

**Stop Bits ( 5 ĩt)**

Use this parameter to change the communications stop bit to 1 or 2.

**Parity ( P-rĩ )**

Use this parameter to set the communications parity to None, Even, or Odd.

## Fuzzy Self-tuning

The fuzzy self-tuning (ST) is a function that automatically calculates an optimum PID constant depending on items to be controlled.

### ■ Feature

The Temperature Controller determines when to execute this fuzzy self-tuning.

### ■ Functions

SRT: Performs PID tuning according to the step response method when the SP is changed.

### Requirements for SRT Functionality

The ST will be executed according to the step response method when the following conditions are satisfied when operation is started or when the SP is changed.

When operation is started	When SP is changed
<ol style="list-style-type: none"> <li>1. The SP at the startup is different from the SP at the time the previous SRT was executed. (See note.)</li> <li>2. The temperature upon startup is smaller than the SP in the reverse operation and larger than the SP in the direct operation.</li> <li>3. Restarting of operation is not due to an input error.</li> </ol> <p><b>Note:</b> The "SP that existed when the previous SRT was executed" refers to the SP used for obtaining the PID constant in the previous SRT.</p>	<ol style="list-style-type: none"> <li>1. The SP after change is different from the SP at the time the previous SRT was executed. (See note.)</li> <li>2. In the reverse operation, the value obtained by deducting the SP before change from the SP after change is larger than the ST stable range. In the direct operation, the value obtained by deducting the SP after change from the SP before change is larger than the ST stable range.</li> <li>3. The SP change width is larger than the current proportional band <math>\times 1.27 + 4</math>.</li> <li>4. The temperature is in the stable state. (It can be in the balanced state if no output is generated when the power is turned ON.)</li> </ol>

If the SP is changed while SRT is being executed and if SRT completion conditions are satisfied, no PID change will take place.

### Stabilization State

Measured values remain in the stable range for a certain period of time.

### Balanced State

Output is 0% for 60 seconds and measured values fluctuate within the width of the stable range.

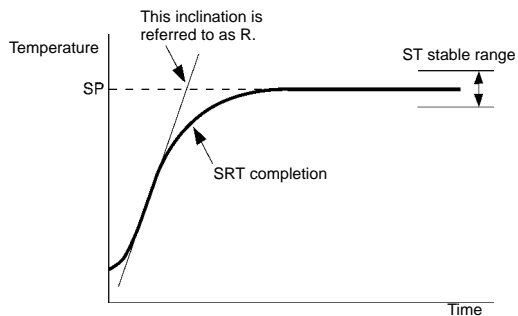

# Peripheral Devices

## Temperature Sensor / SSR

### Connection Example with SSR

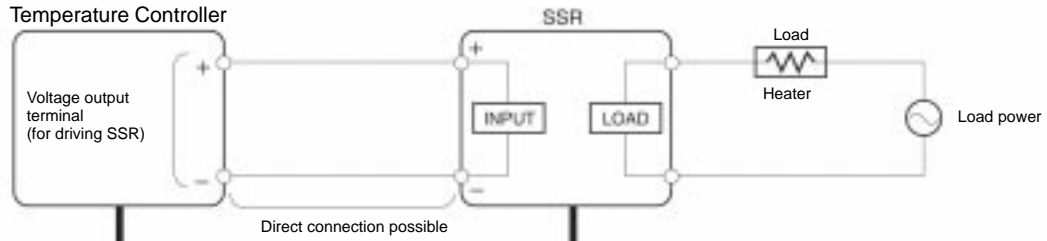

**E52**

**E51A**

**E5AN**

**E5EN**

**E5CN**

**E5GN**

3 units 5 units (E5AN/ E5EN)	G3PB (Single-phase): 240 VAC 15 A, 25 A, 35 A, 45 A	
	Rated input voltage: 12 to 24 VDC	
	Compact and slim models with a built-in radiator	
2 units 4 units (E5AN/ E5EN)	G3PB (Three-phase): 240 VAC/400 VAC (15 A, 25 A, 35 A, 45 A)	
	Rated input voltage: 12 to 24 VDC	
	Simultaneous three-phase control with a built-in radiator	
3 units 5 units (E5AN/ E5EN)	G3PA: 240 VAC (10 A, 20 A, 40 A) 400 VAC (20 A, 30 A)	
	Rated input voltage: 5 to 24 VDC	
	Compact and slim models with a built-in radiator	
3 units 5 units (E5AN/ E5EN)	G3NA: 240 VAC (5 A, 10 A, 20 A, 40 A) 480 VAC (10 A, 20 A, 40 A)	
	Rated input voltage: 5 to 24 VDC	
	Standard models with screw terminals	
1 unit 2 units (E5AN/ E5EN)	G3NE: 240 VAC (5 A, 10 A, 20 A)	
	Rated input voltage: 12 VDC	
	Compact and low-cost models with tab terminals	
4 units 8 units (E5AN/ E5EN)	G3NH: 440 VAC (75 A, 150 A)	
	Rated input voltage: 5 to 24 VDC	
	For controlling high-power heater	



## Responding to All Demands for Temperature Control in Wide Application Range

### ■ ES1A Non-contact Temperature Sensor

Replaces the K-type thermocouple with no modification required.

Available soon.



**Note:** Refer to the ES1A Datasheet (H106) for more details.

#### Only One-tenth the Size of OMRON's Conventional Model

The ES1A-A is as compact as 14 x 18.6 x 34 (W x H x D) mm and can be built into machines and equipment with ease.

#### No Power Supply Required

The ES1A Series has electromotive output that is as high as the output of the thermocouple, thus allowing direct connection to the thermocouple input terminal of the Temperature Controller without requiring any external power supply.

#### Available for High Ambient Temperatures

The ES1A Series performs accurate measurement without being influenced by the ambient temperature. In particular, the ES1A-C with air purge function can operate at an ambient temperature of up to 120°C.

ES1A-A	-25 to 70°C
ES1A-B	-25 to 100°C
ES1A-C with air purge function	-25 to 120°C

### ■ G3PB SSC for Three-phase Heaters

Compact, low-cost model for three-phase heater control.



#### Saves 40% on Installation Space

The G3PB is dedicated to three-phase heater control and saves 40% on installation space compared with three single-phase models mounted closely side-by-side.

(This comparison is based on the use of three G3PA-240B-VD models and one G3PB-245B-3-VD.)

**Note:** Refer to the G3PB Datasheet (J112) for more details.

### ■ E52-series Temperature Sensors

#### Offers a Wide Variety of High-precision Temperature Sensors

- Used as Sensors for Temperature Controllers.
- Ensures easy selection of the most suitable model according to the temperature, place, and environment.
- Offers a wide variety of models that are different in type, appearance, length, and terminal shape.
- Low-cost models and dedicated models, as well as general-purpose models, are available.

**Note:** Refer to the E52 Datasheet (H097) for more details.



# Precautions

## ■ General Precautions

The user must operate the product according to the performance specifications described in the operation manuals.

Before using the product under conditions which are not described here or applying the product to nuclear control systems, railroad systems, aviation systems, vehicles, combustion systems, medical equipment, amusement machines, safety equipment, and other systems, machines, and equipment that may have a serious influence on lives and property if used improperly, consult your OMRON representative.

Make sure that the ratings and performance characteristics of the product are sufficient for the systems, machines, and equipment, and be sure to provide the systems, machines, and equipment with double safety mechanisms.

## ■ Safety Precautions

### Definition of Precautionary Information

 **DANGER** Indicates an imminently hazardous situation which, if not avoided, will result in death or serious injury.

 **WARNING** Indicates a potentially hazardous situation which, if not avoided, could result in death or serious injury.

 **Caution** Indicates a potentially hazardous situation which, if not avoided, may result in minor or moderate injury, or property damage.

### Installation Precautions

 **WARNING** Do not attempt to take any Temperature Controller apart while the power is being supplied. Doing so may result in electric shock.

 **WARNING** Do not touch any of the terminals or terminal blocks while the power is being supplied. Doing so may result in electric shock.

 **WARNING** Do not allow pieces of metal or wire cuttings to get inside the Temperature Controller. Failure to do so may result in malfunction, electric shock or fire.

 **WARNING** Do not attempt to disassemble, repair, or modify the Temperature Controller. Any attempt to do so may result in malfunction, fire, or electric shock.

 **Caution** Do not use the Temperature Controller in locations subject to flammable gases. Doing so may result in an explosion.

 **Caution** The switching capacity and switching conditions will have a great effect on the longevity of the output relays. Use the Temperature Controller within the rated load and do not use the Temperature Controller beyond the number of operations specified under electrical life. Using the Temperature Controller beyond its electrical life may result in contact welding or burning.

 **Caution** Do not use the Temperature Controller at loads greater than the rated value. Doing so may result in burning or other damage.

 **Caution** Use a power supply voltage within the specified range. Failure to do so may result in burning or other damage.

 **Caution** Tighten the terminal screws to the following torques:  
E5AN, E5EN, E5CN: 0.74 to 0.90 N·m  
E5GN: Terminals 1 to 6: 0.23 to 0.25 N·m  
Terminals 7 to 9: 0.12 to 0.14 N·m  
Failure to tighten terminal screws to the correct torque may result in fire or malfunction.

 **Caution** Make settings for the Temperature Controller that are suitable for the controlled system. Failure to do so may cause unexpected operation resulting in damage to equipment or personal injury.

 **Caution** Prepare a circuit with an overheating prevention alarm and take other safety measures to ensure safe operation in the event of a malfunction. Loss of operational control due to malfunction may result in a serious accident.

## ■ Operating Environment Precautions

 **Caution** In order to ensure the safe operation, observe the following precautions.

- Do not use the Temperature Controller in the following places:
  - Locations exposed to radiated heat from heating devices
  - Locations subject to direct sunlight
  - Locations subject to temperatures or humidity outside the range specified in the specifications
  - Locations subject to condensation as the result of severe changes in temperature
  - Locations subject to corrosive or flammable gases
  - Locations subject to dust (especially iron dust) or salts
  - Locations subject to exposure to water, oil, or chemicals
  - Locations subject to shock or vibration
- Use and store the Temperature Controller within the rated temperature and humidity specified for each model. When two or more Temperature Controllers are mounted horizontally close to each other or vertically next to one another, the internal temperature will increase due to heat radiated by the Temperature Controllers and the service life will decrease. In such a case, forced cooling by fans or other means of air ventilation will be required to cool down the Temperature Controllers. When providing forced cooling, however, be careful not to cool down the terminal sections alone to avoid measurement errors.
- Allow enough space around the Temperature Controller to ensure proper heat dissipation. Do not block the ventilating holes.
- Check polarities and orientation when connecting terminals. Not doing so may result in malfunction.
- When wiring the E5AN, E5EN, or E5CN, use crimp terminals with the specified dimensions (M3.5, width 7.2 mm max.).
- When wiring the E5GN, use cables of a thickness AWG24 (0.205 mm<sup>2</sup>) to AWG14 (2.081 mm<sup>2</sup>) for terminals 1 to 6 and use cables of a thickness AWG28 (0.081 mm<sup>2</sup>) to AWG22 (0.326 mm<sup>2</sup>) for terminals 7 to 9. The exposed current-carrying part to be inserted into terminals must be 5 to 6 mm.
- Do not use empty terminals.
- To avoid inductive noise, keep the wiring for the Temperature Controller's terminal board away from power cables carry high voltages or large currents. Also, do not wire power lines together with or parallel to Temperature Controller wiring. Using shielded lines to separate pipes and ducts is recommended. Attach surge absorbers or noise filters to peripheral devices that may generate noise, such as inductance devices (e.g., motors, transformers, solenoids, magnetic coils etc.). If using a noise filter with the power supply, in addition to confirming the voltage and the current, mount the power supply as near as possible to the Temperature Controller. Set up the Temperature Controller, along with its power supply, as far away as possible from devices that generate strong, high-frequency waves (high-frequency welders, high-frequency machines etc.) and devices that generate surges.
- Set up the power supply so that the voltage will reach the rated voltage within 2 seconds after turning ON.
- Allow at least 30 minutes for the Temperature Controller to warm up.
- When using auto-tuning, turn ON power for the load (e.g., heater) at the same time as or before supplying power to the Temperature Controller. If power is turned ON for the Temperature Controller before turning ON power for the load, auto-tuning will

not be performed properly and optimum control will not be achieved.

- In order that power can be turned OFF in an emergency by the person operating the Temperature Controller, install the appropriate switches and circuit breakers and label them accordingly.
- With the E5AN, E5EN, or E5CN, when drawing out the Temperature Controller body, do not touch or apply excessive force. After the body is drawn out do not touch the terminals or electronic parts. When inserting, make sure that electronic parts do not come in contact with the case.
- When the terminal block for the E5GN is detached, do not touch or apply excessive force to any electronic parts.
- Use alcohol to clean the Temperature Controller. Do not use thinner or other solvent-based substances.

## ■ Correct Use

### Service Life

Use the Temperature Controller within the following temperature and humidity ranges:

Temperature:  $-10^{\circ}\text{C}$  to  $55^{\circ}\text{C}$  (with no icing or condensation)

Humidity: 25% to 85%

When the Temperature Controller is installed inside a control panel, ensure that the temperature around the Temperature Controller, not the temperature around the control panel, does not exceed  $55^{\circ}\text{C}$ .

The service life of relays used for the control output or alarm output largely varies depending on switching conditions. Be sure to confirm their performance under actual operating conditions and do not use them beyond the allowable number of switchings. If they are used in a deteriorated condition, insulation between circuits may be damaged and, as a result, the Temperature Controller itself may be damaged or burnt.

The service life of electronic devices such as Temperature Controllers is determined not only by the number of switchings of relays but also by the service life of internal electronic components. Component service life is affected by the ambient temperature: the higher the temperature becomes, the shorter the service life becomes and, the lower the temperature becomes, the longer the service life becomes. Therefore, the service life can be extended by lowering the temperature of the Temperature Controller using fans or other means of air ventilation. When providing forced cooling, however, be careful not to cool down the terminals sections alone to avoid measurement errors.

### Measurement Accuracy

When extending or connecting the thermocouple lead wire, be sure to use compensating wires that match the thermocouple types.

When extending or connecting the lead wire of the platinum resistance thermometer, be sure to use wires that have low resistance.

When wiring the platinum resistance thermometer to the Temperature Controller, keep the wire route as short as possible. Separate this wiring away from the power supply wiring and load wiring to avoid inductive or other forms of noise.

Mount the Temperature Controller so that it is horizontally level.

If the measurement accuracy is low, check that input shift has been set correctly.

### Waterproofing

The degree of protection is as shown below. Sections without any specification on their degree of protection or those with IP□0 have not been waterproofed.

Front panel: NEMA4 indoor use (equivalent to IP 66)

Rear case: IP 20

Terminal section: IP 00

### Operating Precautions

It takes approximately four seconds for the outputs to turn ON from the moment the power is turned ON. Due consideration must be given to this time when incorporating Temperature Controllers in a sequence circuit.

When using auto-tuning, supply power to the load (e.g., heater) at the same time as or before supplying power to the Temperature Controller. If power is turned ON for the Temperature Controller before turning ON power for the load, auto-tuning will not be performed properly and optimum control will not be achieved.

When starting operation after the Temperature Controller has warmed up, turn OFF the power and then turn it ON again at the same time as turning ON power for the load. (Instead of turning the Temperature Controller OFF and ON again, switching from STOP mode to RUN mode can also be used in this case.)

If the Temperature Controller is used close to radios, television sets or wireless devices it may affect reception.

In the case of Temperature Controllers with alarm outputs, alarm output may not be generated properly when an abnormality occurs in the device. It is suggested that a separate alarm device be incorporated in the system.

To ensure proper performance, parameters of the Temperature Controllers are set to default values before they are shipped. Change these parameters depending on actual applications. If left unchanged, the Temperature Controller will operate under the default settings.

### Crimp Terminal Connection

Use crimp terminals that match M3.5 screws. M3.5 x 8 self-rising screws are used.

E5AN/E5EN/E5CN



Be careful not to excessively tighten the terminals screws.

### Soldering Connection

The self-rising screws provide easy soldering connection. Strip the lead wire by a length of 6 to 8 mm and properly treat the terminal tip.

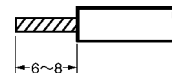

**ALL DIMENSIONS SHOWN ARE IN MILLIMETERS.**  
To convert millimeters into inches, multiply by 0.03937. To convert grams into ounces, multiply by 0.03527.

Cat. No. H107-E1-4 **In the interest of product improvement, specifications are subject to change without notice.**

**OMRON Corporation**

Industrial Automation Company

Measuring and Supervisory Controls Division  
28th Fl., Crystal Tower Bldg.,  
1-2-27, Shiromi, Chuo-ku,  
Osaka 540-6028 Japan  
Tel: (81)6-6949-6035 Fax: (81)6-6949-6069

Printed in Japan  
0999-1.5M (1098)