

HBE 6 SCREW & CRIMP TERMINATED INSERTS

SCREW TERMINATED

CRIMP TERMINATED

View from Cable Side

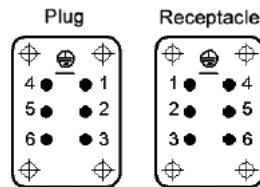

Contacts Sold Separately

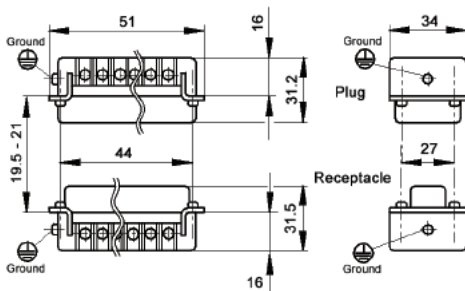

All dimensions are in mm.

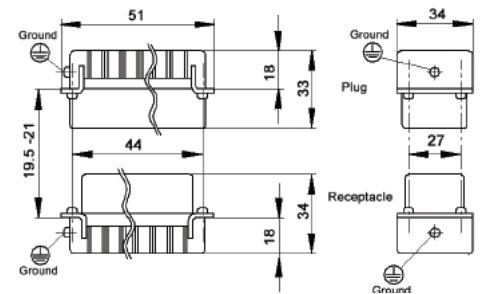

Description	Plug	Receptacle
Screw Terminated with wire protection	10190000	10191000
Screw Terminated without wire protection	10190100	10191100
Crimp Terminated: Machine	10180000	10181000



MACHINED CONTACTS: DIAMETER 2.5 MM²

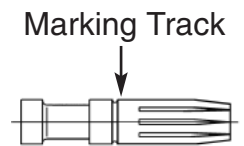
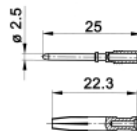

Bags of 100							
mm ²	AWG	Silver		Gold		Stripping Length (mm)	# of Marking Tracks
		Pin	Socket	Pin	Socket		
0.5	20	11190000	11195000	11192000	11197000	Pin=7.4, Socket =7.3	-
.75 - 1.0	18	11190100	11195100	11192100	11197100	Pin=7.4, Socket =7.3	1
1.5	16	11190200	11195200	11192200	11197200	Pin=7.4, Socket =7.3	2
2.5	14	11190300	11195300	-	-	Pin=7.4, Socket =7.3	3
4.0	12	11190400	11195400	-	-	Pin=7.4, Socket =7.3	-

Part number= 1 contact



Crimp Tool
11147000



Crimp Dies
11147100



Locator
11147200

For removal of contacts use a slotted screwdriver.
No special tool is necessary.

Please note that the crimp range for this tool is 0.14 to 4.0 mm² (AWG 26 - 12) with the appropriate crimp dies.

HBE 6 SCREWLESS SPRING CAGE CLAMP INSERTS

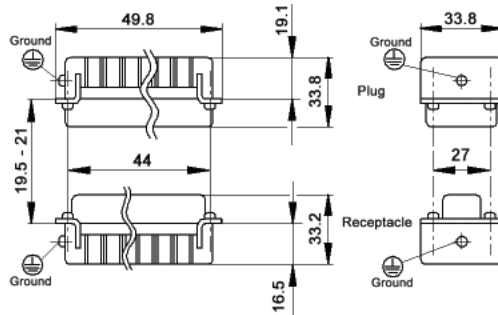

View from Cable Side

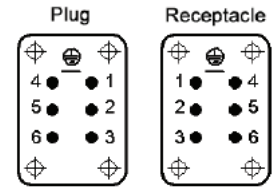

All dimensions are in mm.



Description	Plug	Receptacle
Screwless Cage Clamp	10400000	10401000

SCREW TERMINATED TERMINAL BLOCK INSERTS



View from Cable Side

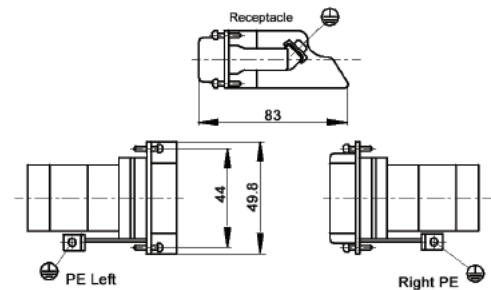
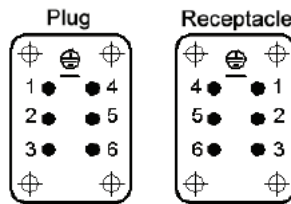

All dimensions are in mm.



Description	Receptacle
Terminal Block: Right Ground	70311100
Terminal Block: Left Ground	70310100

One terminal block insert mates with one screw terminated insert.

These terminal block inserts only fit in HBE 6 panel mount bases