

## BOARD LEVEL POWER SEMICONDUCTOR HEAT SINKS



### 634 SERIES Slim Profile Unidirectional Fin Vertical Mount Heat Sink

TO-220 and TO-218

Standard P/N	Plain Pin		Height Above PC Board in. (mm)	Footprint Dimensions in. (mm)	Weight lbs. (grams)
	With Pin	Without Pin			
634-10ABP ▲	634-10AB		1.000 (25.4)	0.640 (16.26) x 0.640 (16.26)	0.016 (7.48)
634-15ABP ▲	634-15AB		1.500 (38.1)	0.640 (16.26) x 0.640 (16.26)	0.025 (11.21)
634-20ABP ▲	634-20AB		2.000 (50.8)	0.640 (16.26) x 0.640 (16.26)	0.033 (14.95)

Material: Aluminum, Black Anodized.

These slim profile unidirectional fin heat sinks offer users two assembly alternatives for vertically mounting TO-220 and TO-218 components. Models are available with or without wave-

solderable pins on 0.40 in. (10.2) centers, making them ideal for a variety of applications where quick assembly is needed and space is at a premium.

### MECHANICAL DIMENSIONS

#### 634 SERIES

**Notes:**

1. Thermal compound is assumed between device and heat sink.
2. Tab temp with longer heat sink (634-20ABP) will typically be about 15% cooler. Tab temp with shorter heat sink (634-10ABP) will typically be about 25% higher.

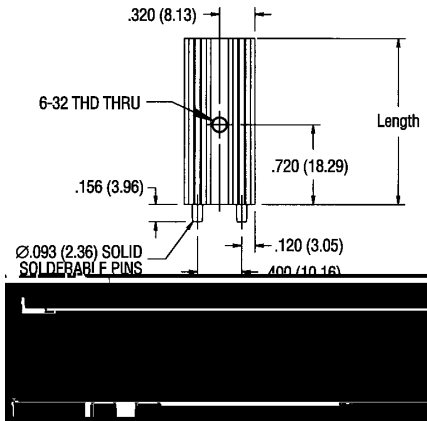

Dimensions: in. (mm)

### TYPICAL THERMAL PERFORMANCE FOR 634-15ABP

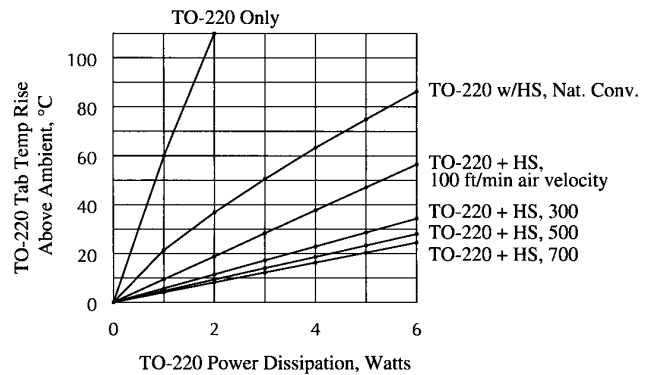

### 637 SERIES High-Efficiency Heat Sinks For Vertical Board Mounting

TO-220

Standard P/N	Height Above PC Board "A" in. (mm)	Maximum Footprint in. (mm)	Thermal Performance at Typical Load		Weight lbs. (grams)
			Natural Convection	Forced Convection	
637-10ABP ▲	1.000 (25.4)	1.375 (34.9) x 0.500 (12.7)	76°C @ 6W	5.8°C/W @ 200 LFM	0.023 (10.43)
637-15ABP ▲	1.500 (38.1)	1.375 (34.9) x 0.500 (12.7)	65°C @ 6w	5.5°C/W @ 200 LFM	0.035 (15.88)
637-20ABP ▲	2.000 (50.8)	1.375 (34.9) x 0.500 (12.7)	55°C @ 6W	4.7°C/W @ 200 LFM	0.050 (22.68)
637-25ABP ▲	2.500 (63.5)	1.375 (34.9) x 0.500 (12.7)	48°C @ 6W	4.2°C/W @ 200 LFM	0.062 (28.12)

Material: Aluminum, Black Anodized

Wave-solderable pins on 1 in. centers for vertical mounting on printed circuit boards. Maximum semiconductor package width 0.625 in. (15.9). Use this heat sink where weight

and board space occupied must be minimized. Refer to the Accessory products section for thermal interface materials, thermal compounds, and other accessories products.

### MECHANICAL DIMENSIONS

#### 637 SERIES (EXTRUSION PROFILE 5183)

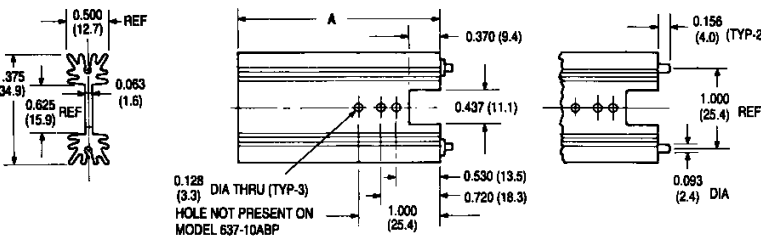

Dimensions: in. (mm)

### NATURAL AND FORCED CONVECTION CHARACTERISTICS

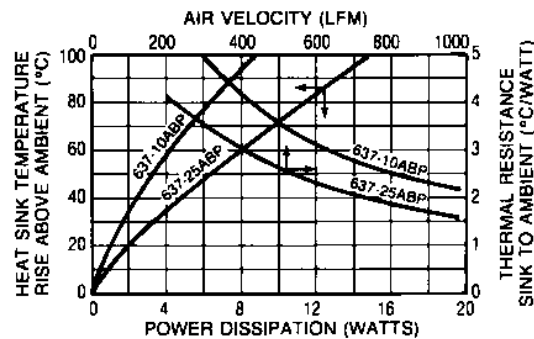

**BOARD LEVEL POWER SEMICONDUCTOR HEAT SINKS**



**667 SERIES Labor-Saving SpeedClip™ Heat Sinks for Vertical Board Mounting**

TO-220

Standoff Pin	Standard P/N Plain Pin	Height Above PC Board "A" in. (mm)	Maximum Footprint in. (mm)	Thermal Performance at Typical Load		Weight lbs (grams)
				Natural Convection	Forced Convection	
667-10ABSP ▲	667-10ABPP ▲	1.000 (25.4)	1.375 (34.9) x 0.500 (12.7)	76°C @ 6W	5.8°C/W @ 200 LFM	0.0240 (11.0)
667-15ABSP	667-15ABPP ▲	1.500 (38.1)	1.375 (34.9) x 0.500 (12.7)	66°C @ 6W	5.5°C/W @ 200 LFM	0.0340 (15.6)
667-20ABSP	667-20ABPP	2.000 (50.8)	1.375 (34.9) x 0.500 (12.7)	58°C @ 6W	4.7°C/W @ 200 LFM	0.0460 (21.0)
667-25ABSP	667-25ABPP	2.500 (63.5)	1.375 (34.9) x 0.500 (12.7)	48°C @ 6W	4.2°C/W @ 200 LFM	0.0580 (26.2)

Wave-solderable pins. Material: Aluminum, Black Anodized

Excellent performance, choice of wave-solderable plain pins (PP-Type) or wave-solderable hex-shaped standoff pins (SP-Type), and reduced assembly cost. Note: Order 330 SC or 285 SC SpeedClip™ separately.

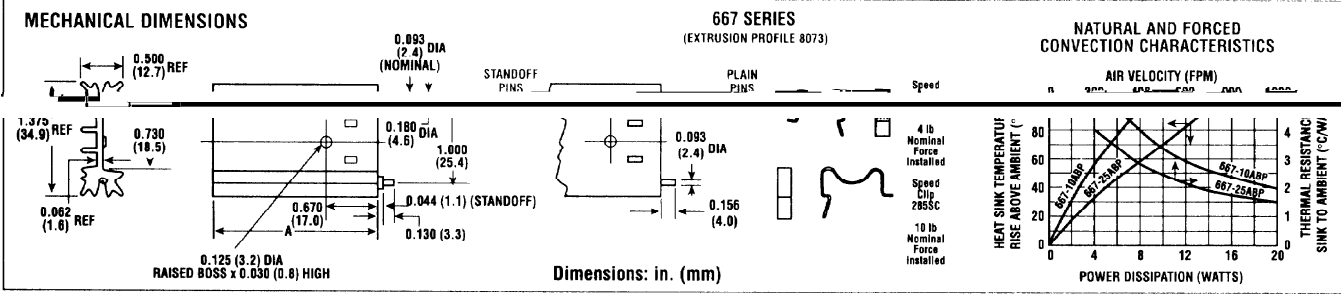

**285 AND 330 SERIES 285 SC and 330 SC SpeedClips™ for 667 Series Heat Sinks**

Standard P/N	Nominal Installed Loading Force	For Use With Series	Material	Weight lbs. (grams)
285 SC	10 lbs	232, 237, 240, 252, 667	Carbon Steel	0.00053 (0.24)
330 SC	4 lbs	232, 237, 240, 252, 667	Stainless Steel	0.00074 (0.34)

SpeedClips™ employ a locking safety tab for mounting. Must be ordered separately for these heat sink series. Use these SpeedClips™ with our 237, 240, 252, and 667 Series heat sinks

for the lowest production assembly time and cost. Order one SpeedClip™ for each 667 Series heat sink purchased.

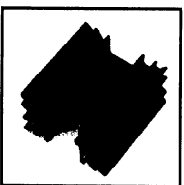
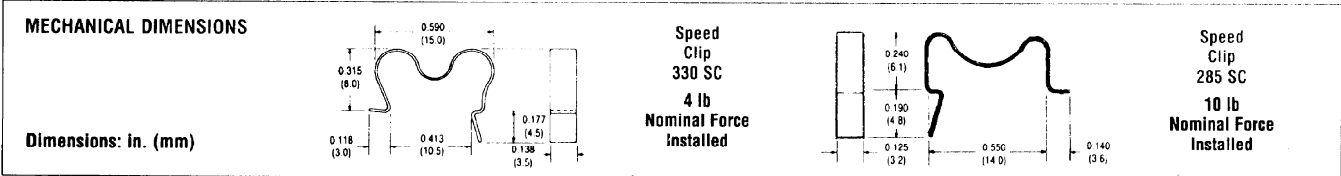

**647 SERIES High-Performance Heat Sinks for Vertical Board Mounting**

TO-220

Standard P/N	Height Above PC Board "A" in. (mm)	Maximum Footprint in. (mm)	Thermal Performance at Typical Load		Weight lbs. (grams)
			Natural Convection	Forced Convection	
647-10ABP ▲	1.000 (25.4)	1.650 (41.9) x 1.000 (25.4)	42°C @ 6W	3.8°C/W @ 200 LFM	0.055 (24.95)
647-15ABP ▲	1.500 (38.1)	1.650 (41.9) x 1.000 (25.4)	37°C @ 6W	3.5°C/W @ 200 LFM	0.075 (34.02)
647-175ABP	1.750 (44.5)	1.650 (41.9) x 1.000 (25.4)	34°C @ 6W	3.3°C/W @ 200 LFM	0.090 (40.82)
647-20ABP ▲	2.000 (50.8)	1.650 (41.9) x 1.000 (25.4)	31°C @ 6W	3.1°C/W @ 200 LFM	0.104 (47.17)
647-25ABP	2.500 (63.5)	1.650 (41.9) x 1.000 (25.4)	25°C @ 6W	2.8°C/W @ 200 LFM	0.125 (56.70)

Material: Aluminum, Black Anodized

Wave-solderable pins on 1 in. centers for vertical mounting of larger devices on printed circuit boards. Maximum semiconductor package width: 0.625 (15.9). Refer to the Accessory

Products section for thermal interface materials, 126 Series silicone-free thermal compounds, and other accessories products.

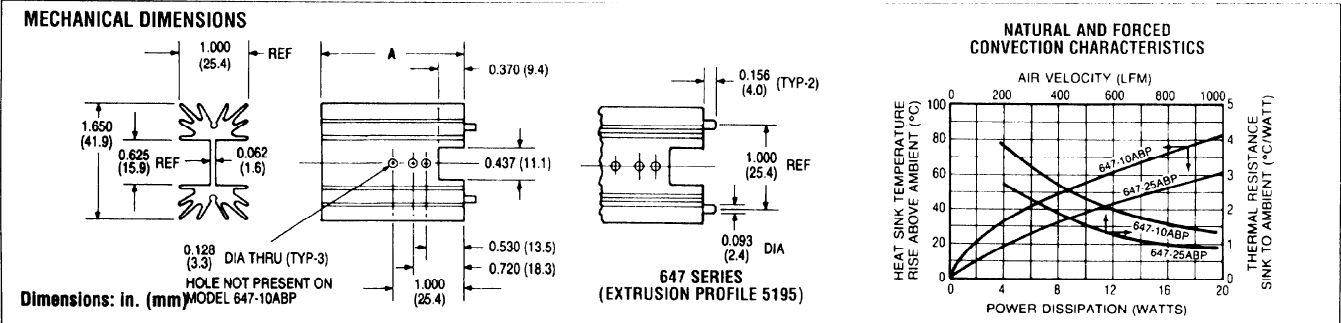

## BOARD LEVEL POWER SEMICONDUCTOR HEAT SINKS



626 AND 627 SERIES High-Efficiency Heat Sinks for Vertical Board Mounting

TO-218, TO-220

Standard P/N	Standard P/N	Height Above PC Board "A" in. (mm)	Maximum Footprint in. (mm)	Thermal Performance at Typical Load	
				Natural Convection	Forced Convection
626-10ABP	627-10ABP	1.000 (25.4)	1.375 (34.9) x .500 (12.7)	76°C @ 6W	5.8°C/W @ 200 LFM
626-15ABP	627-15ABP	1.500 (38.1)	1.375 (34.9) x .500 (12.7)	65°C @ 6W	5.5°C/W @ 200 LFM
626-20ABP	627-20ABP	2.000 (50.8)	1.375 (34.9) x .500 (12.7)	55°C @ 6W	4.7°C/W @ 200 LFM
626-25ABP	627-25ABP	2.500 (63.5)	1.375 (34.9) x .500 (12.7)	48°C @ 6W	4.2°C/W @ 200 LFM

Wave-solderable pins. Material: Aluminum, Black Anodized

### MECHANICAL DIMENSIONS

### 626 AND 627 SERIES

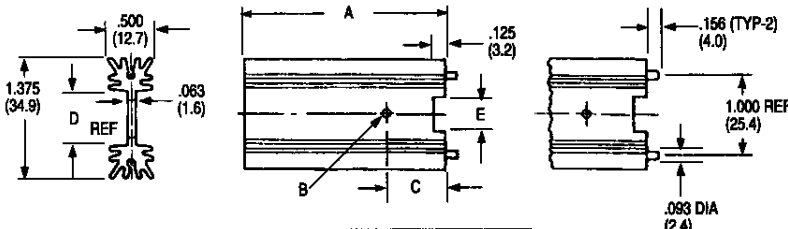

### NATURAL AND FORCED CONVECTION CHARACTERISTICS

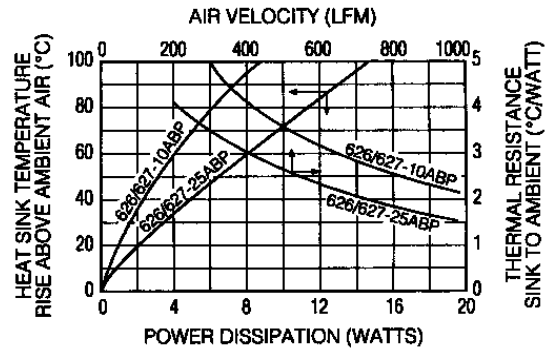

Series	Type Device	Hole Diameter "B"	Hole Height "C"	Webb Width "D"	Notch Width "E"	Extrusion Profile
626	TO-218	.144 (3.7)	.850 (21.6)	.660 (16.8)	.540 (13.7)	8420
627	TO-220	.128 (3.3)	.720 (18.3)	.625 (15.9)	.437 (11.1)	5183

Dimensions: in. (mm)

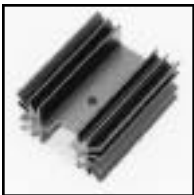

657 SERIES High-Performance Heat Sinks for Vertical Board Mounting

TO-220, TO-247, TO-218

Standard P/N	Height Above PC Board "A" in. (mm)	Maximum Footprint in. (mm)	Thermal Performance at Typical Load		Weight lbs (grams)
			Natural Convection	Forced Convection	
657-10ABP ▲	1.000 (25.4)	1.650 (41.9) x 1.000 (25.4)	41°C @ 6W	3.7°C/W @ 200 LFM	0.0515 (23.36)
657-15ABP ▲	1.500 (38.1)	1.650 (41.9) x 1.000 (25.4)	38°C @ 6W	3.3°C/W @ 200 LFM	0.0760 (34.60)
657-20ABP ▲	2.000 (50.8)	1.650 (41.9) x 1.000 (25.4)	32°C @ 6W	2.9°C/W @ 200 LFM	0.1030 (47.00)
657-25ABP ▲	2.500 (63.5)	1.650 (41.9) x 1.000 (25.4)	25°C @ 6W	2.7°C/W @ 200 LFM	0.1250 (57.00)

Wave-solderable pins. Material: Aluminum, Black Anodized

### MECHANICAL DIMENSIONS

### 657 SERIES

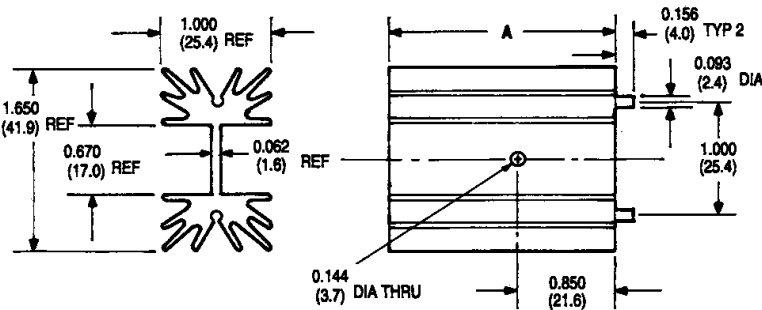

### NATURAL AND FORCED CONVECTION CHARACTERISTICS

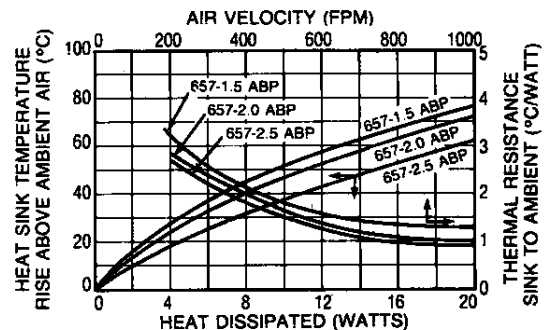

Dimensions: in. (mm)

657 SERIES  
(EXTRUSION PROFILE 6533)

## BOARD LEVEL POWER SEMICONDUCTOR HEAT SINKS

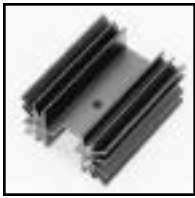

### 657 SERIES High-Performance Notched Heat Sinks for Vertical Board Mounting

TO-220, TO-247, TO-218

Standard P/N	Height Above PC Board "A" in. (mm)	Maximum Footprint in. (mm)	Thermal Performance at Typical Load	
			Natural Convection	Forced Convection
657-10ABPN	1.000 (25.4)	1.650 (41.9) x 1.000 (25.4)	41°C @ 6W	3.7°C/W @ 200 LFM
657-15ABPN ▲	1.500 (38.1)	1.650 (41.9) x 1.000 (25.4)	38°C @ 6W	3.3°C/W @ 200 LFM
657-20ABPN	2.000 (50.8)	1.650 (41.9) x 1.000 (25.4)	32°C @ 6W	2.9°C/W @ 200 LFM
657-25ABPN	2.500 (63.5)	1.650 (41.9) x 1.000 (25.4)	25°C @ 6W	2.7°C/W @ 200 LFM

Wave-solderable pins. Material: Aluminum, Black Anodized

#### MECHANICAL DIMENSIONS

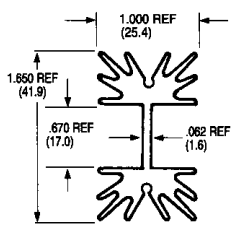

Dimensions: in. (mm)

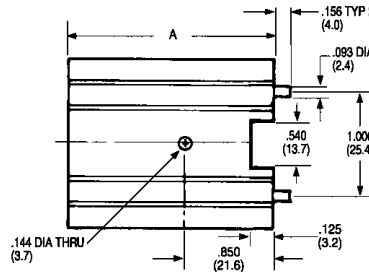

#### 657 SERIES

657 SERIES  
(EXTRUSION PROFILE 6533)

#### NATURAL AND FORCED CONVECTION CHARACTERISTICS

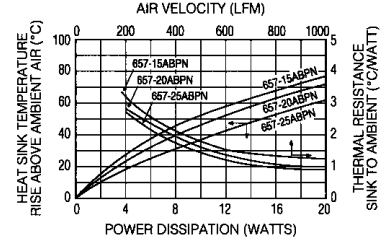

### 657 SERIES High-Performance Heat Sinks with SpeedClips™ for Vertical Board Mounting

TO-220, TO-247, TO-218

Standard P/N	Height Above PC Board "A" in. (mm)	Maximum Footprint in. (mm)	Thermal Performance at Typical Load	
			Natural Convection	Forced Convection
657-10ABPSC	1.000 (25.4)	1.650 (41.9) x 1.000 (25.4)	41°C @ 6W	3.7°C/W @ 200 LFM
657-15ABPSC	1.500 (38.1)	1.650 (41.9) x 1.000 (25.4)	38°C @ 6W	3.3°C/W @ 200 LFM
657-20ABPSC	2.000 (50.8)	1.650 (41.9) x 1.000 (25.4)	32°C @ 6W	2.9°C/W @ 200 LFM
657-25ABPSC ▲	2.500 (63.5)	1.650 (41.9) x 1.000 (25.4)	25°C @ 6W	2.7°C/W @ 200 LFM

Wave-solderable pins. Material: Aluminum, Black Anodized

#### MECHANICAL DIMENSIONS

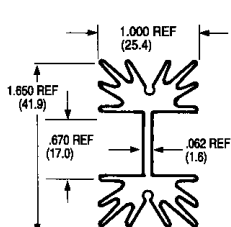

Dimensions: in. (mm)

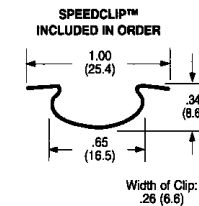
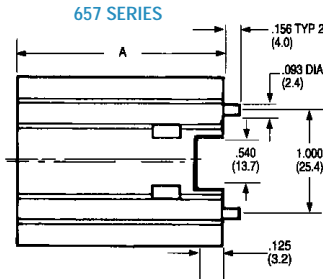

657 SERIES  
(EXTRUSION PROFILE 6533)

#### NATURAL AND FORCED CONVECTION CHARACTERISTICS

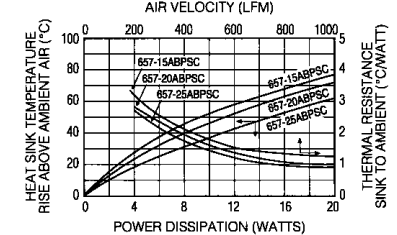

### 677 SERIES High-Performance, High-Power Heat Sinks for Vertical Board Mounting

TO-218, TO-220, TO-247  
15-LEAD Multiwatt

Standard P/N	Height Above PC Board "A" in. (mm)	Maximum Footprint in. (mm)	Thermal Performance at Typical Load	
			Natural Convection	Forced Convection
677-10ABP	1.000 (25.4)	1.650 (41.9) x 1.000 (25.4)	52°C @ 6W	3.1°C/W @ 200 LFM
677-15ABP	1.500 (38.1)	1.650 (41.9) x 1.000 (25.4)	46°C @ 6W	2.8°C/W @ 200 LFM
677-20ABP	2.000 (50.8)	1.650 (41.9) x 1.000 (25.4)	40°C @ 6W	2.5°C/W @ 200 LFM
677-25ABP	2.500 (63.5)	1.650 (41.9) x 1.000 (25.4)	35°C @ 6W	2.2°C/W @ 200 LFM

Wave-solderable pins. Material: Aluminum, Black Anodized

#### MECHANICAL DIMENSIONS

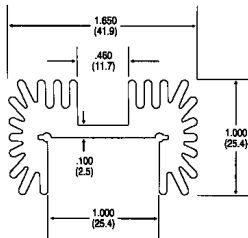

Dimensions: in. (mm)

#### 677 SERIES

677 SERIES  
(EXTRUSION PROFILE 8719)

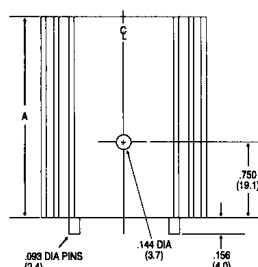

#### NATURAL AND FORCED CONVECTION CHARACTERISTICS

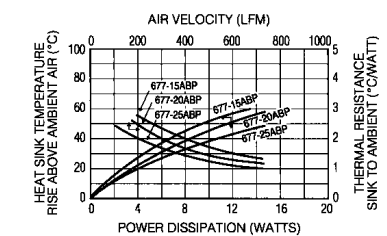

## BOARD LEVEL POWER SEMICONDUCTOR HEAT SINKS



### 690 SERIES Highest Efficiency/Lowest Unit Cost Heat Sinks

TO-3, TO-66, TO-220

Standard P/N	Height Above PC Board in. (mm)	Outline Dimensions in. (mm)	Thermal Performance at Typical Load		Semiconductor Mounting Hole Pattern	Weight lbs. (grams)
			Natural Convection	Forced Convection		
690-3B ▲	1.310 (33.3)	1.860 (47.2)-sq	44°C @ 7.5W	2.0°C/W @ 400 LFM	(1) TO-3	0.0700 (31.75)
690-66B	1.310 (33.3)	1.860 (47.2)-sq	44°C @ 7.5W	2.0°C/W @ 400 LFM	(1) TO-66	0.0700 (31.75)
690-220B	1.310 (33.3)	1.860 (47.2)-sq	44°C @ 7.5W	2.0°C/W @ 400 LFM	(2) TO-220	0.0700 (31.75)

Material: Aluminum, Black Anodized

These low-cost heat sinks provide the most power dissipation at the lowest unit cost and are available in three standard types to mount and cool one TO-3 or TO-66 metal power semiconductor type or two plastic package TO-220 power semiconductor types. For higher power

semiconductors, the 690 Series can dissipate up to 20 watts while maintaining a mounting surface temperature rise above ambient air temperature of no more than 91°C.

#### MECHANICAL DIMENSIONS

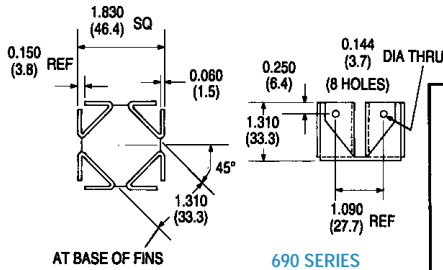

#### SEMICONDUCTOR MOUNTING HOLES

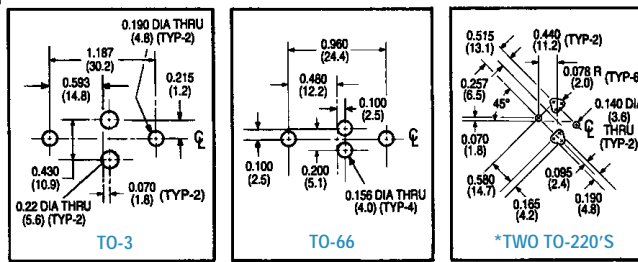

#### NATURAL AND FORCED CONVECTION CHARACTERISTICS

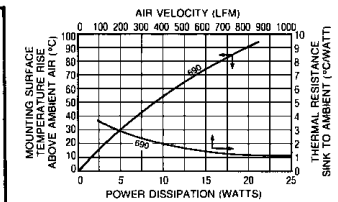

### 680 SERIES Maximum Efficiency Omnidirectional Heat Sinks

TO-3, TO-220

Standard P/N	Height Above PC Board "A" in. (mm)	Horizontal Mounting Footprint Dimensions in. (mm)	Thermal Performance at Typical Load		Semiconductor Mounting Hole Pattern	Weight lbs. (grams)
			Natural Convection	Forced Convection		
680-5A ▲	0.500 (12.7)	1.810 (46.0)-sq	70°C @ 7.5W	3.0°C/W @ 400 LFM	(1) TO-3	0.0700 (31.75)
680-75A ▲	0.750 (19.1)	1.810 (46.0)-sq	58°C @ 7.5W	2.4°C/W @ 400 LFM	(1) TO-3	0.0900 (40.82)
680-10A ▲	1.000 (25.4)	1.810 (46.0)-sq	52°C @ 7.5W	2.0°C/W @ 400 LFM	(1) TO-3	0.0980 (44.45)
680-125A ▲	1.250 (31.8)	1.810 (46.0)-sq	45°C @ 7.5W	1.5°C/W @ 400 LFM	(1) TO-3	0.1100 (49.90)
680-5220	0.500 (12.7)	1.810 (46.0)-sq	70°C @ 7.5W	3.0°C/W @ 400 LFM	(2) TO-220	0.0700 (31.75)
680-75220	0.750 (19.1)	1.810 (46.0)-sq	58°C @ 7.5W	2.4°C/W @ 400 LFM	(2) TO-220	0.0900 (40.82)
680-10220 ▲	1.000 (25.4)	1.810 (46.0)-sq	52°C @ 7.5W	2.0°C/W @ 400 LFM	(2) TO-220	0.0980 (44.45)
680-125220 ▲	1.250 (31.8)	1.810 (46.0)-sq	45°C @ 7.5W	1.5°C/W @ 400 LFM	(2) TO-220	0.1100 (49.90)

Material: Aluminum, Black Anodized

Achieve optimum natural convection cooling per unit volume occupied above the printed circuit board for TO-3 (one semiconductor package per heat sink) or for two TO-220 style cases, when this low-cost heat sink is used. Any mounting attitude will provide free circulation

of air in natural convection applications. These 680 Series heat sinks can also be specified without any semiconductor mounting hole pattern by specifying suffix "K" (Example: 680-5K).

#### MECHANICAL DIMENSIONS

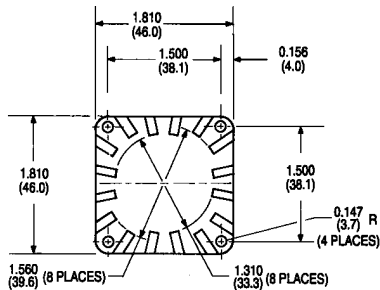

#### 680 SERIES

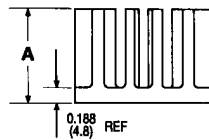

#### NATURAL AND FORCED CONVECTION CHARACTERISTICS

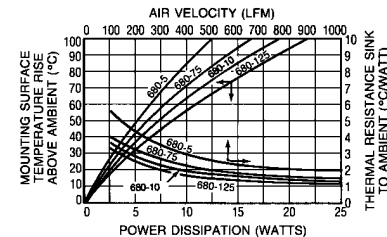

#### SEMICONDUCTOR MOUNTING HOLES

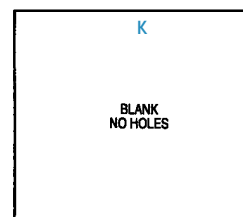
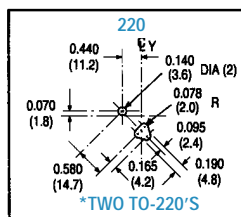
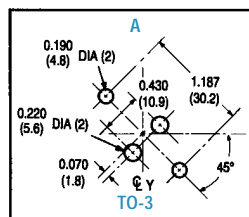

\*Only one hole pattern of two is shown. Hole patterns are symmetrical about the center lines.

## BOARD LEVEL POWER SEMICONDUCTOR HEAT SINKS



### 601 AND 603 SERIES Low-Height Heat Sinks

DO-4/DO-5 Diodes

Standard P/N	Footprint Dimensions in. (mm)	Height in. (mm)	Mounting Hole Dia. in. (mm)	Thermal Performance at Typical Load		Weight lbs. (grams)
				Natural Convection	Forced Convection	
601E	2.000 (50.8) x 1.250 (31.8)	0.562 (14.3)	0.200 (5.1)	52°C @ 5.0W	4.5°C/W @ 175 LFM	0.0500 (22.68)
601F	2.000 (50.8) x 1.250 (31.8)	0.562 (14.3)	0.270 (6.9)	52°C @ 5.0W	4.5°C/W @ 175 LFM	0.0500 (22.68)
601K	2.000 (50.8) x 1.250 (31.8)	0.562 (14.3)	None	52°C @ 5.0W	4.5°C/W @ 175 LFM	0.0500 (22.68)
603K	2.000 (50.8) x 2.000 (50.8)	0.562 (14.3)	None	41°C @ 5.0W	4.0°C/W @ 175 LFM	0.0810 (36.74)

Material: Aluminum Alloy, Black Anodized

Use these low-height heat sinks on printed circuit board applications for TO-66 power semiconductors and DO-4 and DO-5 diodes, where close board-to-board spacing and efficient

heat dissipation are required. The 601 and 603 Series may also be attached to enclosure panels or brackets using isolation hardware where necessary.

### MECHANICAL DIMENSIONS

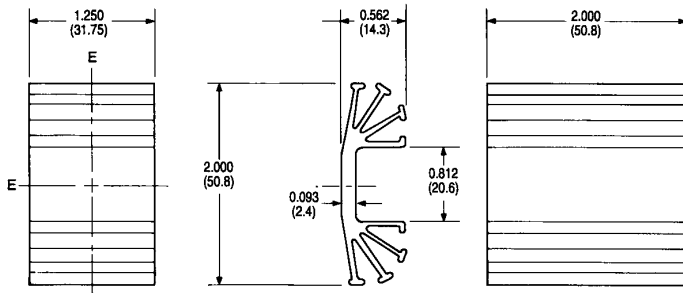

601 SERIES  
(EXTRUSION PROFILE 1284)

603 SERIES  
(EXTRUSION PROFILE 1284)

### SEMICONDUCTOR MOUNTING HOLES

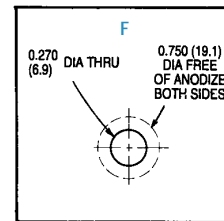
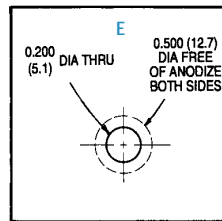
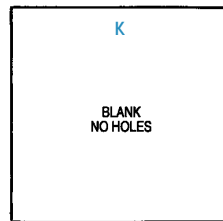

Dimensions: in. (mm)

E&F available on 601 Series only as a standard product.

### NATURAL AND FORCED CONVECTION CHARACTERISTICS

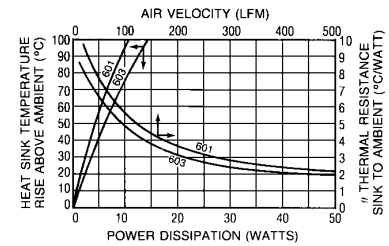

### 635 SERIES Space-Saving Low-Cost Heat Sinks

TO-3

Standard P/N	Height Above PC Board "A" in. (mm)	Outline Dimensions in. (mm)	Thermal Performance at Typical Load		Semiconductor Mounting Hole Pattern	Weight lbs. (grams)
			Natural Convection	Forced Convection		
635-5B2	0.500 (12.7)	1.900 (48.3) x 1.420 (36.0)	90°C @ 8.0W	6.0°C/W @ 300 LFM	TO-3	0.0200 (9.07)
635-75B2	0.750 (19.1)	1.900 (48.3) x 1.420 (36.0)	77°C @ 8.0W	4.8°C/W @ 300 LFM	TO-3	0.0220 (9.98)
635-10B2	1.000 (25.4)	1.900 (48.3) x 1.420 (36.0)	61°C @ 8.0W	3.6°C/W @ 300 LFM	TO-3	0.024 (10.89)
635-125B2	1.250 (31.8)	1.900 (48.3) x 1.420 (36.0)	53°C @ 8.0W	3.1°C/W @ 300 LFM	TO-3	0.028 (12.70)

Material: Aluminum Alloy, Black Anodized

Use this low-cost TO-3 heat sink style for multiple TO-3 applications on a single printed circuit board, where two or more TO-3s must be placed in proximity and minimum space is

available for heat sinking. Four different heights are available, all with TO-3 mounting hole pattern in the base. Consult factory for TO-66, TO-220, and multilead IC hole patterns.

### MECHANICAL DIMENSIONS

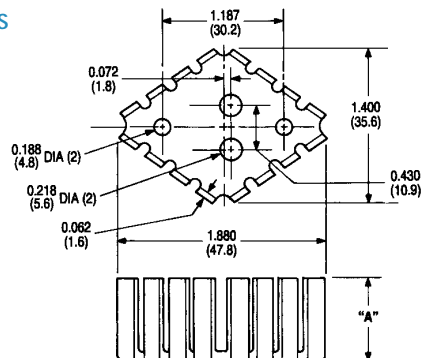

635 SERIES

Dimensions: in. (mm)

### NATURAL AND FORCED CONVECTION CHARACTERISTICS

