



PART NO.

TFCMF-20815B0T0

REVISIONS

ECN #	REV	DESCRIPTION	DRAWN	DATE	CHECKD	DATE	APPRVD	DATE
-	A	RELEASED	Hema	25/12/07	Priya P.K	27/12/07	G. C	10/01/08

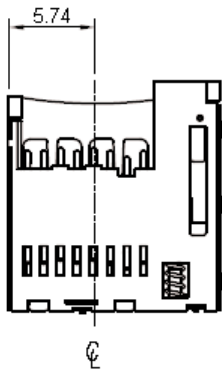
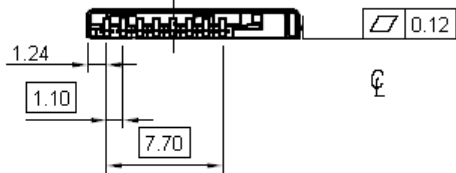
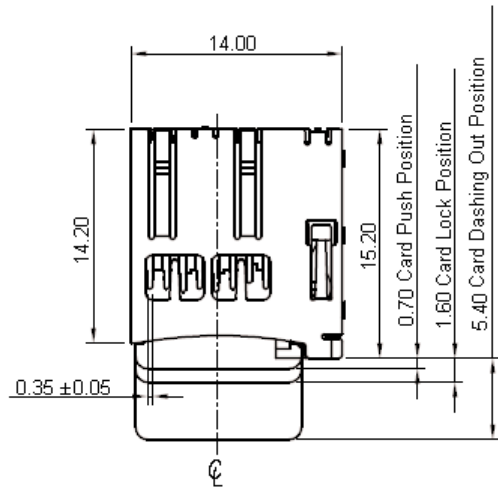

Dimensions : Millimetres

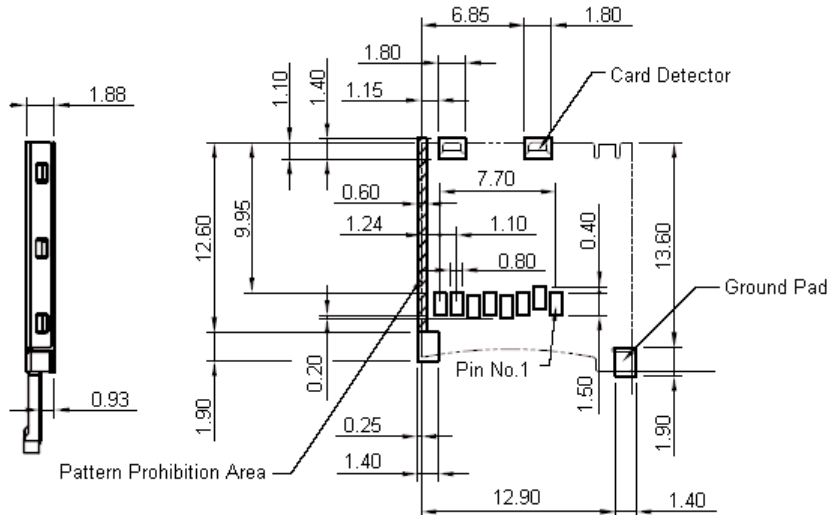

PC Board Layout (Top View)

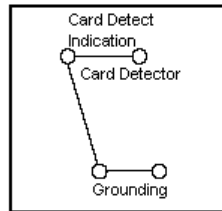
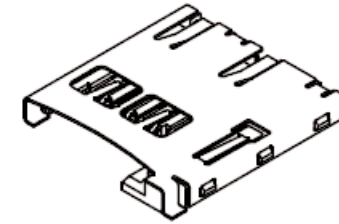

Without Card

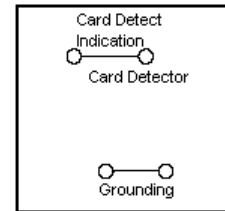

Card Inserted

Configuration

T-Flash	
Pin	Name
1	DAT2
2	CD/DAT3
3	CMD
4	VDD
5	CLK
6	VSS2
7	DAT0
8	DAT1

This data sheet and its contents (the "Information") belong to the Premier Farnell Group (the "Group") or are licensed to it. No licence is granted for the use of it other than for information purposes in connection with the products to which it relates. No licence of any intellectual property rights is granted. The Information is subject to change without notice and replaces all data sheets previously supplied. The Information supplied is believed to be accurate but the Group assumes no responsibility for its accuracy or completeness, any error in or omission from it or for any use made of it. Users of this data sheet should check for themselves the Information and the suitability of the products for their purpose and not make any assumptions based on information included or omitted. Liability for loss or damage resulting from any reliance on the Information or use of it (including liability resulting from negligence or where the Group was aware of the possibility of such loss or damage arising) is excluded. This will not operate to limit or restrict the Group's liability for death or personal injury resulting from its negligence. SPC MULTICOMP is the registered trademark of the Group. © Premier Farnell plc 2007.

TOLERANCES:

UNLESS OTHERWISE SPECIFIED, DIMENSIONS ARE FOR REFERENCE PURPOSES ONLY.

DRAWN BY:

Hema

CHECKED BY:

Priya P.K

APPROVED BY:

G.Cook

DATE:

25/12/07

DATE:

27/12/07

DATE:

10/01/08

DRAWING TITLE:

Memory Card Connector - Micro SD

SIZE
A

DWG NO.

M10000683

ELECTRONIC FILE

TFCMF-X08XXBXXX-C(XB)_DWG

REV

A

SCALE: NTS

U.O.M.: mm

SHEET: 1 OF 2



PART NO.

TFCMF-20815B0T0

REVISIONS

ECN #	REV	DESCRIPTION	DRAWN	DATE	CHECKD	DATE	APPRVD	DATE
-	A	RELEASED	Hema	25/12/07	Priya P.K	27/12/07	G. C	10/01/08

Specifications:

Material

- Housing : Themoplastic.
- Colour : Black.
- Push Bar :Themoplastic.
- Colour : Black.
- Contact : Phosphor bronze.
- Shell : SUS 304, t = 0.15m.
- Tin 100µ" at solder tail.

Part Number Table

Description	Part Number
Connector, Memory Card Micro SD	TFCMF-20815B0T0

Part Number Explanation

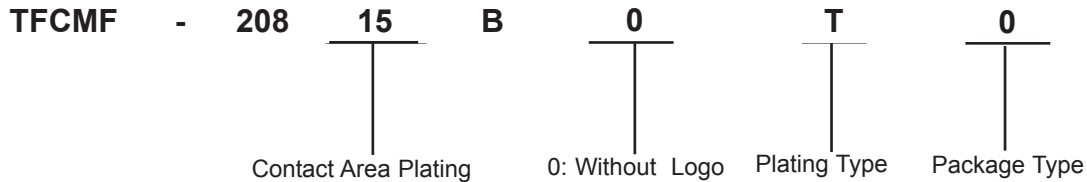

- Contact Area Plating : 15 = 15µ" Gold plating.
- Plating Type : T = Lead free.
- Package Type : 0 = Tray.

<http://www.farnell.com>
<http://www.newark.com>
<http://www.cpc.co.uk>

This data sheet and its contents (the "Information") belong to the Premier Farnell Group (the "Group") or are licensed to it. No licence is granted for the use of it other than for information purposes in connection with the products to which it relates. No licence of any intellectual property rights is granted. The Information is subject to change without notice and replaces all data sheets previously supplied. The Information supplied is believed to be accurate but the Group assumes no responsibility for its accuracy or completeness, any error in or omission from it or for any use made of it. Users of this data sheet should check for themselves the Information and the suitability of the products for their purpose and not make any assumptions based on information included or omitted. Liability for loss or damage resulting from any reliance on the Information or use of it (including liability resulting from negligence or where the Group was aware of the possibility of such loss or damage arising) is excluded. This will not operate to limit or restrict the Group's liability for death or personal injury resulting from its negligence. SPC MULTICOMP is the registered trademark of the Group. © Premier Farnell plc 2007.

TOLERANCES:

UNLESS OTHERWISE SPECIFIED, DIMENSIONS ARE FOR REFERENCE PURPOSES ONLY.

DRAWN BY:	DATE:
Hema	25/12/07
CHECKED BY:	DATE:
Priya P.K	27/12/07
APPROVED BY:	DATE:
G.Cook	10/01/08

DRAWING TITLE:			
Memory Card Connector - Micro SD			
SIZE	DWG NO.	ELECTRONIC FILE	REV
A	M10000683	TFCMF-X08XXBXXX-C(XB)_DWG	A
SCALE: NTS		U.O.M.: mm	SHEET: 2 OF 2