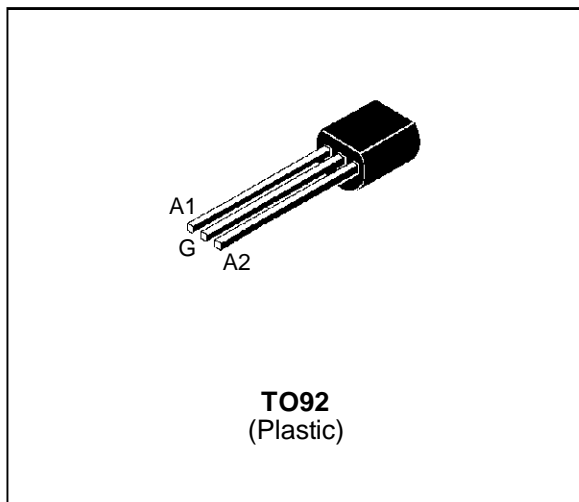

SENSITIVE GATE TRIACS
FEATURES

- $I_{T(RMS)} = 0.8A$
- $V_{DRM} = 400V$ to $800V$
- $I_{GT} \leq 3mA$ to $\leq 25mA$

DESCRIPTION

The Z01xxxA series of triacs uses a high performance TOP GLASS PNP technology. These parts are intended for general purpose applications where gate high sensitivity is required.

ABSOLUTE RATINGS (limiting values)

Symbol	Parameter	Value	Unit
$I_{T(RMS)}$	RMS on-state current (360° conduction angle)	$T_I = 70\text{ }^\circ\text{C}$ 0.8	A
I_{TSM}	Non repetitive surge peak on-state current (T_j initial = 25°C)	$t_p = 8.3\text{ ms}$	8.5
		$t_p = 10\text{ ms}$	8
I^2t	I^2t Value for fusing	$t_p = 10\text{ ms}$ 0.32	A^2s
di/dt	Critical rate of rise of on-state current $I_G = 50\text{ mA}$ $di_G/dt = 0.1\text{ A}/\mu\text{s}$.	Repetitive $F = 50\text{ Hz}$	10
		Non Repetitive	50
T_{stg} T_j	Storage and operating junction temperature range	- 40, + 150 - 40, + 125	$^\circ\text{C}$
T_I	Maximum lead temperature for soldering during 10s at 2mm from case	260	$^\circ\text{C}$

Symbol	Parameter	Voltage				Unit
		D	M	S	N	
V_{DRM} V_{RRM}	Repetitive peak off-state voltage $T_j = 125^\circ\text{C}$	400	600	700	800	V

Z01xxxA

THERMAL RESISTANCES

Symbol	Parameter	Value	Unit
Rth(j-a)	Junction to ambient	150	°C/W
Rth(j-l)	Junction to leads for D.C	80	°C/W
Rth(j-l)	Junction to leads for A.C 360° conduction angle (F=50Hz)	60	°C/W

GATE CHARACTERISTICS (maximum values)

$P_G (AV) = 0.1 W$ $P_{GM} = 2 W$ ($t_p = 20 \mu s$) $I_{GM} = 1 A$ ($t_p = 20 \mu s$)

ELECTRICAL CHARACTERISTICS

Symbol	Test Conditions		Quadrant		Sensitivity				Unit
					03	07	09	10	
I _{GT}	V _D =12V (DC) R _L =140Ω	T _j = 25°C	I-II-III	MAX	3	5	10	25	mA
			IV	MAX	5	7	10	25	
V _{GT}	V _D =12V (DC) R _L =140Ω	T _j = 25°C	I-II-III-IV	MAX	1.5				V
V _{GD}	V _D =V _{DRM} R _L =3.3kΩ	T _j = 125°C	I-II-III-IV	MIN	0.2				V
t _{gt}	V _D =V _{DRM} I _G = 40mA I _T = 1.1A dI _G /dt = 0.5A/μs	T _j = 25°C	I-II-III-IV	TYP	2				μs
I _H *	I _T = 50 mA Gate open	T _j = 25°C		MAX	7	10	10	25	mA
I _L	I _G = 1.2 I _{GT}	T _j = 25°C	I-III-IV	TYP	7	10	10	25	mA
			II	TYP	14	20	20	50	
V _{TM} *	I _{TM} = 1.1A t _p = 380μs	T _j = 25°C		MAX	1.5				V
I _{DRM} I _{RRM}	V _D = V _{DRM} V _R = V _{RRM}	T _j = 25°C		MAX	10				μA
		T _j = 110°C		MAX	200				
dV/dt*	V _D =67%V _{DRM} Gate open	T _j = 110°C		MIN	10	20	50	100	V/μs
				TYP	20	50	150	400	
(dV/dt) _c *	(dI/dt) _c = 0.35 A/ms	T _j = 110°C		MIN			2	5	V/μs
				TYP	1	1			

* For either polarity of electrode A₂ voltage with reference to electrode A₁

ORDERING INFORMATION

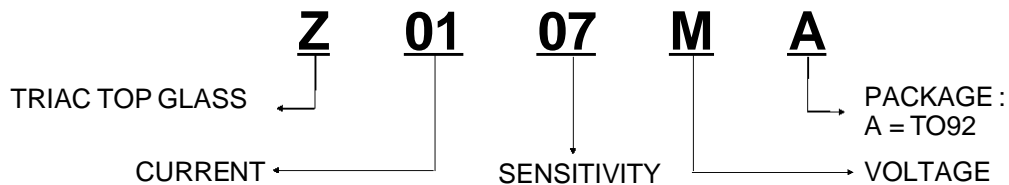

Fig.1 : Maximum RMS power dissipation versus RMS on-state current.

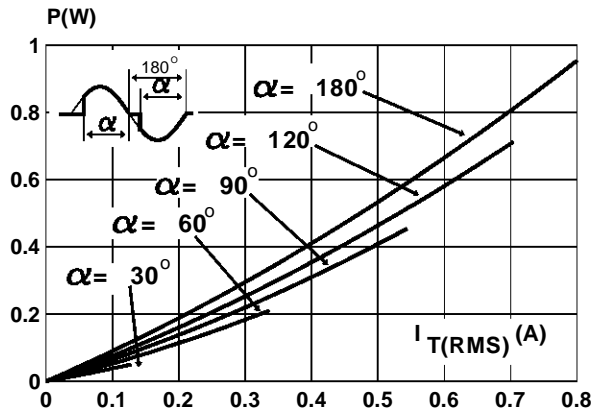

Fig.2 : Correlation between maximum RMS power dissipation and maximum allowable temperature (Tamb and Tlead).

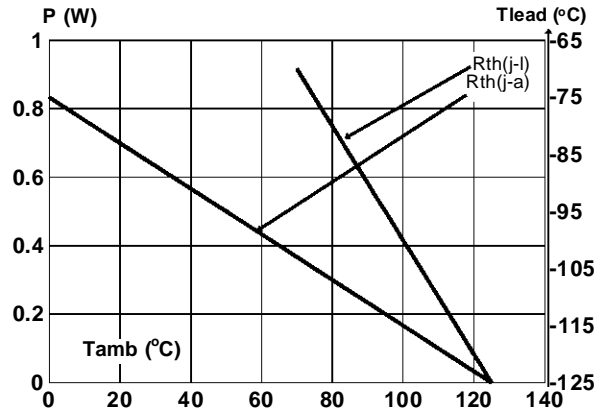

Fig.3 : RMS on-state current versus case temperature.

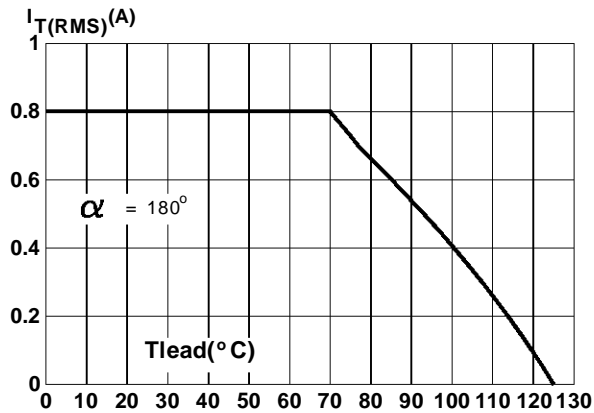

Fig.4 : Relative variation of thermal impedance junction to ambient versus pulse duration.

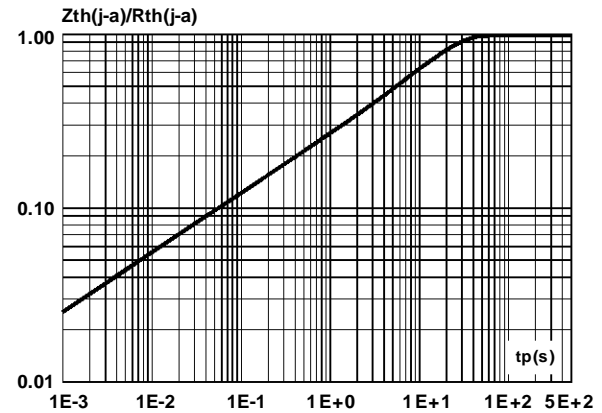

Fig.5 : Relative variation of gate trigger current and holding current versus junction temperature.

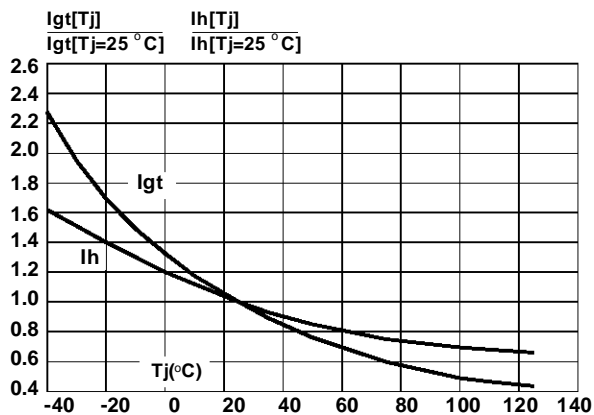
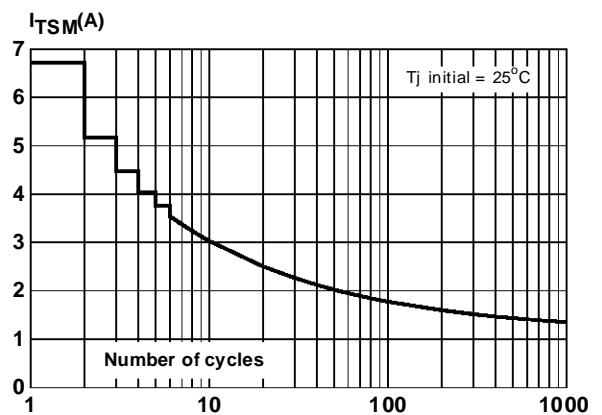

Fig.6 : Non repetitive surge peak on-state current versus number of cycles.



Z01xxxA

Fig.7 : Non repetitive surge peak on-state current for a sinusoidal pulse with width : $t_p \leq 10\text{ms}$, and corresponding value of I^2t .

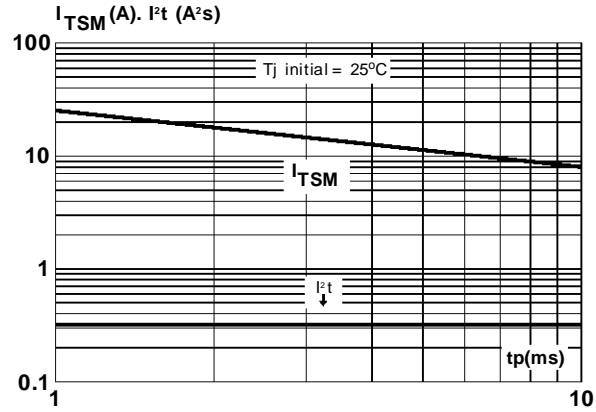
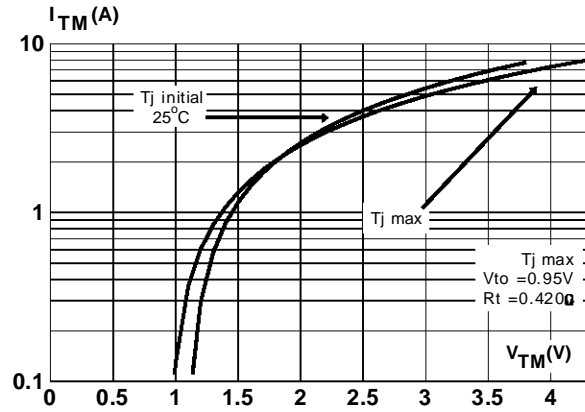
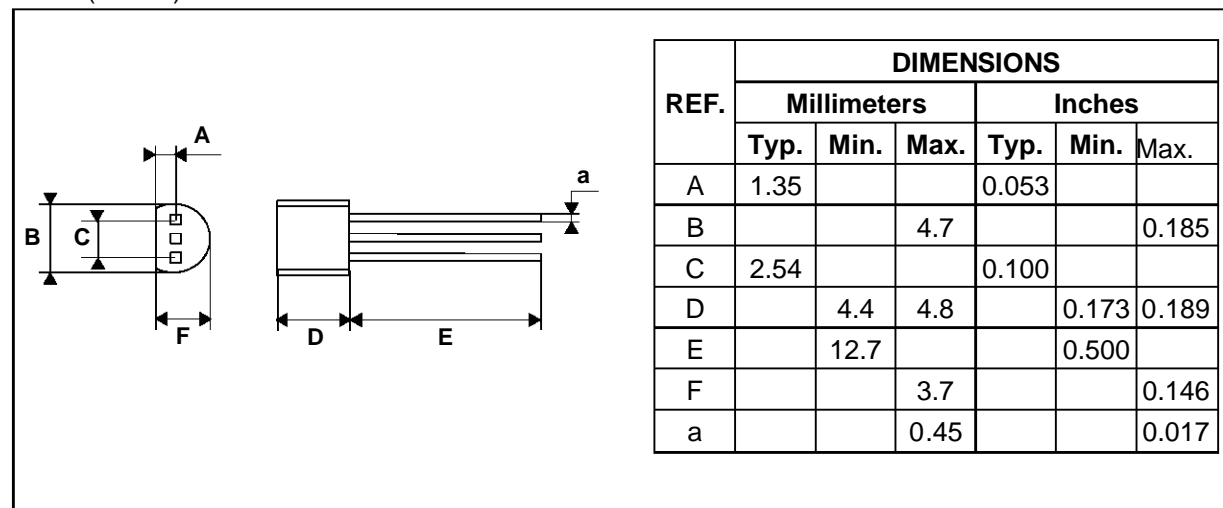

Fig.8 : On-state characteristics (maximum values).



PACKAGE MECHANICAL DATA

TO92 (Plastic)



Marking : type number

Weight : 0.2 g

Information furnished is believed to be accurate and reliable. However, SGS-THOMSON Microelectronics assumes no responsibility for the consequences of use of such information nor for any infringement of patents or other rights of third parties which may result from its use. No license is granted by implication or otherwise under any patent or patent rights of SGS-THOMSON Microelectronics. Specifications mentioned in this publication are subject to change without notice. This publication supersedes and replaces all information previously supplied. SGS-THOMSON Microelectronics products are not authorized for use as critical components in life support devices or systems without express written approval of SGS-THOMSON Microelectronics.

© 1995 SGS-THOMSON Microelectronics - All rights reserved.

SGS-THOMSON Microelectronics GROUP OF COMPANIES

Australia - Brazil - France - Germany - Hong Kong - Italy - Japan - Korea - Malaysia - Malta - Morocco - The Netherlands
Singapore - Spain - Sweden - Switzerland - Taiwan - Thailand - United Kingdom - U.S.A.